

DE5L60A

Fast Recovery Diodes

600V, 5A

Feature

- SMD
- High Voltage
- Low Noise
- Pb free terminal
- RoHS:Yes

OUTLINE

Package (House Name): E-pack

Package (JEITA Code): SC-63



Equivalent circuit

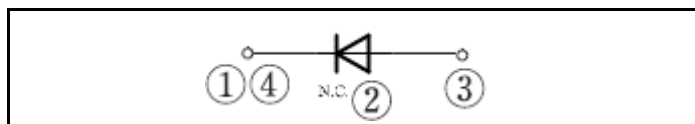

Absolute Maximum Ratings (unless otherwise specified : T_c=25°C)

Item	Symbol	Conditions	Ratings	Unit
Storage temperature	T _{stg}		-55 to 150	°C
Junction temperature	T _j		150	°C
Repetitive peak reverse voltage	V _{RRM}		600	V
Average forward current	I _{F(AV)}	50Hz sine wave, Resistance load, T _c =119°C	5	A
Surge forward current	I _{FSM}	50Hz sine wave, Non-repetitive 1 cycle, Peak value, T _j =25°C	60	A
Surge forward current	I _{FSM1}	t _p =1ms, Sine wave, Non-repetitive, Peak value, T _j =25°C	110	A

※ :See the original Specifications

Electrical Characteristics (unless otherwise specified : Tc=25°C)

Item	Symbol	Conditions	Ratings			Unit
			MIN	TYP	MAX	
Forward voltage	V _F	I _F =5.0A, Pulse measurement			2	V
Reverse current	I _R	V _R =600V, Pulse measurement			10	μA
Reverse recovery time	t _{rr}	I _F =0.5A, I _R =1.0A, 0.1I _R			50	ns
Total capacitance	C _t	f=1MHz, V _R =10V		33		pF
Thermal resistance	R _{th(j-c)}	Junction to case			4	°C/W

* :See the original Specifications

CHARACTERISTIC DIAGRAMS

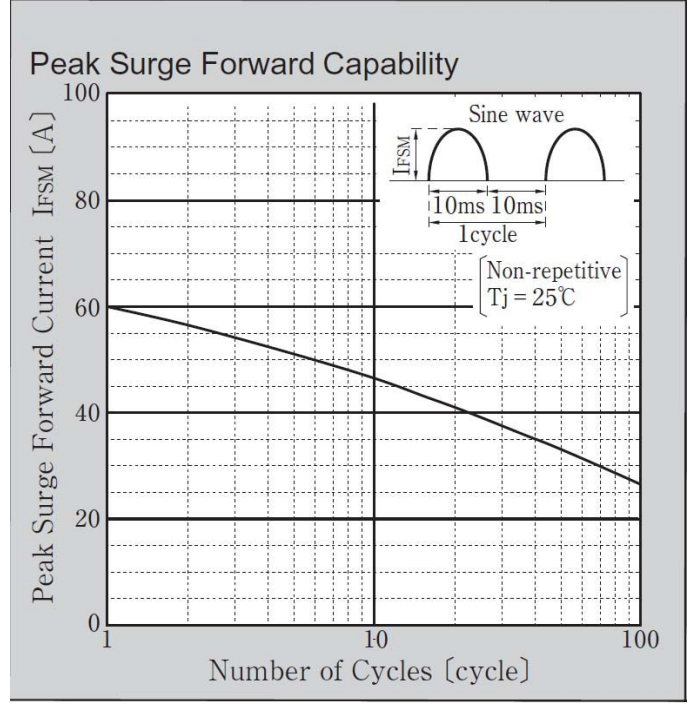
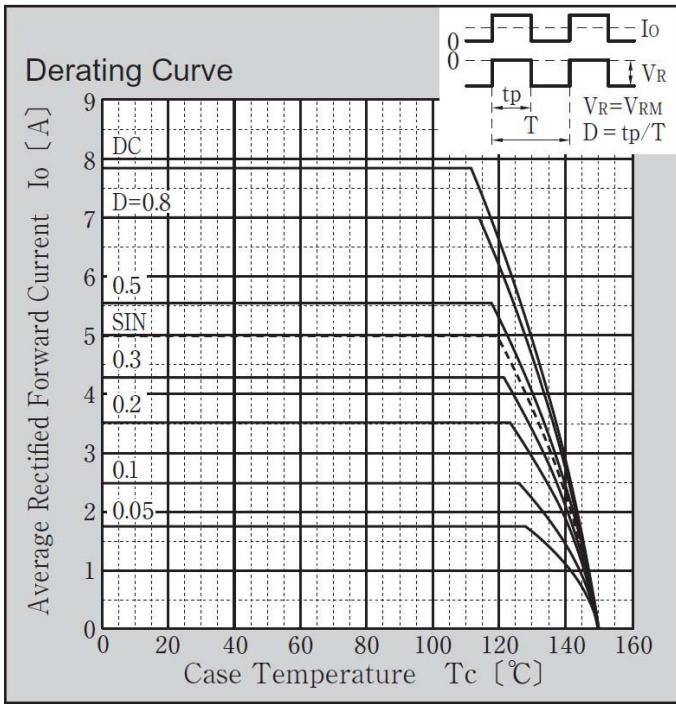
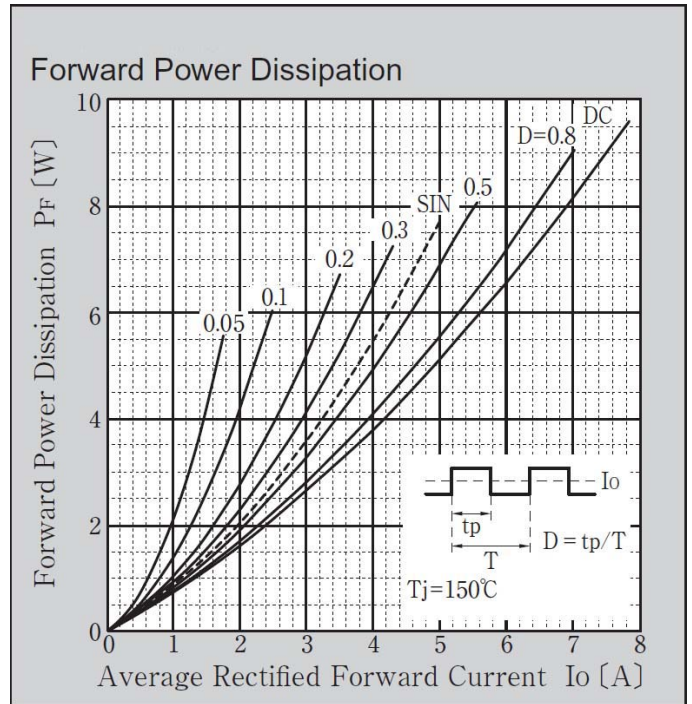
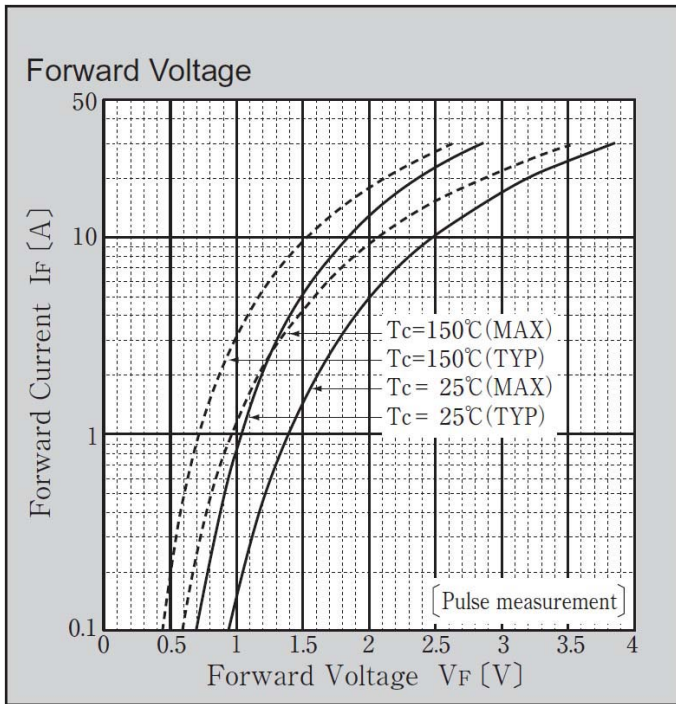

Peak Surge Forward Capability

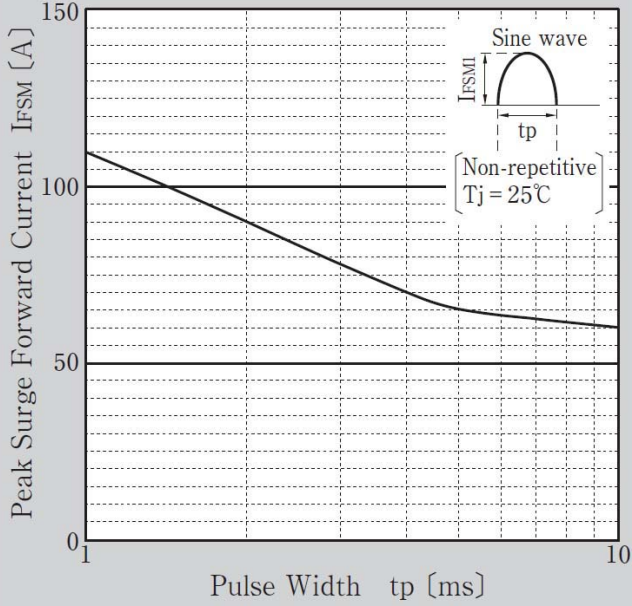

Peak Surge Forward Current Derating vs Junction Temperature

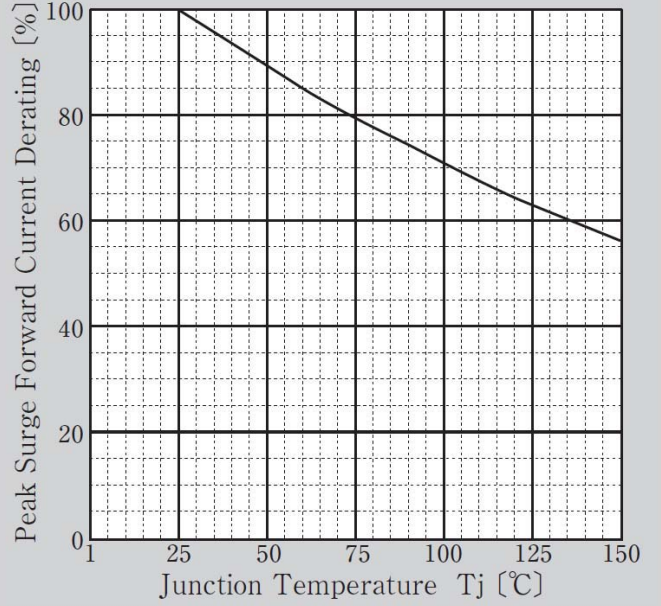

Junction Capacitance

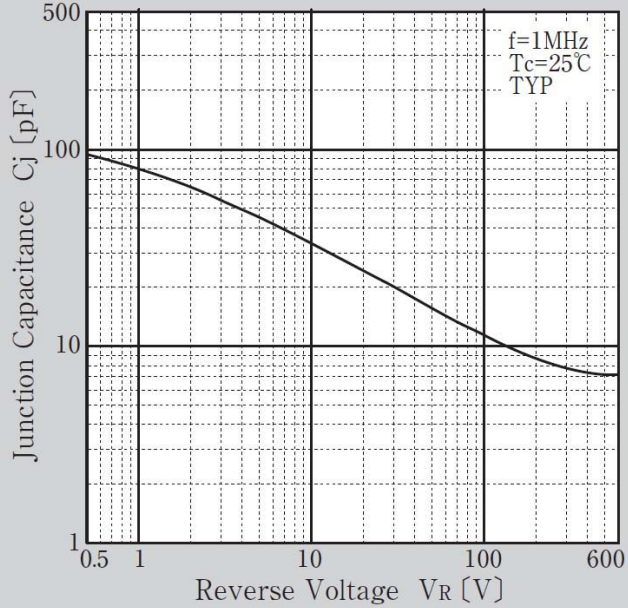

Transient Thermal Impedance

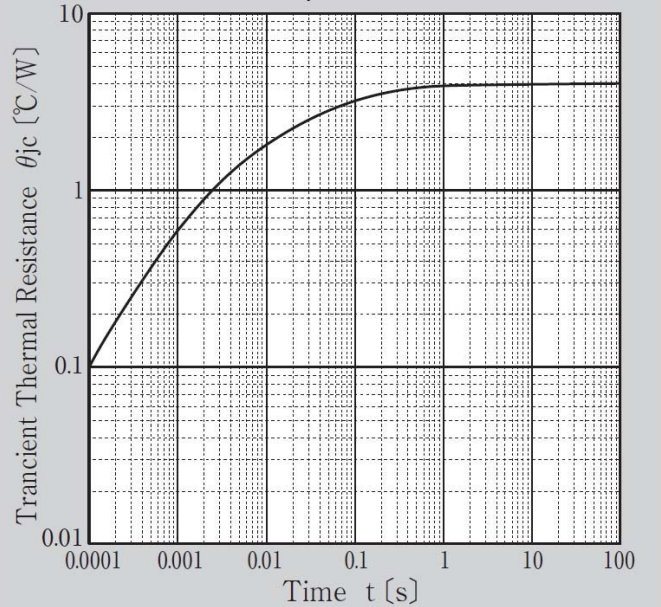

G1

JEDEC Code	-
JEITA Code	SC-63
House Name	E-pack

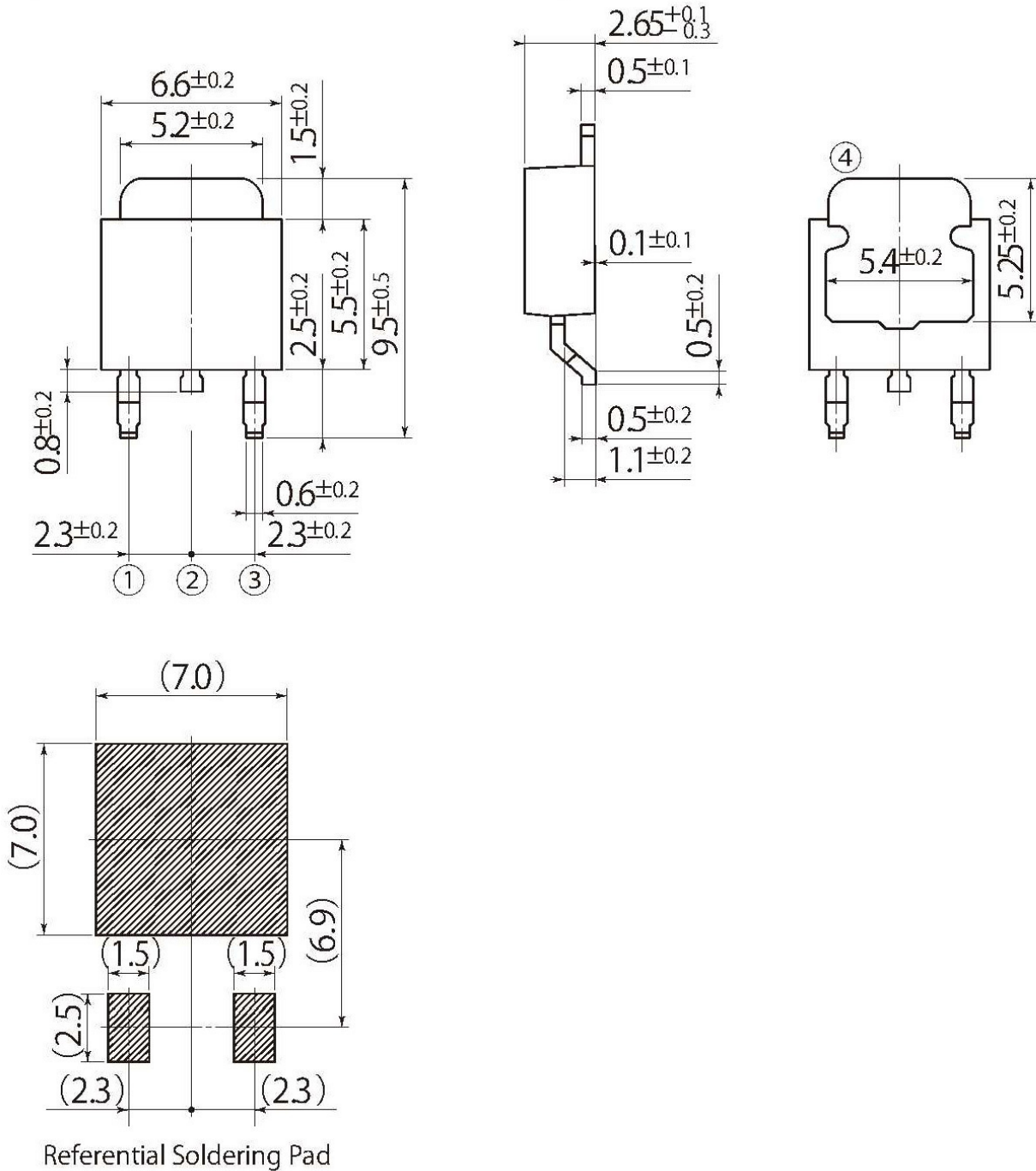

• Optimize soldering pad to the board design and soldering condition.