

Demoboard BTF3xxxEJ User Manual V1.0

About this document

Scope and purpose

This document describes how to use the Demoboard BTF3xxxEJ.

Intended audience

Engineers, hobbyists and students who want to switch 12V loads in their Arduino/XMC1100 kit projects.

Table of Contents

About this document.....	1
Table of Contents	2
1 Getting Started.....	3
1.1 BTF3xxxEJ Shield overview.....	3
1.2 Key features.....	3
1.3 Demoboard package contents	3
1.4 Typical connection	4
1.4.1 With Arduino Shield	4
1.4.2 Without Arduino shield (For Oscilloscope monitoring)	4
2 Demoboard configuration.....	5
2.1 Status pin connection	5
2.2 Enable pin connection	5
2.3 Slew Rate pin configuration.....	5
3 Software utilisation	5
3.1 Installation.....	5
3.2 Features.....	6
3.2.1 Monitoring Panel.....	6
3.2.2 Control Panel.....	6
3.2.3 Alternative Command.....	7
4 Board connectors description	8
4.1 Power connectors	8
4.2 ARDUINO/XMC1100 connectors.....	8
4.2.1 Connector SV1	8
4.2.2 Connector SV2.....	8
4.2.3 Connector SV3.....	9
4.2.4 Connector SV4.....	9
4.3 Test points	9
5 Schematic	10
6 B.O.M.	11
7 Board Layout.....	12
7.1 TOP.....	12
7.2 BOTTOM.....	12
7.3 MECHANICAL VIEW	15

1 Getting Started

1.1 BTF3xxxEJ Shield overview

The 12V low-side switch demoboard with one BTF3xxxEJ from Infineon Technologies is a flexible evaluation board dedicated to drive all kinds of loads. This demoboard is compatible with Arduino UNO shield and Infineon XMC1100.

The demoboard can be controlled either with the general logic I/O-ports of a microcontroller or with a PWM. It includes typical schematic to control the BTF3xxxEJ. This shield offers a quick evaluation of the product, the “Status” latch functionality, the “SRP” functionality, the “ENABLE” functionality, the “I_lim_trigger” functionality, the turn-ON in inverse current condition functionality, and all protections, e.g. “Over temperature shut down” and “Dynamic temperature protection”.

WARNING: Please refer to BTFxxxEJ Datasheet for details on functionalities and parameters values. This user manual does not replace the datasheet and user must be aware of limitations before turning on any supply.

The demoboard can be easily connected to any Arduino UNO board or Infineon XMC1100 via headers.

Code and graphic interface is available for Arduino UNO.

No code/interface is available for XMC1100, but XMC1100 can be easily programmed through Arduino IDE: please check the following link for details: <https://github.com/Infineon/XMC-for-Arduino>

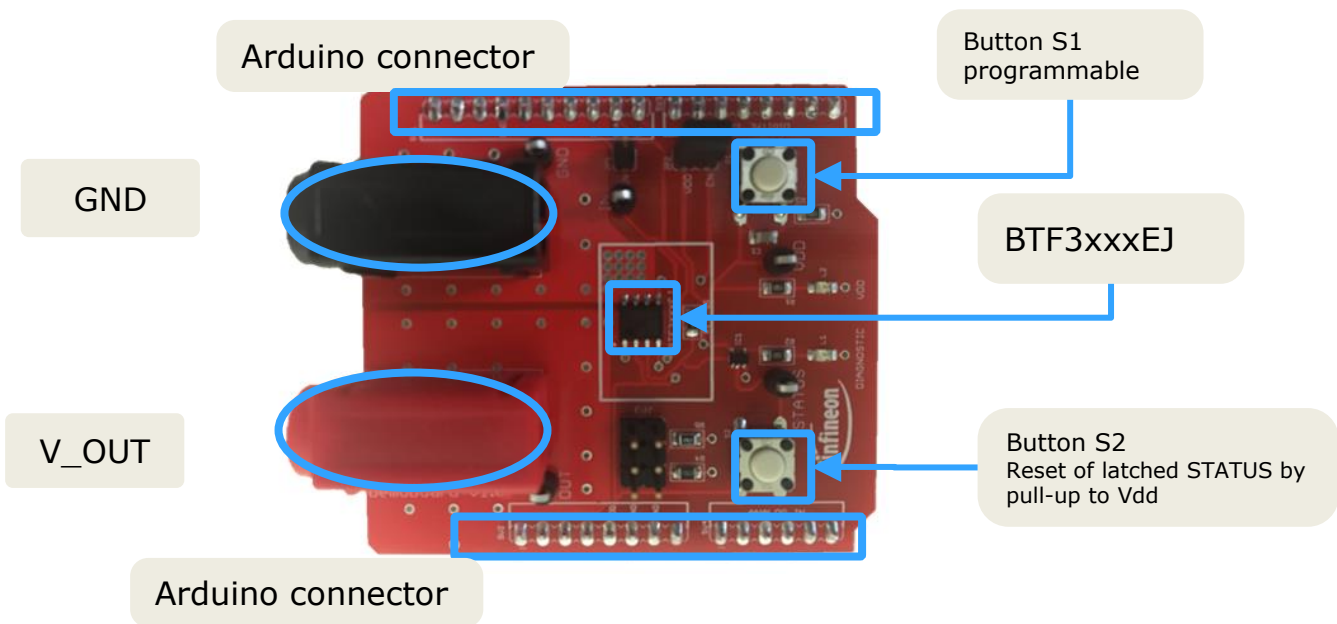

1.2 Key features

- Demoboard is able to provide continuous current load (30V- 15A) between V_OUT and GND.
- A green LED will turn ON when logic supply voltage is connected and ON.
- Output voltage, Input logic, Status and Logic voltage can be measured externally with test points.
- Input logic, Status can be monitored with the Arduino Interface.

1.3 Demoboard package contents

In the zip package must be the following:

- Demoboard_BTF3xxxEJ_User_Manual_Vx.x
- Demoboard_Aiko_Universal.exe
- Demoboard_Aiko_Universal.ino

1.4 Typical connection

1.4.1 With Arduino Shield

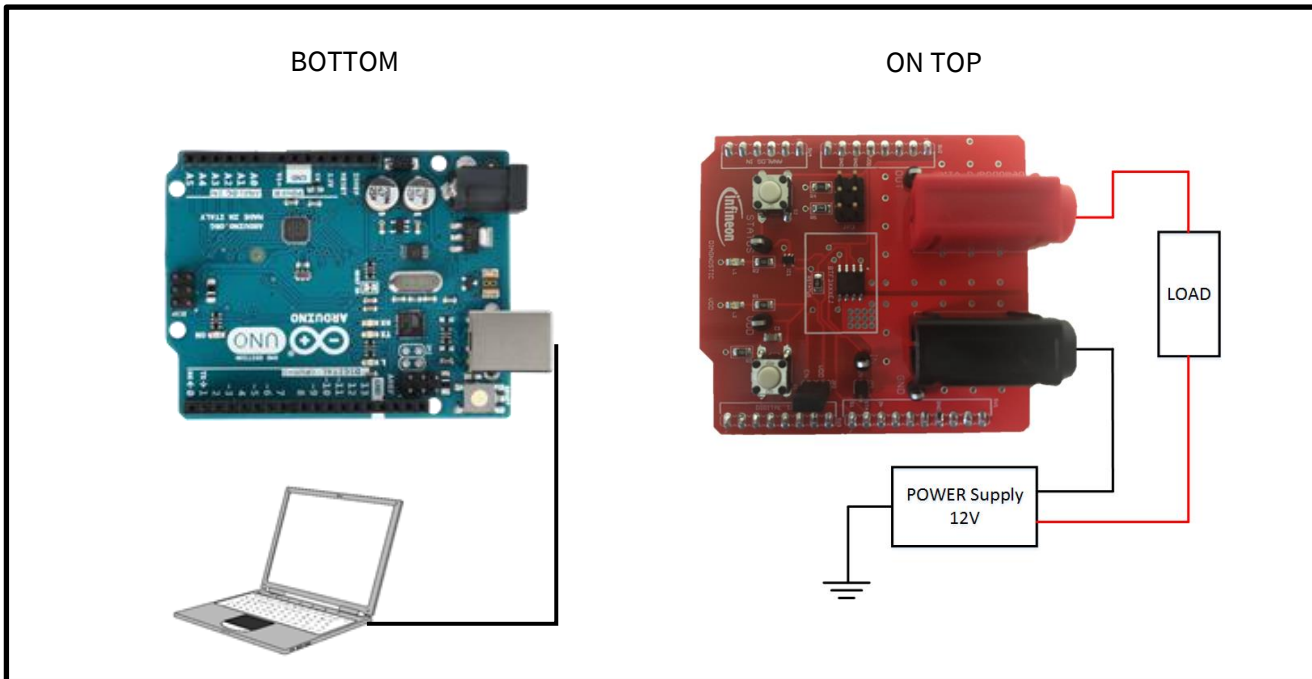

1.4.2 Without Arduino shield (For Oscilloscope monitoring)

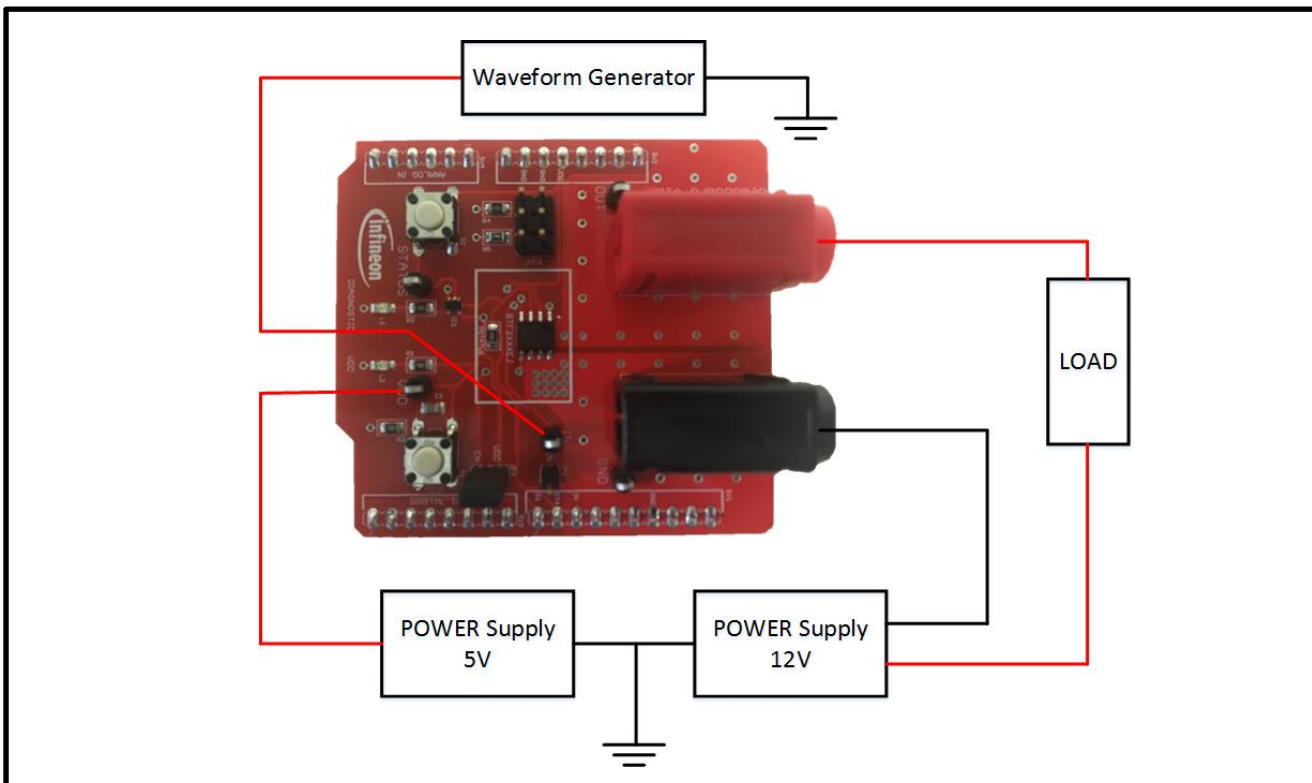

2 Demoboard configuration

- If an Arduino board is used, configuration needs to be set in the software. Please refer to **Error! Reference source not found. Error! Reference source not found.** command, where parameters of used demoboard can be selected.

2.1 Status pin connection

- BTF3xxxEJ has STATUS pin pulled-up to Vdd to allow fault monitoring, and fault reset
- Status pin can be reset via the GUI interface.
- If no diagnosis is needed, the Status pin can be connected to the Input pin via permanent pressure on S2 button. This will light LED L1.

2.2 Enable pin connection

- BTF3xxxEJ has an ENABLE pin. When switched off, it guarantees a very low leakage on drain and Vdd. It also reset status and I_lim_trigger
- You can ENABLE (pull-up to Vdd) or disable the device (pin open) with a jumper.
- Enable can also be turned ON/OFF via the GUI interface.

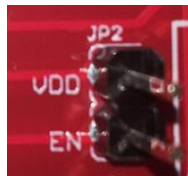

2.3 Slew Rate pin configuration

- Use jumper to choose SRP resistor value from GND to 58kΩ. Values of SMD resistors on the boards are the same that are characterized in the Datasheet (GND, 5.8kΩ, 58kΩ, open). Use jumper accordingly.

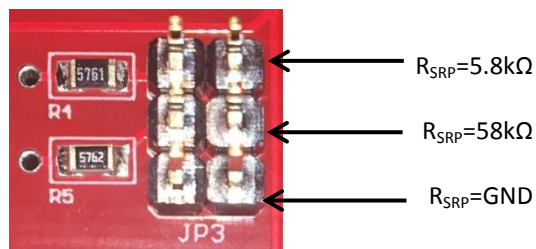

3 Software utilisation

- Software “*Demoboard_Aiko_Universal.exe*” is a GUI for Windows OS, used with the Arduino UNO board with the dedicated code “*Demoboard_Aiko_Universal.ino*”.

3.1 Installation

- User has to install the Arduino IDE software to allow communication between computer and Arduino board.
- Once the program is installed, connect the Arduino shield. Double-click the “*Demoboard_Aiko_Universal.ino*” Arduino code and upload it.

- When the code is correctly uploaded/ installed, the user can plug the demoboard on the Arduino shield. The green LED must turn on, meaning that BTF3xxxEJ logic is supplied.
- A message 'Done uploading' is displayed in Arduino IDE.
- Then, launch "Demoboard_aiko_Universal.exe".
 - Click on "Ports" to select the right communication port on your Arduino board.
 - Click on "Start" to start the system.
 - If it's not working, check your port name.
 - Port name is usually called "COM X", where "X" is a number.
 - If installation is done and operational, a green box is displayed above the Start and Stop buttons in the GUI Overview page. A red box shows a malfunction communication, in which case close the program, upload again and start again.
- When user wants to turn OFF the application, user has to click on "Stop" before closing the windows (none application can be shut down before closing the communication with the Arduino board).

3.2 Features

3.2.1 Monitoring Panel

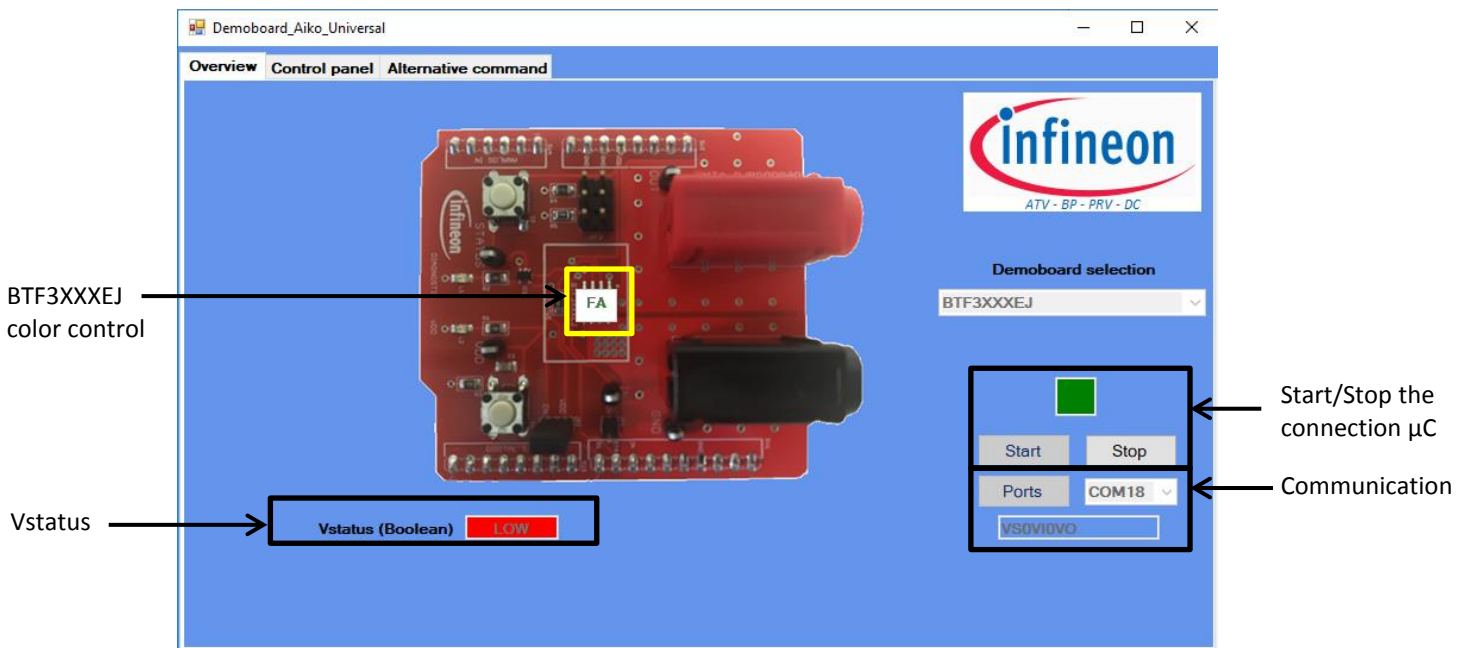

- BTF3xxxEJ color control has three possible states: ON OFF FA. FA indicates STATUS is latched.
- If BTF3xxxEJ operates normally, Vstatus should appear in green.
- If BTF3xxxEJ is latched, Vstatus appears in red. Status needs to be reset by pressing S2 or via Alternative command page.

3.2.2 Control Panel

- Buttons ON and OFF allow user to switch ON and OFF BTF3xxxEJ in continuous mode.

- Button “Pulse” creates a manageable pulse on BTF3xxxEJ.
 - User can create a pulse with period control
 - Ending Action defines if the device is left ON or OFF after the pulses.
 - Duration of ON pulse is adjusted with “Positive width” value
 - Duration of OFF pulse is adjusted with “Negative width” value
- Button PWM allows user to manage dutycyle and frequency.

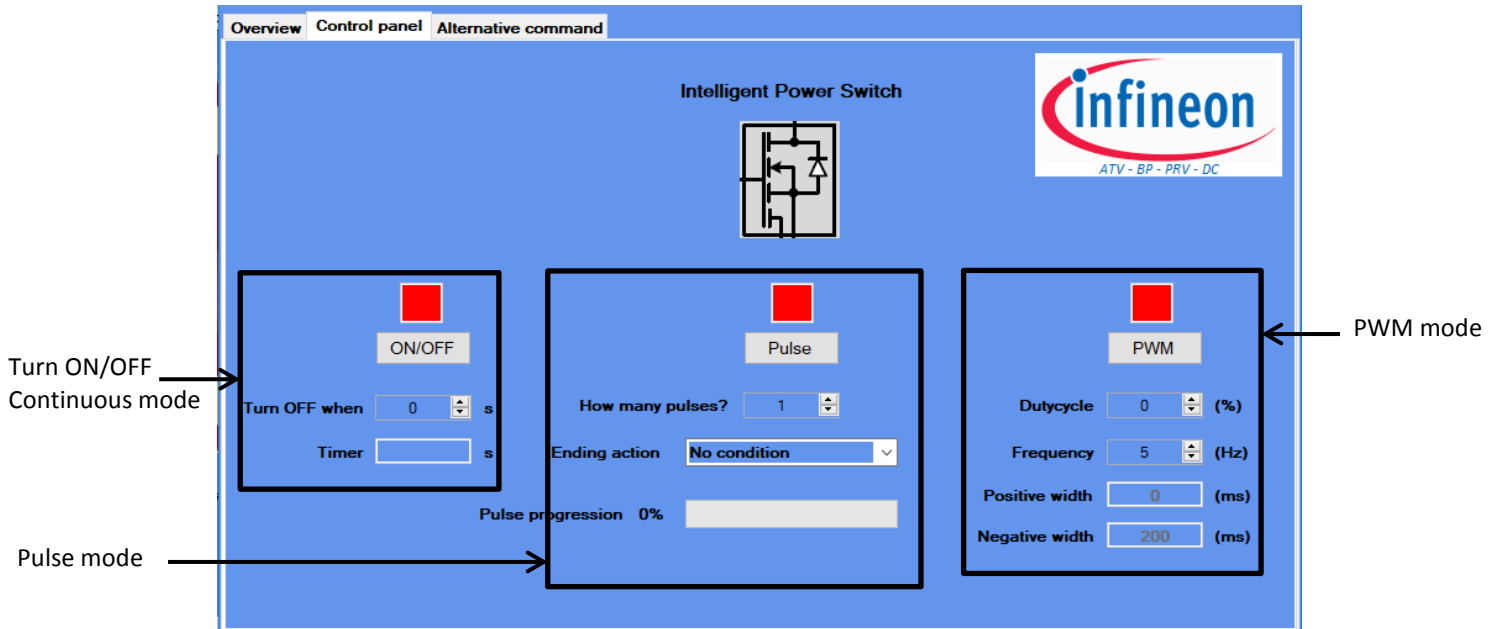

3.2.3 Alternative Command

- Button Reset Status reset the Status and the function I_lim trigger
- Button Reset Trigger reset the function I_lim trigger only
- Button ENABLE switches ON or OFF the enable pin.

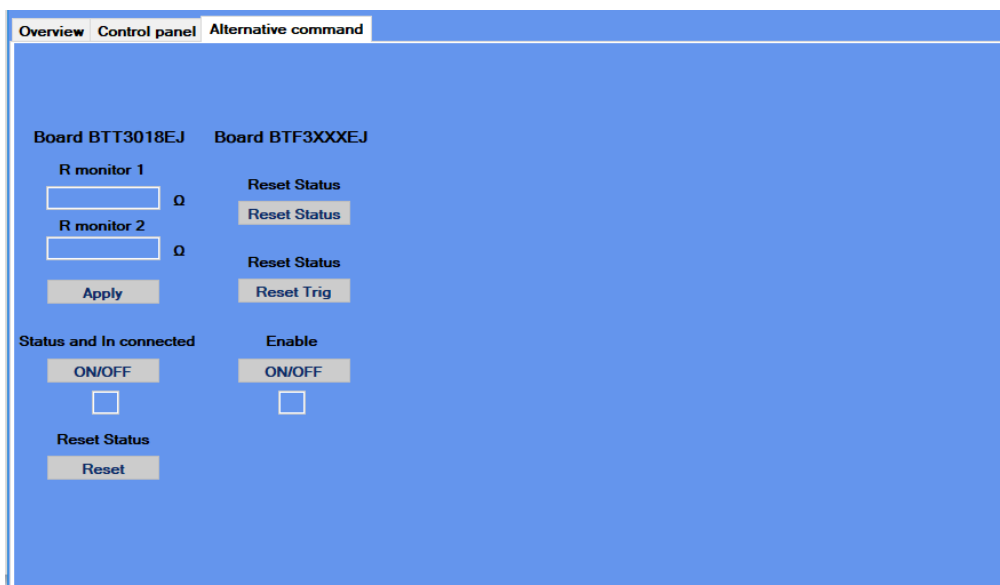

4 Board connectors description

4.1 Power connectors

Name	Connector	Type	Description
JOUT	P1	Power supply	OUT
JGND	P2	Ground power	Ground

4.2 ARDUINO/XMC1100 connectors

4.2.1 Connector SV1

Name	Pin	Type	Description
	1	No connected	
	2	No connected	
	3	No connected	
Gnd	4	Digital Ground	Ground
	5	No connected	
	6	No connected	
ENABLE	7	Digital Input	To enable/disable the device
IN	8	Digital Input	To turn the device ON/OFF
STATUS	9	Digital Input	To monitor the part status
S1	10	Not connected	S1 Button (programmable by user)

4.2.2 Connector SV2

Name	Pin	Type	Description
-	1	No connected	
-	2	No connected	
-	3	No connected	
-	4	No connected	
Vdd	5	Supply	Vdd
Gnd	6	Digital Ground	Ground
Gnd	7	Digital Ground	Ground
-	8	No connected	

4.2.3 Connector SV3

Name	Pin	Type	Description
-	1	No connected	-
-	2	No connected	-
-	3	No connected	-
-	4	No connected	-
-	5	No connected	-
-	6	No connected	-
-	7	No connected	-
-	8	No connected	-

4.2.4 Connector SV4

Name	Pin	Type	Description
	1	No connected	
	2	No connected	
	3	No connected	
	4	No connected	
	5	No connected	
	6	No connected	

4.3 Test points

Name	Pin	Type	Description
IN	1	Digital Input	Pin activation for BTF3xxxEJ
VDD	2	Logic SUPPLY	Pin to provide supply to BTF3xxxEJ Logic
STATUS	3	Digital Input	Pin to monitor the part status
OUT	4	Analog Input	Pin to monitor Vout
GND	5	Analog input	Pin to monitor GND

6 B.O.M.

<u>Part</u>	<u>Value</u>	<u>Package</u>	<u>Description</u>	<u>Qty</u>	<u>Distributor</u>	<u>Reference</u>
HITFET+ TDSO-8		DSO8	HITFET+ Low side Switch	1		
S1, S2		B3F-10XX	Switch	1	Farnell	176432
JP1	1pin	2.54mm	Jumper	1	Farnell	2356152
JP2	2 pin	2.54mm	Jumper	1	Farnell	1022245
JP3	6pins	2.54mm	Jumper	1	Farnell	1022231
ENABLE	GREEN	CHIP-LED0805	LED	1	Farnell	2099235
FAILURE	RED	CHIP-LED0805	LED	1	Farnell	2099241
R1, R2, R3	1k50hm	805	Resistor	3	Farnell	9333924
GNDCONNECTOR	Black		Banana Connector	1	Farnell	1698983
OUTCONNECTOR	Red		Banana Connector	1	Farnell	1698982
RSTATUS	4k70hm		Resistor	1	Farnell	2447672
IC1		SOT353-1	Inverter	1	Farnell	2445092
5V, GND, IN, OUT, STATUS		TPSPAD1-13	Test point	5	Farnell	8731195
SV1	10 pins	2.54mm	pin header	1	Farnell	1841229
SV2	6 pins	2.54mm	pin header	1	Farnell	2356158
SV3, SV4	8 pins	2.54mm	pin header	2	Farnell	2356160
R4	5k80hm	805	Resistor	1	Farnell	2613855
R5	58k0hm	805	Resistor	1	Farnell	2303730
C1	100nF	C0805	Capacitor	1	Farnell	2496944

7 Board Layout

7.1 TOP

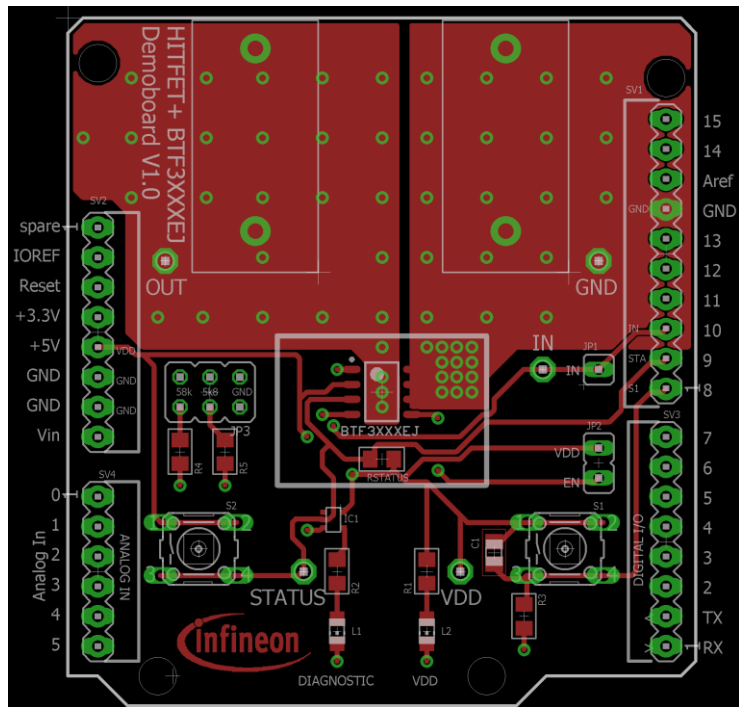

7.2 BOTTOM

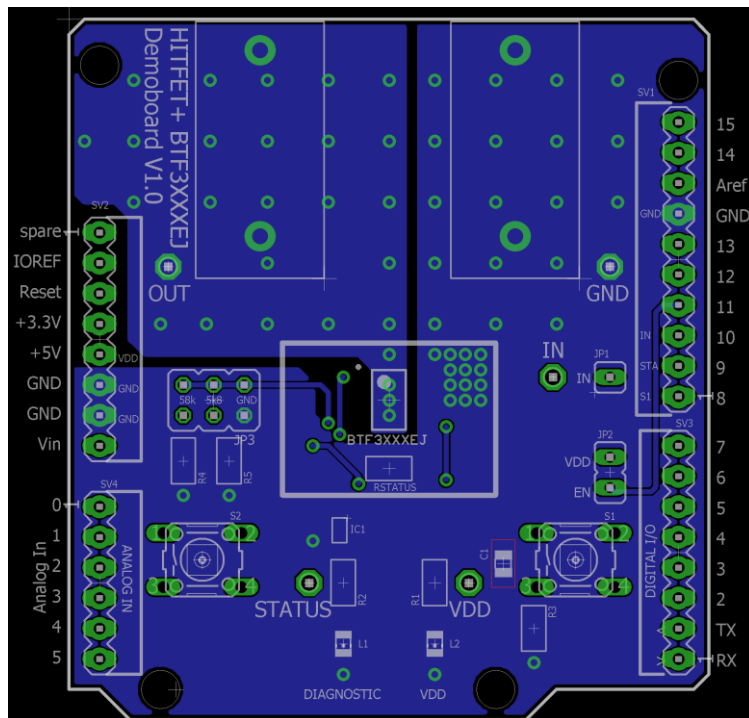

7.3 MECHANICAL VIEW

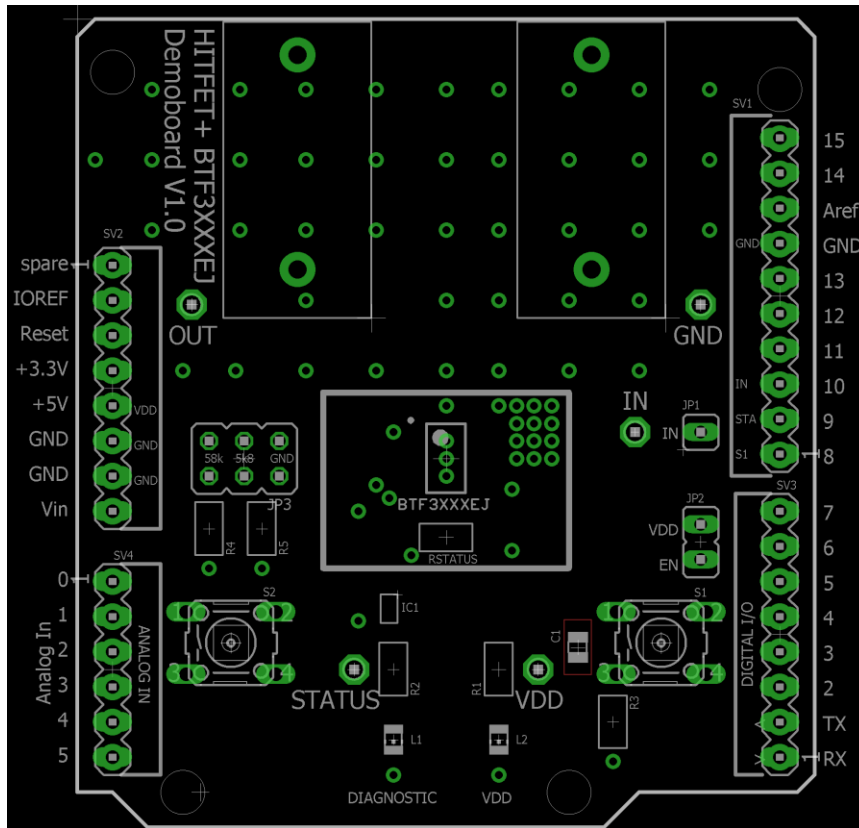

Revision History: V1.0

Previous Version: none		
Revision	Date	Changes
1.0	November 22 nd 2017	First release

