

Introduction

The MicroClock development kit is designed to support the 5x2503 family of MicroClock devices. It provides a convenient way of verifying, configuring and programming the blank parts for all MicroClock devices. The IDT [Timing Commander™](#) GUI communicates to the devices for configuration and frequency validation on the USB mother board via an on-board USB interface. Using additional socket daughter boards, a validated configuration is used to program blank parts for any of the MicroClock devices.

Table 1. MicroClock Family Products

Product	Description	Package
5X2503	1.8V integrated with an internal 26M crystal.	12-DFN
5L2503	1.8V using an external 26M crystal.	12-DFN

For details of product operation, refer to the product datasheet.

Socket Daughter Board Overview

The MicroClock socket daughter board is ready with all of the necessary components and connections to test the functionality of the configuration. A blank device is placed in the socket for programming (see [Figure 1](#)).

Figure 1. Socket Daughter Board Overview (socket closed)

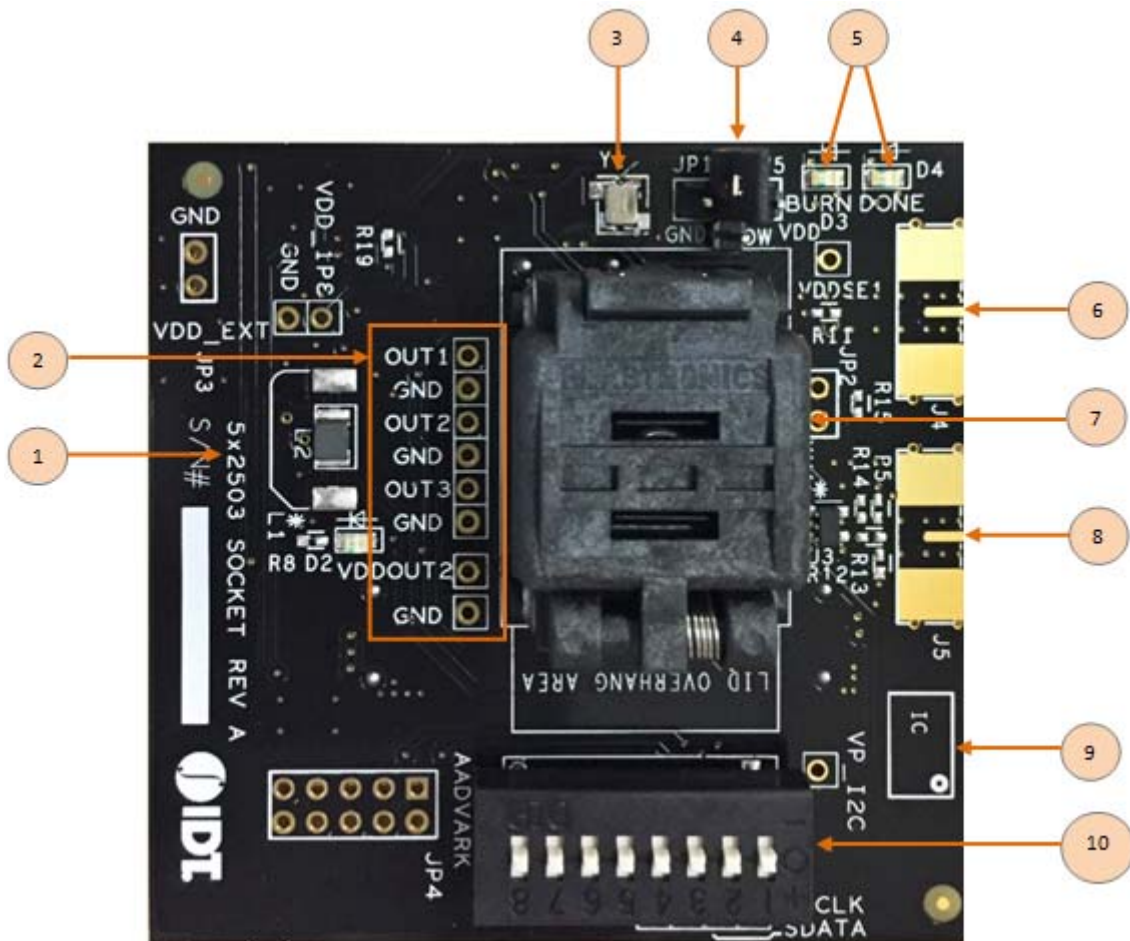
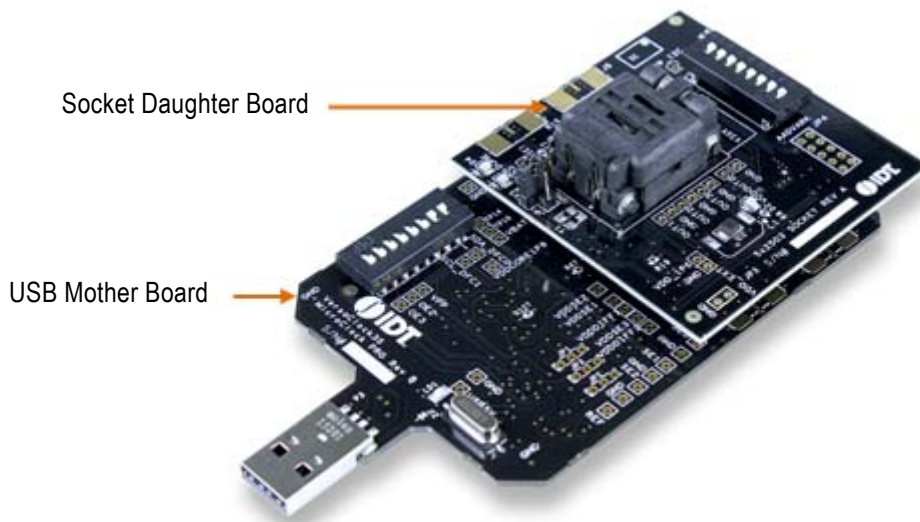


Table 2. Socket Daughter Board Descriptions

Label Number	Label Name	Description
1	Device ID	Define the evaluation board supports for 5X2503 or 5L2503.
2	Probing Notes	These are test points for single-ended outputs; SE1, SE2, SE3 and Reference with GND test points in between.
3	26MHz Crystal	Crystal with 8pF load is populated for 5L2503. For 5X2503; the crystal is not populated.
4	Jumper	A switch jumper to control OE1 function. The default setting is set for OTP burn
5	LEDs	Two LED lights to indicate the OTP burn process.
6	SMA connector for OUT1	Additional frequency test connector using SMA for OUT1.
7	Socket	12-pin DFN socket for placing MicroClock blank parts.
8	SMA Connector for PPS Mode on OUT1	SMA connector for PPS mode validation.
9	Part Indication	Indication for device orientation.
10	DIP Switch	Used to configure the device in different modes (software mode as default for I ² C control; hardware mode as output pin control selection).

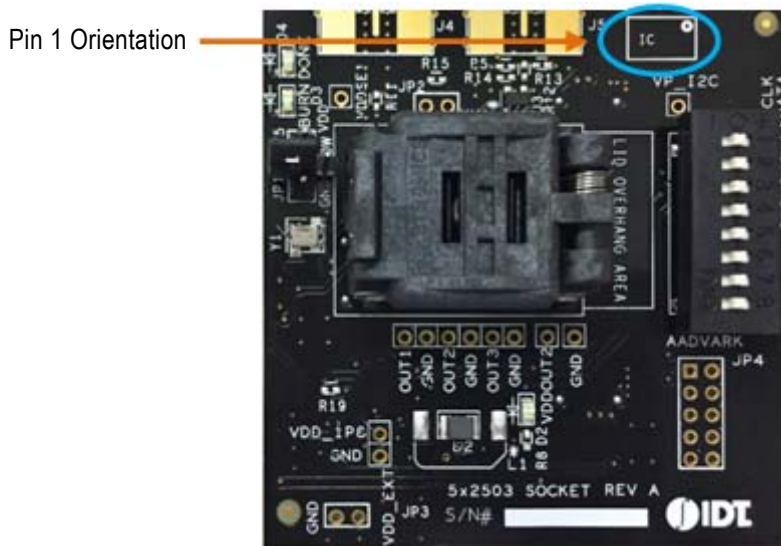
Figure 2. Development Kit Boards
(Evaluation socket daughter board combined with a USB mother board)



The socket daughter board for 5x2503, combined with a USB mother board, is used for the purpose of validation and measurement on all outputs. After a configuration is validated on the USB mother board, the board can be connected along with the specific socket daughter board for programming on blank parts of MicroClock family devices. Note that blank parts can only be burnt once through the socket daughter board. The socket daughter board is bundled with a USB mother board. The following description and images are restricted to the socket daughter board.

On the footprint of the socket daughter board, a pin orientation identifies the position of Pin 1 as shown in [Figure 3](#). Align the dot of the blank part in the socket as pointed. After placing the blank part, secure the socket cover.

Figure 3. Socket Daughter Board (pin position)



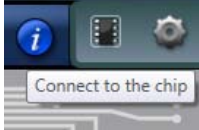

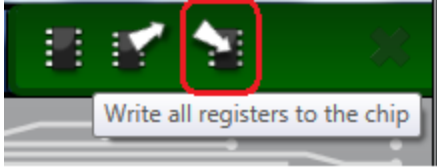
Programming Steps

Use programming steps 2 – 7 as described in the [Table 3](#) to program a configuration into the blank part in the specified socket daughter board.

Table 3. Programming Steps

Step Number	Step Description	Comments
0	A configuration has been validated and completed on the development kit.	Configurations should have been validated on the USB mother board and are ready to proceed for programming on blank parts.
1	All intended outputs should be available for measurement on the USB development kit.	Upon validation of the outputs, “Disconnect” the USB board and proceed for OTP burn as explained in the following sections.
2	Plug the specified socket daughter board onto the USB mother board (shown in Figure 2).	USB mother board with the socket daughter board provides a communication channel between the GUI and a blank part in the socket daughter board.
3	Start Timing Commander software (this step can be skipped if a configuration is ready in the personality).	Launch the Timing Commander GUI software. Load the personality file.

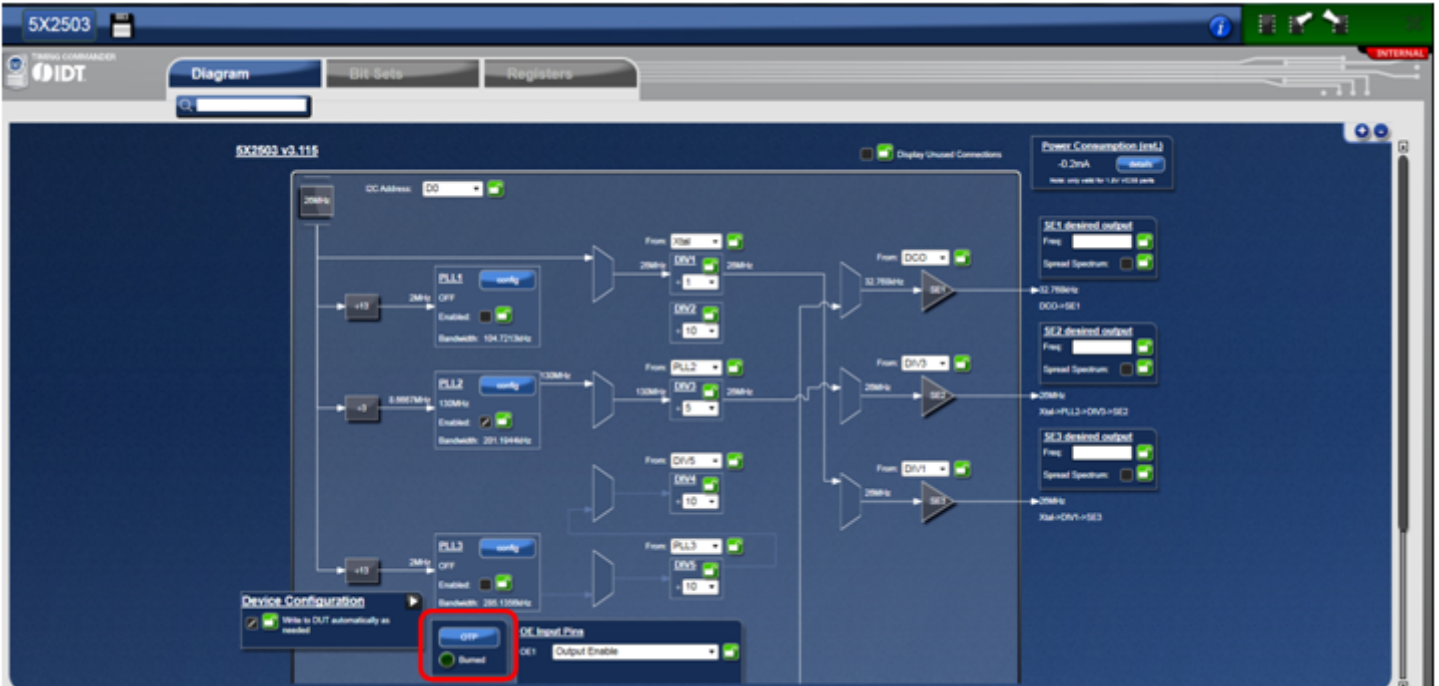
Table 3. Programming Steps (Cont.)

Step Number	Step Description	Comments
4	New settings file (this step can be skipped if a configuration is ready in the personality).	Using the Timing Commander GUI, start a new settings file or open a pre-optimized file.
5	Connect to the development kit.	Click on the chip symbol on the top right corner of the GUI window. 
6	—	Once connected, new options will be available on a green background indicating that the USB mother board has successfully connected with the socket daughter board. 
7	Click the “write all” icon.	The configuration will be programmed into the blank part in the socket. 

Use the following steps to proceed with the OTP burn.

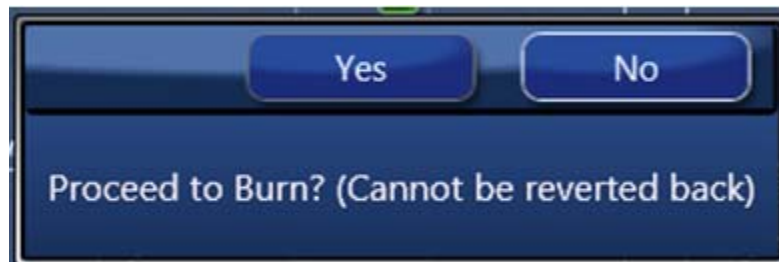
- After the chip is connected to the Timing Commander, the main window of configuration is shown (see Figure 4). Click the OTP icon on the left side of personality window.

Figure 4. Personality Main Window



- After clicking the icon, a new dialogue window will open up (see Figure 5). Click “Yes” to proceed with the OTP burn process. Please note that this process cannot be reverted back.

Figure 5. Proceed to Burn Dialog Window

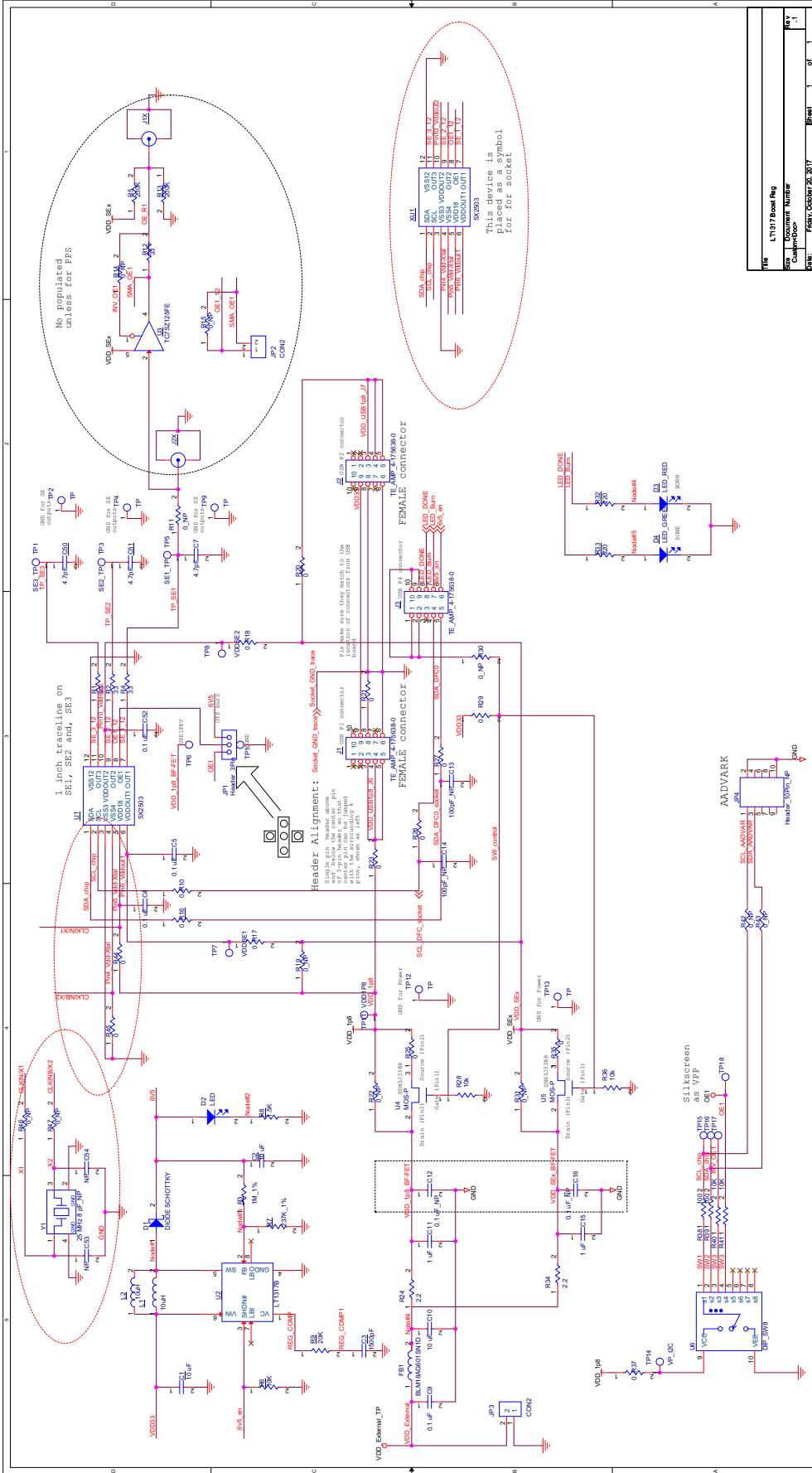


- If the OTP burn process is successful, a dialog window with “Success” will appear indicating that the process is completed and the part has been burnt based on the configuration.

Figure 6. Success Dialog Window

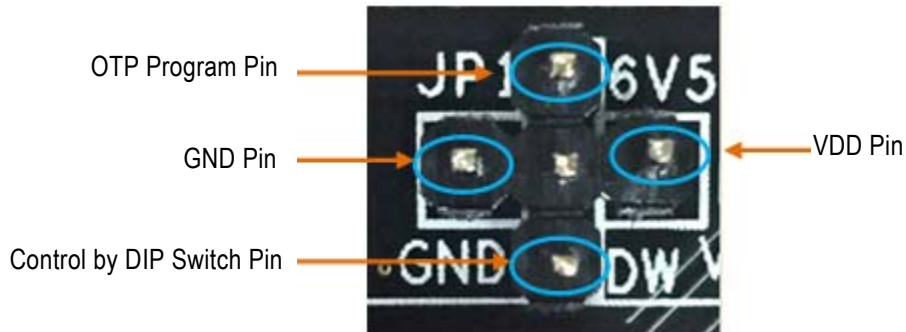


Figure 7. Development Kit Board Schematic 1



OE1 pin on MicroClock socket daughter board provides multiple functions. To program OTP, please ensure to set the jumper (JP1) on OTP program pin (default setting). See [Figure 8](#).

Figure 8. Jumper Setup



Termination Options

Table 4. Termination Options for Single-ended Output -1

Signal Type	Series Resistor, R4
LVC MOS	33Ω

Table 5. Termination Options for Single-ended Output -2

Signal Type	Series Resistor, R2
LVC MOS	33Ω

Table 6. Termination Options for Single-ended Output -3

Signal Type	Series Resistor, R1
LVC MOS	33Ω

Figure 9. 5X2503 Socket Daughter Board (board without crystal)

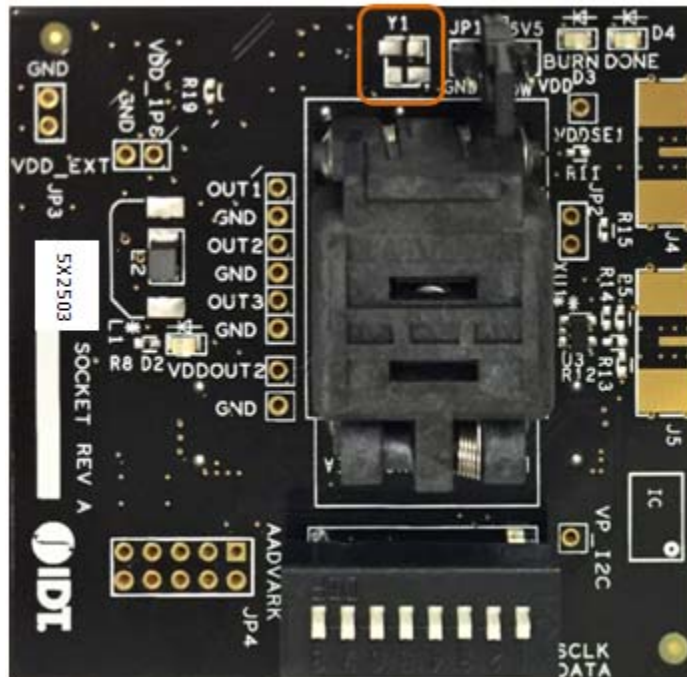
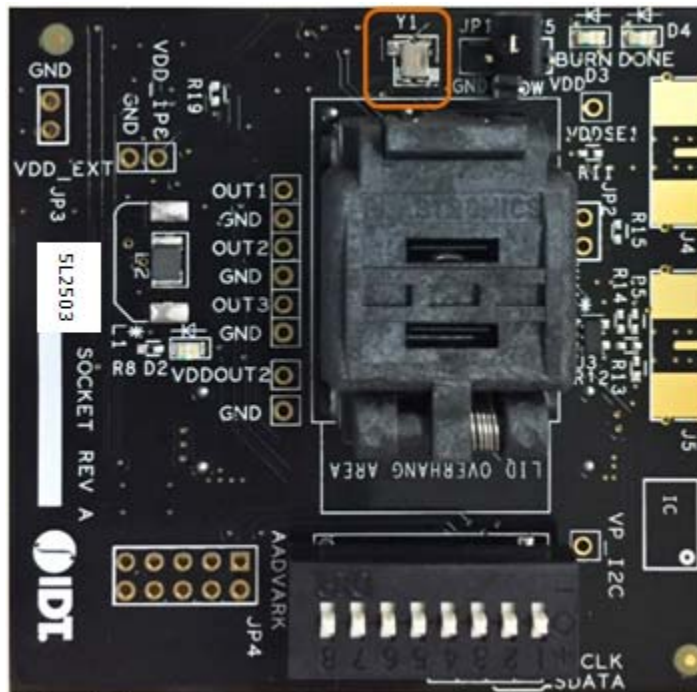


Figure 10. 5L2503 Socket Daughter Board (board populated with a 26MHz crystal)



Revision History

Revision Date	Description of Change
October 20, 2017	Initial release.