

Dec.1.2023 Copyright 2023 HIROSE ELECTRIC CO., LTD. All Rights Reserved.
In case of consideration for using Automotive equipment / device which demand high reliability, kindly contact our sales window correspondents.

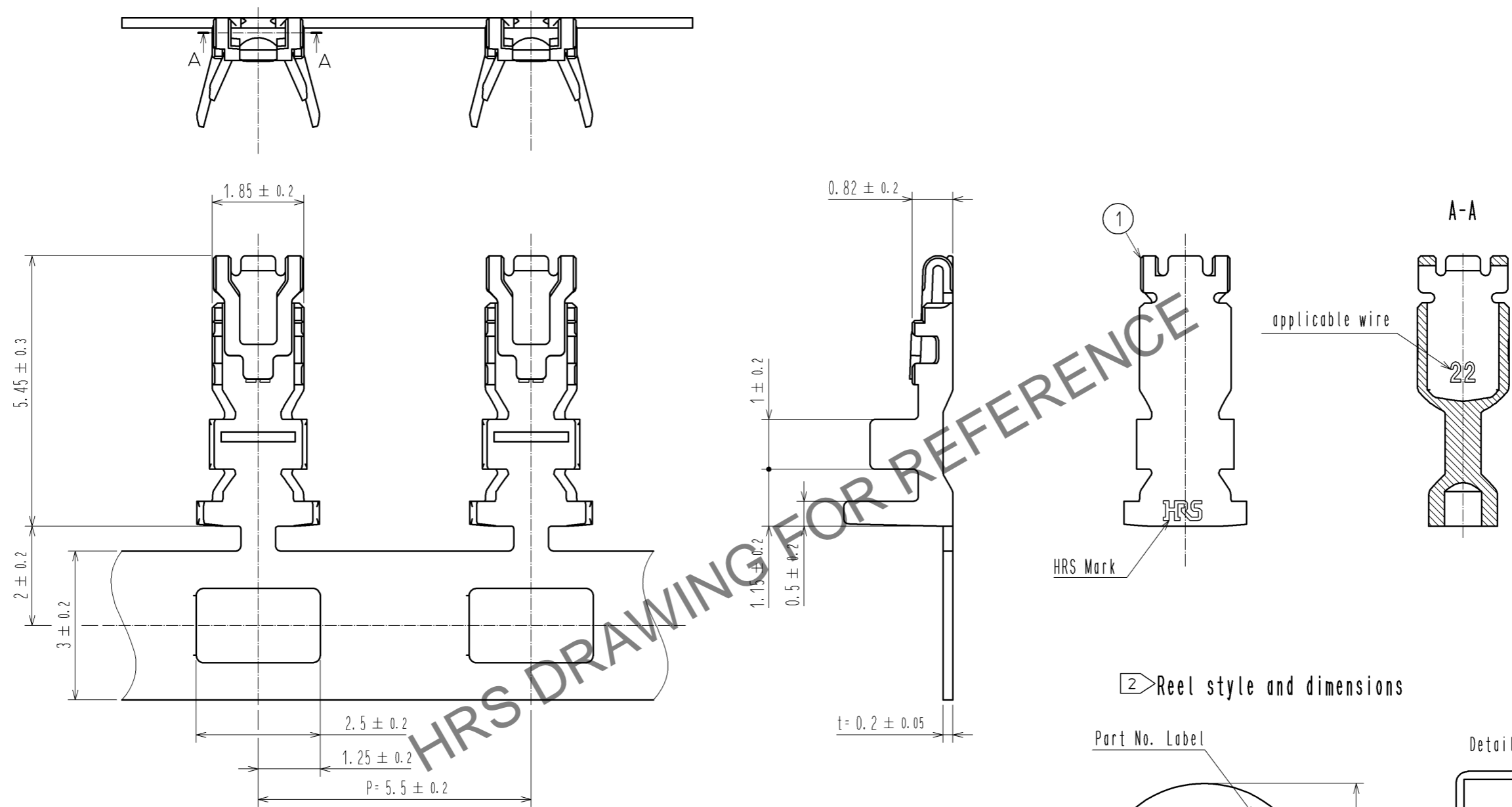

2 Reel style and dimensions

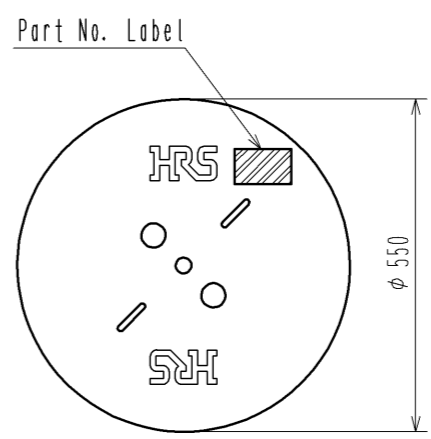

Detail Of Part No. Label

HRS		検査
品名コード	CL667-0042-8	
品名	DF59M-2224PCF	
数量	15000	
仕様		
LOT No.		
継ぎ目		
Section		Inspection
Lot No.		
Specification		
Quantity		
Part No.		
Code No.		

- Notes
- 1RL : 15000 contacts.
 - 2 Style of reel and box are shown in figure.
 3. Please be sure to check the form of crimping using a cable when you adjust applicator.
 4. Always refer to the manuals below for operation of this product.
For Cable assembly / Cable assembly procedure ETAD-H0778
For Mating/Unmating / Operation manual ETAD-H0779

NO.	MATERIAL	FINISH . REMARKS	NO.	MATERIAL	FINISH . REMARKS		
			1	Copper Alloy	Surface :Tin plating 1μm MIN		
UNITS mm		SCALE 10 : 1	COUNT	DESCRIPTION OF REVISIONS	DESIGNED	CHECKED	DATE
HRS	HIROSE ELECTRIC CO., LTD.	APPROVED : HK. UMEHARA	14. 05. 20	DRAWING NO.	EDC3-356515-01		
		CHECED : HK. UMEHARA	14. 05. 20	PART NO.	DF59M-2224PCF		
		DESIGNED : SZ. ONO	14. 05. 19	CODE NO.	CL667-0042-8-00		
		DRAWN : SZ. ONO	14. 05. 19		1/1		