

Description

The DGD2388M is a three-phase gate driver IC designed for high-voltage / high-speed applications, driving N-Channel MOSFETs and IGBTs in a half-bridge configuration. High-voltage processing techniques enable the DGD2388M's high-side to switch to 600V in a bootstrap operation.

The DGD2388M logic inputs are compatible with standard TTL and CMOS levels (down to 3.3V) for easy interfacing with controlling devices and are enabled low to better function in high noise environments. The driver outputs feature high-pulse current buffers designed for minimum driver cross conduction.

The DGD2388M offers numerous protection functions. A shoot-through protection logic prevents both outputs from being high when both inputs are high (fault state), an undervoltage lockout for VCC shuts down all drivers through an internal fault control, and a UVLO for VBS shuts down the respective high-side output.

The DGD2388M is offered in SO-20 package and the operating temperature extends from -40°C to +125°C.

Applications

- 3-Phase Motor Inverter Driver
- White Goods – Air Conditioner, Washing Machine, Refrigerator
- Industrial Motor Inverter – Power Tools, Robotics
- General Purpose 3-Phase Inverter

Features

- Three Floating High-Side Drivers in Bootstrap Operation to 600V
- 420mA Source / 750mA Sink Output Current Capability
- Logic Input 3.3V Capability
- Internal Deadtime of 315ns to Protect MOSFETs and IGBTs
- Matched Prop Delay time maximum of 50ns
- Outputs In Phase with Inputs
- Schmitt Triggered Logic Inputs
- Cross Conduction Prevention Logic
- Undervoltage Lockout for All Channels
- Extended Temperature Range: -40°C to +125°C
- **Totally Lead-Free & Fully RoHS Compliant (Notes 1 & 2)**
- **Halogen and Antimony Free. "Green" Device (Note 3)**
- **For automotive applications requiring specific change control (i.e. parts qualified to AEC-Q101, PPAP capable, and manufactured in IATF 16949 certified facilities), please [contact us](https://www.diodes.com/quality/product-definitions/) or your local Diodes representative.**

Mechanical Data

- Case: SO-20 (Type TH)
- Case Material: Molded Plastic. "Green" Molding Compound. UL Flammability Classification Rating 94V-0
- Moisture Sensitivity: Level 3 per J-STD-020
- Terminals: Finish – Matte Tin Plated Leads, Solderable per MIL-STD-202, Method 208 (E3)
- Weight: 0.250 grams (Approximate)

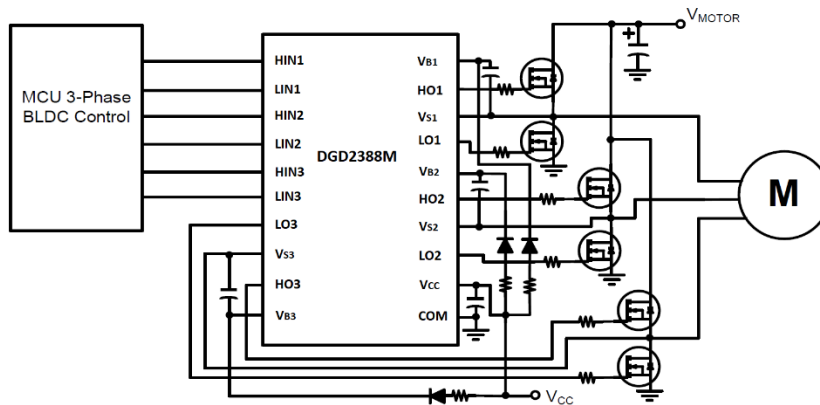

Typical Configuration



SO-20

Top View

Ordering Information (Note 4)

Part Number	Marking	Reel Size (inches)	Tape Width (mm)	Quantity per Reel
DGD2388MS20-13	DGD2388	13	24	1,500

- Notes:
1. No purposely added lead. Fully EU Directive 2002/95/EC (RoHS), 2011/65/EU (RoHS 2) & 2015/863/EU (RoHS 3) compliant.
 2. See <https://www.diodes.com/quality/lead-free/> for more information about Diodes Incorporated's definitions of Halogen- and Antimony-free, "Green" and Lead-free.
 3. Halogen- and Antimony-free "Green" products are defined as those which contain <900ppm bromine, <900ppm chlorine (<1500ppm total Br + Cl) and <1000ppm antimony compounds.
 4. For packaging details, go to our website at <https://www.diodes.com/design/support/packaging/diodes-packaging/>.

Marking Information



Dii = Manufacturer's Marking
 DGD2388 = Product Type Marking Code
 YY = Year (ex: 21 = 2021)
 WW = Week (01 to 53)

Pin Diagrams

Top View

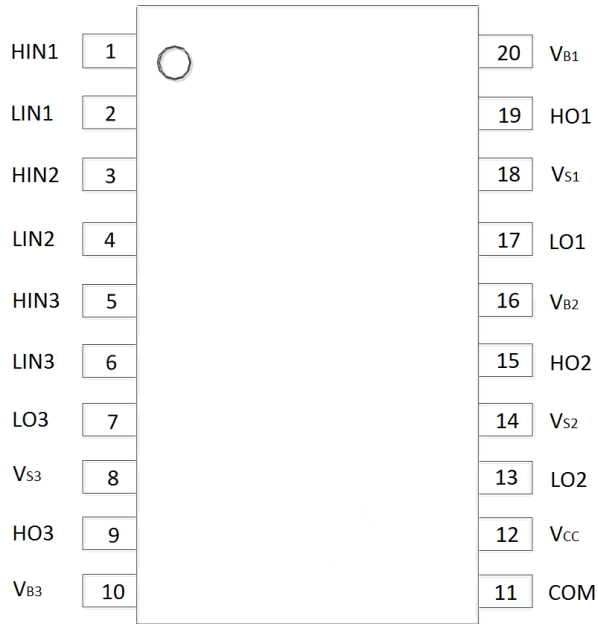

SO-20

Pin Descriptions

Pin Number	Pin Name	Function
1, 3, 5	HIN1, HIN2, HIN3	Logic Input for High-Side Gate Driver Output, In Phase with HO
2, 4, 6	LIN1, LIN2, LIN3	Logic Input for Low-Side Gate Driver Output, In Phase with LO
7, 13, 17	LO3, LO2, LO1	Low-Side Gate Driver Output
8, 14, 18	V _{S3} , V _{S2} , V _{S1}	High-Side Floating Supply Return
9, 15, 19	HO3, HO2, HO1	High-Side Gate Driver Output
10, 16, 20	V _{B3} , V _{B2} , V _{B1}	High-Side Floating Supply
11	COM	Low-Side Driver and Logic Return
12	V _{CC}	Low-Side and Logic Fixed Supply

Functional Block Diagram

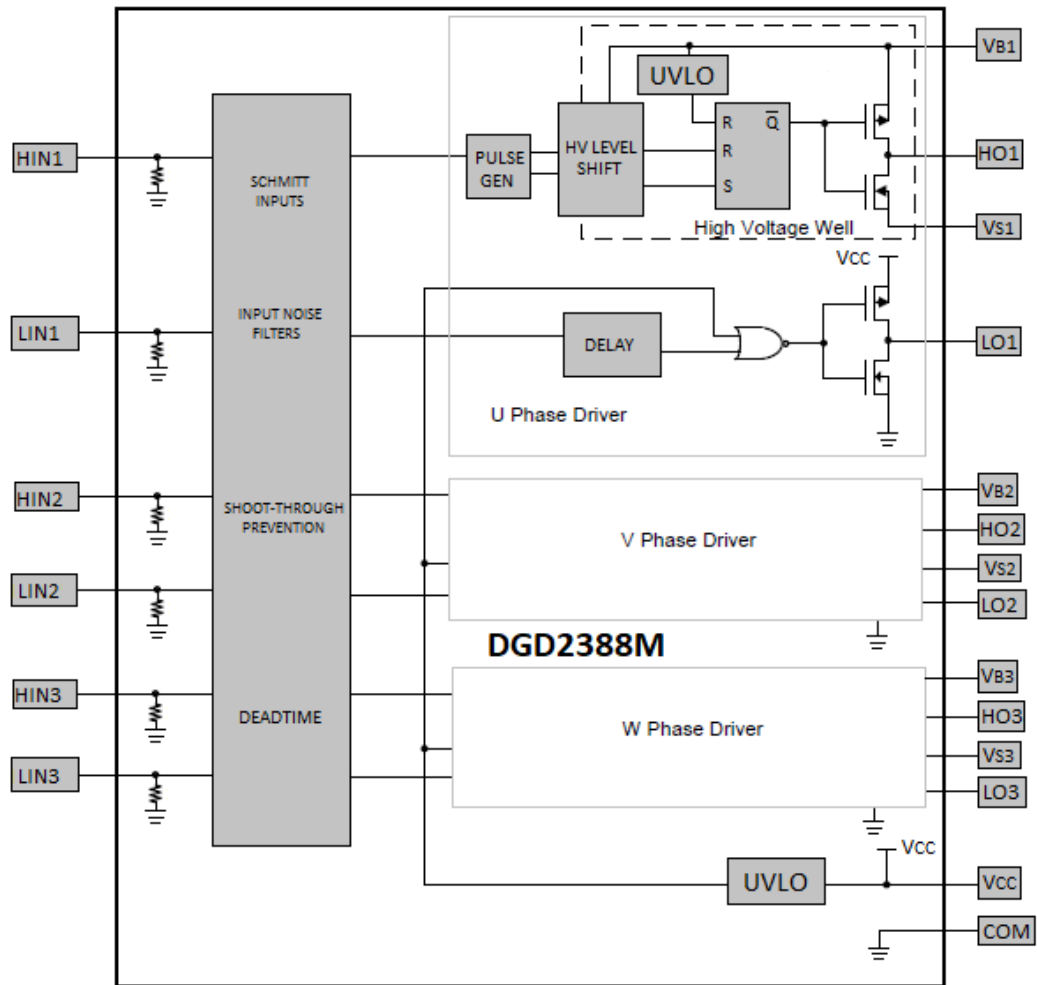

Absolute Maximum Ratings (@T_A = +25°C, unless otherwise specified.)

Characteristic	Symbol	Value	Unit
High-Side Floating Supply Voltage	V _B	-0.3 to +624	V
High-Side Floating Supply Offset Voltage	V _S	V _B -24 to V _B +0.3	V
High-Side Floating Output Voltage	V _{HO}	V _S -0.3 to V _B +0.3	V
Low-Side Output Voltage	V _{LO}	-0.3 to V _{CC} +0.3	V
Offset Supply Voltage Transient	dV _S / dt	50	V/ns
Low-Side Fixed Supply Voltage	V _{CC}	-0.3 to +24	V
Logic Input Voltage (HIN and LIN)	V _{IN}	-0.3 to +5.5	V

Thermal Characteristics (@T_A = +25°C, unless otherwise specified.)

Characteristic	Symbol	Value	Unit
Power Dissipation Linear Derating Factor (Note 5)	P _D	1.88	W
Thermal Resistance, Junction to Ambient (Note 5)	R _{θJA}	66.6	°C/W
Operating Temperature	T _J	+150	°C
Lead Temperature (Soldering, 10s)	T _L	+300	
Storage Temperature Range	T _{STG}	-55 to +150	

Note: 5. When mounted on a standard JEDEC 2-layer FR-4 board.

Recommended Operating Conditions

Parameter	Symbol	Min	Max	Unit
High-Side Floating Supply Absolute Voltage	V _B	V _S + 10	V _S + 20	V
High-Side Floating Supply Offset Voltage	V _S	(Note 6)	600	V
High-Side Floating Output Voltage	V _{HO}	V _S	V _B	V
Low-Side Fixed Supply Voltage	V _{CC}	10	20	V
Low-Side Output Voltage	V _{LO}	COM	V _{CC}	V
Logic Input Voltage (HIN and LIN)	V _{IN}	0	5	V
Ambient Temperature	T _A	-40	+125	°C

Note: 6. Logic operation for V_S of -5V to +600V.

DC Electrical Characteristics (V_{BIAS} (V_{CC} , V_{BS}) = 15V, @ T_A = +25°C, unless otherwise specified.) (Note 7)

Parameter	Symbol	Min	Typ	Max	Unit	Condition
Logic "0" Input Voltage (Note 8)	V_{IH}	2.4	—	—	V	—
Logic "1" Input Voltage (Note 8)	V_{IL}	—	—	0.8	V	—
High Level Output Voltage, $V_{BIAS} - V_O$	V_{OH}	—	0.2	0.5	V	$I_O = 2\text{mA}$
Low Level Output Voltage, V_O	V_{OL}	—	0.07	0.2	V	$I_O = 2\text{mA}$
Offset Supply Leakage Current	I_{LK}	—	—	10	μA	$V_B = V_S = 600\text{V}$
Quiescent V_{BS} Supply Current	I_{BSQ}	—	50	80	μA	$V_{IN} = 0\text{V}$ or 5V
Operating V_{BS} Supply Current	I_{BSO}	—	400	—	μA	$f_s = 20\text{kHz}$
Quiescent V_{CC} Supply Current	I_{CCQ}	—	230	330	μA	$V_{IN} = 0\text{V}$ or 5V
Operating V_{CC} Supply Current	I_{CCO}	—	500	—	μA	$f_s = 20\text{kHz}$
Logic "1" Input Bias Current	I_{IN+}	—	25	80	μA	$V_{IN} = 5\text{V}$
Logic "0" Input Bias Current	I_{IN-}	—	—	2.0	μA	$V_{IN} = 0\text{V}$
Input Pull-Down Resistance	R_{IN}	—	200	—	$\text{k}\Omega$	—
V_{BS} Supply Undervoltage Positive Going Threshold	V_{BSUV+}	7.1	8.5	9.9	V	—
V_{BS} Supply Undervoltage Negative Going Threshold	V_{BSUV-}	6.7	8.1	9.5	V	—
V_{CC} Supply Undervoltage Positive Going Threshold	V_{CCUV+}	7.1	8.5	9.9	V	—
V_{CC} Supply Undervoltage Negative Going Threshold	V_{CCUV-}	6.7	8.1	9.5	V	—
Output High Short Circuit Pulsed Current	I_{O+}	270	420	—	mA	$V_O = 0\text{V}$, $PW \leq 10\mu\text{s}$
Output Low Short Circuit Pulsed Current	I_{O-}	600	750	—	mA	$V_O = 15\text{V}$, $PW \leq 10\mu\text{s}$

- Notes:
- The V_{IN} and I_{IN} parameters are referenced to V_{SS} and are applicable to all six channels (HIN1, 2, 3 and LIN1, 2, 3). The V_O and I_O parameters are applicable to the output pins (HO1, 2, 3 and LO1, 2, 3) and are referenced to COM.
 - For optimal operation, it is recommended that the input pulses (HIN1, 2, 3 and LIN1, 2, 3) should have a minimum amplitude of 2.4V with a minimum pulse width of 600ns.

AC Electrical Characteristics (V_{BIAS} (V_{CC} , V_{BS}) = 15V, $C_L = 1000\text{pF}$, @ T_A = +25°C, unless otherwise specified.)

Parameter	Symbol	Min	Typ	Max	Unit	Condition
Turn-On Propagation Delay	t_{ON}	70	120	170	ns	$V_S = 0\text{V}$
Turn-Off Propagation Delay	t_{OFF}	70	120	170	ns	$V_S = 0\text{V}$
Turn-On Rise Time	t_R	—	45	75	ns	$V_S = 0\text{V}$
Turn-Off Fall Time	t_F	—	25	40	ns	$V_S = 0\text{V}$
Delay Matching	t_{DM}	—	—	50	ns	—
Deadtime	t_{DT}	200	315	430	ns	—
Deadtime Matching	t_{DTM}	—	—	50	ns	—

Timing Waveforms

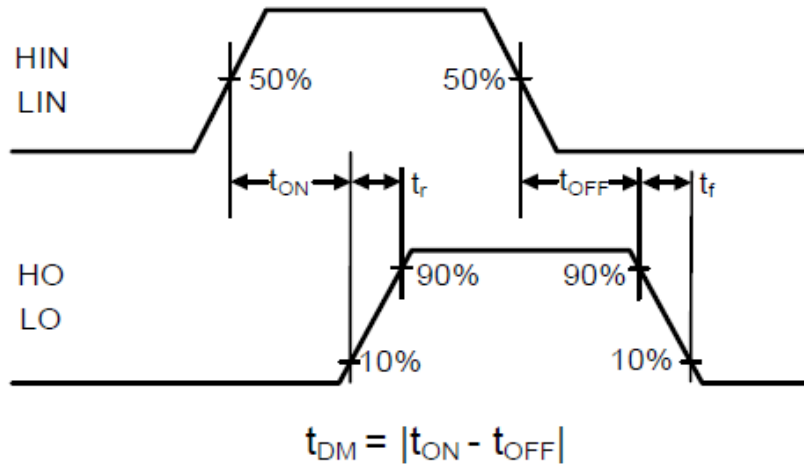

Figure 1. Switching Time Waveform Definitions

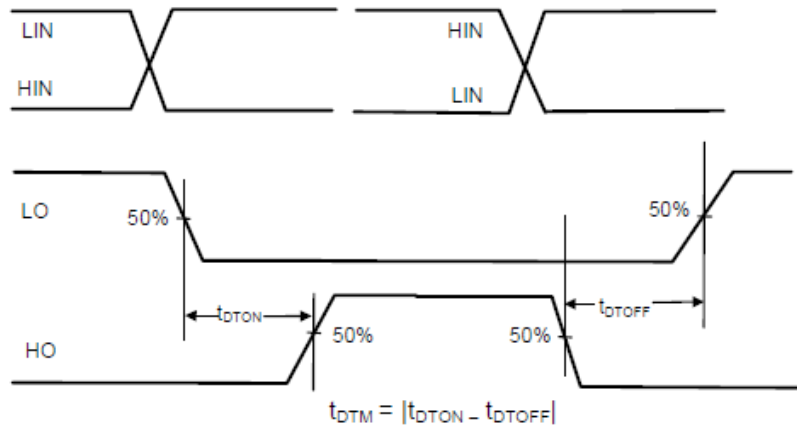

Figure 2. Deadtime Waveform Definitions

Typical Performance Characteristics (VCC = 12V, @TA = +25°C, unless otherwise specified.)

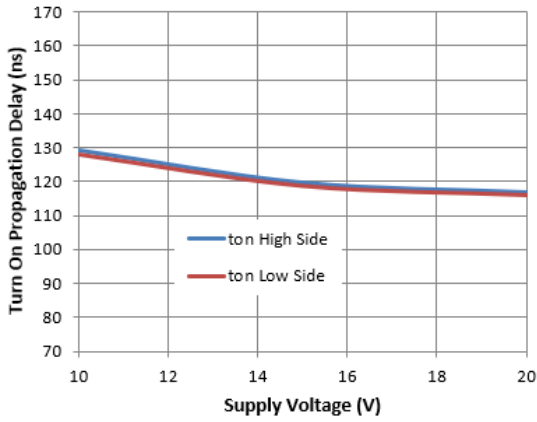

Figure 3. Turn-on Propagation Delay vs. Supply Voltage

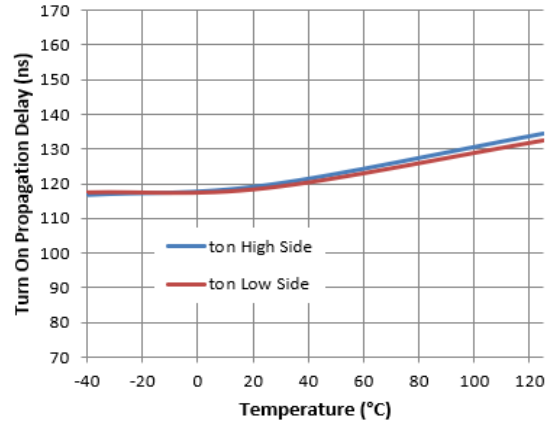

Figure 4. Turn-on Propagation Delay vs. Temperature

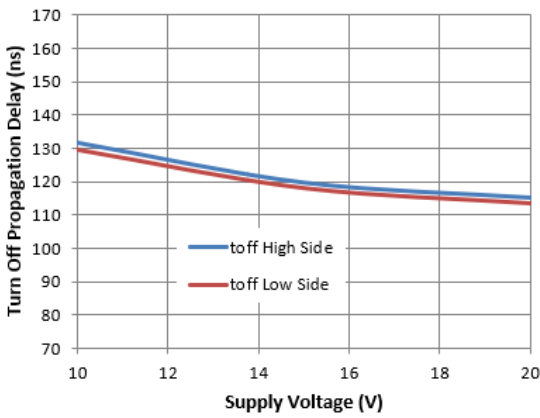

Figure 5. Turn-off Propagation Delay vs. Supply Voltage

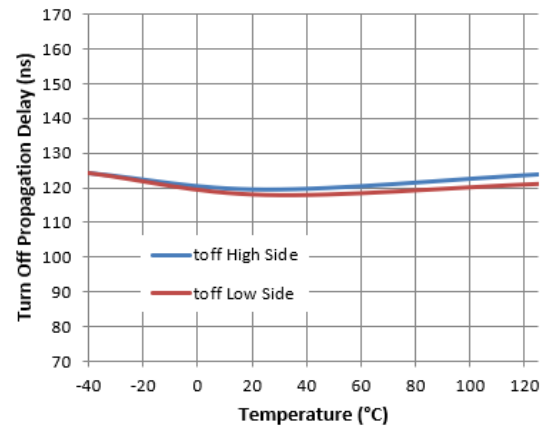

Figure 6. Turn-off Propagation Delay vs. Temperature

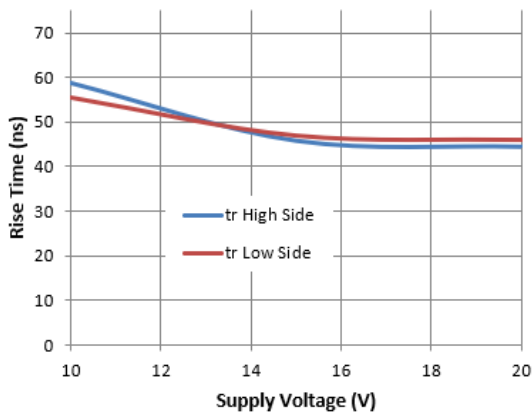

Figure 7. Rise Time vs. Supply Voltage

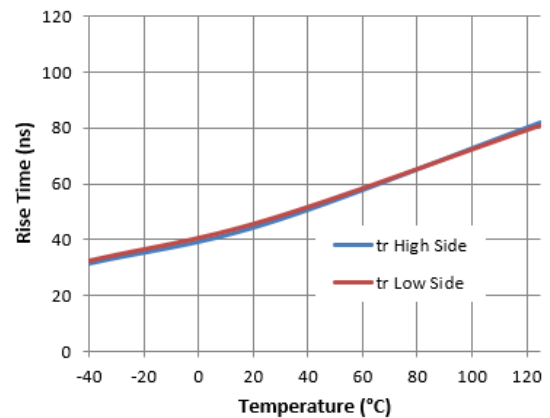

Figure 8. Rise Time vs. Temperature

Typical Performance Characteristics (Cont.)

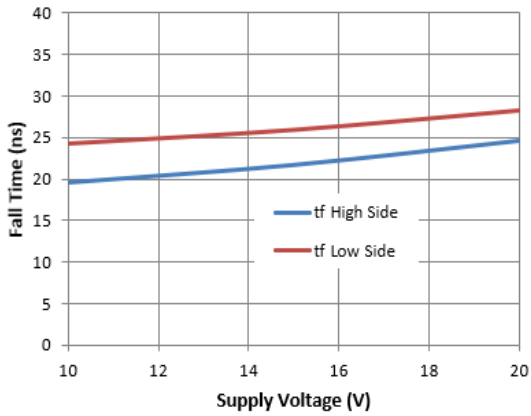

Figure 9. Fall Time vs. Supply Voltage

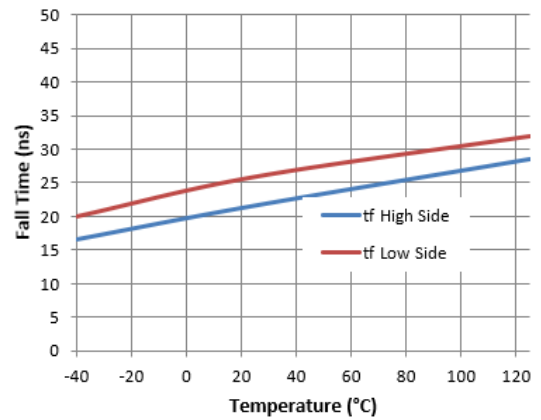

Figure 10. Fall Time vs. Temperature

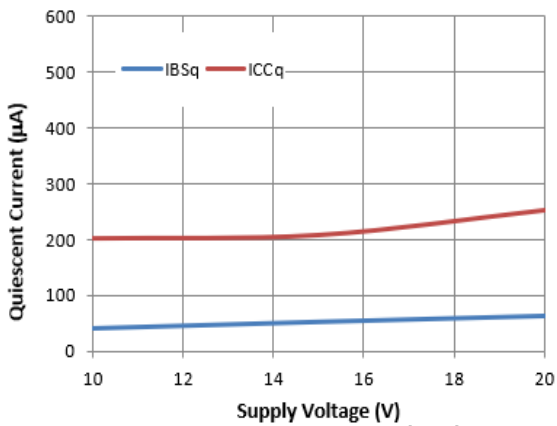

Figure 11. Quiescent Current vs. Supply Voltage

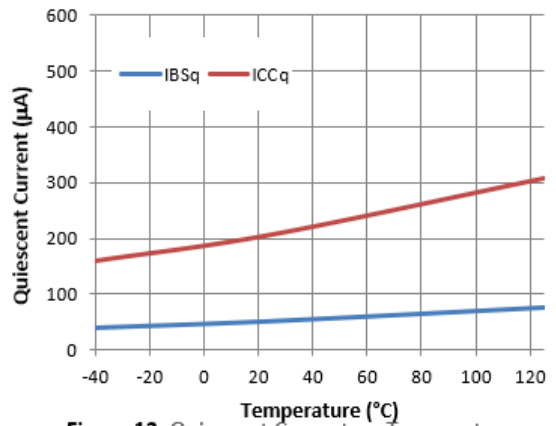

Figure 12. Quiescent Current vs. Temperature

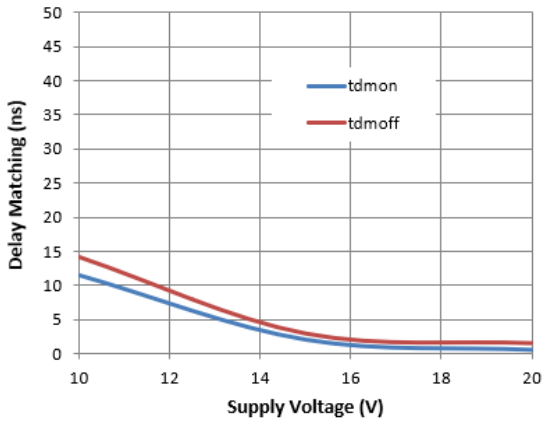

Figure 13. Delay Matching vs. Supply Voltage

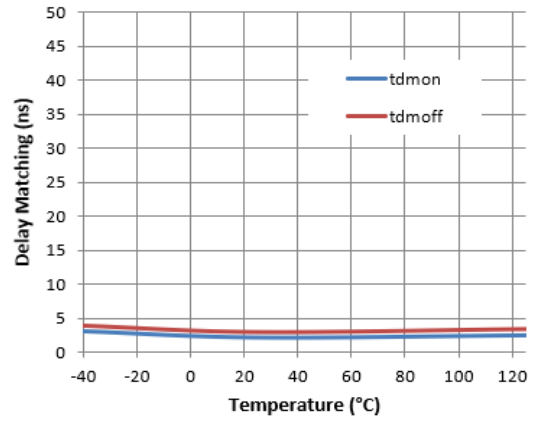

Figure 14. Delay Matching vs. Temperature

Typical Performance Characteristics (Cont.)

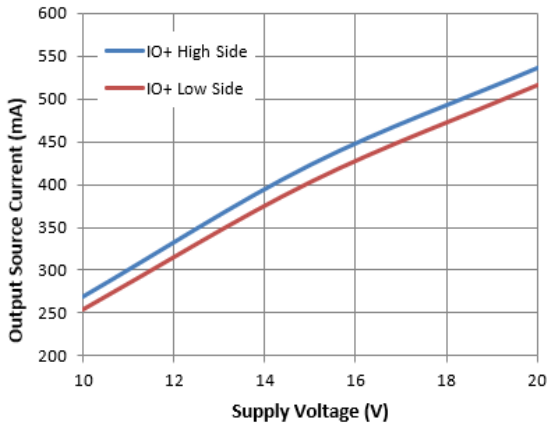

Figure 15. Output Source Current vs. Supply Voltage

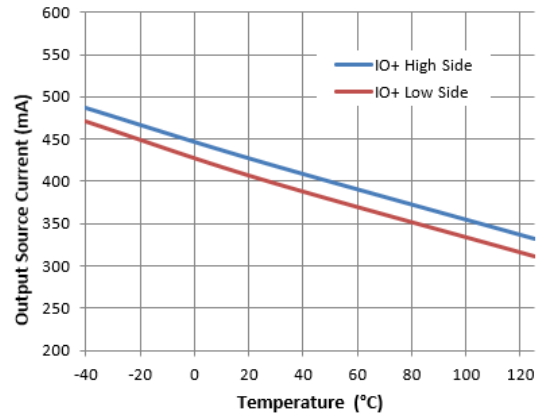

Figure 16. Output Source Current vs. Temperature

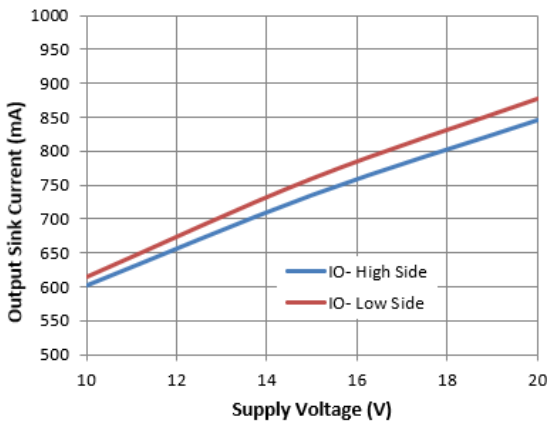

Figure 17. Output Sink Current vs. Supply Voltage

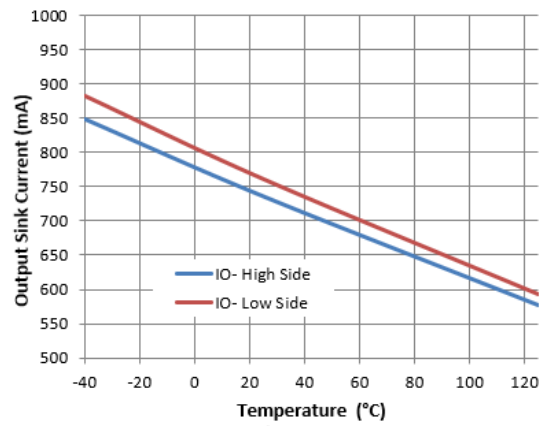

Figure 18. Output Sink Current vs. Temperature

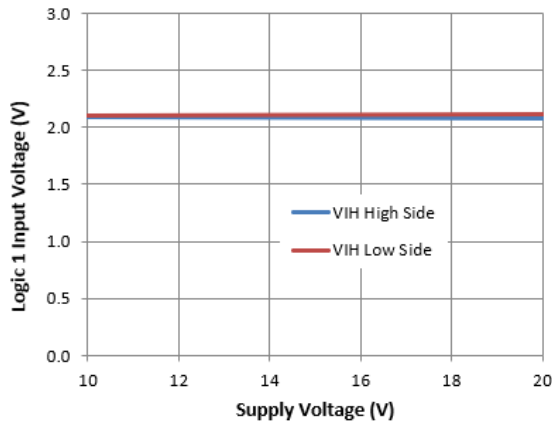

Figure 19. Logic 1 Input Voltage vs. Supply Voltage

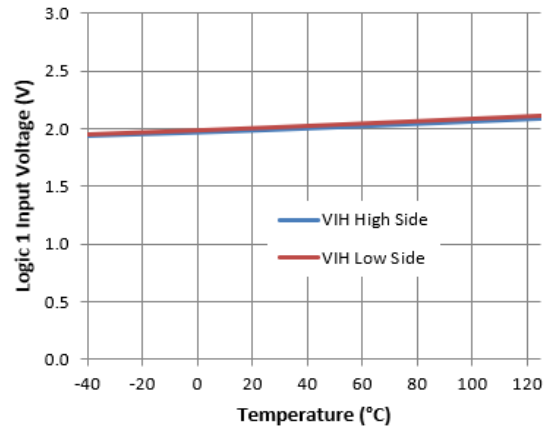

Figure 20. Logic 1 Input Voltage vs. Temperature

Typical Performance Characteristics (Cont.)

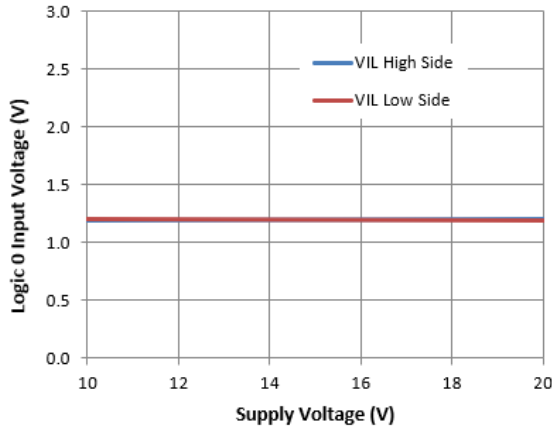

Figure 21. Logic 0 Input Voltage vs. Supply Voltage

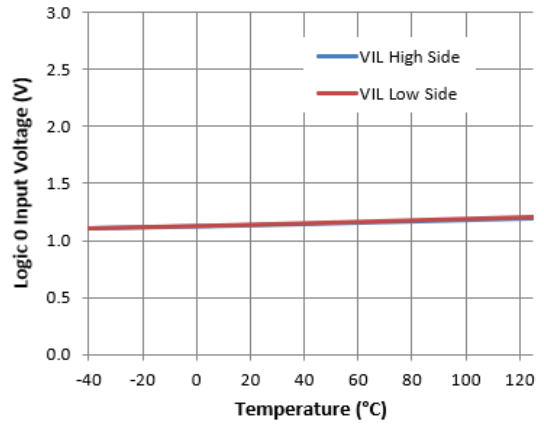

Figure 22. Logic 0 Input Voltage vs. Temperature

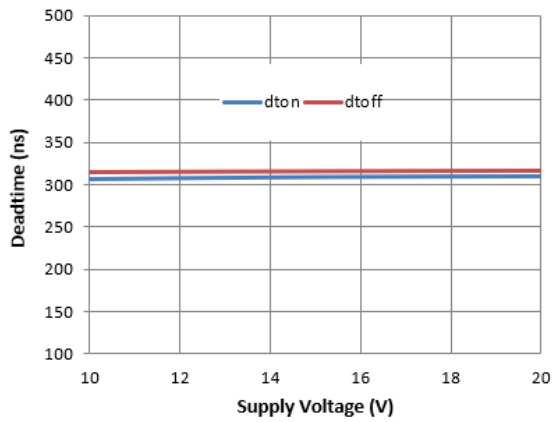

Figure 23. Deadtime vs. Supply Voltage

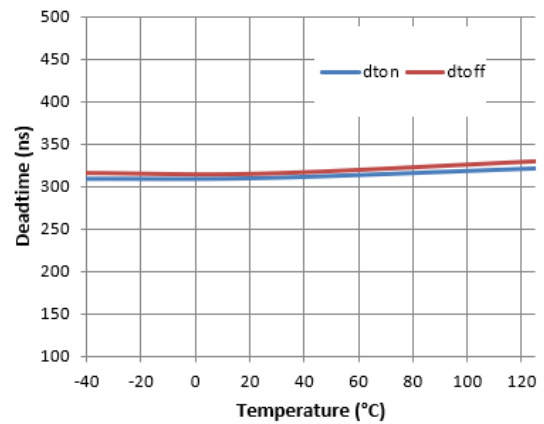

Figure 24. Deadtime vs. Temperature

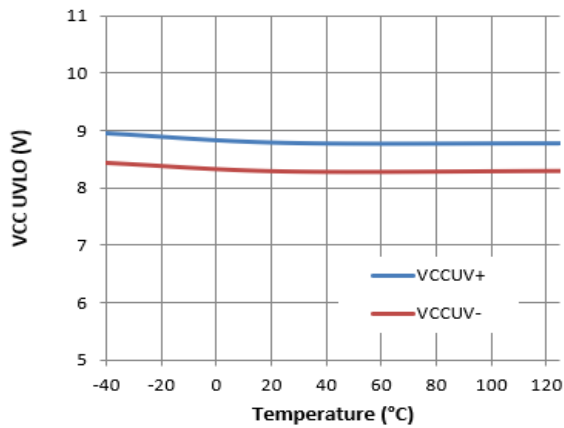

Figure 25. VCC UVLO vs. Temperature

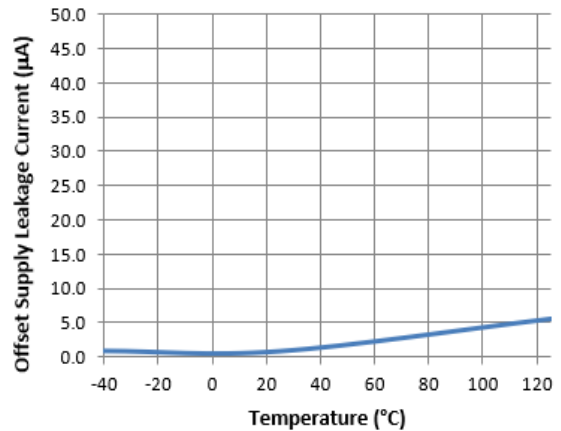
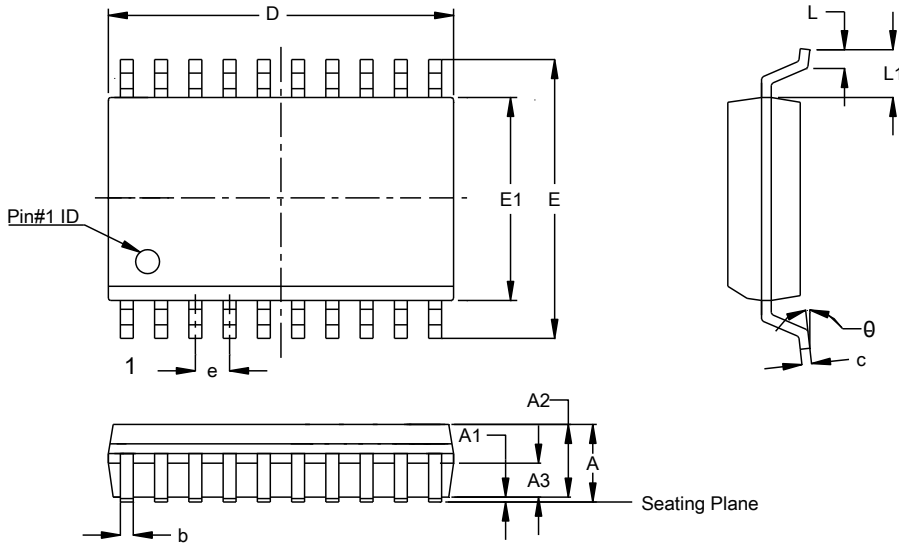

Figure 26. Offset Supply Leakage Current vs. Temperature

Package Outline Dimensions

Please see <http://www.diodes.com/package-outlines.html> for the latest version.

SO-20 (Type TH)



SO-20 (Type TH)			
Dim	Min	Max	Typ
A	--	2.65	--
A1	0.10	0.30	--
A2	2.25	2.35	2.30
A3	0.97	1.07	1.02
b	0.39	0.48	--
c	0.25	0.29	--
D	12.70	12.90	12.80
E	10.10	10.50	10.30
E1	7.40	7.60	7.50
e	1.27 BSC		
L	0.70	1.00	--
L1	1.40 BSC		
θ	0°	8°	--
All Dimensions in mm			

Suggested Pad Layout

Please see <http://www.diodes.com/package-outlines.html> for the latest version.

SO-20 (Type TH)

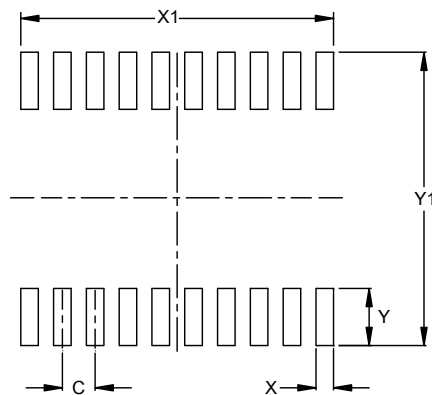

Dimensions	Value (in mm)
C	1.270
X	0.680
X1	12.110
Y	2.200
Y1	11.300

Note: For high voltage applications, the appropriate industry sector guidelines should be considered with regards to creepage and clearance distances between device Terminals and PCB tracking.