

# Getting Started with the Spartan-6 FPGA SP605 Embedded Kit

UG727 (v1.1) June 21, 2010



Xilinx is disclosing this user guide, manual, release note, and/or specification (the “Documentation”) to you solely for use in the development of designs to operate with Xilinx hardware devices. You may not reproduce, distribute, republish, download, display, post, or transmit the Documentation in any form or by any means including, but not limited to, electronic, mechanical, photocopying, recording, or otherwise, without the prior written consent of Xilinx. Xilinx expressly disclaims any liability arising out of your use of the Documentation. Xilinx reserves the right, at its sole discretion, to change the Documentation without notice at any time. Xilinx assumes no obligation to correct any errors contained in the Documentation, or to advise you of any corrections or updates. Xilinx expressly disclaims any liability in connection with technical support or assistance that may be provided to you in connection with the Information.

THE DOCUMENTATION IS DISCLOSED TO YOU “AS-IS” WITH NO WARRANTY OF ANY KIND. XILINX MAKES NO OTHER WARRANTIES, WHETHER EXPRESS, IMPLIED, OR STATUTORY, REGARDING THE DOCUMENTATION, INCLUDING ANY WARRANTIES OF MERCHANTABILITY, FITNESS FOR A PARTICULAR PURPOSE, OR NONINFRINGEMENT OF THIRD-PARTY RIGHTS. IN NO EVENT WILL XILINX BE LIABLE FOR ANY CONSEQUENTIAL, INDIRECT, EXEMPLARY, SPECIAL, OR INCIDENTAL DAMAGES, INCLUDING ANY LOSS OF DATA OR LOST PROFITS, ARISING FROM YOUR USE OF THE DOCUMENTATION.

© Copyright 2009–2010 Xilinx, Inc. XILINX, the Xilinx logo, Virtex, Spartan, ISE, and other designated brands included herein are trademarks of Xilinx in the United States and other countries. All other trademarks are the property of their respective owners.

## Revision History

The following table shows the revision history for this document.

Date	Version	Revision
12/08/09	1.0	Initial Xilinx release.
06/21/10	1.1	Changed “Embedded Development Kit” to “Embedded Kit” throughout. Updated ISE® software tool version from 11.1 to 12.1. Updated procedures and GUI screens for software version 12.1.

# Table of Contents

---

Revision History .....	2
<b>Preface: About This Guide</b>	
Additional Documentation .....	5
Additional Resources .....	6
Conventions .....	6
Typographical .....	6
Online Document .....	7
<b>Getting Started with the Spartan-6 FPGA SP605 Embedded Kit</b>	
Introduction .....	9
SP605 Embedded Kit Contents .....	9
What's Inside the Box .....	9
What's Available Online .....	10
Getting Started with the Video Demonstration .....	10
Processor System Used for the Video Demo .....	10
Video Demo Hardware Requirements .....	11
Video Demo Hardware Setup Instructions .....	11
Running the Video Demo .....	13
Getting Started with the PetaLinux Demonstration .....	14
Processor System Used for the PetaLinux Demo .....	15
PetaLinux Demo Hardware Setup Instructions .....	16
Running the PetaLinux Demo .....	17
<b>Installation and Licensing of ISE Design Suite 12.1</b> .....	18
ISE 12.1 Software Installation .....	18
Downloading and Installing Tool Licenses .....	22
Communicating with the SP605 USB-UART .....	27
Installing the USB-UART driver .....	27
Connecting to the SP605 UART .....	27
Configuring the Host Computer .....	27
Testing the USB-UART Driver Installation .....	29
<b>Next Steps</b> .....	30
Data Sheet .....	32
DS757 SP605 Embedded Kit MicroBlaze Processor Subsystem Data Sheet .....	32
Tutorials .....	32
UG729 SP605 MicroBlaze Processor Subsystem Software Tutorial .....	32
UG728 SP605 MicroBlaze Processor Subsystem Hardware Tutorial .....	32
Reference Designs .....	32
MicroBlaze Processor Subsystem .....	32
MicroBlaze Processor Subsystem with Video Pipeline Demo .....	32
<b>Getting Help and Support</b> .....	33

## Appendix A: Warranty



## About This Guide

---

This guide provides information for getting started with the Spartan®-6 FPGA SP605 Embedded Kit.

### Additional Documentation

The following documents are available for download at <http://www.xilinx.com/products/spartan6/>.

- **Spartan-6 Family Overview**  
This overview outlines the features and product selection of the Spartan-6 family.
- **Spartan-6 FPGA Data Sheet: DC and Switching Characteristics**  
This data sheet contains the DC and switching characteristic specifications for the Spartan-6 family.
- **Spartan-6 FPGA Packaging and Pinout Specifications**  
This specification includes the tables for device/package combinations and maximum I/Os, pin definitions, pinout tables, pinout diagrams, mechanical drawings, and thermal specifications.
- **Spartan-6 FPGA Configuration User Guide**  
This all-encompassing configuration guide includes chapters on configuration interfaces (serial and parallel), multi-bitstream management, bitstream encryption, boundary-scan and JTAG configuration, and reconfiguration techniques.
- **Spartan-6 FPGA SelectIO Resources User Guide**  
This guide describes the SelectIO™ resources available in all Spartan-6 devices.
- **Spartan-6 FPGA Clocking Resources User Guide**  
This guide describes the clocking resources available in all the Spartan-6 devices, including the DCMs and PLLs
- **Spartan-6 FPGA Block RAM Resources User Guide**  
This guide describes the Spartan-6 device block RAM capabilities.
- **Spartan-6 FPGA GTP Transceivers User Guide**  
This guide describes the GTP transceivers available in the Spartan-6 LXT FPGAs.
- **Spartan-6 FPGA DSP48A1 Slice User Guide**  
This guide describes the architecture of the DSP48A1 slice in Spartan-6 FPGAs and provides configuration examples.
- **Spartan-6 FPGA Memory Controller User Guide**

This guide describes the Spartan-6 FPGA memory controller block, a dedicated embedded multi-port memory controller that greatly simplifies interfacing Spartan-6 FPGAs to the most popular memory standards.

- Spartan-6 FPGA PCB Designer's Guide  
This guide provides information on PCB design for Spartan-6 devices, with a focus on strategies for making design decisions at the PCB and interface level.

## Additional Resources

To find additional documentation, see the Xilinx website at:

<http://www.xilinx.com/support/documentation/index.htm>.

To search the Answer Database of silicon, software, and IP questions and answers, or to create a technical support WebCase, see the Xilinx website at:

<http://www.xilinx.com/support>.

## Conventions

This document uses the following conventions. An example illustrates each convention.

### Typographical

The following typographical conventions are used in this document:

Convention	Meaning or Use	Example
Courier font	Messages, prompts, and program files that the system displays	speed grade: - 100
<b>Courier bold</b>	Literal commands that you enter in a syntactical statement	<b>ngdbuild</b> <i>design_name</i>
<b>Helvetica bold</b>	Commands that you select from a menu	<b>File →Open</b>
	Keyboard shortcuts	<b>Ctrl+C</b>
<i>Italic font</i>	Variables in a syntax statement for which you must supply values	<b>ngdbuild</b> <i>design_name</i>
	References to other manuals	See the <i>Command Line Tools User Guide</i> for more information.
	Emphasis in text	If a wire is drawn so that it overlaps the pin of a symbol, the two nets are <i>not</i> connected.
Square brackets [ ]	An optional entry or parameter. However, in bus specifications, such as <b>bus [7:0]</b> , they are required.	<b>ngdbuild</b> [ <i>option_name</i> ] <i>design_name</i>

Convention	Meaning or Use	Example
Braces { }	A list of items from which you must choose one or more	<b>lowpwr</b> = { <b>on</b>   <b>off</b> }
Vertical bar	Separates items in a list of choices	<b>lowpwr</b> = { <b>on</b>   <b>off</b> }
Vertical ellipsis . . .	Repetitive material that has been omitted	IOB #1: Name = QOUT' IOB #2: Name = CLKIN' . . .
Horizontal ellipsis ...	Repetitive material that has been omitted	<b>allow block</b> <i>block_name loc1 loc2 ... locn;</i>

## Online Document

The following conventions are used in this document:

Convention	Meaning or Use	Example
Blue text	Cross-reference link to a location in the current document	See the section “ <a href="#">Additional Resources</a> ” for details. Refer to “ <a href="#">Title Formats</a> ” in <a href="#">Chapter 1</a> for details.
<a href="#">Blue, underlined text</a>	Hyperlink to a website (URL)	Go to <a href="http://www.xilinx.com">http://www.xilinx.com</a> for the latest speed files.





# *Getting Started with the Spartan-6 FPGA SP605 Embedded Kit*

---

## Introduction

The Spartan®-6 FPGA Embedded Kit conveniently delivers the key components of the Xilinx® Embedded Targeted Design Platform (TDP) required for developing embedded software and hardware in a wide range of applications in Broadcast, Industrial, Medical, Aerospace and Defense markets. For software developers, a familiar Eclipse-based IDE, GNU tools, OSes, libraries and a pre-verified reference design enables them to start programming right away. Similarly, hardware designers now have immediate access to a pre-integrated MicroBlaze™ processor subsystem that includes the most commonly used peripheral IP cores, enabling them to begin at once developing their custom logic.

This Getting Started Guide will walk you through the steps to set up the SP605 board and run the out-of-box video and Linux demonstrations that are designed to illustrate the flexibility and capability of a MicroBlaze processor subsystem for embedded design. Then, if you have not already installed the Xilinx ISE® software, you will be directed through the steps to install the software, get updates, and generate a license. Finally this guide will point you to next steps in using the embedded software and hardware tutorials included in this kit.

## SP605 Embedded Kit Contents

### What's Inside the Box

- SP605 Evaluation Board with the XC6SLX45T-3FGG484 FPGA along with:
  - Power Supply
  - Two USB Type-A to Mini-B 5-pin cables
  - Ethernet Cable
  - VGA to DVI Adapter
  - Compact Flash card - 2 GB (with Embedded Kit demo)
- ISE Design Suite Embedded Edition: (device-locked) for Spartan-6 LX45T FPGA
- Xilinx ISE Design Suite 12.1 DVD, which includes:
  - ISE Foundation with ISE Simulator
  - PlanAhead Design and Analysis Tool
  - Embedded Development Kit (EDK)
  - Xilinx Platform Studio (XPS)

- Software Development Kit (SDK)
- ChipScope™ Pro logic analyzer
- Documentation
  - SP605 Hardware Setup Guide
  - UG727 Getting Started with the Spartan-6 FPGA SP605 Embedded Kit
  - DS757 SP605 Embedded Kit MicroBlaze Processor Subsystem Data Sheet
  - UG728 SP605 MicroBlaze Processor Subsystem Hardware Tutorial
  - UG729 SP605 MicroBlaze Processor Subsystem Software Tutorial
- Reference Designs and Demonstrations
  - Base MicroBlaze Processor Sub System
  - Video Demo
- Reference designs, demonstrations, documentation, and applications delivered on USB Flash drive to get started quickly

### What's Available Online

- License for ISE Design Suite 12.1 Embedded Edition
  - <http://www.xilinx.com/getproduct>
  - <http://www.xilinx.com/tools/faq.htm>
- Embedded Kit home page with Documentation and Reference Designs
  - <http://www.xilinx.com/s6embkit>
- Technical Support
  - <http://www.xilinx.com/support/>

### Getting Started with the Video Demonstration

This Spartan-6 Embedded Kit comes with a video demo available on the provided Compact Flash card. You can run this demo before installing any additional tools to get an overview of the features of the SP605 Evaluation Board using a MicroBlaze Processor Subsystem in the Spartan-6 LX45T FPGA.

### Processor System Used for the Video Demo

The provided demos use a pre-built Spartan-6 FPGA design ([Figure 1](#)) with the following features:

- MicroBlaze soft processor
- External DDR3 Memory Interface
- External Flash Memory Interface
- On-chip Memory (Block RAM)
- Tri-Mode Ethernet MAC (evaluation license)
- UART (connected from SP605 board via the USB-UART connector)
- Interrupt Controller (Intc) and Timer
- Compact Flash Interface (System ACE™ technology)
- GPIO (LEDs, LCD, Switches)
- Video Pipeline DSP Cores

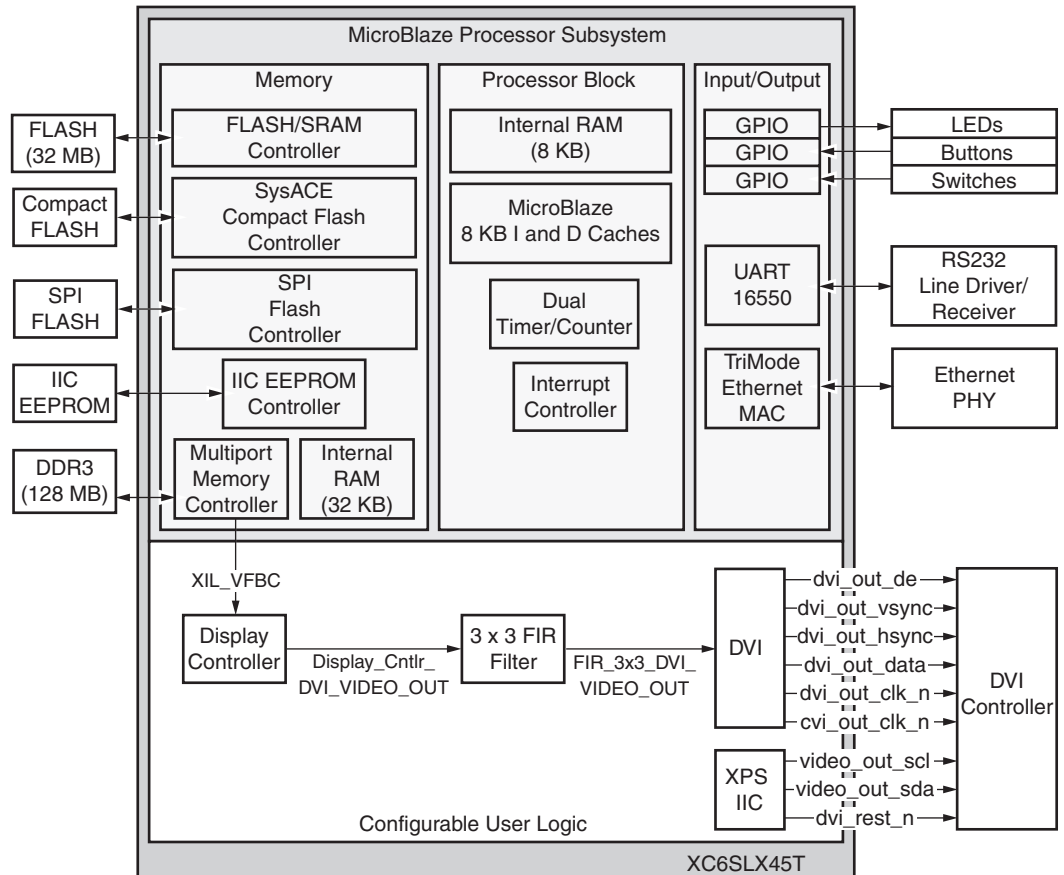

UG727\_01\_051110

Figure 1: Spartan-6 FPGA Video Demo System

**Note:** Instructions on building the Video Demo system are detailed in [UG728 SP605 MicroBlaze Processor Subsystem Hardware Tutorial](#).

## Video Demo Hardware Requirements

In addition to the equipment supplied with the Embedded Kit, you will also need the following to run the Video Demo:

- DVI cable and DVI Monitor
- or
- DVI to VGA adapter, VGA Cable, and VGA Monitor

## Video Demo Hardware Setup Instructions

1. Connect the Ethernet Cable directly to a PC. Set the IP address of the PC to **192.168.1.100**. You will need to return the IP address of the PC back to its original setting after running the demo.

**Note:** The demo uses a hard coded MAC address and a fixed IP address of **192.168.1.10** and will not connect to your regular LAN network using DHCP. Do not connect more than one board to the same network segment.

- Connect either a DVI monitor to the SP605 board connector shown in [Figure 2](#) or use the provided DVI/VGA adapter to connect to a VGA monitor. Ensure that the monitor is turned ON and its input selected to DVI or VGA appropriately.



UG727\_02\_111309

Figure 2: SP605 DVI Connector

- Confirm that the SP605 jumper settings are at default, as shown in [Table 1](#).

Table 1: SP605 Jumper Settings

Jumper REFDES	Function	Default
<b>FMC JTAG Bypass</b>		
J19	Exclude FMC LPC connector J2	Jump 1-2
<b>SFP Module</b>		
J22	SFP Full BW	Jump 1-2
J44	SFP Enabled	Jump 1-2
<b>SPI Memory Select</b>		
J46	SPI Select SPI X4 Memory U32	Jump 1-2
<b>System ACE CF Error LED</b>		
J60	System ACE CF Error LED DS18 Enabled	Jump 1-2

- Insert the provided Compact Flash card into the board as shown in [Figure 3](#).
- Set the System ACE DIP switches shown in [Figure 3](#) to the settings listed in [Table 2](#).

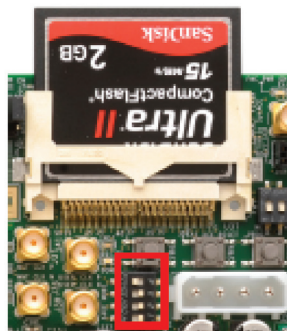

UG727\_03\_111309

Figure 3: Compact Flash Card Installation and DIP Switch Settings

Table 2: Video Demo System ACE DIP Switch Settings

DIP Switch	Switch Position
1	Off
2	Off
3	Off
4	On

Now you are ready to run the pre-built Video Demo provided with this kit. Follow the next set of instructions to run the demo.

## Running the Video Demo

1. If the SP605 board is not already powered on, plug in the power adapter to local AC power. Plug the 12V power cable into the board connector on J18. Turn on the power by switching the SW2 to the "ON" position.
2. After a couple of seconds, the Xilinx logo should be displayed on the DVI (or VGA) monitor.
3. Open a web browser on the host computer and set the URL to **192.168.1.10**.
4. You should see the web page shown in Figure 4. The various selections in the Web page and the operation performed are described in Table 3

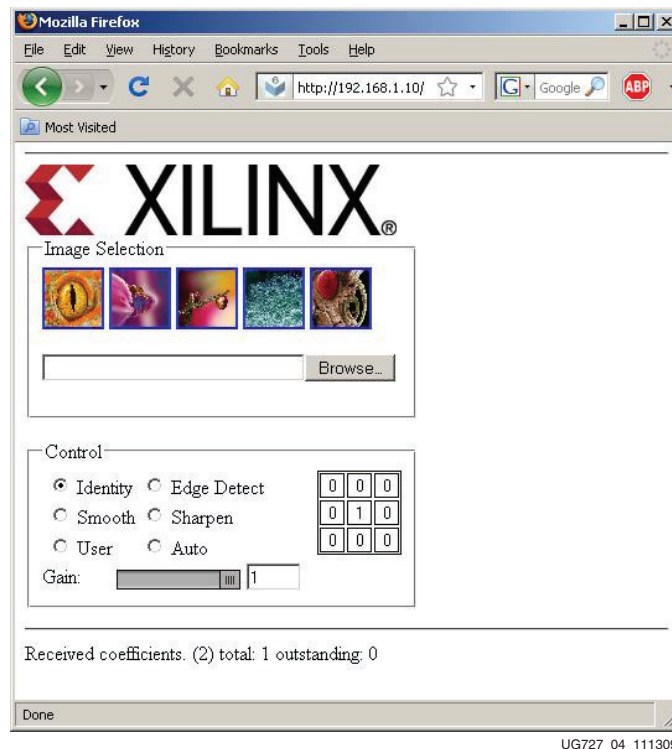

Figure 4: Video Demo Web Page

Table 3: Video Demo Web Page Selections

Selection	Operation
Image Selection	Either select one of the images shown or browse to an uncompressed 24BPP Windows bitmap image in the SP605_Embedded_Kit\Test_Images directory. This image is sent to the MicroBlaze Processor Subsystem and displayed. FIR filters are applied to the image.
Identity	Output image is unmodified.
Edge Detect	Areas of high contrast are detected and shown in white; the remainder of the image is black.
Smooth	A slight blurring effect is applied to the output image.
Sharpen	Contrast is increased in the output image.
User	Manually entered coefficients are sent to the MicroBlaze Processor Subsystem and applied to the output image.
Auto	The MicroBlaze Processor Subsystem continuously cycles from Identity to Edge Detect effects until a new selection is chosen.
Gain	Slider controls the output image gain (0.0 - 1.0).

5. Try clicking the various options that adjust the image and notice the affect on the image displayed on the monitor.
6. Either select one of the displayed images or click **Browse** and select a new image from the **SP605\_Embedded\_Kit\Test\_Images** directory.  
The selected image should now be displayed on the DVI (or VGA) monitor.
7. Repeat [step 5](#) and [step 6](#) as desired.

**Congratulations!** You have now run a Video demo using the SP605 board with Spartan-6 LX45T FPGA and the MicroBlaze soft processor. Since you are provided with a fully configured MicroBlaze Processor Subsystem, you can start developing embedded software. Also since you are using an FPGA, you can fully customize this processor system. In order to do this, you have to install the ISE Design Suite 12.1 tools and the USB-UART driver on your computer. The [Installation and Licensing of ISE Design Suite 12.1](#) section of this document will guide you through these steps.

## Getting Started with the PetaLinux Demonstration

This Spartan-6 Embedded Kit comes with a PetaLinux demo available on the provided Compact Flash card. PetaLinux is an Embedded Linux System Development Kit specifically targeting FPGA-based system-on-chip designs. You can run this demo to get an overview of the features of the SP605 Evaluation Board using a MicroBlaze Processor Subsystem in the Spartan-6 LX45T FPGA. More information about PetaLogix, including how to evaluate or purchase it, can be found at <http://www.petalogix.com/petalinux>.

## Processor System Used for the PetaLinux Demo

The provided PetaLinux demo uses a pre-built Spartan-6 FPGA design (Figure 5) with the following features:

- MicroBlaze soft processor
- External DDR3 Memory Interface
- External Memory Controller (EMC) for Flash memory
- On-chip Memory (Block RAM)
- Tri-Mode Ethernet MAC (evaluation license)
- UART (connected from SP605 board via the USB-UART connector)
- Interrupt Controller (Intc) & Timer
- Compact Flash Interface (System ACE CF technology)
- GPIO (LEDs, LCD, Switches)

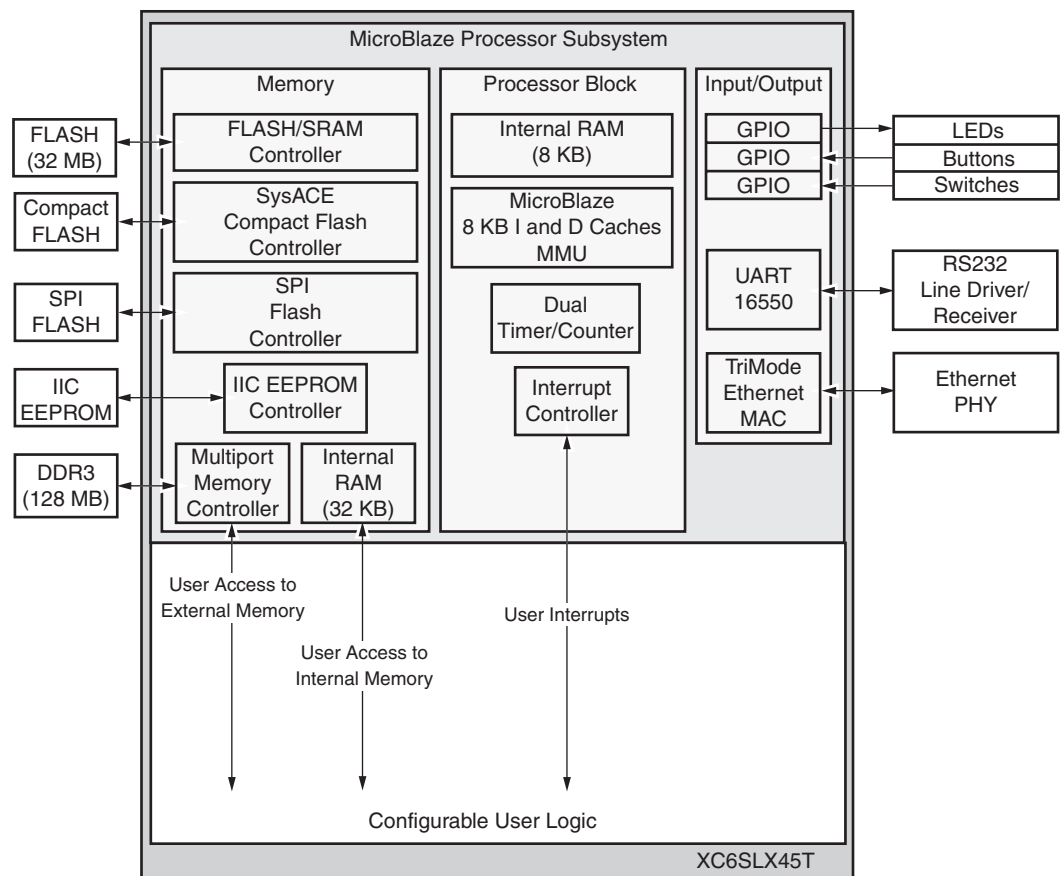

Figure 5: Spartan-6 FPGA PetaLinux Demo System

**Note:** Details about the system used for the PetaLinux demo can be found in [DS757 SP605 Embedded Kit MicroBlaze Processor Subsystem Data Sheet](#).

## PetaLinux Demo Hardware Setup Instructions

1. Install the USB-UART driver to your host computer by executing the steps specified in the [Communicating with the SP605 USB-UART](#) section.
2. Confirm that the SP605 jumper settings are at default, as shown in [Table 4](#).

**Table 4: SP605 Jumper Settings**

Jumper REFDES	Function	Default
<b>FMC JTAG Bypass</b>		
J19	Exclude FMC LPC connector J2	Jump 1-2
<b>SFP Module</b>		
J22	SFP Full BW	Jump 1-2
J44	SFP Enabled	Jump 1-2
<b>SPI Memory Select</b>		
J46	SPI Select SPI X4 Memory U32	Jump 1-2
<b>System ACE CF Error LED</b>		
J60	System ACE CF Error LED DS18 Enabled	Jump 1-2

3. Insert the provided Compact Flash card into the board as shown in [Figure 3](#).
4. Set the System ACE DIP switches as shown in [Table 5](#).

**Table 5: PetaLinux Demo System ACE DIP Switch Settings**

DIP Switch	Switch Position
1	On
2	Off
3	Off
4	On

**Note:** This is the same DIP switch as shown in [Figure 3](#). However, [Figure 3](#) shows the switch settings for the Video Demo, not the PetaLinux Demo.

5. If the SP605 board is not powered on, plug in the power adapter to local AC power. Plug the 12V power cable into the board connector on J18. Turn on the power by switching the SW2 to the "ON" position.
6. Open and configure a serial communications terminal utility program with the following settings:
  - Baud Rate: **115200**
  - Data: **8** bit
  - Parity: **None**
  - Stop: **1** bit
  - Flow Control: **None**

**Note:** Note: The baud rate (115200) for the PetaLinux demo is not the same baud rate (9600) used for the Video demo.



Now you are ready to run the PetaLinux pre-built demo provided with this kit. Follow the next set of instructions to run the demo.

## Running the PetaLinux Demo

7. Press the SYSACE Reset button (SW9).

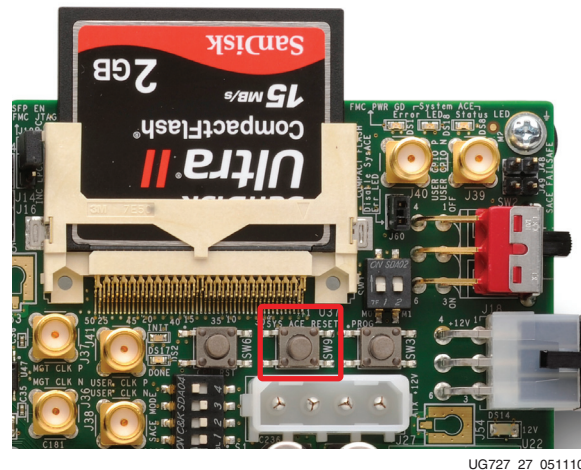

Figure 6: SP605 SYSACE RESET Button

8. After ~20 seconds, the PetaLinux boot output should be displayed on the serial communications window as shown in Figure 7.

```

Welcome to
PetaLinux
on Xilinx-SP605-MMU-BSRD-11.4

Xilinx-SP605-MMU-BSRD-11.4 login:

```

UG727\_14\_111309

Figure 7: PetaLinux UART Output

**Note:** The PetaLinux boot image in Figure 7 refers to version 11.4. However, this is the valid boot image for the 12.1 release.

9. Login with user name as `root` and password as `root`.
10. The PetaLinux image provided with the Embedded Kit supports many basic Linux commands. A list of some of the commands and tools available to be run can be found in the `/bin` directory.

**Congratulations!** You have now run the PetaLinux demo using the SP605 board with Spartan-6 LX45T FPGA and the MicroBlaze soft processor. Because you are provided with a fully configured MicroBlaze Processor Subsystem, you can start developing embedded software. Also because you are using an FPGA, you can fully customize this processor system. To do this, you have to install the ISE Design

Suite 12.1 tools on your computer. The [Installation and Licensing of ISE Design Suite 12.1](#) section of this document will guide you through these steps.

## Installation and Licensing of ISE Design Suite 12.1

This SP605 Embedded Kit comes with entitlement to a full seat of the ISE Design Suite: Embedded Edition that is device locked to a Spartan-6 LX45T. This software can be installed from the DVD or the Web installer can be downloaded from <http://www.xilinx.com/support/download/index.htm>.

### ISE 12.1 Software Installation

1. Run the ISE Design Suite 12.1 Installer:
  - a. Option 1: Insert the ISE Design Suite 12.1 DVD included in this kit into your computer
    - If the Installer does not start automatically, run the “xsetup” executable from the DVD
  - b. Option 2: Run the Web Installer that you can download from <http://www.xilinx.com/support/download/index.htm>

You will be prompted with a Welcome dialog (Figure 8), two License agreements (Figure 9 and Figure 10), a selection of which tool edition to install (Figure 11), installation options (Figure 12), and an opportunity to select where you would like to install the software (Figure 13).

**Note:** It is recommended that you accept the two license agreements, install the ISE Design Suite: Embedded Edition, and accept the default install location.

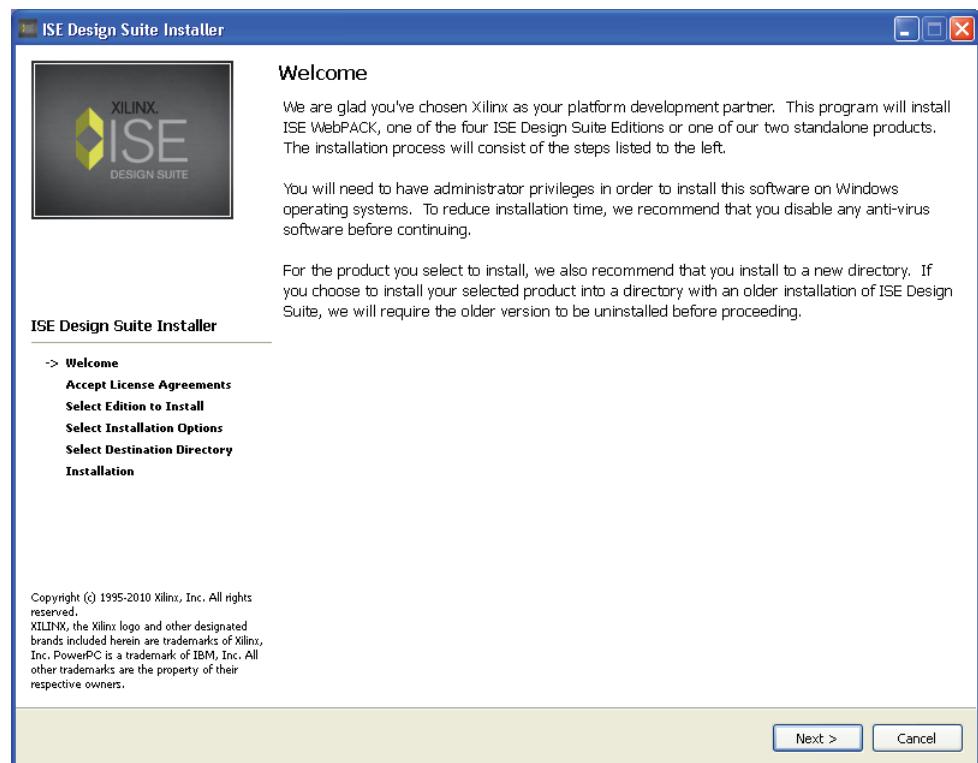

UG727\_07\_051110

Figure 8: ISE Design Suite Install Welcome Screen

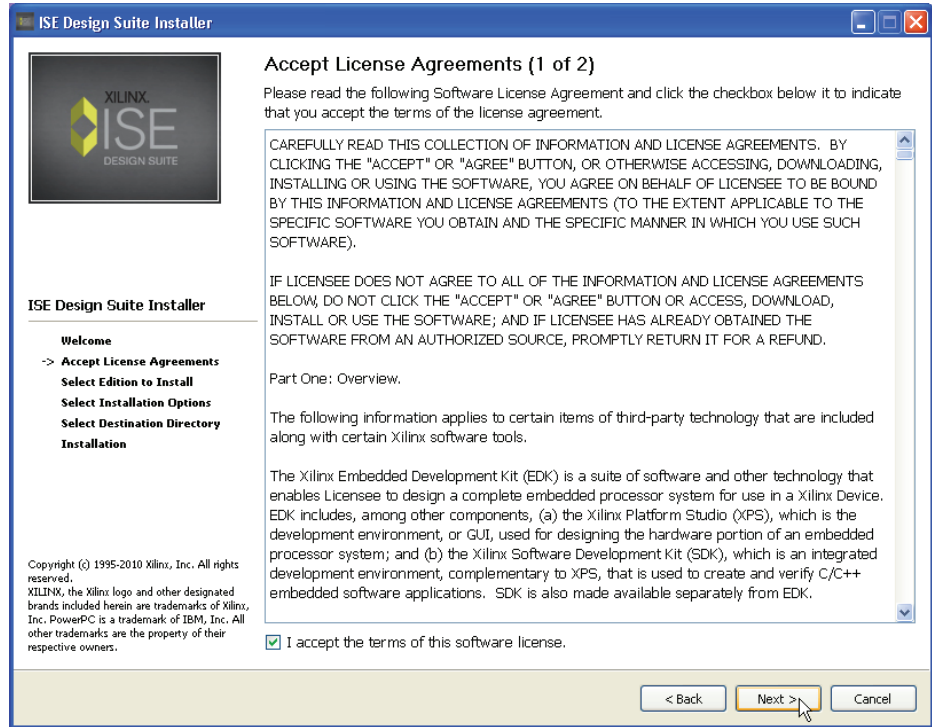

Figure 9: ISE Design Suite Third-Party Usage License Agreement

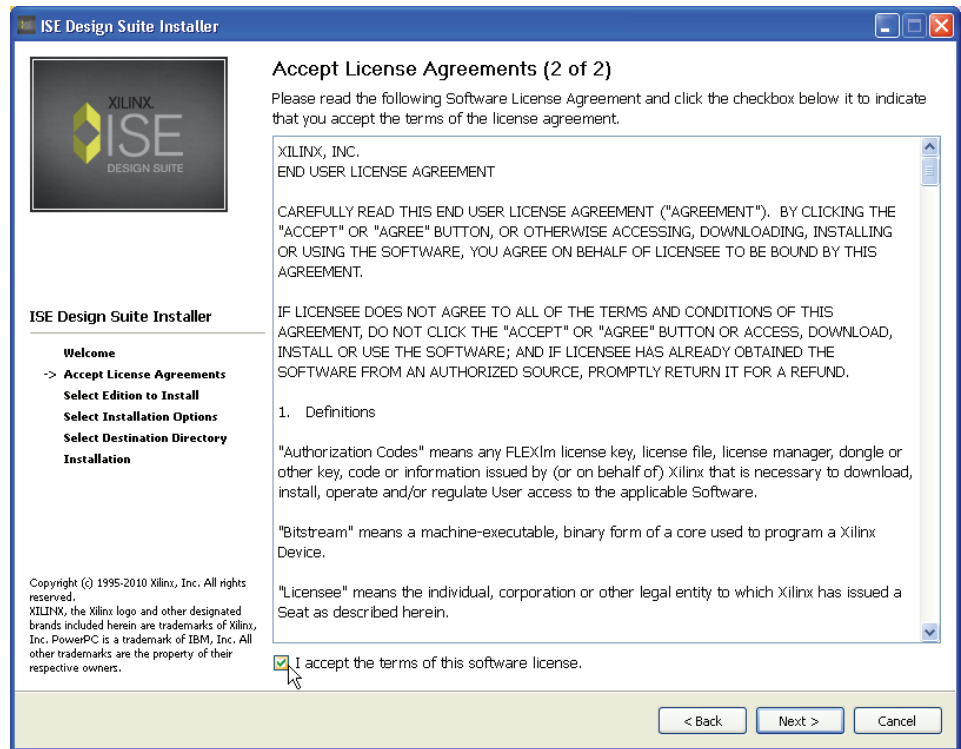
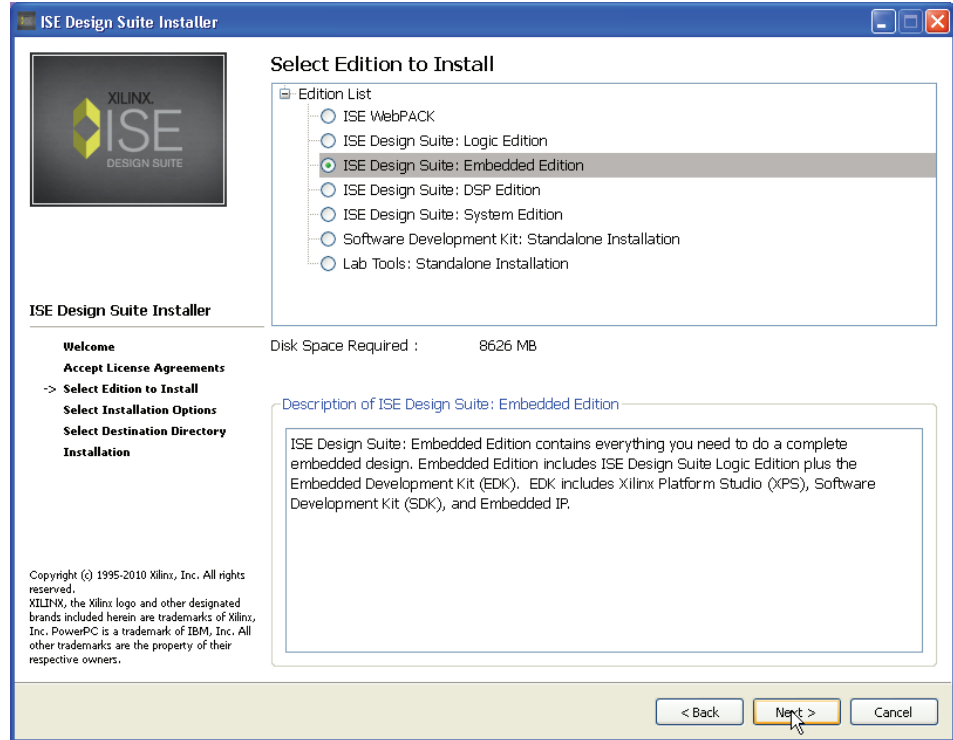
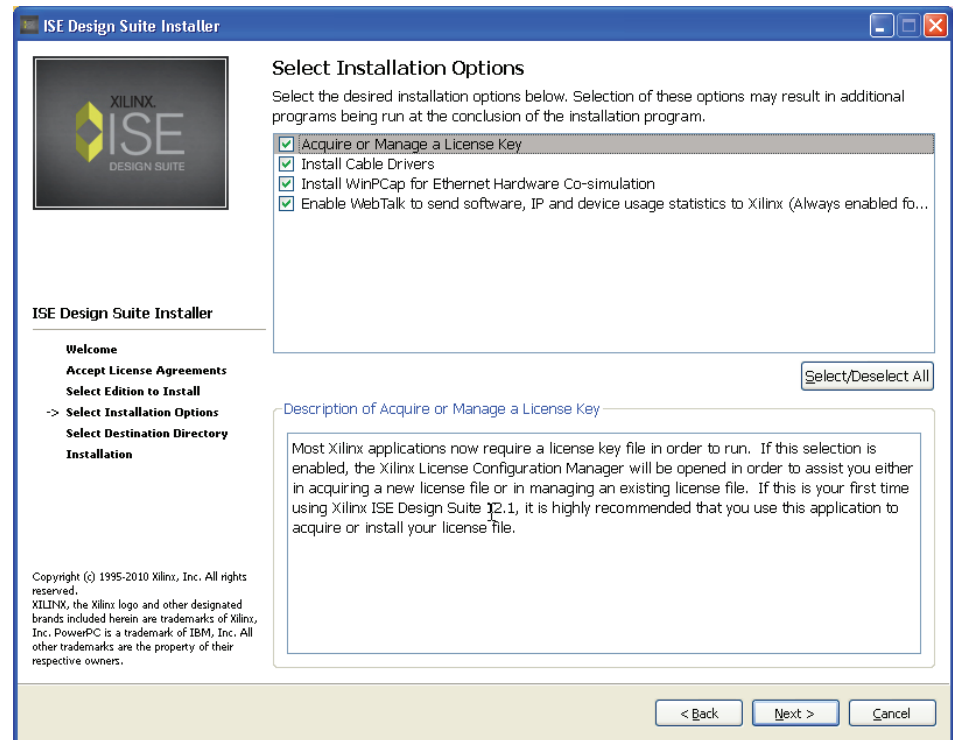

Figure 10: ISE Design Suite End-User License Agreement



UG727\_10\_042710

Figure 11: ISE Design Suite Edition Selection



UG727\_11\_042710

Figure 12: Installation Options

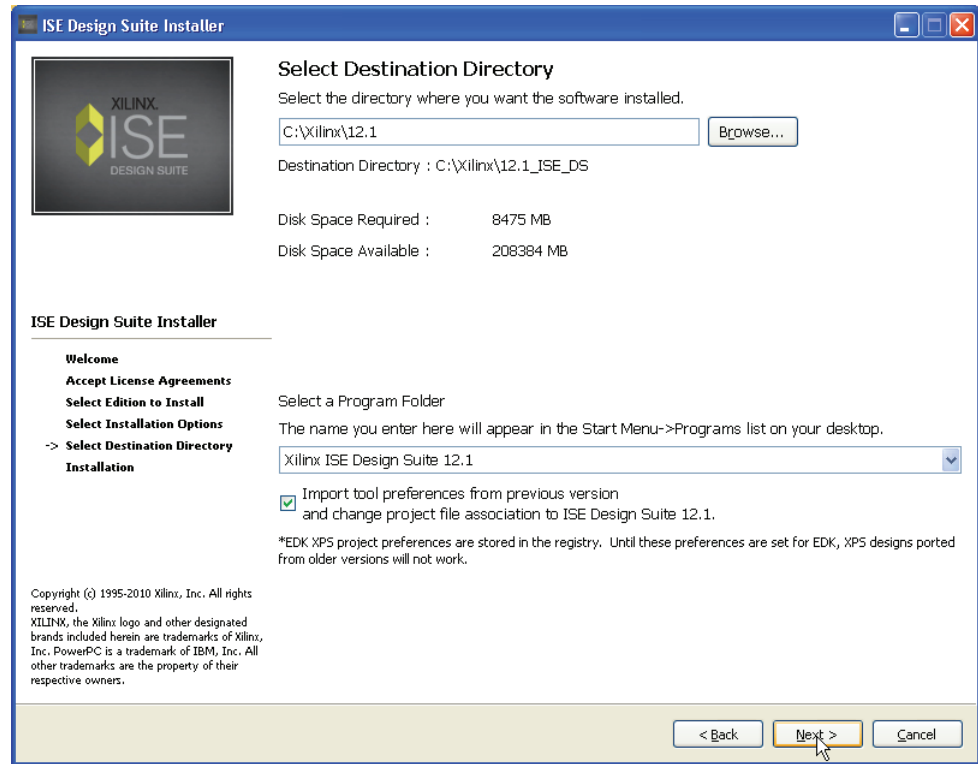

UG727\_12\_040710

Figure 13: ISE Design Suite Destination Directory

2. Follow the rest of the steps presented by the installer, accepting the defaults to complete the installation.

**Note:** The DVD installation might take about one hour. The Web installation might take about three to ten hours based on Internet download speeds.

3. When the installation has completed, you will see the window shown in Figure 14. Click **Finish**.

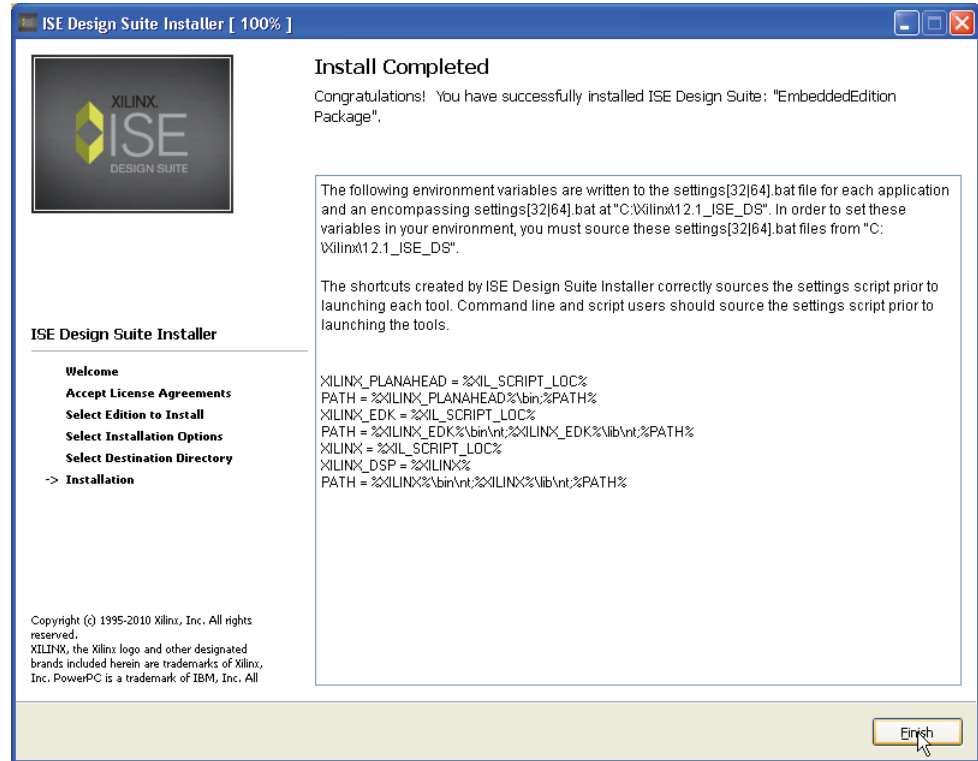

UG727\_13\_040710

Figure 14: Installation Completed

4. Click **Close** to exit the Xilinx License Configuration Manager. The license for the software will be acquired in the [Downloading and Installing Tool Licenses](#) section.
5. Exit the installation.
6. Reboot your machine.

## Downloading and Installing Tool Licenses

1. Visit the Xilinx software registration and entitlement site at <http://www.xilinx.com/getproduct>.
2. This launches your Web browser and takes you to the Xilinx product download and licensing site (Figure 15).

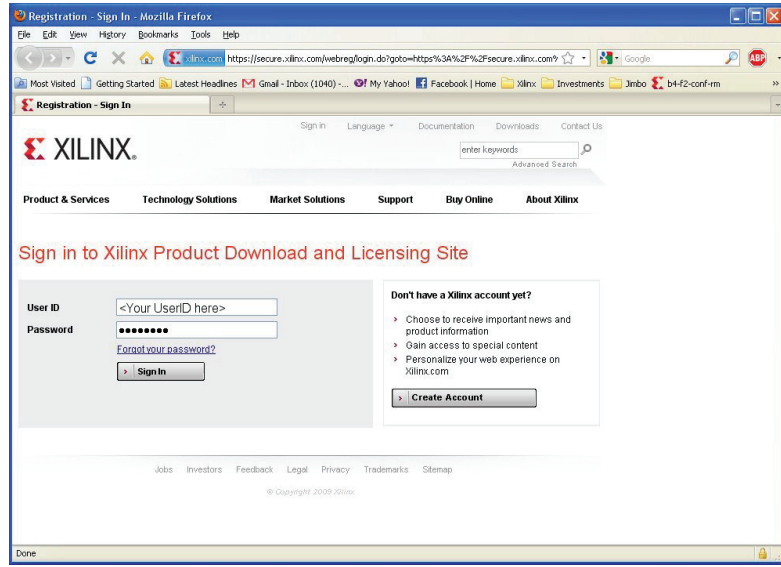
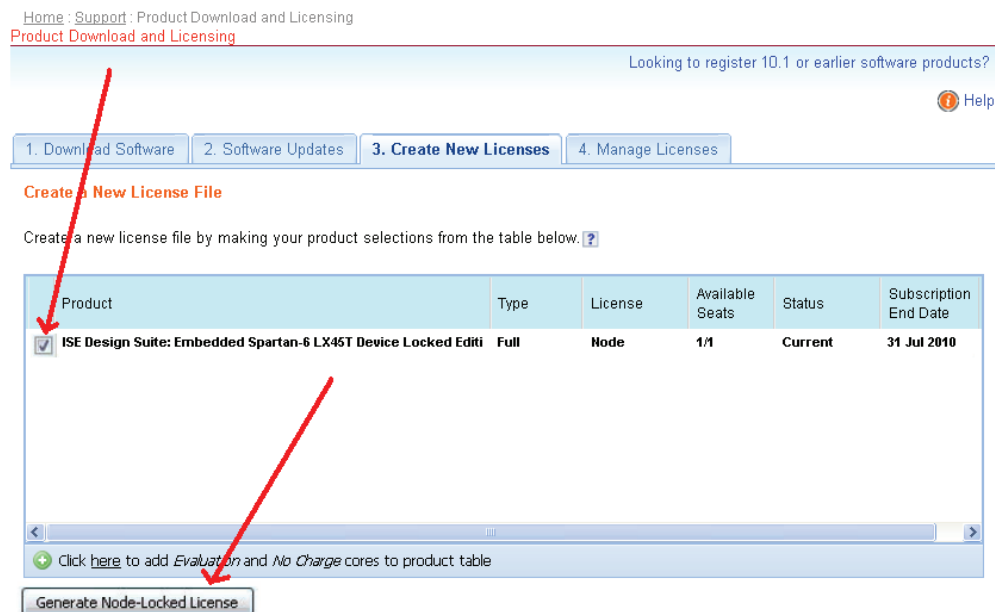

Figure 15: Sign In to Xilinx Product Download and Licensing Site

3. Log in if you already have an existing account or create an account if needed.

**Note:** Your user name and password are provided in an e-mail sent when you ordered the kit. If you do not have this e-mail, or have lost this e-mail, please contact Xilinx customer support. They will be able to provide you with the support to access your account <http://www.xilinx.com/support/techsup/tappinfo.htm>.

4. After logging in, you may be requested to verify your shipping address. Click **Next** after the shipping address has been verified or updated.
5. Check the product **ISE Design Suite Embedded Spartan-6 LX45T Device Locked Edition** and click on **Generate Node-Locked License** as shown in Figure 16.



UG727\_20\_113009

Figure 16: Xilinx Entitlement Center

- Follow the instructions to generate the license by providing your Host OS information and Host ID (Disk Serial number or Ethernet MAC address) as shown in Figure 17 and click **Next**.

**Note:** Laptop users may want to select their Disk ID or Wireless Ethernet card HostID. Laptops on docking stations might find there are three Ethernet HostIDs to choose from. If you select a docking station HostID, then you will only have a license when you are docked. It is best to avoid the HostID of your RJ45 Ethernet connection on Laptop computers, as some Ethernet adapters will power down when not plugged into the network. If you do select an Ethernet adapter, it is best to select your wireless card.

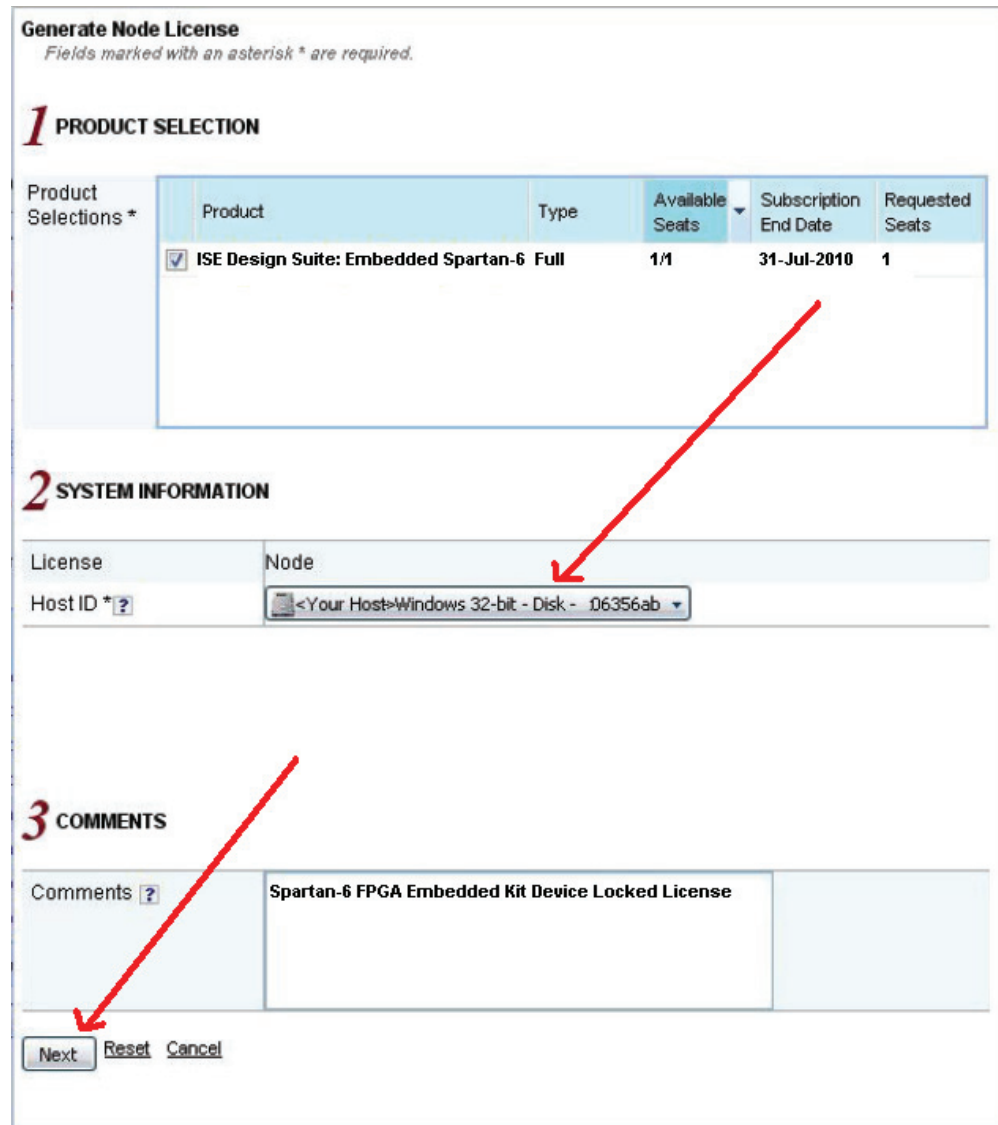

**Generate Node License**  
*Fields marked with an asterisk \* are required.*

### 1 PRODUCT SELECTION

Product Selections *	Product	Type	Available Seats	Subscription End Date	Requested Seats
<input checked="" type="checkbox"/>	ISE Design Suite: Embedded Spartan-6 Full		1/1	31-Jul-2010	1

### 2 SYSTEM INFORMATION

License	Node
Host ID * <sup>?</sup>	<Your Host>Windows 32-bit - Disk - .06356ab

### 3 COMMENTS

Comments <sup>?</sup>	
	Spartan-6 FPGA Embedded Kit Device Locked License

UG727\_21\_113009

Figure 17: Selecting Your Host ID



- Review your license request as show in Figure 18 and click **Next**.

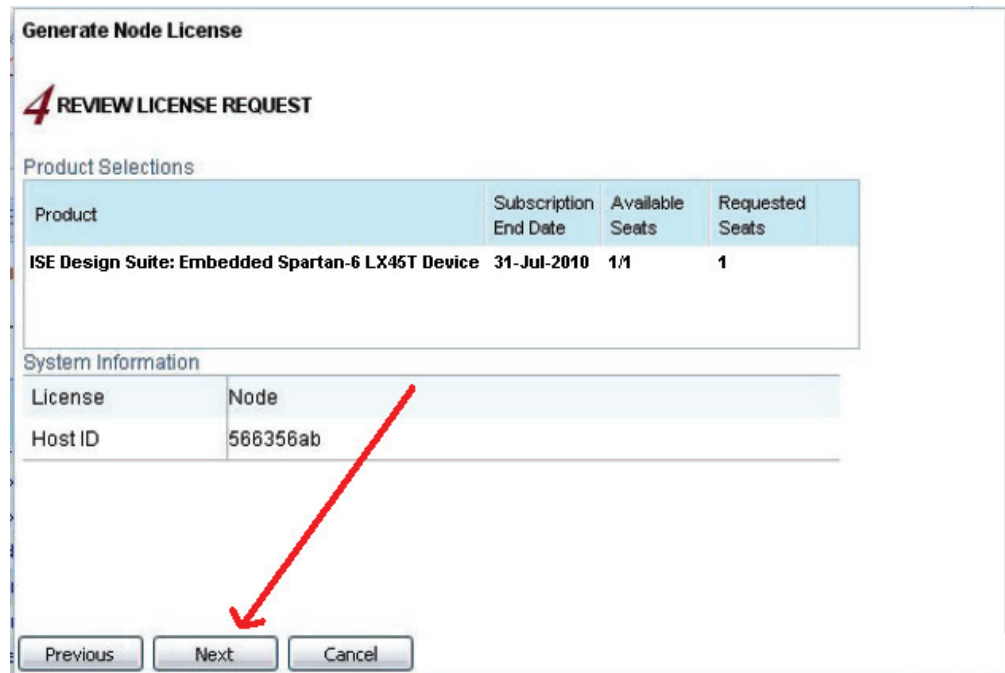

Figure 18: Reviewing Your License Request

- The generated license is e-mailed to you in an E-mail similar to the one shown in Figure 19.

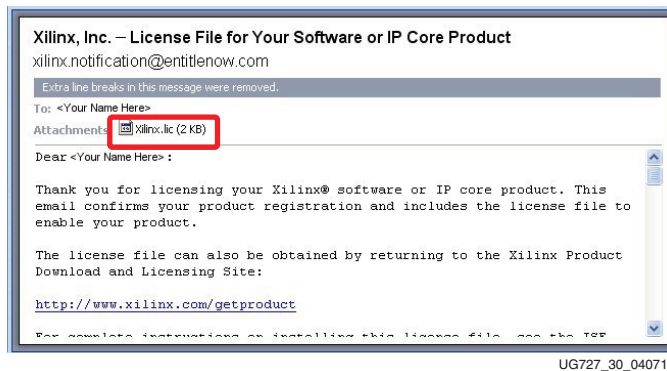
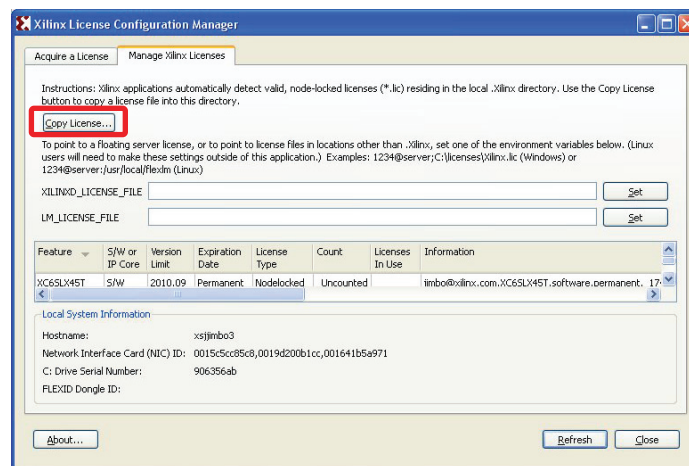

Figure 19: Xilinx License Notification E-mail

- Start the Xilinx License Manager (**Start > All Programs > Xilinx ISE Design Suite 12.1 > Accessories > Manage Xilinx Licenses**) and click on **Copy License** to install the license on your computer.



UG727\_24\_113009

Figure 20: Manage Xilinx License Tab

- Navigate to where you saved the `xilinx.lic` file and select it. See Figure 21.

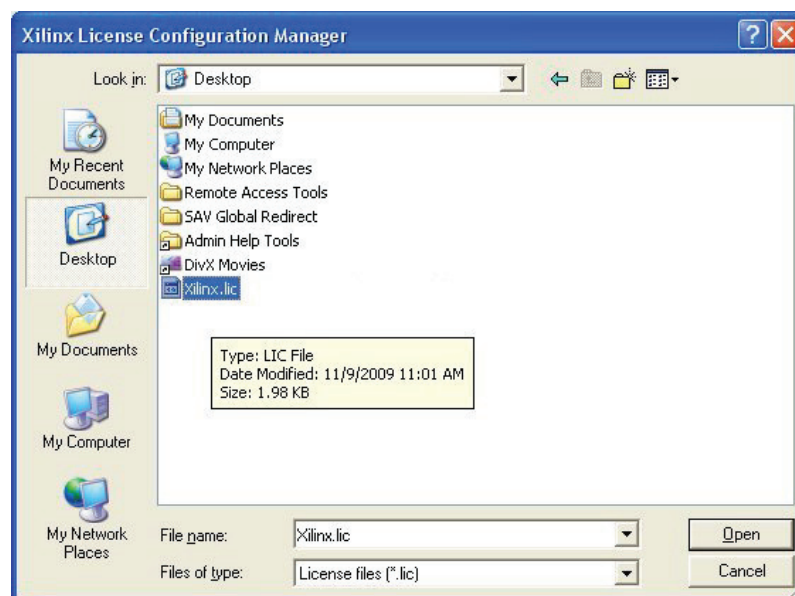

UG727\_23\_111309

Figure 21: Select the `xilinx.lic` File

- You have now successfully installed your ISE software license. Click **OK** on the Success Dialog (Figure 22) and close the Xilinx License Configuration Manager.

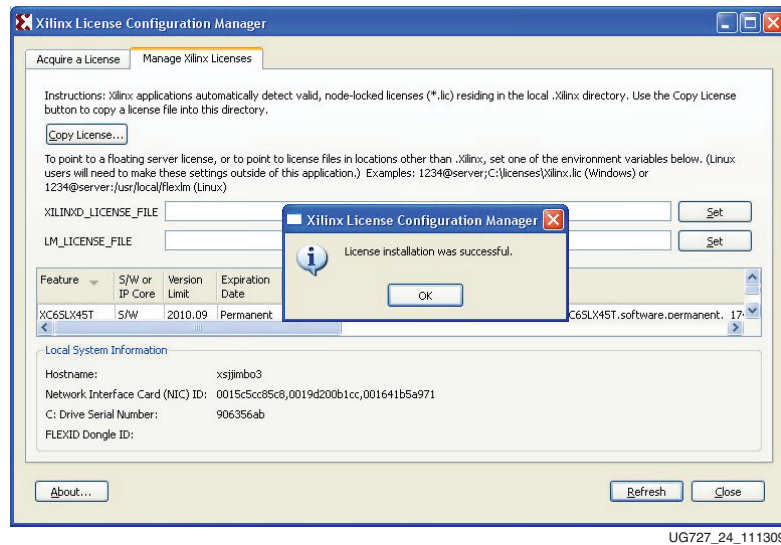

Figure 22: License Installation Successful

**Congratulations!** You have now installed the ISE Design Suite 12.1 tools and set up the licenses for the Embedded Edition of the tools. You are now ready to use Xilinx ISE Design Suite 12.1 Embedded Edition to create or modify your custom Embedded Systems using the MicroBlaze soft processor.

For detailed information on licensing & installation, please refer the following guide: [http://www.xilinx.com/support/documentation/sw\\_manuals/xilinx12/irn.pdf](http://www.xilinx.com/support/documentation/sw_manuals/xilinx12/irn.pdf).

## Communicating with the SP605 USB-UART

### Installing the USB-UART driver

- Execute the installer for the Silicon Labs USB-UART Virtual COM Port (VCP) driver from the `Drivers_and_Tools` folder on the USB drive shipped with your SP605 Embedded Kit.

`Drivers_and_Tools\CP210x_VCP_Win2K_XP_S2K3.exe`

- Follow the installer instructions. Restart your computer when instructed to do so.

### Connecting to the SP605 UART

- Connect a USB Type-A to Mini-B 5-pin cable between the SP605 USB-UART connector (J23) and the host computer.
- Power on the SP605 Evaluation Board if it is not already powered on.

### Configuring the Host Computer

- Right-click on **My Computer** and select **Properties**. Select the **Hardware** tab. Click on **Device Manager**.

6. Expand the **Ports (COM & LPT)** entry as shown in [Figure 23](#). This shows the COM port assigned to the Silicon Labs CP210x USB to UART bridge. This is the COM port to use in the serial communications program.

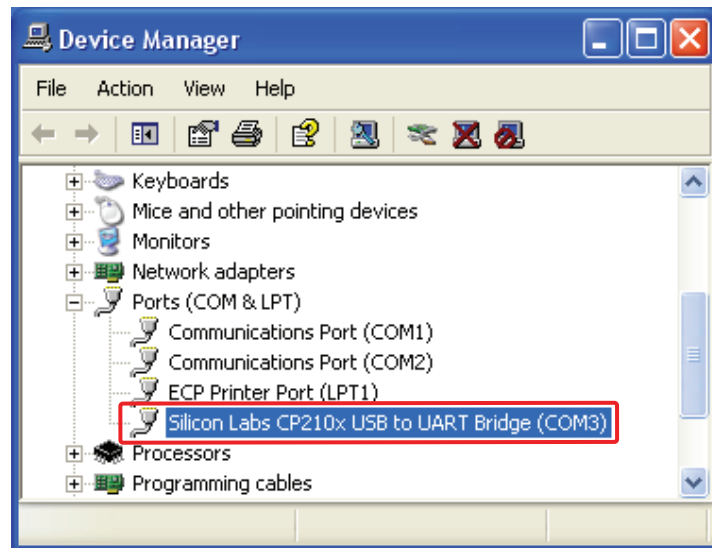

UG727\_25\_051110

Figure 23: Silicon Labs USB to UART Bridge Properties

- Note:** If the Silicon Labs CP210x USB to UART bridge does not appear in the Ports list, a reboot of the computer might be required. After rebooting, repeat step 5 and step 6.
7. If you are using TeraTerm as your serial communications utility program, right-click on the **Silicon Labs CP210x USB to UART bridge** and select **Properties**.
    - a. Click on the **Port Settings** tab and then click **Advanced**.
    - b. Set the COM port to an open COM port setting from COM1 to COM4. Note that the COM port setting for your system may not be the one shown in [Figure 24](#).

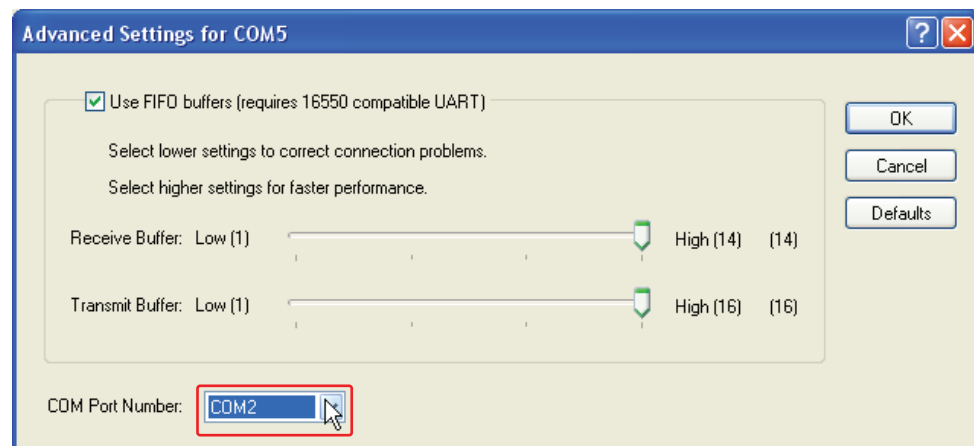

UG727\_26\_111309

Figure 24: Setting the COM port for the Silicon Labs USB to UART Bridge Driver

8. Click **OK** to exit all open windows.

## Testing the USB-UART Driver Installation

9. Start a serial communication program like HyperTerminal or TeraTerm on the Host PC with the following settings:
  - Baud Rate: **9600**
  - Data Bits: **8**
  - Parity: **None**
  - Stop Bits: **1**
  - Flow Control: **None**
10. Set the SACE MODE DIP switches as shown in [Figure 3](#) and listed in [Table 2](#).
11. Press the SYS ACE RESET button (SW9) shown in [Figure 25](#) to re-load the Video Demo. Make sure the Compact FLASH card is still inserted.

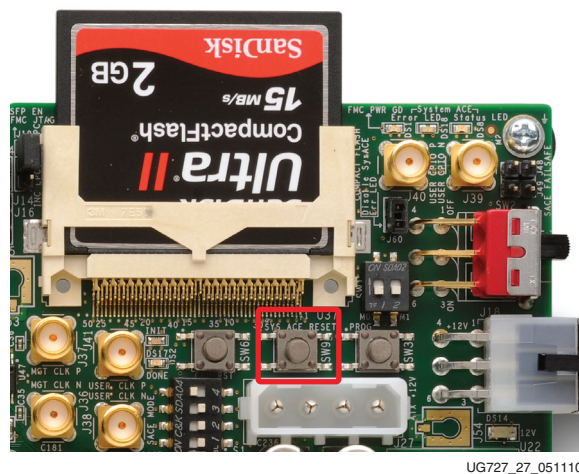
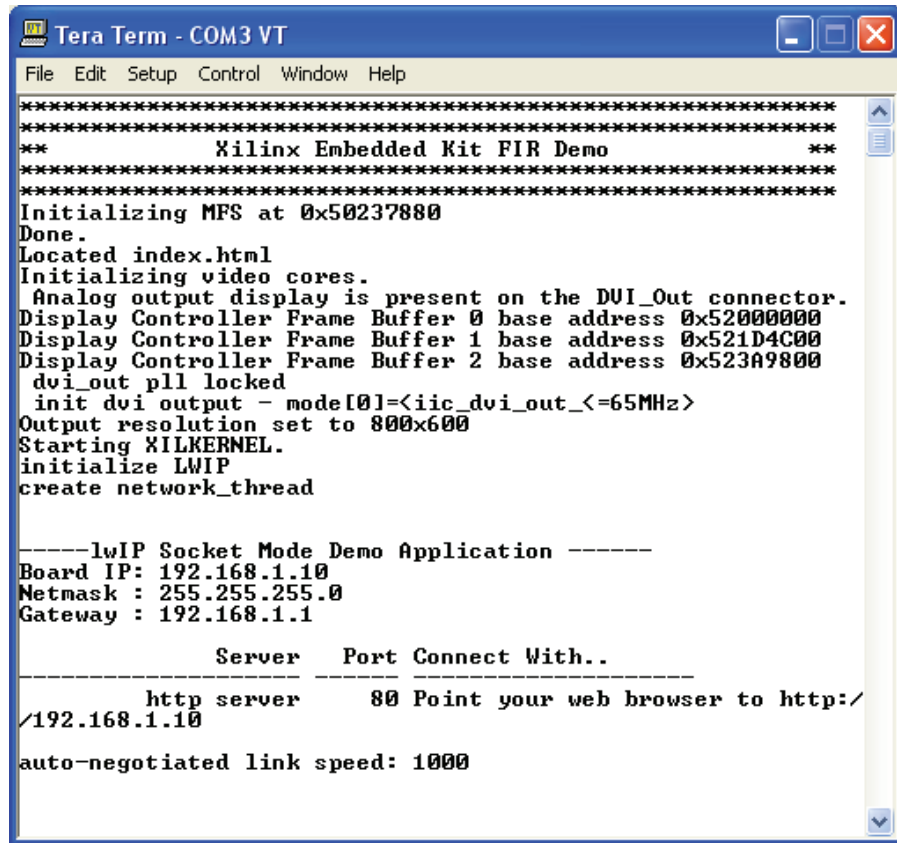

Figure 25: **SP605 SYSACE RESET Button**

12. After a lapse of 5 to 10 seconds, you should see the output shown in [Figure 26](#) on your serial communication window.



```

Tera Term - COM3 VT
File Edit Setup Control Window Help
*****
**                Xilinx Embedded Kit FIR Demo                **
*****
Initializing MFS at 0x50237880
Done.
Located index.html
Initializing video cores.
Analog output display is present on the DVI_Out connector.
Display Controller Frame Buffer 0 base address 0x52000000
Display Controller Frame Buffer 1 base address 0x521D4C00
Display Controller Frame Buffer 2 base address 0x523A9800
dvi_out pll locked
init dvi output - mode[0]=<iic_dvi_out_<=65MHz>
Output resolution set to 800x600
Starting XILKERNEL.
initialize LWIP
create network_thread

-----lwIP Socket Mode Demo Application -----
Board IP: 192.168.1.10
Netmask : 255.255.255.0
Gateway : 192.168.1.1

-----
Server      Port Connect With..
-----
http server      80 Point your web browser to http:/
/192.168.1.10

auto-negotiated link speed: 1000

```

UG727\_28\_111309

Figure 26: Serial Communication Window Output

**Congratulations!** You have now installed the Silicon Labs USB-UART Virtual COM Port (VCP) driver!

## Next Steps

Now that you have run through a FPGA-based Embedded Processor demo and installed the ISE Design Suite Embedded Edition, you are ready to create custom embedded systems for the Spartan-6 LX45T FPGA.

The following section provides pointers to various tutorials and reference designs that will help you become familiar with the Embedded Hardware and Software tools needed to customize MicroBlaze designs.

All material below can be found in the USB Stick provided with this Embedded Kit or under the Reference Designs section from the Spartan-6 Embedded Kit home page: <http://www.xilinx.com/s6embkit>

Figure 27 is a snapshot of the directory structure you will find in the SP605\_Embedded\_Kit folder on the USB stick included in the Embedded Kit or the zip file from the Embedded Kit web page. It is recommended that you copy the contents of the USB stick to a working area on your host computer.

**Caution!** Ensure that there are no spaces in the path name of the working area on your host computer.

The SP605\_Embedded\_Kit directories and their content are explained in Table 6.

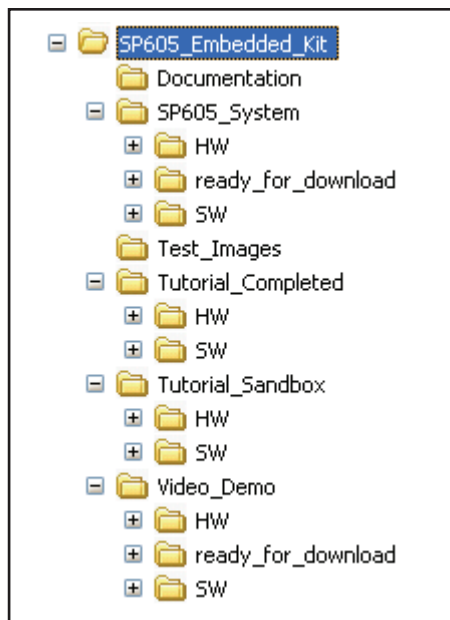

UG727\_29\_111309

Figure 27: SP605 Embedded Kit Directory Structure

Table 6: SP605 Embedded Kit Directory Structure Contents

Directory	Purpose
Documentation	Includes the data sheet, tutorials, and other supporting documentation provided with this Embedded Kit.
SP605_System	Base MicroBlaze Processor Subsystem including the software applications and platforms.
Test_Images	Images for testing the Video Demo.
Tutorial_Completed	Final state of files after the Hardware and Software Tutorials have been completed.
Tutorial Sandbox	Working directory to use for executing the Hardware and Software Tutorials. The tutorials start with the base MicroBlaze Processor Subsystem plus addition files needed to build the Video Demo. Perform the tutorials in this directory.
Video_Demo	Base MicroBlaze Processor Subsystem with the Video Pipeline cores. Source files for the video demo are included here.

## Data Sheet

### DS757 SP605 Embedded Kit MicroBlaze Processor Subsystem Data Sheet

- Documentation\  
ds757\_SP605\_MicroBlaze\_Processor\_SubSystem\_datasheet.pdf
- Detailed data sheet documentation of the MicroBlaze Processor Subsystem including block diagram, address map, pinout, FPGA design utilization and performance.

## Tutorials

### UG729 SP605 MicroBlaze Processor Subsystem Software Tutorial

- Documentation\ug729\_SP605\_software\_tutorial.pdf
- This tutorial will guide you through the steps to start software development using Xilinx SDK (Eclipse IDE) and the MicroBlaze Processor Subsystem.
- This will show you how to create stand-alone (no OS) programs from simple Hello World designs to a more complex Board Test program.
- This will also show you how to boot a Linux platform for the MicroBlaze Processor Subsystem and provide pointers to start Linux development.

### UG728 SP605 MicroBlaze Processor Subsystem Hardware Tutorial

- Documentation\ug728\_SP605\_hardware\_tutorial.pdf
- This tutorial will guide you through the steps to open the MicroBlaze Processor Subsystem using Platform Studio and add the Video Pipeline DSP blocks to recreate the out-of-the-box Embedded Kit demo.
- This will also show you how to add ChipScope debug cores to monitor your embedded system using the ChipScope Logic Analyzer.

## Reference Designs

### MicroBlaze Processor Subsystem

- SP605\_System
- This is the base MicroBlaze Processor Subsystem including the software applications and platforms.

### MicroBlaze Processor Subsystem with Video Pipeline Demo

- Video\_Demo
- This is the MicroBlaze Processor Subsystem with the Video Pipeline that was run as the power-on demo. Source files for the demo including the software application and platform are included here.



## Getting Help and Support

For questions regarding products within your Product Entitlement Account, send an e-mail message to your regional Customer Service Representative:

- Canada, USA and South America - [isscs\\_cases@xilinx.com](mailto:isscs_cases@xilinx.com)
- Europe, Middle East, and Africa - [eucases@xilinx.com](mailto:eucases@xilinx.com)
- Asia Pacific including Japan - [apaccase@xilinx.com](mailto:apaccase@xilinx.com)

For technical support including the installation and use of your product license file you may contact Xilinx Online Technical Support at [www.support.xilinx.com](http://www.support.xilinx.com). On this site you will also find the following resources for assistance:

- Software, IP and Documentation Updates
- Access to Technical Support Web Tools
- Searchable Answer Database with Over 4,000 Solutions
- User Forums
- Training - Select instructor-led classes and recorded e-learning options



## Warranty

---

THIS LIMITED WARRANTY applies solely to standard hardware development boards and standard hardware programming cables manufactured by or on behalf of Xilinx (“Development Systems”). Subject to the limitations herein, Xilinx warrants that Development Systems, when delivered by Xilinx or its authorized distributor, for ninety (90) days following the delivery date, will be free from defects in material and workmanship and will substantially conform to Xilinx publicly available specifications for such products in effect at the time of delivery. This limited warranty excludes: (i) engineering samples or beta versions of Development Systems (which are provided "AS-IS" without warranty); (ii) design defects or errors known as "errata"; (iii) Development Systems procured through unauthorized third parties; and (iv) Development Systems that have been subject to misuse, mishandling, accident, alteration, neglect, unauthorized repair or installation. Furthermore, this limited warranty shall not apply to the use of covered products in an application or environment that is not within Xilinx specifications or in the event of any act, error, neglect or default of Customer. For any breach by Xilinx of this limited warranty, the exclusive remedy of Customer and the sole liability of Xilinx shall be, at the option of Xilinx, to replace or repair the affected products, or to refund to Customer the price of the affected products. The availability of replacement products is subject to product discontinuation policies at Xilinx. Customer may not return product without first obtaining a customer return material authorization (RMA) number from Xilinx.

THE WARRANTIES SET FORTH HEREIN ARE EXCLUSIVE. XILINX DISCLAIMS ALL OTHER WARRANTIES, WHETHER EXPRESS, IMPLIED OR STATUTORY, INCLUDING, WITHOUT LIMITATION, ANY WARRANTY OF MERCHANTABILITY, FITNESS FOR A PARTICULAR PURPOSE, OR NON-INFRINGEMENT, AND ANY WARRANTY THAT MAY ARISE FROM COURSE OF DEALING, COURSE OF PERFORMANCE, OR USAGE OF TRADE. (2008.10)



Do not throw Xilinx products marked with the “crossed out wheeled bin” in the trash. Directive 2002/96/EC on waste electrical and electronic equipment (WEEE) requires the separate collection of WEEE. Your cooperation is essential in ensuring the proper management of WEEE and the protection of the environment and human health from potential effects arising from the presence of hazardous substances in WEEE. Return the marked products to Xilinx for proper disposal. Further information and instructions for free-of-charge return available at: <http://www.xilinx.com/ehs/weee.htm>.