



DimensionEngineering

SyRen 50 User's Guide
February 2011



**Single Channel 50A continuous/100A peak
Brushed motor controller**

Basic Information:

Input voltage: 6-30V nominal, 33.6V absolute max.

Output Current: Up to 50A continuous. Peak loads may be up to 100A for a few seconds. These ratings are for input voltages up to 30V in still air without any additional heatsinking.

Recommended power sources are:

- 5 to 24 cells NiMH or NiCd
- 2s to 8s lithium ion or lithium polymer. SyRen motor drivers have a lithium battery mode to prevent cell damage due to over-discharge of lithium battery packs.
- 6v to 30v lead acid
- 6v to 30v power supply (when in parallel with a suitable battery).

Dimensions:

- Size: 3.0" x 3.5" x 1.3" / 76.5mm x 89mm x 33mm
- Weight: 176g / 6.2oz

Features

Synchronous regenerative drive:

Going one step farther than just regenerative braking, a SyRen motor driver will return power to the battery any time a deceleration or motor reversal is commanded. This can lead to dramatic improvements in run time for systems that stop or reverse often, like a placement robot or a vehicle driving on hilly terrain. This drive scheme also saves power by returning the inductive energy stored in the motor windings to the battery each switching cycle, instead of burning it as heat in the motor windings. This makes part-throttle operation very efficient.

Ultra-sonic switching frequency:

SyRen 50 features a PWM frequency of 32kHz, which is well above the maximum frequency of human hearing. Unlike some other motor drivers, there is no annoying whine when the motor is on, even at low power levels.

Thermal and overcurrent protection:

SyRen 50 features dual temperature sensors and overcurrent sensing. It will protect itself from failure due to overheating, overloading and short circuits.

Easy mounting and setup:

SyRen has screw terminals for all inputs and outputs. There are four mounting holes, which accept 4-40 screws. Mounting hardware is included. All operating modes and options are set with DIP switches – there are no jumpers to struggle with or lose. No soldering is required.

Compact Size:

SyRen utilizes surface mount construction to provide the most power from a compact package. Its small size and light weight mean you have more space for cargo, batteries, or can make your robot smaller and more nimble than the competition.

Carefree reversing:

Unlike some other motor drivers, there is no need for the SyRen to stop before being commanded to reverse. You can go from full forward immediately to full reverse or vice versa. Braking and acceleration are proportional to the amount of reversal commanded, so gentle or rapid reversing is possible.

Many operating modes:

With analog, R/C and serial input modes, as well as dozens of operating options, the SyRen has the flexibility to be used over and over, even as your projects grow more sophisticated. Yet it is simple enough to use for your first project.

Sabertooth software compatibility: The SyRen 50 is compatible with the Sabertooth software available for Windows. This software suite can be used to control the SyRen50 from a PC using a packet serial interface.

Hooking up the SyRen motor driver

All connections to the SyRen are done with screw terminals. This makes it easy to set up and reconfigure your project. If you've never used screw terminal connections before, here is a quick overview.

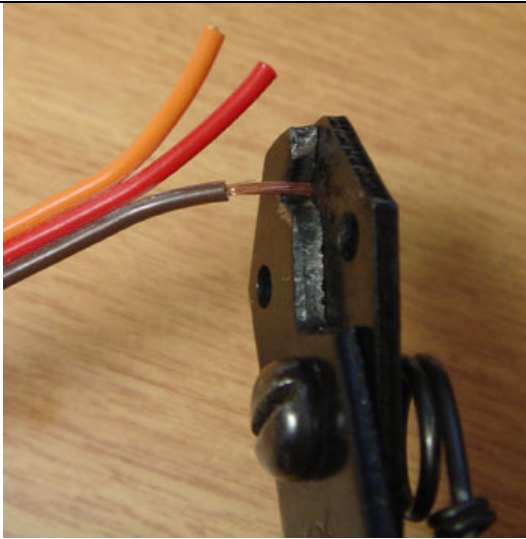

Step 1: Strip the wire which you are using approximately 1/4". The wires may be 14 gauge to 30 gauge

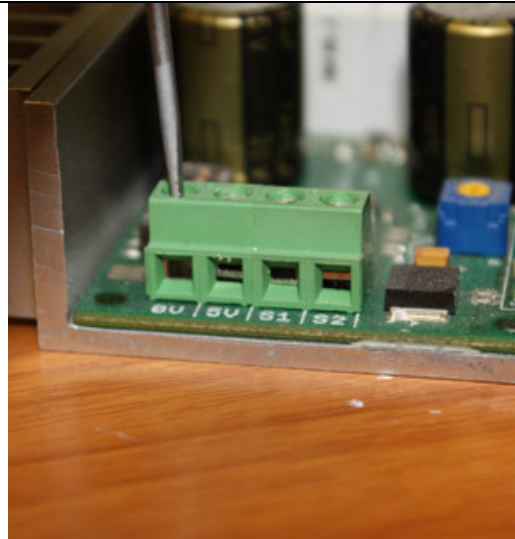

Step 2: With a small screwdriver, turn the top screw counter-clockwise until it stops gently.

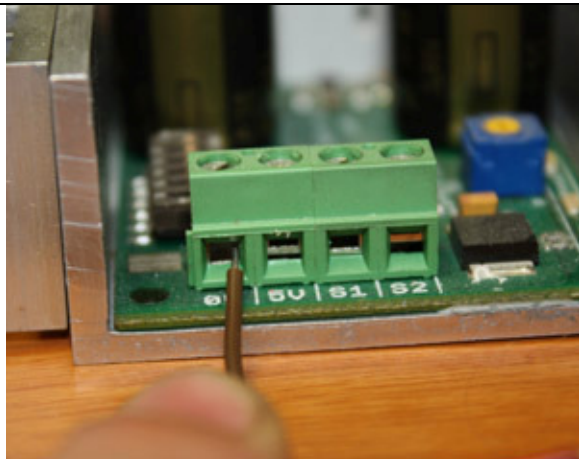

Step 3: Insert the stripped portion of the wire into the opening in the screw terminal

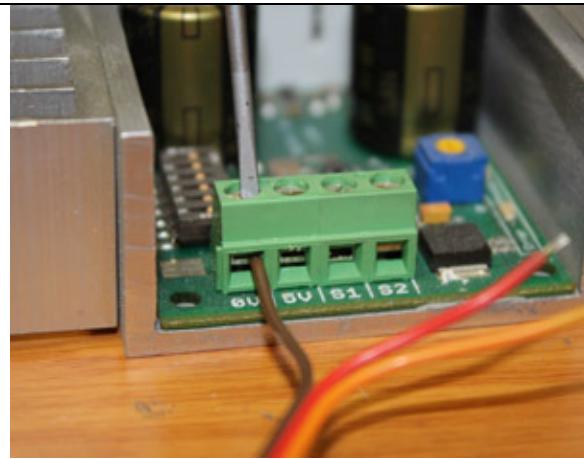

Step 4: Turn the top screw clockwise until you encounter resistance, then tighten the screw firmly. Pull on the wire gently to ensure that it is secured.

Motor Terminals M1 and M2

The motor is connected to terminals M1 and M2 as shown below. If the motor runs in the opposite way that you want, you may reverse the motor wires to reverse rotation.

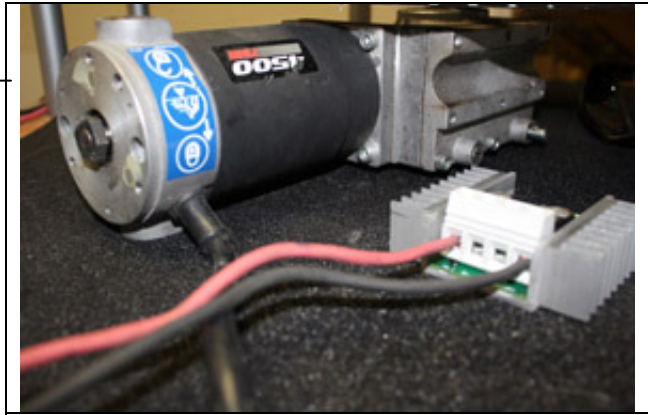

The motor connects to terminals M1 and M2

Signal Input Terminals S1 and S2

The input signals that control the SyRen are connected to terminals S1 and S2. S1 is the primary input, and must always be connected. S2 is the secondary input, and may or may not be connected, depending on which operating mode and options you have selected. If you are running in analog mode, it is important to have the signal wires to the motor driver connected before applying power to the device. Otherwise, the motor may start unexpectedly.

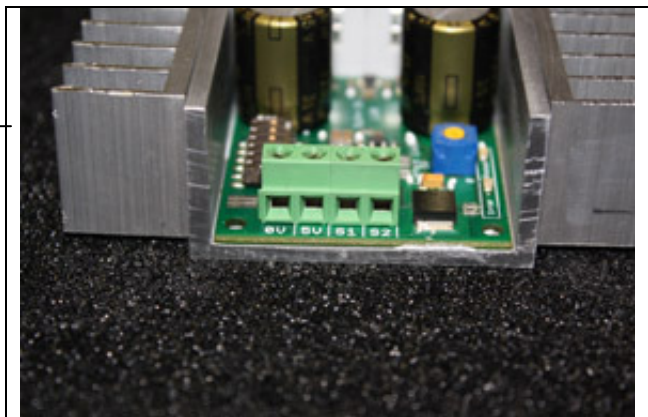

The input signal connects to terminal S1 and sometimes S2

Battery Terminals B+ and B-

The battery or power supply is connected to terminals B- and B+. B- connects to the negative side of the battery (usually black.) B+ connects to the positive side of the battery (usually red or yellow.) Often it is convenient to connect the battery through a connector instead of directly to the motor driver. This makes it easy to unplug the battery for charging, and prevents plugging in the battery backwards.

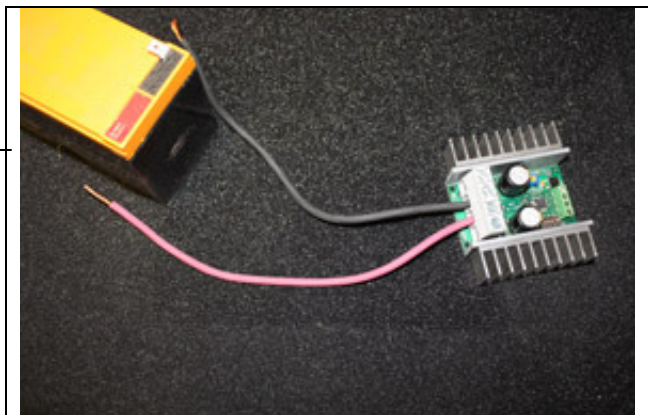

The battery connects to terminals B+ and B-

Warning! Be very careful to wire and plug in the battery and connector correctly. Connecting the battery backwards will destroy the SyRen and will void the warranty.

Power terminals 0V and 5V

The 0V and 5V connections are used to power and interface to low-power control circuits.

The 5V connection is a 5v power **output**. This is useful for supplying power to low-current devices, such as a potentiometer or a radio receiver. The 5v terminal is capable of supplying 100 milliamps if the source battery is 12.6v or less. If the source battery is greater than 12.6 volts, the 5v terminal is capable of supplying 10 milliamps. If more power is needed, we recommend using a ParkBEC or SW050 to supply the needed 5V power to the rest of the robot.

The 0V connection is the signal ground for the SyRen. In order to receive input signals correctly, it must be connected to the ground of the device sending the signals. 0V is internally connected to B-.

Using the 0V and 5v connections to power a radio receiver in R/C mode and potentiometer in analog mode is shown in Figures 2.1 and 2.2. If you are using multiple SyRens running from the same radio receiver, only one should have the 5v line connected.

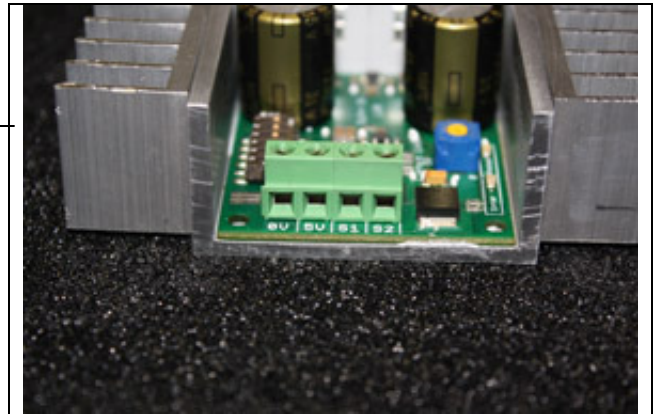

The 5V terminal can be used to power small loads, like a potentiometer or a radio receiver. The 0V signal must be connected to the ground of the device generating the input signal.

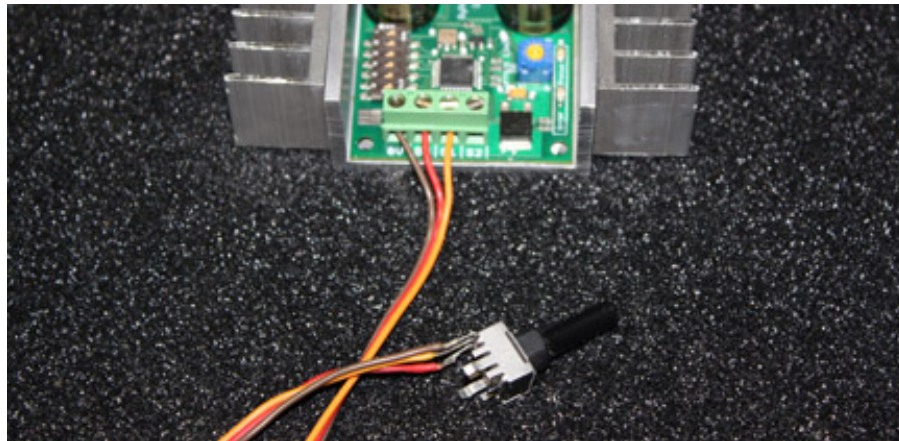

Figure 2.1: Analog input using a potentiometer powered from terminal 5V

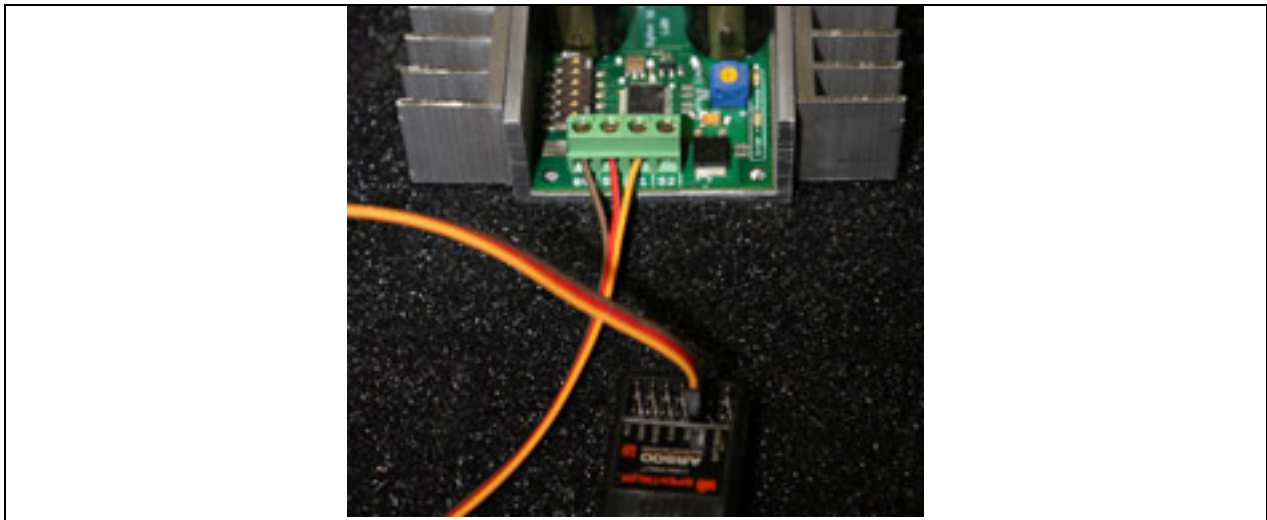
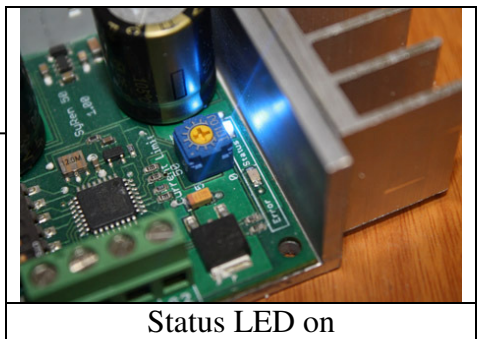

Figure 2.2: R/C input using a receiver powered from terminal 5V

Status and Error LEDs

The SyRen 50 has two indicator LEDs. The green LED marked status is used to communicate various information about the current state. Its operation depends on the operating mode. For example, if a lithium battery pack is selected, the status LED blinks the number of cells detected. Unless you are in lithium mode, the status LED will usually remain on.

The Error LED illuminates if the SyRen has detected a problem. It will light if the driver has shut down due to a depleted battery or due to overheating. If you are using a NiCd or NiMH battery, and commanding an acceleration causes the motor to jerk and the Error LED to flash on and off, the battery is depleted.



Status LED on

Mounting your SyRen

The SyRen is supplied with four mounting holes. These can be used to attach it to your robot. The centers of the mounting holes form a X" x X" rectangle. The holes are .125 inches in diameter. The proper size screw is a 4-40 round head machine or wood screw. Four 1" long machine screws and nuts are included.

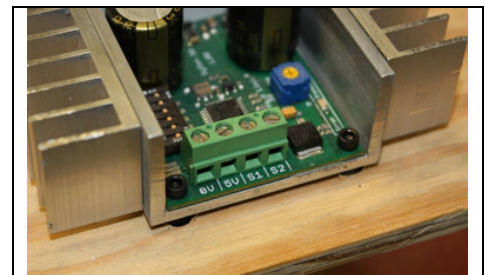

Figure 2.3: Mounted to a wood frame using standoffs

If your robot or device is constructed from insulating materials such as wood or plastic, it is advisable to use the four included plastic standoffs to allow air to circulate. This is shown in Figure 2.3

If your robot or device is constructed from metal, it is usually better to attach the SyRen directly to the frame, without standoffs. This will allow your frame to act as a heat sink and will cause the SyRen to run cooler. This is shown in Figure 2.4

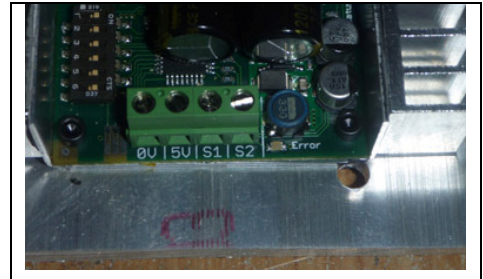

Figure 2.4: Mounted directly to a metal frame

Operating Modes Overview

Mode 1: Analog Input

Analog input mode takes one or two analog inputs and uses those to set the speed and direction of the motor. The valid input range is 0v to 5v. This makes the SyRen easy to control using a potentiometer, the PWM output of a microcontroller (with an R-C filter) or an analog circuit. Major uses include joystick or foot-pedal controlled vehicles, speed and direction control for pumps and machines and analog feedback loops. There is also a Diff-Drive mixing mode which takes two analog inputs for “tank style” steering.

Mode 2: R/C Input

R/C input mode takes one or two standard R/C channels and uses those to set the speed and direction of the motor. R/C mode can be set up as a single input driver for robots and vehicles that have steering wheels, as well as a 2-input mode for differential drive steering. This combines the ease of use of a dual motor driver with the flexibility of a single motor driver. There is an optional timeout setting. When timeout is enabled, the motor driver will shut down on loss of signal. This is for safety and to prevent the robot from running away should it encounter interference and should be used if a radio is being used to control the driver. If timeout is disabled, the motor driver will continue to drive at the commanded speed until another command is given. This makes the SyRen easy to interface to a Basic Stamp or other low-speed microcontrollers.

Mode 3: Simplified serial.

Simplified serial mode uses TTL level RS-232 serial data to set the speed and direction of the motor. This is used to interface the SyRen to a PC or microcontroller. If using a PC, a level converter such as a MAX232 chip must be used. The baud rate is set via DIP switches. Commands are single-byte, with 0 representing full reverse and 255 representing full forward. There is also a Slave Select mode which allows the use of multiple motors from a single microcontroller serial port.

Mode 4: Packetized serial

Packetized serial mode uses TTL level RS-232 serial data to set the speed and direction of the motor. There is a short packet format consisting of an address byte, a command byte, a data byte and a 7 bit checksum. SyRen 50 is set to 9600 baud from the factory. To change this, please navigate to the Packet serial section in this document and locate the commands page. Address bytes are set via dip switches. Up to 8 SyRen motor drivers may be ganged together on a single serial line. This makes packetized serial the preferred method to interface multiple SyRens to a PC or laptop.

Lithium cutoff:

Switch 3 of the DIP switch block selects lithium cutoff. If switch 3 is in the down position as shown the SyRen will automatically detect the number of series lithium cells at startup, and set a cutoff voltage of 3.0 volts per cell. The number of detected cells is flashed out on the Status LED.

If the number of cells detected is too low, your battery is in a severely discharged state and must be charged before operation. Failure to do so may cause damage to the battery pack. When 3.0V per cell is reached, the SyRen will shut down, preventing damage to the battery pack. This is necessary because a lithium battery pack discharged below 3.0v per cell will lose capacity and batteries discharged below 2.0v per cell may not recharge – ever.

Lithium cutoff mode may also be useful to increase the number of battery cycles you can get when running from a lead acid battery in non-critical applications. Because the system will continue to draw some power, even with the motor shut down, it is important to unplug the battery from the SyRen promptly once the cutoff is reached when using lithium batteries. If the SyRen is being run from NiCd, NiMH or alkaline batteries, or from a power supply, switch 3 should be in the up position.

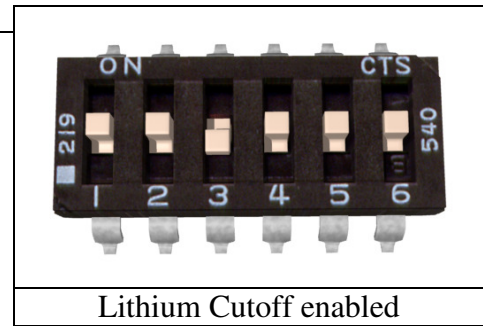

User-adjustable current limit:

The blue potentiometer on the board sets the current limit. The SyRen 50 can handle up to a 100A limit. There are many circumstance where you may need 50A, but do not want to let the system draw more than 60A or 70A. Some motors may have a rated stall current of 60A. You can set the SyRen 50's adjustable current limit to 50A and never put your motor in harm's way with a dangerous stall.

This option can be used to limit acceleration and starts with too much torque. It will basically act as an on-demand ramp that will only activate when you've reached the set limit. In some situations, long wire runs will prevent higher amount of current to be drawn due to heat. This option can reduce the amount of current being drawn and thusly reduce heat through the wire.

If you have an application where a vehicle could run into a wall, or an automatic door could pin someone or something, the adjustable current limit could be set to detect this and greatly reduce output to the motors.

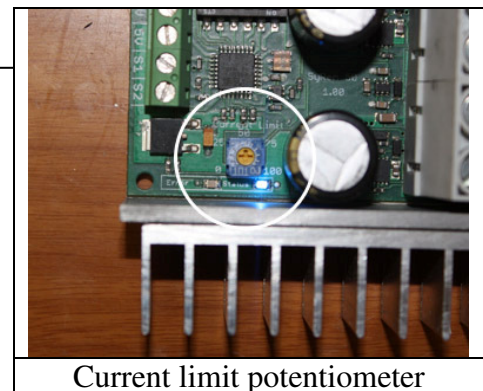

Mode 1: Analog Input

Analog input mode is selected by setting switches 1 and 2 to the UP position. Switch 3 should be either up or down, depending on the battery type being used. Inputs S1 and S2 are configured as analog inputs. The output impedance of the signals fed into the inputs should be less than 10k ohms for best results. If you are using a potentiometer to generate the input signals, a 1k, 5k or 10k linear taper pot is recommended. Remember to connect 0V to the ground of your control circuit.

There are 6 operating options for analog input. These are selected with switches 4 and 5.

Option 1: Analog Bi-direction

A signal of 2.5 volts corresponds to the motor being stopped. 0v corresponds to full power reverse, and 5v corresponds to full power forward mode. This is useful for direct bi-directional control of motors. There is one input, which is connected to S1.

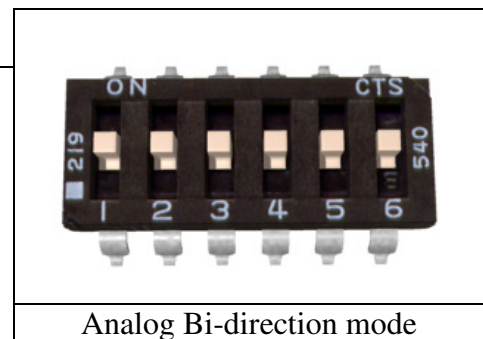

Option 2: Analog One-direction

A signal of 0v corresponds to the motor being fully stopped. 5v corresponds to full power forward. The motor acts single-direction only, and cannot be commanded to reverse. This is useful for fans, pumps, propellers and other single-direction only loads. There is one input, which is connected to S1

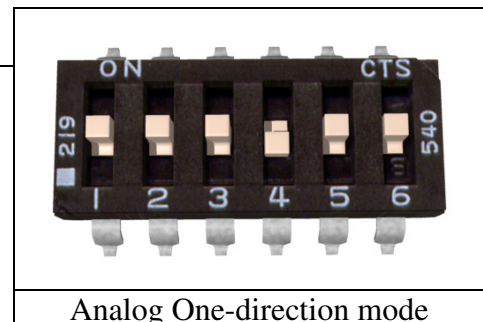

Option 3: Analog One-direction with forward/reverse select on S2

A signal on S1 of 0v corresponds to the motor being fully stopped. 5v corresponds to full power. A second signal is fed to S2. If the signal on S2 is greater than 2.5 volts, the SyRen will drive the motor forward. If the signal on S2 is less than 2.5 volts, the SyRen will drive the motor backwards. The signal on S2 can be either an analog signal or a digital signal. This is useful for oscillating loads that go back and forth at a preset speed, as well as vehicles with a reverse selector switch.

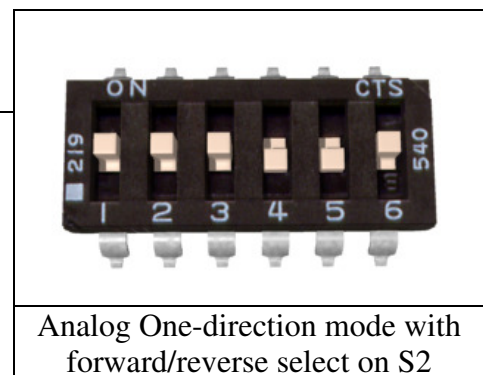

Option 4: Max Speed – Single Direction

This option is set by flipping switch 5 OFF, or down, and flipping switch 6 ON, or up. Max Speed Mode allows you to connect another potentiometer to S2 and set the max speed. If you set this potentiometer to 50%, the potentiometer on S1 will scale between 0% and 50% over the entire length of its travel. This mode is very useful if you are, for example, running off of 24V and want to limit the top speed somewhere around 14V.

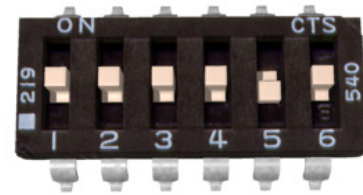

Max Speed Mode –
Single Direction

Option 5: Max Speed – Bi-directional

This option is set by flipping switches 5 and 6 OFF, or down. Max Speed Mode allows you to connect another potentiometer to S2 and set the max speed. This potentiometer will set the maximum speed of both directions. This is very useful for limiting the top speed without having to lower the input voltage.

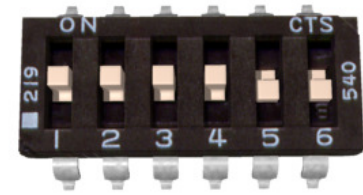

Max Speed Mode –
Bi-directional

Option 6: Analog motor reverse

Switch 6 reverses the direction of the motor driver in all analog operating modes except Diff-Drive Mix, in which case it is the right/left select switch. This is sometimes better than physically reversing the motor connections, but accomplishes the same thing.

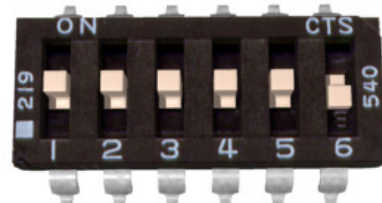

Analog One-direction reverse

Note on using filtered PWM in Analog Mode

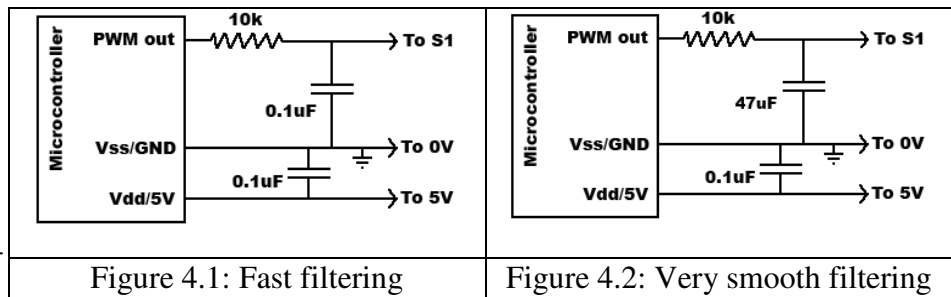

If you are using a filtered PWM signal from a microcontroller to generate the analog voltage, an R-C filter with component values 10k ohms and at least .1uf is recommended as shown in Figure 4.1. This will provide a fast response to changes in duty cycle, and is suitable for PWM rates of 20+kHz. Using a larger value filter capacitor such as 47uf (Figure 4.2) will result in smoother motor operation and greater efficiency. However, the transient response will be slower. This extra capacitance is strongly recommended when using slower PWM frequencies – as low as 1kHz. Tweaking the value of the capacitor to suit your individual needs is safe way to optimize your robot's performance.

Mode 2: R/C Input

R/C input mode is used with a standard hobby Radio control transmitter and receiver, or a microcontroller using the same protocol. R/C mode is selected by setting switch 1 to the DOWN position and switch 2 to the UP position. If running from a receiver, it is necessary to obtain one or more servo pigtails and hook them up according to figure 5.1. If there are only motor drivers being used it is acceptable to power the receiver directly from a SyRen as shown. If the system also has to power servos or other 5v loads, we recommend a ParkBEC or a receiver battery pack, as shown in figure 5.2. If using a receiver pack, do not connect power to the 5V line of the SyRen because the maximum voltage it can tolerate is 6V.

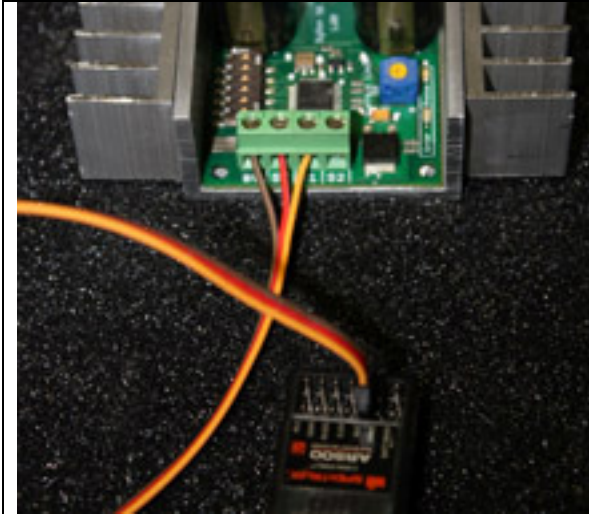

Figure 5.1: R/C connection

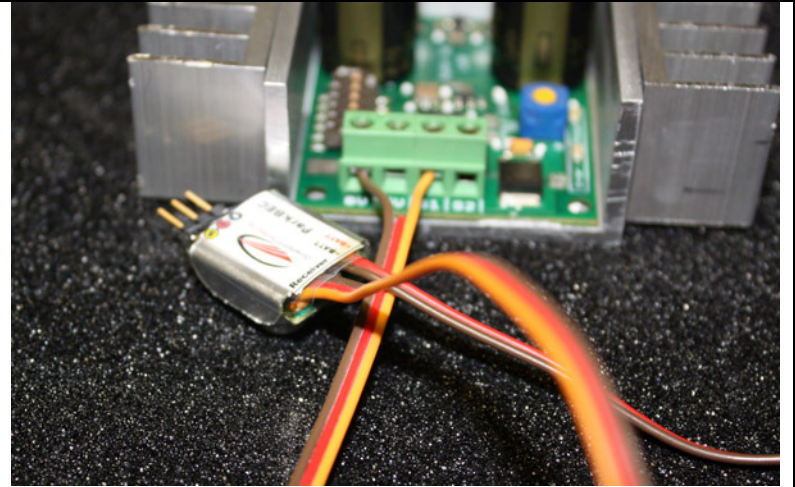
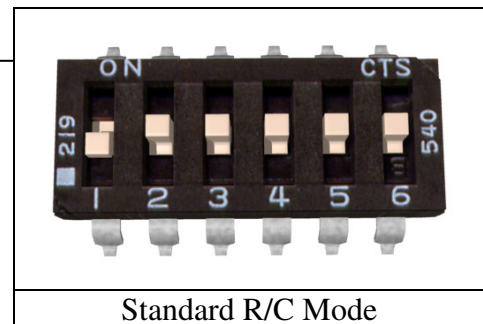

Figure 5.2: R/C with a ParkBEC

There are two operating modes for R/C. These are selected with switch 5.

Option 1: Standard R/C mode

A standard R/C pulse is fed into S1. A 1500us pulse is zero speed, a 1000 us pulse is full reverse and a 2000 us pulse is full forward. Because different transmitter manufacturers use different default pulse widths, if it seems like you are not getting full power, it may be necessary to increase the transmitter's ATV to 120%.



Standard R/C Mode

Option 2: R/C Auto-Calibrate Mode

R/C Auto-Calibrate mode is used to interface to R/C systems that do not use 1500us as their center point. Examples are pistol-style transmitters with a “70/30” throttle and airplane style throttles where a single-direction control is desired. In R/C auto-calibrate mode, the position the control stick is when the driver is powered up is taken as the neutral point. During operation, the driver will detect the minimum and maximum control inputs, and use those to set the control range. If the driver is initialized with the control stick at either extreme, the driver will operate in single-direction mode.

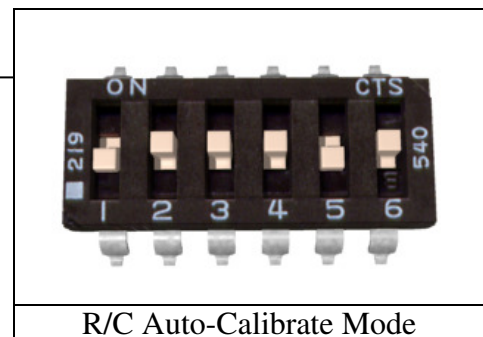

R/C Auto-Calibrate Mode

Switch 6: R/C Failsafe Timeout

In all the R/C modes, if switch 6 is set to the UP position, then Timeout Failsafe mode is active. This will bring the motor to a stop if the servo signal is interrupted. Once several valid control signals are sent, the motor will restart. This is useful to prevent a robot driving away if it encounters interference, drives out of range, or if the transmitter is inadvertently de-activated. Many robot competitions require this feature.

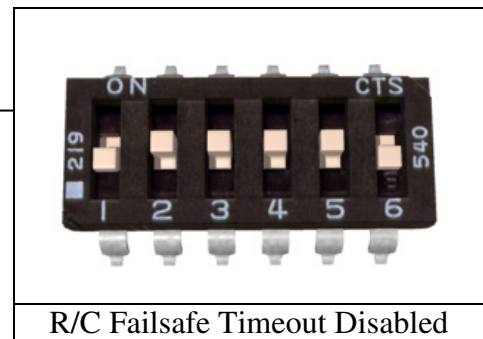

If switch 6 is set in the DOWN position, then Timeout Failsafe mode is de-activated. This means that the SyRen will continue to drive the motor according to the last command until another command is given. If the control link is possible unreliable – like a radio - then this can be dangerous due to the robot not stopping. However, it is extremely convenient if you are controlling the SyRen from a microcontroller. In this case, commanding the controller can be done with as little as three lines of code.

```
Output_High(Pin connected to S1)
Delay(1000us to 2000us)
Output_Low(Pin connected to S1)
```

This makes it easy to use R/C mode without having to set up a repeating pulse stream. This is most advantageous on controllers like Basic Stamps, which don't have the ability to perform background tasks.

A note on certain microprocessor receivers

Some receivers, such as the Spektrum AR6000, will output servo pulses before a valid transmitter signal is present. This will cause the SyRen to autocalibrate to the receiver's startup position which may not correspond to the center stick position, depending on trim settings. This may cause the motors to move slowly, even when the transmitter stick is centered. If you encounter this, either consult your receiver manual to reprogram the startup position, or adjust your transmitter trims until the motors stop moving. As a last resort, you can enter R/C microcontroller mode which will disable SyRen's autocalibration.

Mode 3: Simplified Serial Mode

Simplified serial uses TTL level single-byte serial commands to set the motor speed and direction. This makes it easy to interface to microcontrollers and PCs, without having to implement a packet-based communications protocol. Simplified serial is a one-direction only interface. The transmit line from the host is connected to S1. The host's receive line is not connected to the SyRen. Because of this, multiple drivers can be connected to the same serial transmitter. If using a true RS-232 device like a PC's serial port, it is necessary to use a level converter to shift the -10V to 10V rs-232 levels to the 0v-5v TTL levels the SyRen is expecting. This is usually done with a Max232 type chip. If using a TTL serial device like a microcontroller, the TX line of the microcontroller may be connected directly to S1.

Baud Rate Selection

Simplified Serial operates with an 8N1 protocol – 8 data bytes, no parity bits and one stop bit. The baud rate is selected by switches 4 and 5 from the following 4 options

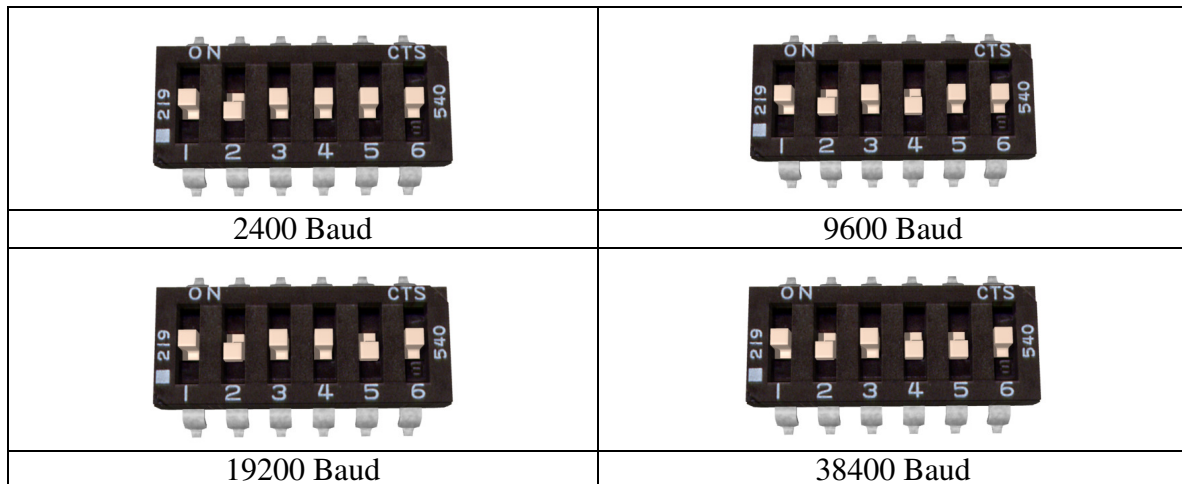

What baud rate to use is dependent on what your host can provide and the update speed necessary. 9600 baud or 19200 baud are recommended as the best starting points. If communication is unreliable, decrease the baud rate. If communications are reliable, you may increase the baud rate. The maximum update speed on the SyRen 50 is approximately 2000 commands per second. Sending characters faster than this will not cause problems, but it will not increase the responsiveness of the controller either.

The baud rate may be changed with power on by changing the DIP switch settings. There is no need to reset or cycle power after a baud rate change.

There are 2 operating options for Simplified Serial. These are selected by the position of Switch 6.

Mode 4: Packetized Serial Mode

Packetized Serial uses TTL level multi-byte serial commands to set the motor speed and direction. Packetized serial is a one-direction only interface. The transmit line from the host is connected to S1. The host's receive line is not connected to the SyRen 50. Because of this, multiple SyRens can be connected to the same serial transmitter. If using a true RS-232 device like a PC's serial port, it is necessary to use a level converter to shift the -10V to 10V rs-232 levels to the 0v-5v TTL. Packetized serial uses an address byte to select the target device. The baud rate is **set to 9600 baud from the factory**. To change the baud rate, see the list of serial commands later in this section.

Packet Overview

The packet format for the SyRen 50 consists of an address byte, a command byte, a data byte and a seven bit checksum. Address bytes have value greater than 128, and all subsequent bytes have values 127 or lower. This allows multiple types of devices to share the same serial line.

An example packet and pseudo-code to generate it are shown in **Figures 7.1 and 7.2**

<u>Packet</u> Address: 130 Command : 0 Data: 64 Checksum: 66	<pre>Void DriveForward(char address, char speed) { Putc(address); Putc(0); Putc(speed); Putc((address + 0 + speed) & 0b01111111); }</pre>
Figure 7.1: Example 50% forward	Figure 7.2: Pseudocode to generate 7.1

Baud Rate Selection:

Packetized Serial operates with an 8N1 protocol – 8 data bytes, no parity bits and one stop bit. The baud rate is automatically calculated by the first character sent. This character must be 170 (binary 10101010) and must be sent before any serial communications are done. It is not possible to change the baud rate once the bauding character has been sent. The valid baud rates are 2400, 9600, 19200 and 38400 baud. Until the bauding character is sent, the driver will accept no commands and the green status light will stay lit. Please note that the SyRen 50 may take up to a second to start up after power is applied, depending on the power source being used. Sending the bauding character during this time period may cause undesirable results. **When using Packetized Serial mode, please allow a two second delay between applying power and sending the bauding character to the drivers.**

Address Byte Configuration:

Address bytes are set by switches 4, 5 and 6. Addresses start at 128 and go to 135. The switch settings for the addresses are shown in the chart below

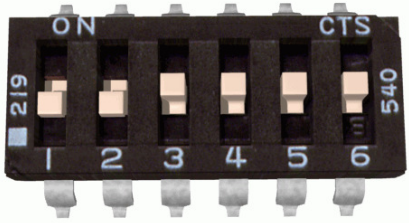
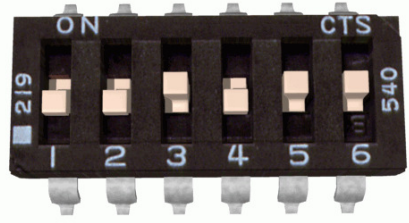
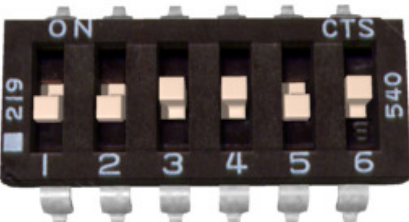
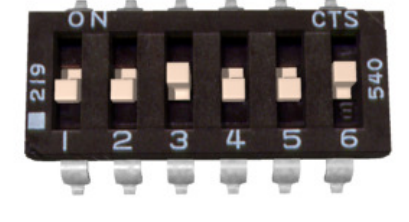
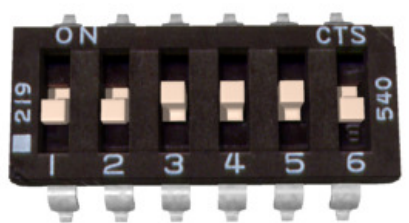
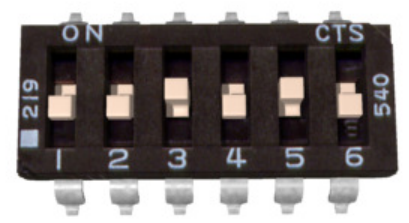
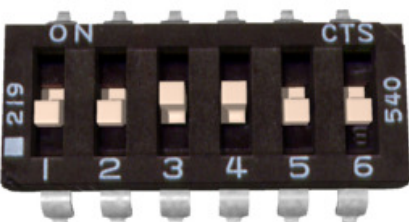
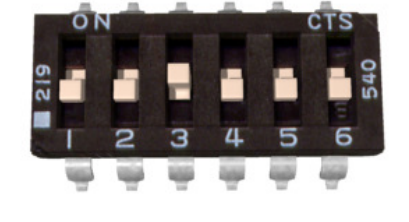
 A 6-pin DIP switch assembly with pins labeled 1 through 6. The top of the assembly has 'ON' on the left and 'CTS' on the right. A blue tab labeled '219' is on the left and '540' is on the right. For Address 128, switches 1, 2, 3, and 4 are in the 'ON' position, while switches 5 and 6 are in the 'OFF' position.	 A 6-pin DIP switch assembly with pins labeled 1 through 6. The top of the assembly has 'ON' on the left and 'CTS' on the right. A blue tab labeled '219' is on the left and '540' is on the right. For Address 129, switches 1, 2, 3, and 5 are in the 'ON' position, while switches 4 and 6 are in the 'OFF' position.
Address: 128	Address: 129
 A 6-pin DIP switch assembly with pins labeled 1 through 6. The top of the assembly has 'ON' on the left and 'CTS' on the right. A blue tab labeled '219' is on the left and '540' is on the right. For Address 130, switches 1, 2, 3, and 5 are in the 'ON' position, while switches 4 and 6 are in the 'OFF' position.	 A 6-pin DIP switch assembly with pins labeled 1 through 6. The top of the assembly has 'ON' on the left and 'CTS' on the right. A blue tab labeled '219' is on the left and '540' is on the right. For Address 131, switches 1, 2, 3, and 6 are in the 'ON' position, while switches 4 and 5 are in the 'OFF' position.
Address: 130	Address: 131
 A 6-pin DIP switch assembly with pins labeled 1 through 6. The top of the assembly has 'ON' on the left and 'CTS' on the right. A blue tab labeled '219' is on the left and '540' is on the right. For Address 132, switches 1, 2, 3, and 6 are in the 'ON' position, while switches 4 and 5 are in the 'OFF' position.	 A 6-pin DIP switch assembly with pins labeled 1 through 6. The top of the assembly has 'ON' on the left and 'CTS' on the right. A blue tab labeled '219' is on the left and '540' is on the right. For Address 133, switches 1, 2, 3, and 5 are in the 'ON' position, while switches 4 and 6 are in the 'OFF' position.
Address: 132	Address: 133
 A 6-pin DIP switch assembly with pins labeled 1 through 6. The top of the assembly has 'ON' on the left and 'CTS' on the right. A blue tab labeled '219' is on the left and '540' is on the right. For Address 134, switches 1, 2, 3, and 5 are in the 'ON' position, while switches 4 and 6 are in the 'OFF' position.	 A 6-pin DIP switch assembly with pins labeled 1 through 6. The top of the assembly has 'ON' on the left and 'CTS' on the right. A blue tab labeled '219' is on the left and '540' is on the right. For Address 135, switches 1, 2, 3, and 6 are in the 'ON' position, while switches 4 and 5 are in the 'OFF' position.
Address: 134	Address: 135

Commands:

The command byte is the second byte of the packet. There are four possible commands in packetized serial mode. Each is followed by one byte of data

0: Drive forward (decimal 0, binary 0b00000000, hex 0h00)

This is used to command the SyRen 10 and 20 to drive forward. Valid data is 0-127 for off to full forward drive. If a command of 0 is given, the SyRen will go into power save mode after approximately 4 seconds.

1: Drive backwards (decimal 1, binary 0b00000001, hex 0h01)

This is used to command the SyRen 10 and 20 to drive forward. Valid data is 0-127 for off to full reverse drive. If a command of 0 is given, the SyRen will go into power save mode after approximately 4 seconds.

2: Min voltage (decimal 3, binary 0b00000011, hex 0h03)

This is used to set a custom minimum voltage for the battery feeding the SyRen 50. If the battery voltage drops below this value, the output will shut down. This value is cleared at startup, so much be set each run. The value is sent in .2 volt increments with a command of zero corresponding to 6v, which is the minimum. Valid data is from 0 to 120. The function for converting volts to command data is

$$\text{Value} = (\text{desired volts}-6) \times 5$$

3: Max voltage (decimal 4, binary 0b00000100, hex 0h04)

This is used to set a custom maximum voltage. If you are using a power supply that cannot sink current such as an ATX supply, the input voltage will rise when the driver is regenerating (slowing down the motor) Many ATX type supplies will shut down if the output voltage on the 12v supply rises beyond 16v. If the driver detects an input voltage above the set limit, it will put the motor into a hard brake until the voltage drops below the set point again. This is inefficient, because the energy is heating the motor instead of recharging a battery, but may be necessary. The driver comes preset for a maximum voltage of 30V. The range for a custom maximum voltage is 0v-25v. The formula for setting a custom maximum voltage is

$$\text{Value} = \text{Desired Volts} \times 5.12$$

If you are using any sort of battery, then this is not a problem and the max voltage should be left at the startup default.