

**SURFACE MOUNT SCHOTTKY BARRIER RECTIFIER**

**VOLTAGE RANGE 20 to 200 Volts CURRENT 1.0 Ampere**

**FEATURES**

- \* Metal silicon junction, majority carrier conduction
- \* For surface mounted applications
- \* Low power loss, high efficiency
- \* High forward surge current capability
- \* High surge capability
- \* High reliability

**MECHANICAL DATA**


- \* Case: Molded plastic
- \* Epoxy: Device has UL flammability classification 94V-O
- \* Lead: MIL-STD-202E method 208C guaranteed
- \* Mounting position: Any

**MAXIMUM RATINGS AND ELECTRICAL CHARACTERISTICS**

Ratings at 25 °C ambient temperature unless otherwise specified.  
Resistive or inductive load.

**PINNING**

PIN	DESCRIPTION
1	Cathode
2	Anode



Top View  
Marking Code: DS12W ---S12  
DS14W ---S14  
DS16W ---S16  
DS18W ---S18  
DS110W ---S110  
DS112W ---S112  
DS115W ---S115  
DS120W ---S120

Weight: 17mg, 0.0006 oz  
Simplified outline SOD-123F(L) and symbol

**MAXIMUM RATINGS (@ TA=25 °C unless otherwise noted)**

RATINGS	SYMBOL	DS12W	DS14W	DS16W	DS18W	DS110W	DS112W	DS115W	DS120W	UNITS
Maximum Recurrent Peak Reverse Voltage	V <sub>RRM</sub>	20	40	60	80	100	120	150	200	Volts
Maximum RMS Voltage	V <sub>RMS</sub>	14	28	42	56	70	84	105	140	Volts
Maximum DC Blocking Voltage	V <sub>DC</sub>	20	40	60	80	100	120	150	200	Volts
Maximum Average Forward Rectified Current	I <sub>O</sub>	1.0								Amps
Peak Forward Surge Current 8.3 ms single half sine-wave superimposed on rated load (JEDEC method)	I <sub>FSM</sub>	40								Amps
Typical Current Square Time	I <sup>2</sup> T	6.64								A <sup>2</sup> S
Typical Thermal Resistance (Note 1)	R <sub>θJA</sub>	115								°C/W
Typical Junction Capacitance (Note 2)	C <sub>J</sub>	110				80				pF
Operating Temperature Range	T <sub>J</sub>	-55 to + 150								°C
Storage Temperature Range	T <sub>STG</sub>	-55 to + 150								°C

**ELECTRICAL CHARACTERISTICS(@TA=25 °C unless otherwise noted)**

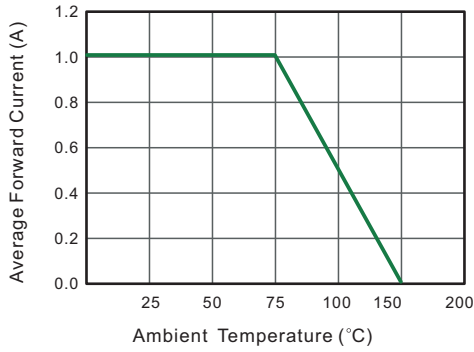
CHARACTERISTICS	SYMBOL	DS12W	DS14W	DS16W	DS18W	DS110W	DS112W	DS115W	DS120W	UNITS
Maximum Instantaneous Forward Voltage at 1.0A DC	V <sub>F</sub>	.55		.70		.85				Volts
Maximum Average Reverse Current at Rated DC Blocking Voltage	@T <sub>A</sub> = 25°C	0.3				0.2		0.1		mA
	@T <sub>A</sub> = 150°C	20				10		5		mA

NOTES : 1. Thermal Resistance : Mounted on PCB.  
2. Measured at 1 MHz and applied reverse voltage of 4.0 volts.

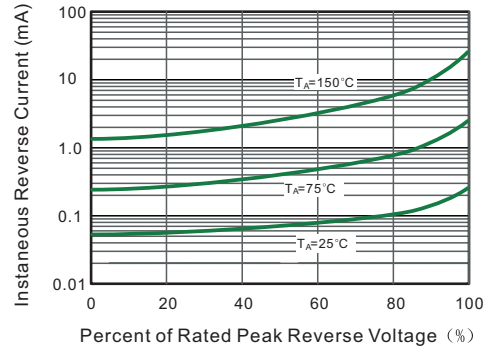
2020-11/01  
REV:C

# RATING AND CHARACTERISTICS CURVES (DS12W THRU DS120W)

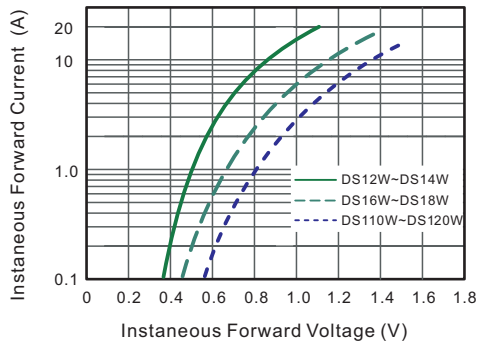
**Fig.1 Forward Current Derating Curve**



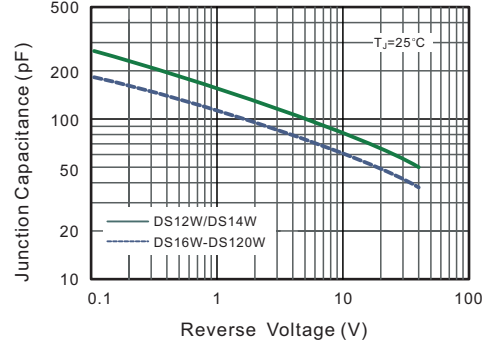
**Fig.2 Typical Reverse Characteristics**



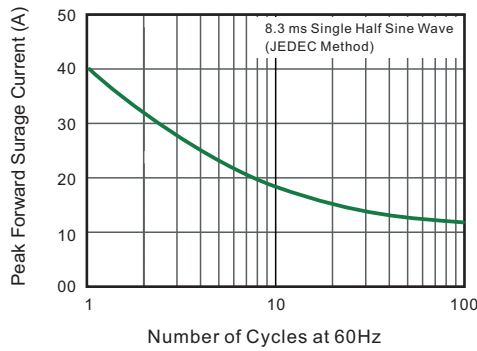
**Fig.3 Typical Forward Characteristic**



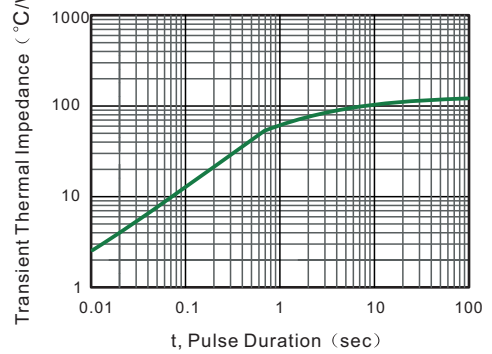
**Fig.4 Typical Junction Capacitance**



**Fig.5 Maximum Non-Repetitive Peak Forward Surge Current**

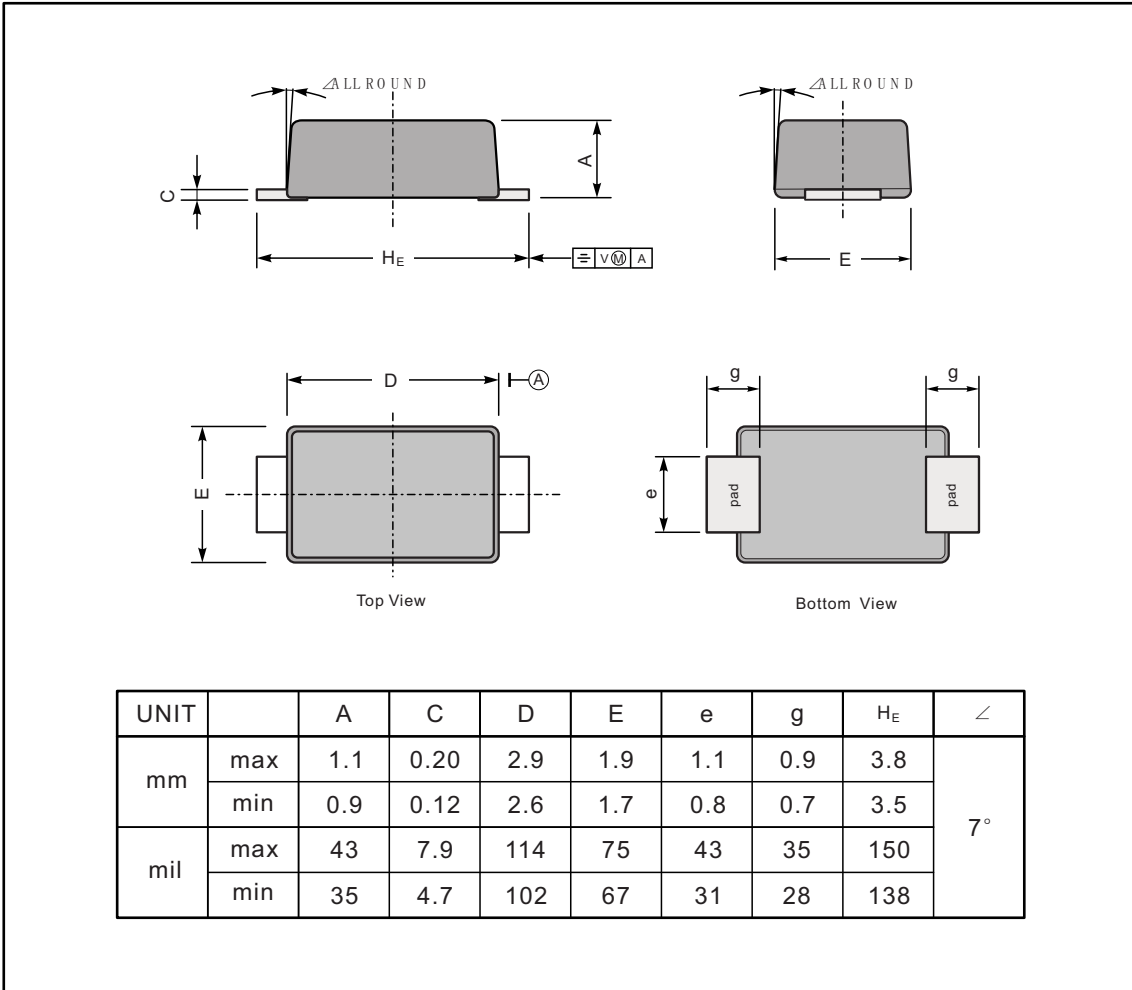


**Fig.6- Typical Transient Thermal Impedance**

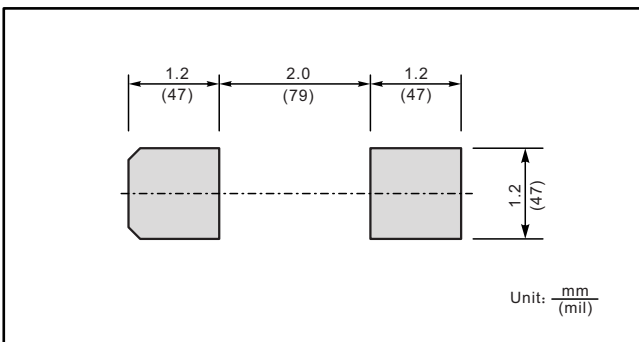


# PACKAGE OUTLINE

## Plastic surface mounted package; 2 leads



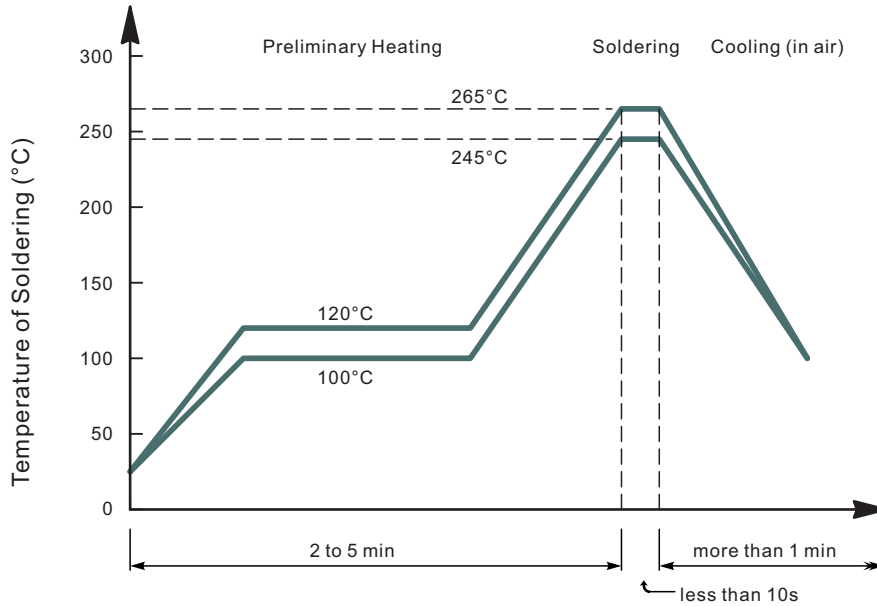
### The recommended mounting pad size



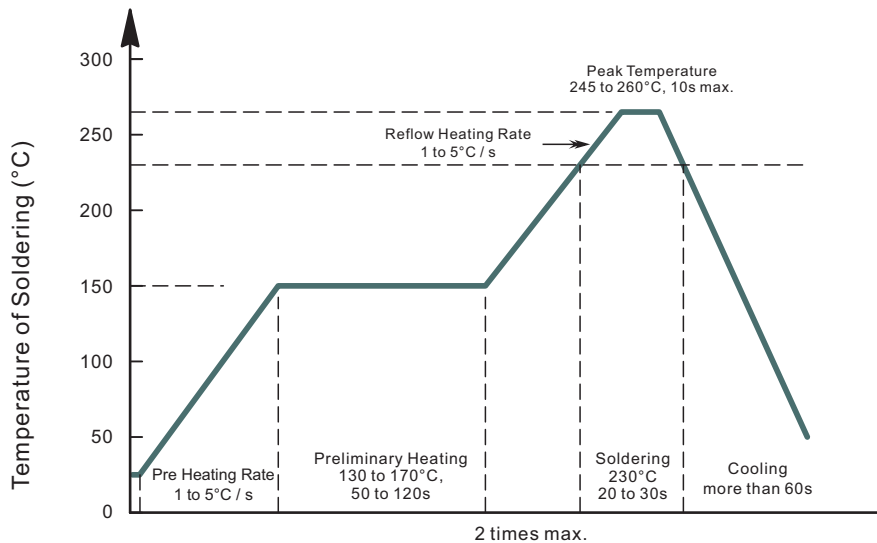
### Marking

Type number	Marking code
DS12W	S12
DS14W	S14
DS16W	S16
DS18W	S18
DS110W	S110
DS112W	S112
DS115W	S115
DS120W	S120

• Recommended condition of flow soldering



• Recommended condition of reflow soldering



Recommended peak temperature is over 245 °C. If peak temperature is below 245 °C, you may adjust the following parameters; time length of peak temperature (longer), time length of soldering (longer), thickness of solder paste (thicker)

• Condition of hand soldering

Temperature: 350°C  
 Time: 3s max.  
 Times: one time

• Remark:

Lead free solder paste (96.5Sn/3.0Ag/0.5Cu)

## PACKAGING OF DIODE AND BRIDGE RECTIFIERS

### REEL PACK

PACKAGE	PACKING CODE	EA PER REEL	EA PER INNER BOX	COMPONENT SPACE (mm)	TAPE SPACE (mm)	REEL DIA (mm)	CARTON SIZE (mm)	EA PER CARTON	GROSS WEIGHT(Kg)
SOD-123F(L)	-W/T	3,000	15,000	---	---	178	390*205*310	120,000	6.964