

SURFACE MOUNT SCHOTTKY BARRIER RECTIFIER

VOLTAGE RANGE 20 to 200 Volts CURRENT 1.0 Ampere

FEATURES

- * Metal silicon junction, majority carrier conduction
- * For surface mounted applications
- * Low power loss, high efficiency
- * High forward surge current capability
- * High surge capability
- * High reliability

MECHANICAL DATA

- * Case: Molded plastic
- * Epoxy: Device has UL flammability classification 94V-O
- * Lead: MIL-STD-202E method 208C guaranteed
- * Mounting position: Any

MAXIMUM RATINGS AND ELECTRICAL CHARACTERISTICS

Ratings at 25 °C ambient temperature unless otherwise specified.
Resistive or inductive load.

PINNING

PIN	DESCRIPTION
1	Cathode
2	Anode

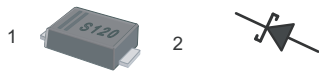

Top View
Marking Code: DS12W ---S12
DS14W ---S14
DS16W ---S16
DS18W ---S18
DS110W ---S110
DS112W ---S112
DS115W ---S115
DS120W ---S120

Weight: 17mg, 0.0006 oz
Simplified outline SOD-123F(L) and symbol

MAXIMUM RATINGS (@ TA=25 °C unless otherwise noted)

RATINGS	SYMBOL	DS12W	DS14W	DS16W	DS18W	DS110W	DS112W	DS115W	DS120W	UNITS
Maximum Recurrent Peak Reverse Voltage	V _{RRM}	20	40	60	80	100	120	150	200	Volts
Maximum RMS Voltage	V _{RMS}	14	28	42	56	70	84	105	140	Volts
Maximum DC Blocking Voltage	V _{DC}	20	40	60	80	100	120	150	200	Volts
Maximum Average Forward Rectified Current	I _O	1.0								Amps
Peak Forward Surge Current 8.3 ms single half sine-wave superimposed on rated load (JEDEC method)	I _{FSM}	40								Amps
Typical Current Square Time	I ² T	6.64								A ² S
Typical Thermal Resistance (Note 1)	R _{θJA}	115								°C/W
Typical Junction Capacitance (Note 2)	C _J	110				80				pF
Operating Temperature Range	T _J	-55 to + 150								°C
Storage Temperature Range	T _{STG}	-55 to + 150								°C

ELECTRICAL CHARACTERISTICS(@TA=25 °C unless otherwise noted)

CHARACTERISTICS	SYMBOL	DS12W	DS14W	DS16W	DS18W	DS110W	DS112W	DS115W	DS120W	UNITS
Maximum Instantaneous Forward Voltage at 1.0A DC	V _F	.55		.70		.85				Volts
Maximum Average Reverse Current at Rated DC Blocking Voltage	@T _A = 25°C	0.3				0.2		0.1		mA
	@T _A = 150°C	20				10		5		mA

NOTES : 1. Thermal Resistance : Mounted on PCB.
2. Measured at 1 MHz and applied reverse voltage of 4.0 volts.

2020-11/01
REV:C

RATING AND CHARACTERISTICS CURVES (DS12W THRU DS120W)

Fig.1 Forward Current Derating Curve

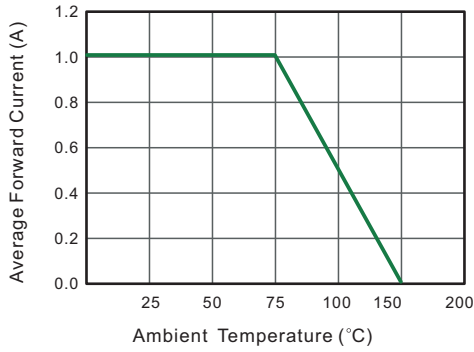

Fig.2 Typical Reverse Characteristics

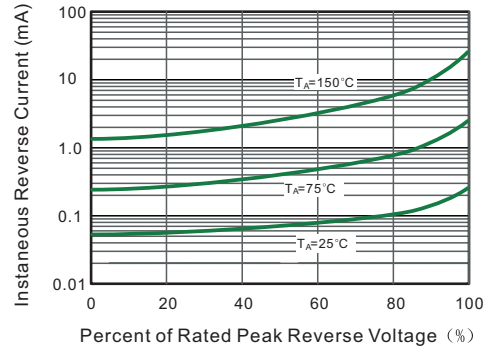

Fig.3 Typical Forward Characteristic

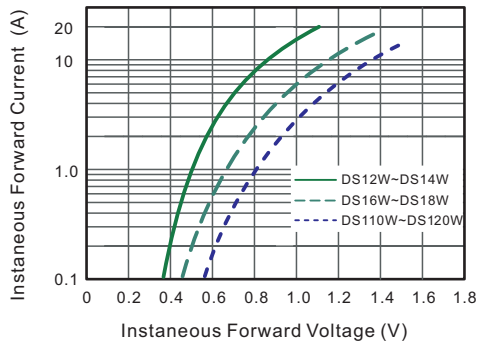

Fig.4 Typical Junction Capacitance

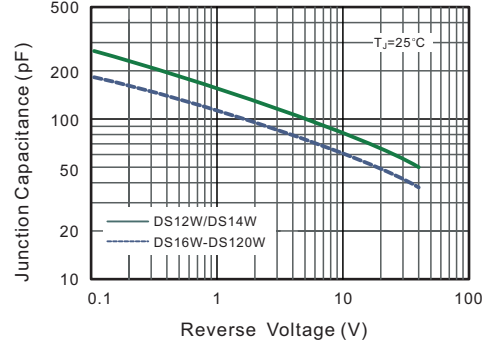

Fig.5 Maximum Non-Repetitive Peak Forward Surge Current

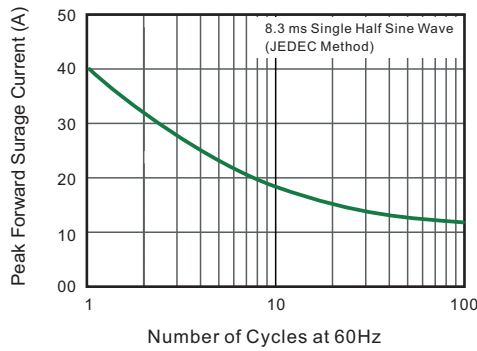
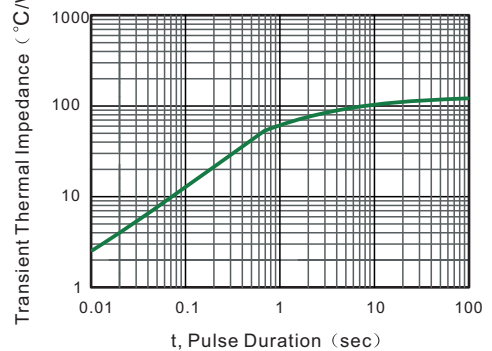
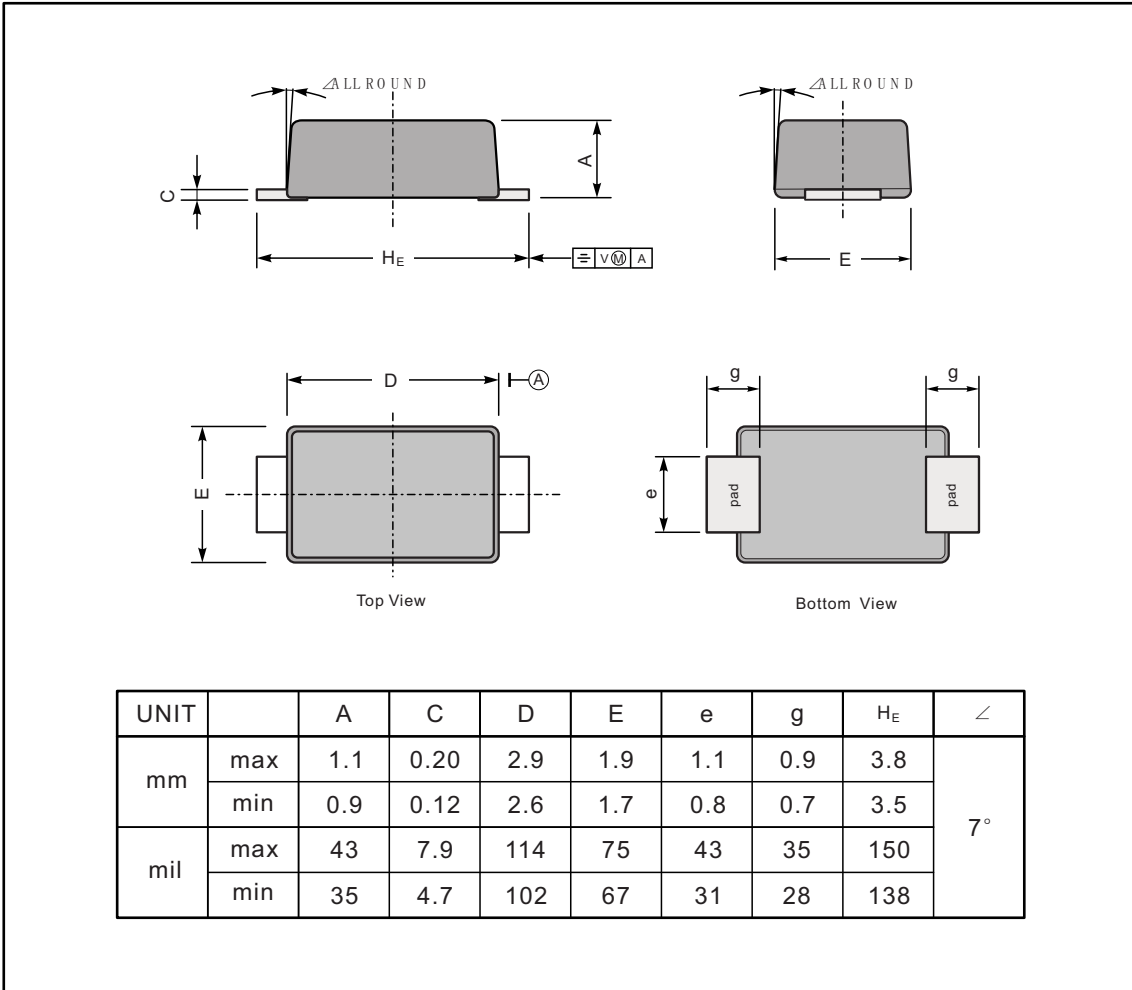

Fig.6- Typical Transient Thermal Impedance



PACKAGE OUTLINE

Plastic surface mounted package; 2 leads



The recommended mounting pad size

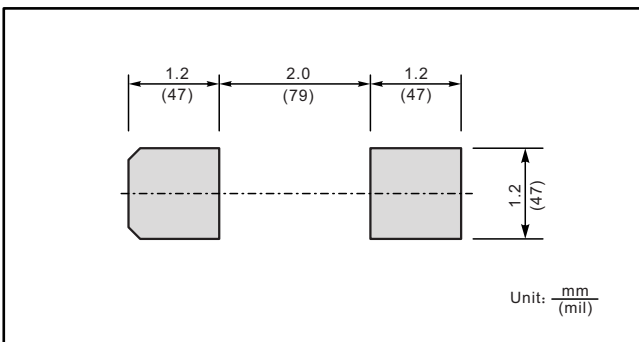

Marking

Type number	Marking code
DS12W	S12
DS14W	S14
DS16W	S16
DS18W	S18
DS110W	S110
DS112W	S112
DS115W	S115
DS120W	S120

• Recommended condition of flow soldering

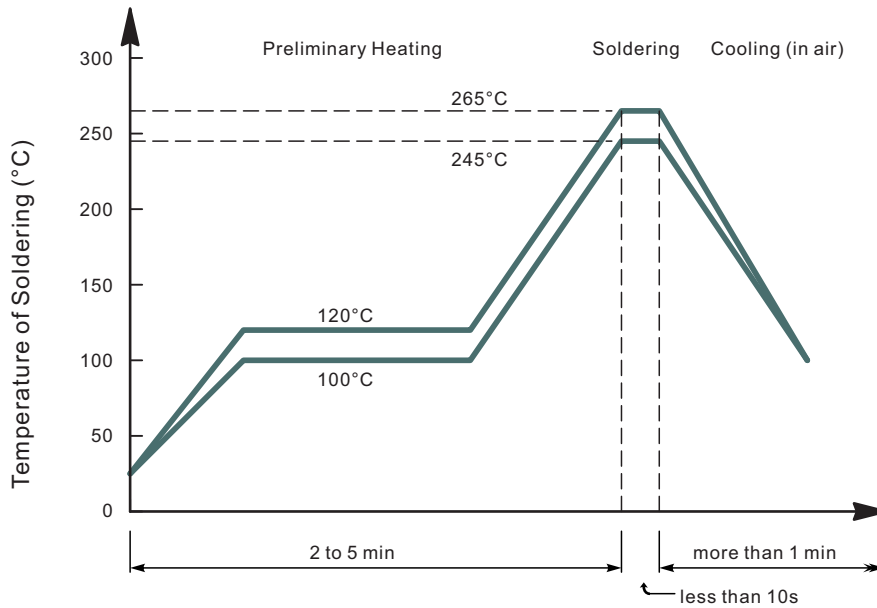

• Recommended condition of reflow soldering

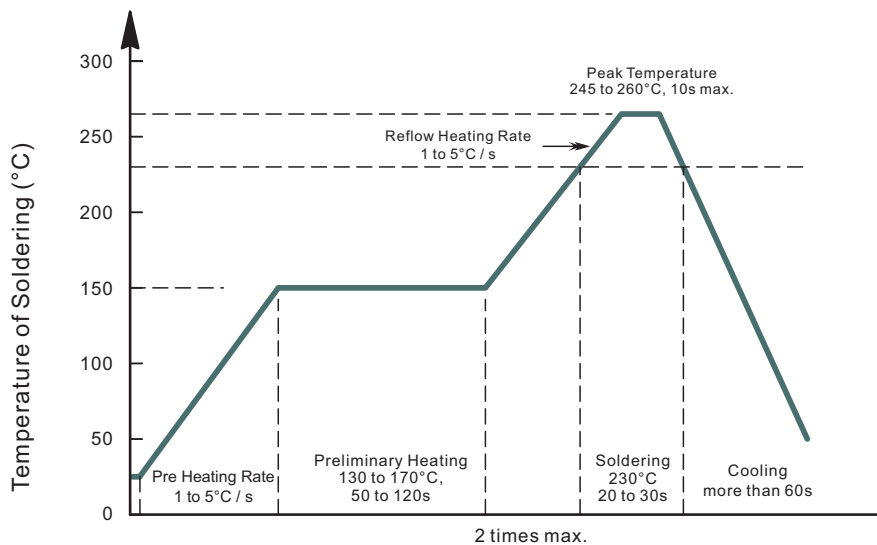

Recommended peak temperature is over 245 °C. If peak temperature is below 245 °C, you may adjust the following parameters; time length of peak temperature (longer), time length of soldering (longer), thickness of solder paste (thicker)

• Condition of hand soldering

Temperature: 350°C
 Time: 3s max.
 Times: one time

• Remark:

Lead free solder paste (96.5Sn/3.0Ag/0.5Cu)

PACKAGING OF DIODE AND BRIDGE RECTIFIERS

REEL PACK

PACKAGE	PACKING CODE	EA PER REEL	EA PER INNER BOX	COMPONENT SPACE (mm)	TAPE SPACE (mm)	REEL DIA (mm)	CARTON SIZE (mm)	EA PER CARTON	GROSS WEIGHT(Kg)
SOD-123F(L)	-W/T	3,000	15,000	---	---	178	390*205*310	120,000	6.964