

**Features**

- Epitaxial Planar Die Construction
- Built-In Biasing Resistors
- Halogen Free. "Green" Device (Note 1)
- Moisture Sensitivity Level 1
- Epoxy Meets UL 94 V-0 Flammability Rating
- Lead Free Finish/RoHS Compliant ("P" Suffix Designates RoHS Compliant. See Ordering Information)

**NPN  
Digital Transistor**

**Maximum Ratings @ 25°C Unless Otherwise Specified**

Parameter	Symbol	Min	Typ	Max	Unit
Supply Voltage	$V_{CC}$	---	50	---	V
Input Voltage	$V_{IN}$	-6	---	40	V
Output Current	$I_O$	---	70	---	mA
	$I_{C(Max)}$	---	100	---	mA
Power Dissipation	$P_D$	---	---	230	mW
Junction Temperature	$T_J$	---	---	150	°C
Storage Temperature	$T_{stg}$	-55	---	150	°C

Note: 1. Halogen free "Green" products are defined as those which contain <900ppm bromine, <900ppm chlorine (<1500ppm total Br + Cl) and <1000ppm antimony compounds.

**SOT-23**

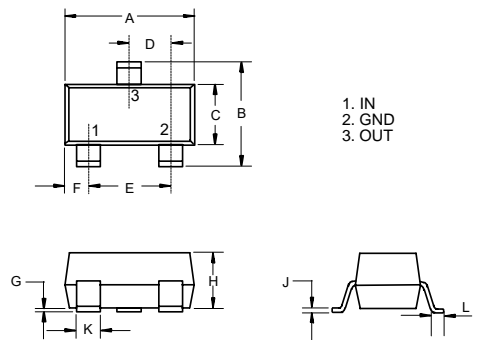

**DIMENSIONS**

DIM	INCHES		MM		NOTE
	MIN	MAX	MIN	MAX	
A	0.110	0.120	2.80	3.04	
B	0.083	0.104	2.10	2.64	
C	0.047	0.055	1.20	1.40	
D	0.034	0.041	0.85	1.05	
E	0.067	0.083	1.70	2.10	
F	0.018	0.024	0.45	0.60	
G	0.0004	0.006	0.01	0.15	
H	0.035	0.043	0.90	1.10	
J	0.003	0.007	0.08	0.18	
K	0.012	0.020	0.30	0.51	
L	0.007	0.020	0.20	0.50	

**Device Marking: 64**

**Internal Structure**

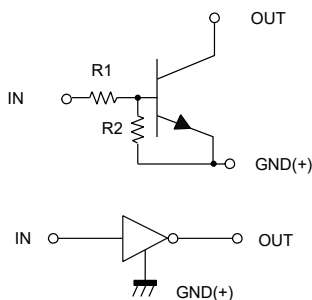

**Suggested Solder Pad Layout**

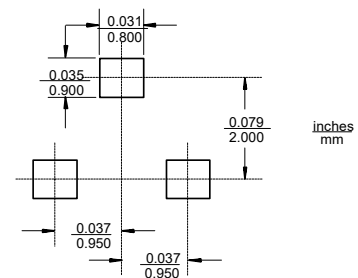

**Electrical Characteristics @ 25°C Unless Otherwise Specified**

Parameter	Symbol	Min	Typ	Max	Unit	Conditions
Input Voltage	$V_{I(off)}$	0.3	---	---	V	$V_{CC}=5V, I_O=100\mu A$
	$V_{I(on)}$	---	---	1.4	V	$V_O=0.3V, I_O=1mA$
Output Voltage	$V_{O(on)}$	---	---	0.3	V	$I_O=5mA, I_I=0.25mA$
Input Current	$I_I$	---	---	0.88	mA	$V_I=5V$
Output Current	$I_{O(off)}$	---	---	0.5	$\mu A$	$V_{CC}=50V, V_I=0$
DC Current Gain	$G_I$	80	---	---		$V_O=10V, I_O=5mA$
Input Resistance	$R_1$	7	10	13	K $\Omega$	
Resistance Ratio	$R_2/R_1$	3.7	4.7	5.7		
Transition Frequency	$f_T$	---	250	---	MHz	$V_{CE}=10V, I_E=-5mA, f=100MHz$

Curve Characteristics

Fig. F - DC Current Gain Characteristics

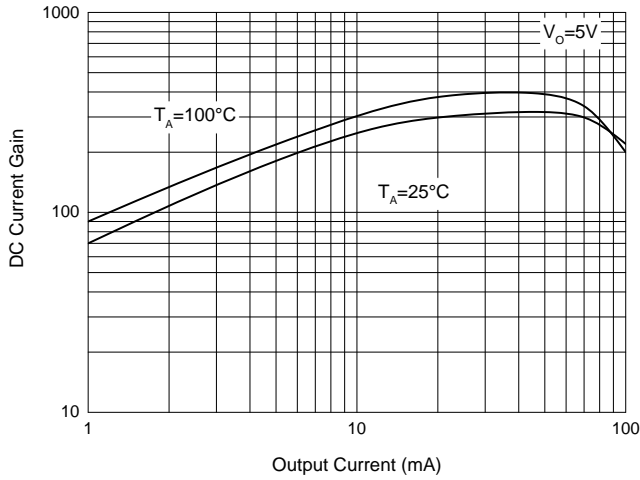

Fig. G - Input Voltage (on) Characteristics

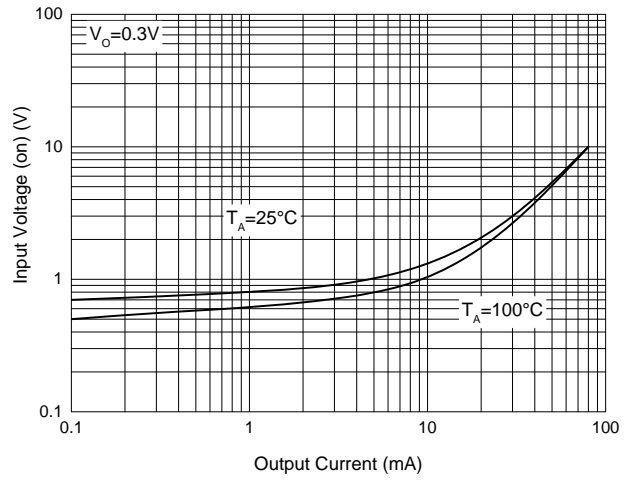

Fig. H - Input Voltage (off) Characteristics

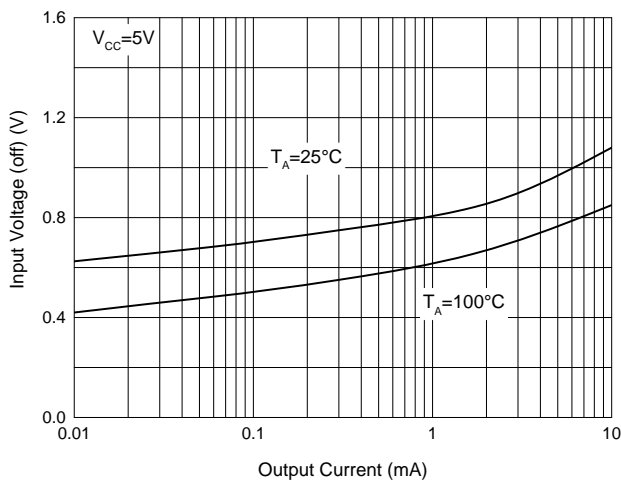

Fig. I - Output Voltage Characteristics

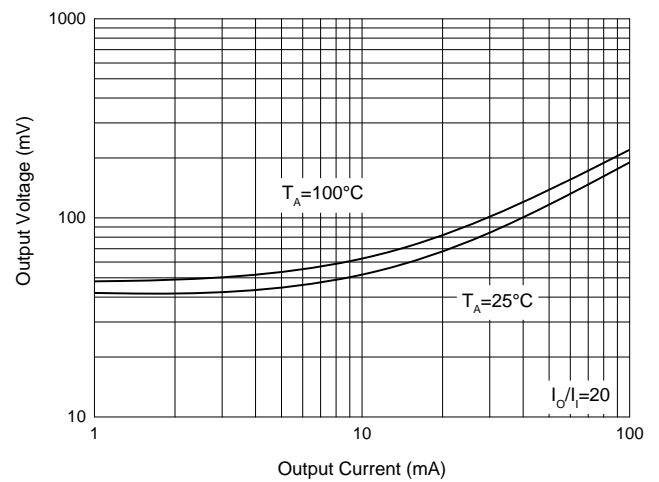

Fig. J - Power Derating Curve

