

Datasheet

The Sure Cross® wireless system is a radio frequency network with integrated I/O that operates in most environments to eliminate the need for wiring runs. Wireless MultiHop data radio networks are formed around a MultiHop master and one or more slaves and extend the range of a Modbus or other serial communication network.

Range can be extended even further using any slave radio as a repeater to create a tree-type network. The MultiHop H10 radios may be powered by either a battery or 10 to 30 V DC power and include Banner's 1-wire serial interface for use with all of Banner's 1-wire serial sensors, such as the QM30VT1 Vibration and Temperature sensor. Up to six sensors may be daisy-chained into a single H10 radio.



Benefits

- Deliver factory automation or IIoT solutions by connecting Banner 1-wire serial sensors for applications such as:
 - Vibration and temperature monitoring for predictive maintenance motor health
 - Ultrasonic distance measurement for tank level monitoring, distance sensing, etc.
 - Temperature and humidity monitoring for energy management, process monitoring, etc.
- MultiHop networks are self-healing, auto-routing RF networks with multiple hops that extend the network's range and improve radio link performance
- Monitor all available 1-wire serial sensor registers previously only available on Modbus sensors
- **Transparency mode**—Global triggers make polling a sensor function identically to a wired Modbus sensor
- **Flexible power options**—10 to 30 V DC or a D-cell battery gives extended battery life
- **Reduced deployment costs**—Allows up to six 1-wire serial sensors to be connected at a time
- **Available solutions**—Integrates with Vibration Monitoring and Predictive Maintenance MultiHop Solutions Kits
- External antenna mounts to the proper location or you can replace it with a higher gain antenna for increased range
- **Eliminate control wires**—The Sure Cross wireless system is a radio frequency network with integrated I/O that removes the need for power and control wires
- **Reduce complexity**—Machine or process reconfiguration made easier; great for retrofit applications
- **Deploy easily**—Simplified installation on existing equipment enables deployment in remote and hard-to-access locations where implementing a wired solution would be difficult, impractical, or not cost-effective
- Selectable transmit power levels of 250 mW or 1 Watt for 900 MHz models and 65 mW for 2.4 GHz models
- Frequency Hopping Spread Spectrum (FHSS) technology ensures reliable data delivery
- Transceivers provide bidirectional communication between the master and slave radios, including fully acknowledged data transmission

Models

Models	Frequency	Power	I/O
DX80DR9M-H10	900 MHz ISM Band	Integrated battery or 10 V DC to 30 V DC	Inputs: 1-Wire serial interface for one 1-wire serial sensing device
DX80DR2M-H10	2.4 GHz ISM Band		

Configuration Instructions

Setting Up Your MultiHop Network

To set up and install your wireless MultiHop network, follow these steps:

1. If your radios have DIP switches, configure the DIP switches of all devices.
2. Connect the sensors to the MultiHop radios if applicable.
3. Apply power to all devices.
4. If your MultiHop radio has rotary dials, set the MultiHop Radio (Slave) ID. If your MultiHop radio has no rotary dials, continue to the next step.
5. Form the wireless network by binding the slave and repeater radios to the master radio. If the binding instructions are not included in this datasheet, refer to the quick start guide or product manual.
6. Observe the LED behavior to verify the devices are communicating with each other.



7. Configure any I/O points to use the sensors connected to the Sure Cross devices.
8. Conduct a site survey between the MultiHop radios. If the site survey instructions are not included in this datasheet, refer to the product manual.
9. Install your wireless sensor network components. If the installation instructions are not included in this datasheet, refer to the product manual.

For additional information, refer to one of the following documents:

- MultiHop Data Radio Quick Start Guide: [152653](#)
- MultiHop Data Radio Instruction Manual: [151317](#)
- MultiHop Register Guide: [155289](#)

Configure the DIP Switches

Before changing DIP switch positions, disconnect the power. Any changes made to the DIP switches are not recognized until after power is cycled to the device.

For devices powered by batteries integrated into the housing, triple-click button 2, then double-click button 2 to reset the device without removing the battery.

For parameters not set using the DIP switches, use the configuration software to make configuration changes. For parameters set using the DIP switches, the DIP switch positions override any changes made using the configuration software.

Access the Internal DIP Switches

Follow these steps to access the internal DIP switches.

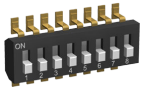

1. Unscrew the four screws that mount the cover to the bottom housing.
2. Remove the cover from the housing without damaging the ribbon cable or the pins the cable plugs into.
3. Gently unplug the ribbon cable from the board mounted into the bottom housing. Skip this step if there is no ribbon cable (integrated battery models) or the ribbon cable is glued down (C housing models).
4. Remove the black cover plate from the bottom of the device's cover. The DIP switches are located behind the rotary dials.
5. Make the necessary changes to the DIP switches.
6. Place the black cover plate back into position and gently push into place.
7. If necessary, plug the ribbon cable in after verifying that the blocked hole lines up with the missing pin.
8. Mount the cover back onto the housing.

DIP Switch Settings

	Switches							
Device Settings	1	2	3	4	5	6	7	8
Serial line baud rate 19200 OR User defined receiver slots	OFF *	OFF *						
Serial line baud rate 38400 OR 32 receiver slots	OFF	ON						
Serial line baud rate 9600 OR 128 receiver slots	ON	OFF						
Serial line baud rate Custom OR 4 receiver slots	ON	ON						
Parity: None			OFF	OFF				
Parity: Even			OFF	ON				
Parity: Odd			ON	OFF				
Disable serial (low power mode) and enable the receiver slots select for switches 1-2			ON *	ON *				
Transmit power 900 MHz radios: 1.00 Watt (30 dBm) 2.4 GHz radios: 0.065 Watts (18 dBm) and 60 ms frame					OFF *			
Transmit power 900 MHz radios: 0.25 Watts (24 dBm) 2.4 GHz radios: 0.065 Watts (18 dBm) and 40 ms frame					ON			
Application mode: Modbus						OFF		
Application mode: Transparency						ON *		
MultiHop radio setting: Repeater							OFF	OFF
MultiHop radio setting: Master							OFF	ON

Switches								
Device Settings	1	2	3	4	5	6	7	8
MultiHop radio setting: Slave							ON *	OFF *
MultiHop radio setting: Reserved							ON	ON

* Default configuration

Baud Rate and Parity—The baud rate (bits per second) is the data transmission rate between the device and whatever it is physically wired to. Set the parity to match the parity of the device you are wired to.

Disable Serial—Disable an unused local serial connection to reduce the power consumption of a data radio powered from the solar assembly or from batteries. All radio communications remain operational.

Receiver Slots—The number of receiver slots indicates the number of times out of 128 slots/frames the radio can transmit to its parent radio. Setting a slave’s receiver slots to four reduces the total power consumption by establishing that the slave can only transmit to its parent four times per 128 slots.

Transmit Power Levels/Frame Size—The 900 MHz data radios can be operated at 1 watt (30 dBm) or 0.250 watt (24 dBm). For most models, the default transmit power is 1 watt. For 2.4 GHz radios, the transmit power is fixed at 0.065 watt (18 dBm) and DIP switch 5 is used to set the frame timing. The default position (OFF) sets the frame timing to 60 milliseconds. To increase throughput, set the frame timing to 40 milliseconds. For battery-powered devices, increasing the throughput decreases battery life.

Wire Your Sure Cross® Device

Use the following wiring diagrams to first wire the sensors and then apply power to the Sure Cross devices.

5-Pin M12 Female Quick Disconnect

This female quick disconnect fitting interfaces with a 1-wire serial sensor. The following information defines the wires and the appropriate connection points in the Sure Cross radio.

5-pin M12 Female Quick Disconnect	Pin	Wire Color	Description
	1	Brown	Power out + (to sensor)
	2	White	Device select
	3	Blue	DC common (GND)
	4	Black	Device output
	5	Gray	Serial comms

Apply Power to the 10-30 V DC Model

Integral 5-pin M12 male quick-disconnect connectors are wired for 10 V DC to 30 V DC power as shown.

5-pin M12 Male Quick Disconnect Connector	Pin	Wire Color	Description
	1	Brown	10 V DC to 30 V DC
	2	White	
	3	Blue	DC common (GND)
	4	Black	
	5	Gray	

Set the Slave ID on a 1-Wire Serial Sensor

To begin configuring the sensors, each sensor must have a Modbus Sensor ID assigned to it. To assign sensor IDs use either the menu system or the configuration software.

To assign the IDs using the configuration software, download the Sensor Configuration Software (p/n [b_3128586](#)) and use the BWA-USB1WIRE-001 cable accessory for the VT1 sensor. Follow the instructions in the Sensor Configuration Software Instruction Manual (p/n [170002](#)) to assign the Sensor Modbus ID.

To use the radio’s menu system, follow these steps:

1. Power on the MultiHop radio and only connect one sensor at a time.
2. Push button 1 (left) until ***DVCFG** appears, then click button 2 (right).
3. Push button 1 until **-S ADR** appears and click button 2.
4. Push button 1 and wait for the radio to read the current sensor ID.
A three-digit value appears with the current sensor ID with a blinking cursor.
5. Use the left button to cycle the value from 0 through 9 and the right button to accept the value and move the cursor to the next digit right.

Each sensor must be assigned a unique slave ID.

6. Push and hold button 2 until SAVING displays on the screen.
7. To repeat for more sensors, unplug the sensor and plug in the next sensor and repeat the steps, using a unique ID.
8. After you have assigned unique slave IDs to all sensors, double-click button 2 to return to the main menu.
9. Plug in all sensors to be attached to that radio.

Bind a MultiHop Radio to a DXM and Assign the Device ID

Before beginning the binding procedure, apply power to all the devices. Separate radios by two (2) meters when running binding procedure. Put only one DXM MultiHop master radio into binding mode at a time to prevent binding the slave radios to the wrong master radio.

Binding MultiHop radios ensures all MultiHop radios within a network communicate only with other radios within the same network. The MultiHop radio master automatically generates a unique binding code when the radio master enters binding mode. This code is then transmitted to all radios within range that are also in binding mode. After a repeater/slave is bound, the repeater/slave radio accepts data only from the master to which it is bound. The binding code defines the network, and all radios within a network must use the same binding code.

1. Enter binding mode on the DXM radio:
 - a) Use the arrow keys select the **ISM Radio** menu on the LCD and press **ENTER**.
 - b) Highlight the **Binding** menu and press **ENTER**.
2. Assign the device address to the repeater or slave radios. Valid device IDs are 11 through 60.
 - For MultiHop radios without rotary dials: Use the DXM arrow keys to select the device ID to assign to the MultiHop radio about to enter binding mode. The DXM assigns this device ID to the next radio that enters binding mode. Only bind one slave radio at a time.
 - For MultiHop radios with rotary dials: Use the MultiHop radio's rotary dials to assign a device ID . The left rotary dial represents the tens digit (1 through 6) and the right dial represents the ones digit (0 through 9) of the device ID. You can leave the DXM "Bind to" address set to 1 because the MultiHop's rotary dials will override that setting.
3. Start binding mode on the DXM radio by pressing **ENTER** on the DXM radio.
4. After entering binding mode on the DXM, put the MultiHop repeater or slave radio into binding mode.
 - For housed radios, triple-click button 2.
 - For board-level radios, triple-click the button.
 - For radios without buttons, refer to the radio's datasheet for instructions on entering binding mode.

After binding is completed, the MultiHop radio automatically exits binding mode and begins operation.
5. Press **BACK** on the DXM to exit binding mode for that specific device address.
The MultiHop radio's LEDs continue to flash red until the DXM exits binding mode with that MultiHop radio.
6. Label the MultiHop radio with the assigned address number for future reference.
7. Repeat these steps, changing the device address, for as many MultiHop radios as are needed for your network.
8. When you are finished binding, press **BACK** on the DXM until you return to the main menu.
All radio devices begin to form the network after the master data radio exits binding mode.

Transparent Mode

In a typical MultiHop system, data radios are constantly powered and provide a direct wireless connection to attached Modbus sensors, which can be polled at any time. With the H10 battery-powered data radio, follow these steps to use transparent mode and enhance your battery life.

To create a transparent link to the sensors, set a few global registers in the master radio (slave ID 1). One register puts all connected radios into a full listening mode called FullMacWhen and the second register enables switch power to all the connected sensors. Using these two registers gives you the benefits of a MultiHop connection to any Banner 1-wire serial sensor without needing connect 10 to 30 V DC to the radio.

After you first boot the master DXM that this H10 radio will be connecting to, set register 6161 to 1 on master radio (slave ID 1) to enable Global Flags.

- Register 6329—FullMacWhen
 - Register 6165—Enable Switch Power
1. Set the registers to a value of 1 and wait a few seconds. All attached H10 radios now act as if they were powered by 10 to 30 V DC.
 2. Poll the data from the attached 1-wire serial sensors.
 3. After the polling cycle of all sensors is complete, set the two registers back to 0.

To properly trigger the global registers, take the necessary data from each sensor, and then shut off the global registers quickly, use a ScriptBasic file. With a ScriptBasic file, the timing of turning on the global registers and collecting the data from the sensors, as well as knowing when the last sensors data has been read ensures that the FullMacWhen and Enable Switch Power are not left on longer than necessary.

Do not leave the global registers on (1) because it will drain the H10 battery much faster.

MultiHop Configuration Software

Use Banner's MultiHop Configuration Software to view your MultiHop radio network and configure the radio and its I/O.

Figure 1. MultiHop Configuration Software Network and Device Overview screen

Name	Role	Modbus Address	Device Address	Parent Address	Signal Strength	Green	Yellow	Red	Misses	Serial Number	Model Number	Build Date	RF FW/PN	RF EE/PN	LCD FW/PN	LCD EE/PN
Master 900MHz HES	Master	1	23046	23046	0	0	0	0	0	154918	180215	001544	175069	3.0C	175070	1.0
DATA RADIO DEVICE	Slave	35	34520	23046	50	0	0	0	50	100056	000000	000000	165062	3.0E	159481	0.2A
DATA RADIO DEVICE	Slave	17	24200	23046	0	0	0	0	0	155272	151687	001544	169893	3.4	157721	1.1
MultiHop Data Radio	Slave	14	64179	23046	0	0	0	0	0	195251	157568	001233	157719	2.2	157722	1.0
DATA RADIO DEVICE	Slave	45	63129	23046	0	0	0	0	0	259737	151687	001415	169893	2.6	157721	1.1
DATA RADIO DEVICE	Slave	19	24203	23046	0	0	0	0	0	155275	151687	001544	169893	3.4	157721	1.1
DATA RADIO DEVICE	Slave	90	4775	23046	0	0	0	0	0	135647	183420	001523	169893	2.6	157721	1.1
MultiHop Data Radio	Slave	15	64180	23046	0	0	0	0	0	195252	157568	001233	157719	2.2	157722	1.0
DATA RADIO DEVICE	Slave	37	56005	23046	0	0	0	0	0	842437	190055	1541	169345	3.1	169449	0.1C
MultiHop Data Radio	Slave	16	64184	23046	0	0	0	0	0	195256	157568	001233	157719	2.2	157722	1.0
DATA RADIO DEVICE	Slave	20	24196	23046	0	0	0	0	0	155268	151687	001544	169893	3.4	157721	1.1
DATA RADIO DEVICE	Slave	36	56006	23046	0	0	0	0	0	842438	190055	1541	169345	3.1	169449	0.1C
MH MGate SID 13	Slave	13	64176	23046	0	0	0	0	0	195248	157568	001233	157719	2.2	157722	1.0
DATA RADIO DEVICE	Slave	18	24202	23046	0	0	0	0	0	155274	151687	001544	169893	3.4	157721	1.1
DATA RADIO DEVICE	Slave	27	9819	23046	0	0	0	0	0	271963	151687	001425	169893	2.6	157721	1.1
MultiHop Radio H12	Repeater	91	55281	23046	78	70	0	0	22	123817	151685	1512	148091	2.2	151696	1.3
DATA RADIO DEVICE	Slave	84	4794	58281	0	0	0	0	0	135866	183420	001523	169893	2.6	157721	1.1
DATA RADIO DEVICE	Slave	32	9821	58281	0	0	0	0	0	271965	151687	001425	169893	2.6	157721	1.1
MH MGate SID 12	Slave	12	64185	58281	0	0	0	0	0	195257	157568	001233	157719	2.2	157722	1.0
MultiHop Data Radio	Slave	78	29005	58281	0	0	0	0	0							
DATA RADIO DEVICE	Slave	31	65198	58281	0	0	0	0	0	261806	151687	001417	169893	2.6	157721	1.1
DATA RADIO DEVICE	Slave	32	4744	58281	0	0	0	0	0	135816	183420	001523	169893	2.6	157721	1.1
MH MGate SID 11	Slave	11	64181	58281	0	0	0	0	0	195253	157568	001233	157719	2.2	157722	1.0
DATA RADIO DEVICE	Slave	83	4743	58281	0	0	0	0	0	135815	183420	001523	169893	2.6	157721	1.1

The software connects to a MultiHop master radio using one of four methods.

- Serial; using a USB to RS-485 (for RS-485 radios) or a USB to RS-232 (for RS-232 radios) converter cable.
- Modbus TCP; using an Ethernet connection to an Ethernet radio master.
- Serial DXM; using a USB cable to a DXM Controller to access a MultiHop master radio.
- TCP DXM; using an Ethernet connection to a DXM Controller to access a MultiHop master radio.

For MultiHop DX80DR9* models, Banner recommends using **BWA-UCT-900**, an RS-485 to USB adapter cable with a wall plug that can power your 900 MHz 1 Watt MultiHop radio while you configure it. The adapter cable is not required when connecting to a DXM Controller.

Download the most recent software revision from the Wireless Reference Library on Banner Engineering's website: www.bannerengineering.com.

Installing Your Sure Cross® Radios

Please refer to one of these instruction manuals to install your wireless network components.

- Performance Wireless I/O Network Instruction Manual: [132607](#)
- MultiHop Data Radio Instruction Manual: [151317](#)

Modbus Addressing Convention

All Modbus addresses refer to Modbus holding registers. When writing your own Modbus scripts, use the appropriate commands for interfacing to holding registers. Parameter description headings refer to addresses in the range of 40000 as is customary with Modbus convention.

Install or Replace the Battery for a DX80 Integrated Battery Model

To install or replace the 3.6 V lithium "D" cell battery in any model with a battery integrated into the housing, follow these steps.

1. Remove the four screws mounting the face plate to the housing and remove the face plate.
2. Remove the discharged battery.
3. Install the new battery, verifying the battery's positive and negative terminals align to the positive and negative terminals of the battery holder mounted within the case.
4. After installing the battery, allow up to 60 seconds for the device to power up.
5. Properly dispose of used batteries according to local regulations by taking it to a hazardous waste collection site, an e-waste disposal center, or other facility qualified to accept lithium batteries.

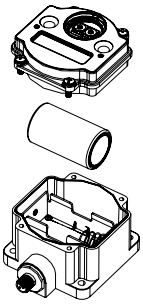

CAUTION: There is a risk of explosion if the battery is replaced incorrectly.

As with all batteries, these are a fire, explosion, and severe burn hazard. Do not burn or expose them to high temperatures. Do not recharge, crush, disassemble, or expose the contents to water.

For non-hazardous locations, the replacement battery is model **BWA-BATT-011**. For non-hazardous or hazardous locations, the replacement battery is Xeno model XL-205F, Banner model **BWA-BATT-001**. For pricing and availability, contact Banner Engineering.

Specifications

MultiHop Radio Specifications

Radio Range¹

900 MHz, 1 Watt: Up to 9.6 km (6 miles)
2.4 GHz, 65 mW: Up to 3.2 km (2 miles)

Antenna Minimum Separation Distance

900 MHz, 150 mW and 250 mW: 2 m (6 ft)
900 MHz, 1 Watt: 4.57 m (15 ft)
2.4 GHz, 65 mW: 0.3 m (1 ft)

Radio Transmit Power

900 MHz, 1 Watt: 30 dBm (1 W) conducted (up to 36 dBm EIRP)
2.4 GHz, 65 mW: 18 dBm (65 mW) conducted, less than or equal to 20 dBm (100 mW) EIRP

Spread Spectrum Technology

FHSS (Frequency Hopping Spread Spectrum)

Antenna Connection

Ext. Reverse Polarity SMA, 50 Ohms
Max Tightening Torque: 0.45 N·m (4 lbf-in)

Radio Packet Size (MultiHop)

900 MHz: 175 bytes (85 Modbus registers)
2.4 GHz: 75 bytes (37 Modbus registers)

900 MHz Compliance (1 Watt)

FCC ID UE3RM1809: FCC Part 15, Subpart C, 15.247
IC: 7044A-RM1809
IFT: RCPBARM13-2283



(NOM approval only applies to 900 MHz models)

2.4 GHz Compliance (MultiHop)

FCC ID UE300DX80-2400: FCC Part 15, Subpart C, 15.247
Radio Equipment Directive (RED) 2014/53/EU
IC: 7044A-DX8024

ANATEL: 15966-21-04042 Este equipamento não tem direito à proteção contra interferência prejudicial e não pode causar interferência em sistemas devidamente autorizados. Para maiores informações, consulte o site da ANATEL www.gov.br/anatel/pt-br/

M-H10 Specifications

Supply Voltage

Integrated battery: 3.6 V DC (internal battery)²
Non-battery: 10 V DC to 30 V DC (Outside the USA: 12 V DC to 24 V DC, ± 10%)

Interface

Two bi-color LED indicators
Two buttons
Six character LCD

Housing

Polycarbonate housing; polyester labels; EDPM rubber cover gasket; nitrile rubber, non-sulphur cured button covers
Weight: 0.26 kg (0.57 lbs)
Mounting: #10 or M5 (SS M5 hardware included)
Max. Tightening Torque: 0.56 N·m (5 lbf-in)

Wiring Access

One 5-pin M12 female quick-disconnect connector and One 5-pin M12 male quick-disconnect connector

Certifications



Banner Engineering Europe Park Lane,
Culliganlaan 2F bus 3,
1831 Diegem, BELGIUM

(CE approval only applies to 2.4 GHz models)

RS-485 Communication Specifications

Communication Hardware (MultiHop RS-485)

Interface: 2-wire half-duplex RS-485
Baud rates: 9.6k, 19.2k (default), or 38.4k via DIP switches; 1200 and 2400 via the MultiHop Configuration Software
Data format: 8 data bits, no parity, 1 stop bit

¹ Radio range is with the 2 dB antenna that ships with the product. High-gain antennas are available, but the range depends on the environment and line of sight. Always verify your wireless network's range by performing a Site Survey.

² For European applications, power this device from a Limited Power Source as defined in EN 60950-1.

Environmental Specifications

Operating Conditions

-40 °C to +85 °C (-40 °F to +185 °F) (Electronics); -20 °C to +80 °C (-4 °F to +176 °F) (LCD)
 95% maximum relative humidity (non-condensing)
 Radiated Immunity: 10 V/m (EN 61000-4-3)

Shock and Vibration

All models meet IEC 60068-2-6 and IEC 60068-2-27 testing criteria
 Shock: 30G 11 ms duration, half sine wave per IEC 60068-2-27
 Vibration: 10 Hz to 55 Hz, 0.5 mm peak-to-peak amplitude per IEC 60068-2-6

Environmental Ratings

IEC IP67; NEMA 6
 For installation and waterproofing instructions, go to www.bannerengineering.com and search for the complete instruction manual (p/n 151317)

Operating the devices at the maximum operating conditions for extended periods can shorten the life of the device.

Dimensions

All measurements are listed in millimeters, unless noted otherwise.

Figure 2. Dimensions for the MultiHop H10 model

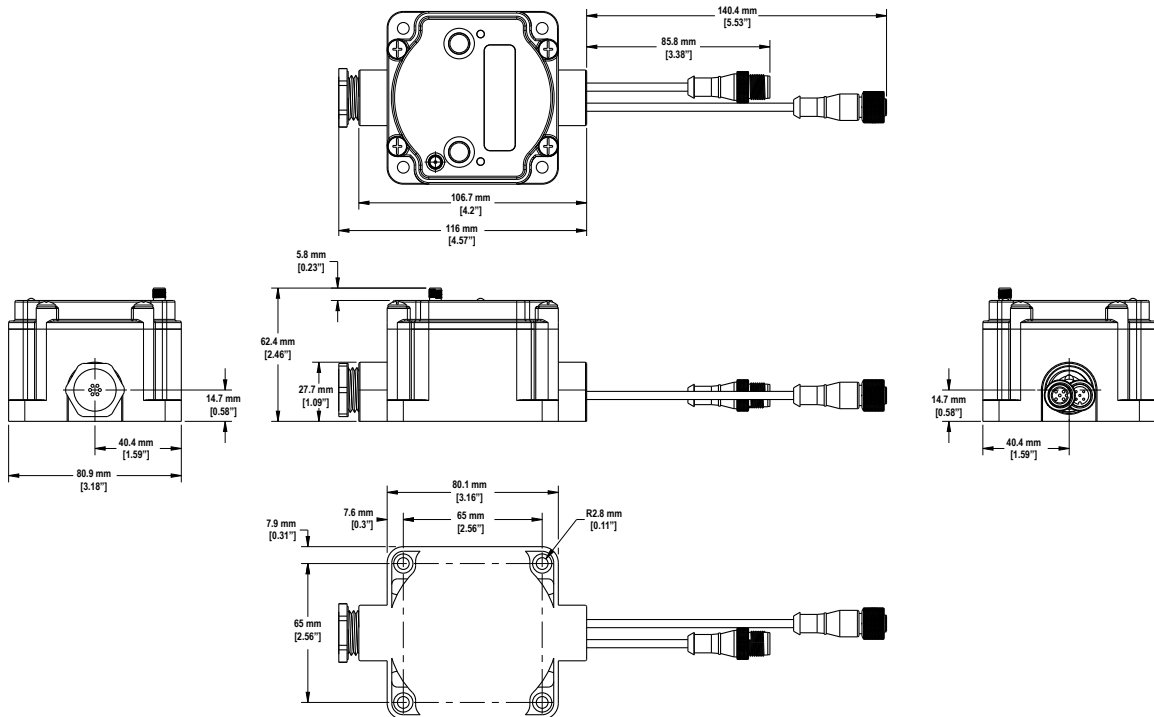



Accessories

Splitter Cordsets

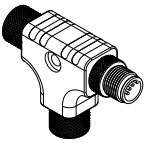
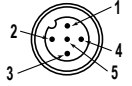
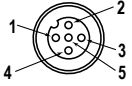
5-Pin Threaded M12 Splitter Cordset with Flat Junction—Double Ended				
Model	Trunk (Male)	Branches (Female)	Pinout (Male)	Pinout (Female)
CSB4-M1251M1250	0.3 m (0.98 ft)	Four (no cable)		
			1 = Brown 2 = White 3 = Blue	4 = Black 5 = Gray

5-Pin Threaded M12 Splitter Tee				
Model	Description		Pinout (Male)	Pinout (Female)
CSB-M1250M1250-T	Female trunk, 1 female branch, 1 male branch		 <p>1 = Brown 2 = White 3 = Blue</p>	 <p>4 = Black 5 = Green/Yellow</p>

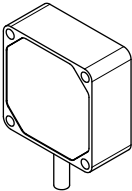
1-Wire Serial Sensors

<p>QM30VT1 Vibration and Temperature Sensor</p> <ul style="list-style-type: none"> Aluminum housing 2.09 m (6.85 ft) cable with a 5-pin M12 male quick disconnect (QD) Datasheet: 212568 		<p>M12FTH4Q Temperature and Humidity Sensor</p> <ul style="list-style-type: none"> ±2% Accuracy, 1-wire serial interface (Requires a 5-pin threaded M12 double-ended cordset less than 3 meters long, such as model DEE2R-5xD.) Datasheet: 162669 	
<p>QM30VT1-QP Vibration and Temperature Sensor</p> <ul style="list-style-type: none"> Aluminum housing 150 mm (6 in) cable with a 5-pin M12 male quick disconnect (QD) Datasheet: 212568 		<p>M12FT4Q Temperature Sensor</p> <ul style="list-style-type: none"> 1-wire serial interface (Requires a 5-pin threaded M12 double-ended cordset less than 3 meters long, such as model DEE2R-5xD.) Datasheet: 162669 	
<p>QM30VT1-SS Vibration and Temperature Sensor</p> <ul style="list-style-type: none"> Stainless steel housing 2.09 m (6.85 ft) cable with a 5-pin M12 male quick disconnect (QD) Datasheet: 212568 			
<p>K50UX1ARA U-GAGE Ultrasonic Sensor</p> <ul style="list-style-type: none"> 1-wire serial interface Range: 100 mm to 1 m (3.94 in to 39.4 in) Datasheet: 191599 			
<p>K50UX1CRA U-GAGE Ultrasonic Sensor</p> <ul style="list-style-type: none"> 1-wire serial interface Range: 300 mm to 3 m (11.8 in to 118 in) Datasheet: 191599 			

Included with Device

- BWA-HW-001: Mounting Hardware Kit, containing four M5-0.8 x 25mm SS screws, four M5-0.8 x 16mm SS screws, four M5-0.8mm SS hex nuts, and four #8-32 x 3/4" SS bolts
- BWA-902-C (900 MHz) or BWA-202-C (2.4 GHz): Antenna, 2 dBd Omni, Rubber Swivel RP-SMA Male. (Not included with Internal antenna models)
- Quick Start Guide (128185 for DX80 Gateways or 152653 for MultiHop models)

Warnings

Install and properly ground a qualified surge suppressor when installing a remote antenna system. Remote antenna configurations installed without surge suppressors invalidate the manufacturer's warranty. Keep the ground wire as short as possible and make all ground connections to a single-point ground system to ensure no ground loops are created. No surge suppressor can absorb all lightning strikes; do not touch the Sure Cross® device or any equipment connected to the Sure Cross device during a thunderstorm.

Exporting Sure Cross® Radios. It is our intent to fully comply with all national and regional regulations regarding radio frequency emissions. **Customers who want to re-export this product to a country other than that to which it was sold must ensure the device is approved in the destination country.** The Sure Cross wireless products were certified for use in these countries using the antenna that ships with the product. When using other antennas, verify you are not exceeding the transmit power levels allowed by local governing agencies. This device has been designed to operate with the antennas listed on Banner Engineering's website and having a maximum gain of 9 dBm. Antennas not included in this list or having a gain greater than 9 dBm are strictly prohibited for use with this device. The required antenna impedance is 50 ohms. To reduce potential radio interference to other users, the antenna type and its gain should be so chosen such that the equivalent isotropically radiated power (EIRP) is not more than that permitted for successful communication. Consult with Banner Engineering Corp. if the destination country is not on this list.



Important: Please download the complete Sure Cross® MultiHop Data Radio technical documentation, available in multiple languages, from www.bannerengineering.com for details on the proper use, applications, Warnings, and installation instructions of this device.



Important: Por favor descargue desde www.bannerengineering.com toda la documentación técnica de los Sure Cross® MultiHop Data Radio, disponibles en múltiples idiomas, para detalles del uso adecuado, aplicaciones, advertencias, y las instrucciones de instalación de estos dispositivos.



Important: Veuillez télécharger la documentation technique complète des Sure Cross® MultiHop Data Radio sur notre site www.bannerengineering.com pour les détails sur leur utilisation correcte, les applications, les notes de sécurité et les instructions de montage.



WARNING:

- **Do not use this device for personnel protection**
- Using this device for personnel protection could result in serious injury or death.
- This device does not include the self-checking redundant circuitry necessary to allow its use in personnel safety applications. A device failure or malfunction can cause either an energized (on) or de-energized (off) output condition.



Important:

- **Never operate a 1 Watt radio without connecting an antenna**
- Operating 1 Watt radios without an antenna connected will damage the radio circuitry.
- To avoid damaging the radio circuitry, never apply power to a Sure Cross® Performance or Sure Cross MultiHop (1 Watt) radio without an antenna connected.



Important:

- **Electrostatic discharge (ESD) sensitive device**
- ESD can damage the device. Damage from inappropriate handling is not covered by warranty.
- Use proper handling procedures to prevent ESD damage. Proper handling procedures include leaving devices in their anti-static packaging until ready for use; wearing anti-static wrist straps; and assembling units on a grounded, static-dissipative surface.

Banner Engineering Corp. Limited Warranty

Banner Engineering Corp. warrants its products to be free from defects in material and workmanship for one year following the date of shipment. Banner Engineering Corp. will repair or replace, free of charge, any product of its manufacture which, at the time it is returned to the factory, is found to have been defective during the warranty period. This warranty does not cover damage or liability for misuse, abuse, or the improper application or installation of the Banner product.

THIS LIMITED WARRANTY IS EXCLUSIVE AND IN LIEU OF ALL OTHER WARRANTIES WHETHER EXPRESS OR IMPLIED (INCLUDING, WITHOUT LIMITATION, ANY WARRANTY OF MERCHANTABILITY OR FITNESS FOR A PARTICULAR PURPOSE), AND WHETHER ARISING UNDER COURSE OF PERFORMANCE, COURSE OF DEALING OR TRADE USAGE.

This Warranty is exclusive and limited to repair or, at the discretion of Banner Engineering Corp., replacement. **IN NO EVENT SHALL BANNER ENGINEERING CORP. BE LIABLE TO BUYER OR ANY OTHER PERSON OR ENTITY FOR ANY EXTRA COSTS, EXPENSES, LOSSES, LOSS OF PROFITS, OR ANY INCIDENTAL, CONSEQUENTIAL OR SPECIAL DAMAGES RESULTING FROM ANY PRODUCT DEFECT OR FROM THE USE OR INABILITY TO USE THE PRODUCT, WHETHER ARISING IN CONTRACT OR WARRANTY, STATUTE, TORT, STRICT LIABILITY, NEGLIGENCE, OR OTHERWISE.**

Banner Engineering Corp. reserves the right to change, modify or improve the design of the product without assuming any obligations or liabilities relating to any product previously manufactured by Banner Engineering Corp. Any misuse, abuse, or improper application or installation of this product or use of the product for personal protection applications when the product is identified as not intended for such purposes will void the product warranty. Any modifications to this product without prior express approval by Banner Engineering Corp will void the product warranties. All specifications published in this document are subject to change; Banner reserves the right to modify product specifications or update documentation at any time. Specifications and product information in English supersede that which is provided in any other language. For the most recent version of any documentation, refer to: www.bannerengineering.com.

For patent information, see www.bannerengineering.com/patents.

Notas Adicionales

Información México: La operación de este equipo está sujeta a las siguientes dos condiciones: 1) es posible que este equipo o dispositivo no cause interferencia perjudicial y 2) este equipo debe aceptar cualquier interferencia, incluyendo la que pueda causar su operación no deseada.

Banner es una marca registrada de Banner Engineering Corp. y podrán ser utilizadas de manera indistinta para referirse al fabricante. "Este equipo ha sido diseñado para operar con las antenas tipo Omnidireccional para una ganancia máxima de antena de 6 dBd y Yagi para una ganancia máxima de antena 10 dBd que en seguida se enlistan. También se incluyen aquellas con aprobación ATEX tipo Omnidireccional siempre que no excedan una ganancia máxima de antena de 6dBd. El uso con este equipo de antenas no incluidas en esta lista o que tengan una ganancia mayor que 6 dBd en tipo omnidireccional y 10 dBd en tipo Yagi, quedan prohibidas. La impedancia requerida de la antena es de 50 ohms."

Antenas SMA	Modelo	Antenas Tipo-N	Modelo
Antena, Omni 902-928 MHz, 2 dBd, junta de caucho, RP-SMA Macho	BWA-902-C	Antena, Omni 902-928 MHz, 6 dBd, fibra de vidrio, 1800mm, N Hembra	BWA-906-A
Antena, Omni 902-928 MHz, 5 dBd, junta de caucho, RP-SMA Macho	BWA-905-C	Antena, Yagi, 900 MHz, 10 dBd, N Hembra	BWA-9Y10-A