

Key Parameters

V_{DRM} / V_{RRM}	2200 V
I_{FAVM}	1100 A ($T_C=100^{\circ}C$)
I_{FSM}	48000 A
V_{T0}	0,75 V
r_T	0,073 m Ω
R_{thJC}	0,0466 K/W
Baseplate	70 mm
Weight	1950 g



For type designation please refer to actual shortform catalog

<http://www.ifbip.com/catalog>

Merkmale

- Druckkontakt- Technologie für hohe Verlässlichkeit
- Industrie-Standard-Gehäuse
- Elektrisch isolierte Grundplatte
- Advanced medium power technology
- Optional: Thermisches Interface Material (TIM) bereits aufgetragen

Features

- Pressure contact technology for high reliability
- Industrial standard package
- Electrically insulated baseplate
- Advanced medium power technology
- Option: Pre-applied thermal interface material (TIM)

Typische Anwendungen

- Gleichrichter für Antriebsapplikationen
- Gleichrichter für UPS
- Batterieladegleichrichter

Typical Applications

- Rectifier for Drives Applications
- Rectifiers for UPS
- Battery chargers



content of customer DMX code	DMX code digit	DMX code digit quantity
serial number	1..7	7
SP material number	8..16	9
datecode (production day)	17..18	2
datecode (production year)	19..20	2
datecode (production month)	21..22	2
vT class	23..26	4
QR class	27..30	4



www.ifbip.com
support@infineon-bip.com



Technische Information / technical information



Netz-Dioden-Modul
Rectifier Diode Module

DZ1100N22K

Infineon Technologies Bipolar
GmbH & Co. KG

DZ1100N22K

DZ1100N22K_TIM

Elektrische Eigenschaften / Electrical properties

Höchstzulässige Werte / Maximum rated values

Periodische Spitzensperrspannung repetitive peak reverse voltages	$T_{vj} = -40^{\circ}\text{C} \dots T_{vj\text{max}}$	V_{RRM}	2200	V
Stoßspitzensperrspannung non-repetitive peak reverse voltage	$T_{vj} = +25^{\circ}\text{C} \dots T_{vj\text{max}}$	V_{RSM}	2300	V
Durchlaßstrom-Grenzeffektivwert maximum RMS on-state current		I_{FRMSM}	1800	A
Dauergrenzstrom average on-state current	$T_C = 100^{\circ}\text{C}$	I_{FAVM}	1100	A
Stoßstrom-Grenzwert surge current	$T_{vj} = 25^{\circ}\text{C}, t_p = 10\text{ms}$ $T_{vj} = T_{vj\text{max}}, t_p = 10\text{ms}$	I_{FSM}	48000 40000	A A
Grenzlastintegral I^2t -value	$T_{vj} = 25^{\circ}\text{C}, t_p = 10\text{ms}$ $T_{vj} = T_{vj\text{max}}, t_p = 10\text{ms}$	I^2t	11520000 8000000	A ² s A ² s

Charakteristische Werte / Characteristic values

Durchlaßspannung on-state voltage	$T_{vj} = T_{vj\text{max}}, i_F = 3000\text{A}$	V_F	max. 1,11	V
Schleusenspannung threshold voltage	$T_{vj} = T_{vj\text{max}}$	$V_{(TO)}$	max. 0,75	V
Ersatzwiderstand slope resistance	$T_{vj} = T_{vj\text{max}}$	r_T	max. 0,073	mΩ
Sperrstrom reverse current	$T_{vj} = T_{vj\text{max}}, V_R = V_{RRM}$	i_R	max. 80	mA
Isolations-Prüfspannung insulation test voltage	RMS, $f = 50\text{Hz}, t = 1\text{sec}$ RMS, $f = 50\text{Hz}, t = 1\text{min}$	V_{ISOL}	3,6 3,0	kV kV

Thermische Eigenschaften / Thermal properties

Innerer Wärmewiderstand thermal resistance, junction to case	pro Modul / per Module, $\Theta = 180^{\circ}$ sin pro Modul / per Module, DC	R_{thJC}	max. 0,0480 max. 0,0466	K/W K/W
Übergangs-Wärmewiderstand thermal resistance, case to heatsink	pro Modul / per Module	R_{thCH}	max. 0,015	K/W
Übergangs-Wärmewiderstand mit TIM thermal resistance, case to heatsink, with TIM	pro Modul / per Module	R_{thCH}	max. 0,012	K/W
Höchstzulässige Sperrschichttemperatur maximum junction temperature		$T_{vj\text{max}}$	150	°C
Betriebstemperatur operating temperature		$T_{c\text{op}}$	- 40...+150	°C
Lagertemperatur storage temperature		T_{stg}	- 40...+150	°C
Lagertemperatur mit TIM storage temperature with TIM		T_{stg}	+5...+50	°C

prepared by: AG		date of publication: 2017-02-08
approved by: ML		revision: 3.2

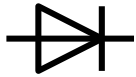

Technische Information /
technical information



Netz-Dioden-Modul
Rectifier Diode Module

DZ1100N22K

Infineon Technologies Bipolar
GmbH & Co. KG

Mechanische Eigenschaften / Mechanical properties

Gehäuse, siehe Anlage case, see annex			Seite 4 page 4	
Si-Element mit Druckkontakt Si-pellet with pressure contact				
Innere Isolation internal insulation	Basisisolierung (Schutzklasse 1, EN 61140) Basic insulation (class 1, IEC 61140)		AIN	
Anzugsdrehmoment für mechanische Anschlüsse mounting torque	Toleranz ±15%	M1	6	Nm
Anzugsdrehmoment für elektrische Anschlüsse terminal connection torque	Toleranz ±10%	M2	18	Nm
Gewicht weight		G	typ. 1950	g
Kriechstrecke creepage distance			64	mm
Schwingfestigkeit vibration resistance	f = 50Hz		50	m/s ²
	file-No.		E 83335	

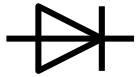

Technische Information /
technical information



Netz-Dioden-Modul
Rectifier Diode Module

DZ1100N22K

Infineon Technologies Bipolar
GmbH & Co. KG

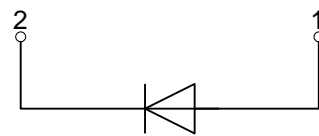
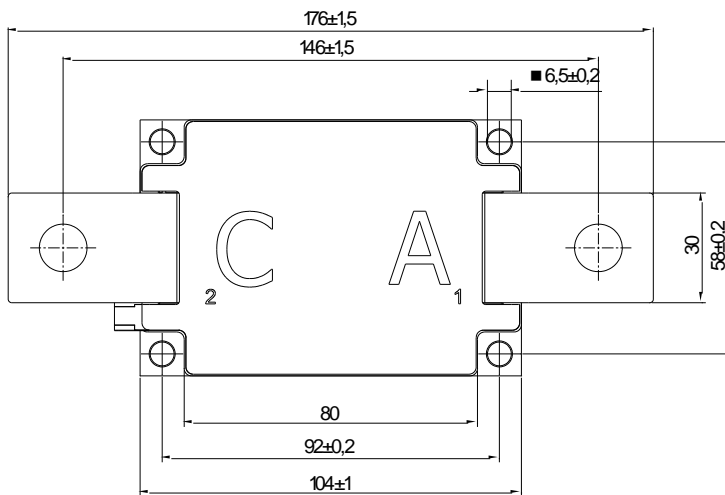
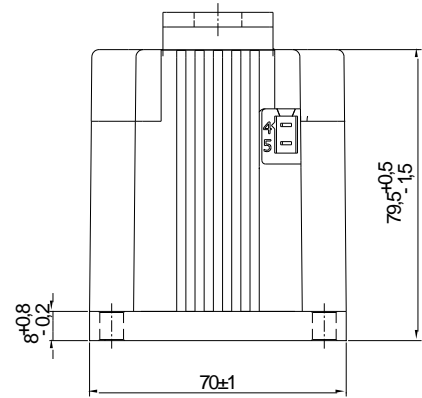
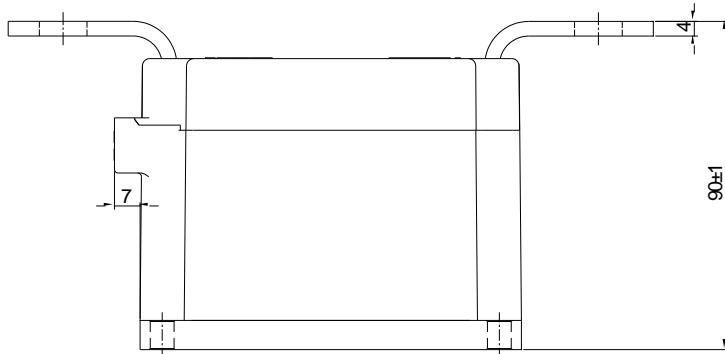

DZ

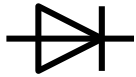

Analytische Elemente des transienten Wärmewiderstandes Z_{thJC} für DC
Analytical elements of transient thermal impedance Z_{thJC} for DC

Pos. n	1	2	3	4	5	6	7
R_{thn} [K/W]	0,0081	0,0252	0,0094	0,0028	0,0011		
τ_n [s]	9,98	4,994	0,3035	0,0188	0,01		

Analytische Funktion / Analytical function:

$$Z_{thJC} = \sum_{n=1}^{n_{max}} R_{thn} \left(1 - e^{-\frac{t}{\tau_n}} \right)$$

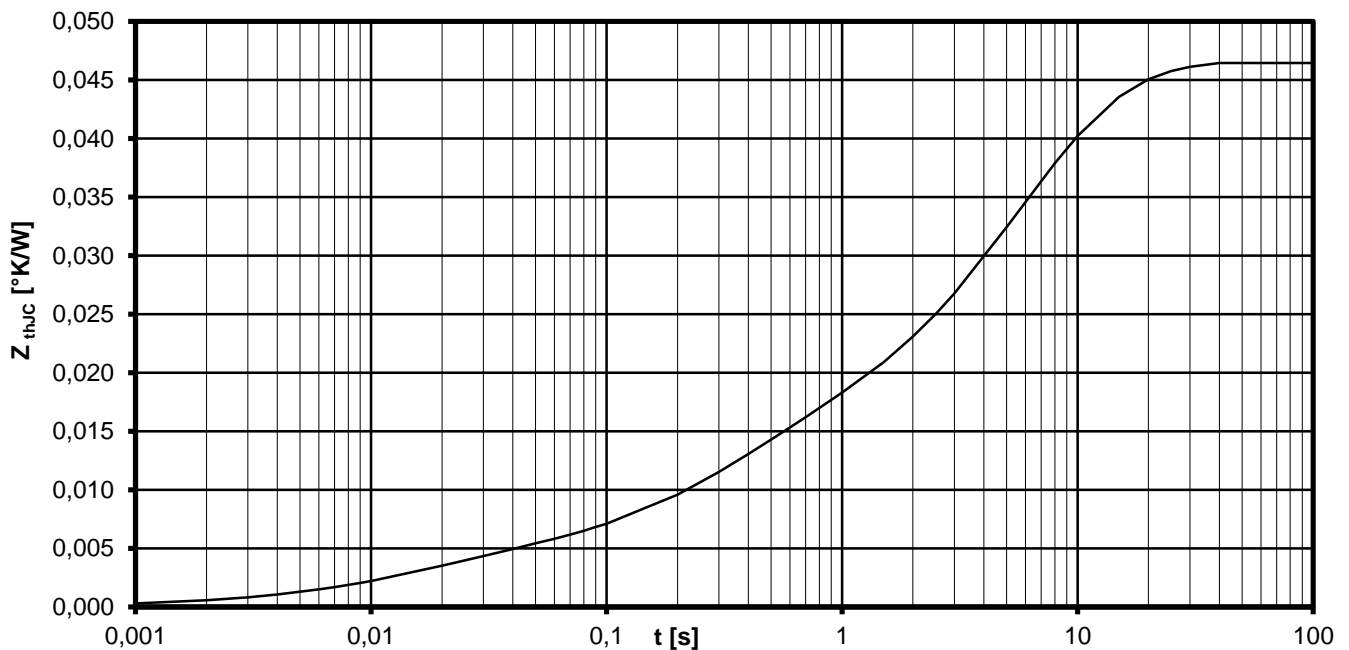

Transienter innerer Wärmewiderstand je Zweig / Transient thermal impedance per arm $Z_{thJC} = f(t)$

Parameter: Stromflußwinkel Θ / Current conduction angle Θ

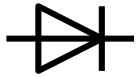

Technische Information /
technical information



Netz-Dioden-Modul
Rectifier Diode Module

DZ1100N22K

Infineon Technologies Bipolar
GmbH & Co. KG

Erhöhung des $Z_{th DC}$ bei Sinus und Rechteckströmen mit unterschiedlichen Stromflusswinkeln Θ
Rise of $Z_{th DC}$ for sinewave and rectangular current with different current conduction angles Θ

$\Delta Z_{th \Theta rec} / \Delta Z_{th \Theta sin}$

	$\Theta = 180^\circ$	$\Theta = 120^\circ$	$\Theta = 90^\circ$	$\Theta = 60^\circ$	$\Theta = 30^\circ$
$\Delta Z_{th \Theta rec}$ [K/W]	0,00126	0,00187	0,00222	0,00259	0,00299
$\Delta Z_{th \Theta sin}$ [K/W]	0,00137	0,00125	0,00236	0,00278	0,00303

$$Z_{th \Theta rec} = Z_{th DC} + \Delta Z_{th \Theta rec}$$

$$Z_{th \Theta sin} = Z_{th DC} + \Delta Z_{th \Theta sin}$$

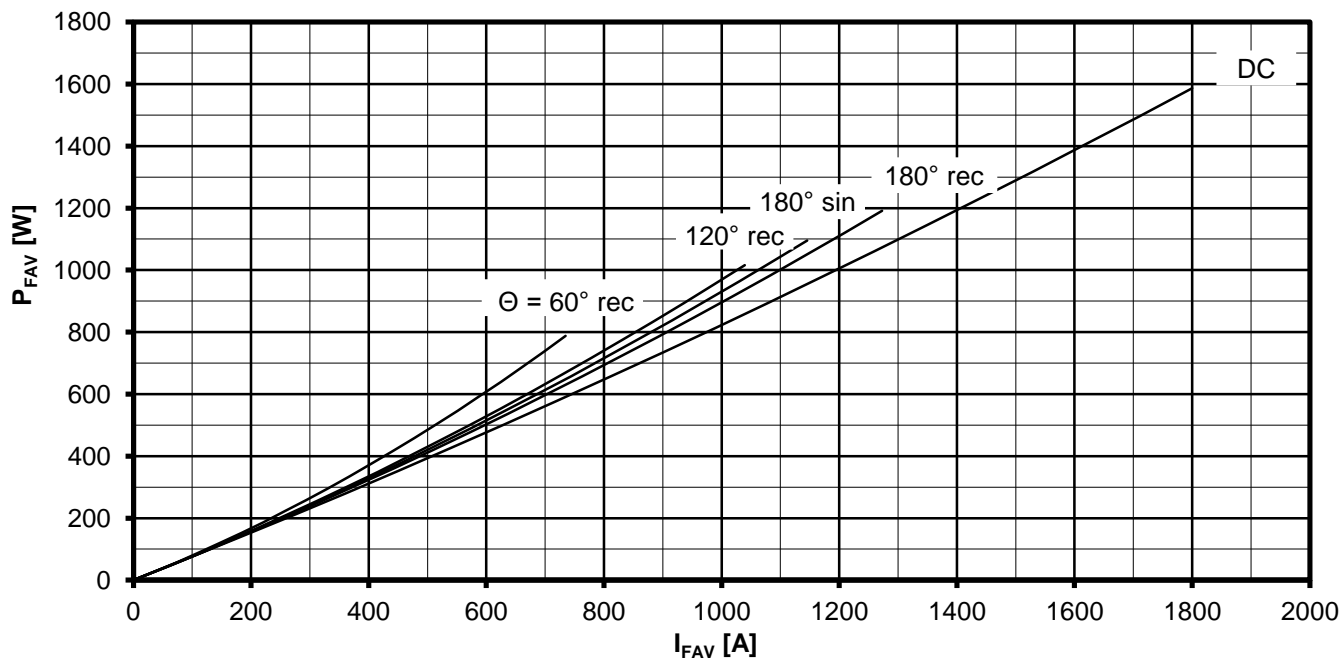

Durchlassverlustleistung je Zweig / On-state power loss per arm $P_{FAV} = f(I_{FAV})$

Parameter: Stromflußwinkel / Current conduction angle Θ

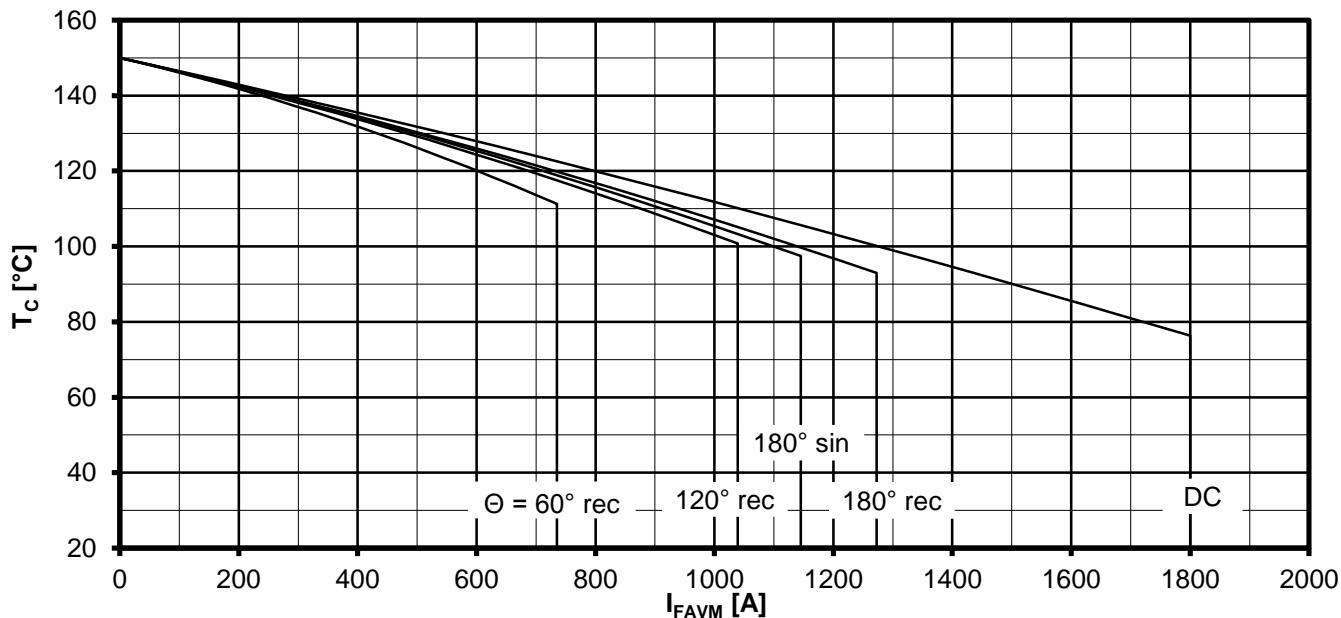

Höchstzulässige Gehäusetemperatur / Maximum allowable case temperature $T_C = f(I_{FAVM})$

Strombelastung je Zweig / Current load per arm

Berechnungsgrundlage P_{TAV}
Calculation base P_{TAV}

Parameter: Stromflußwinkel Θ / Current conduction angle Θ

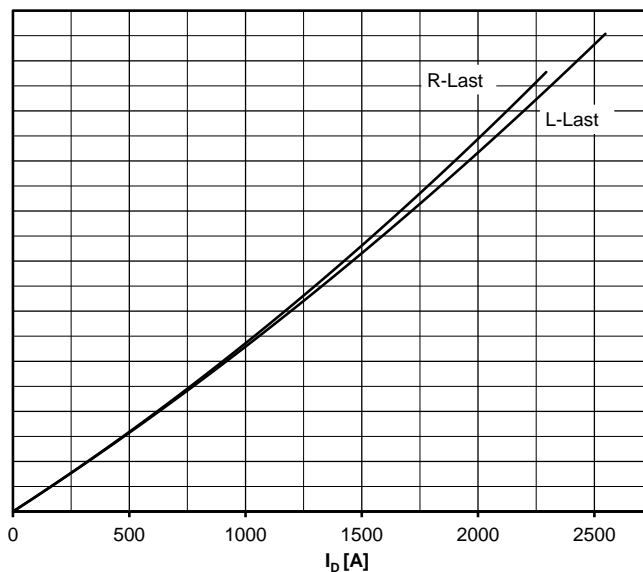
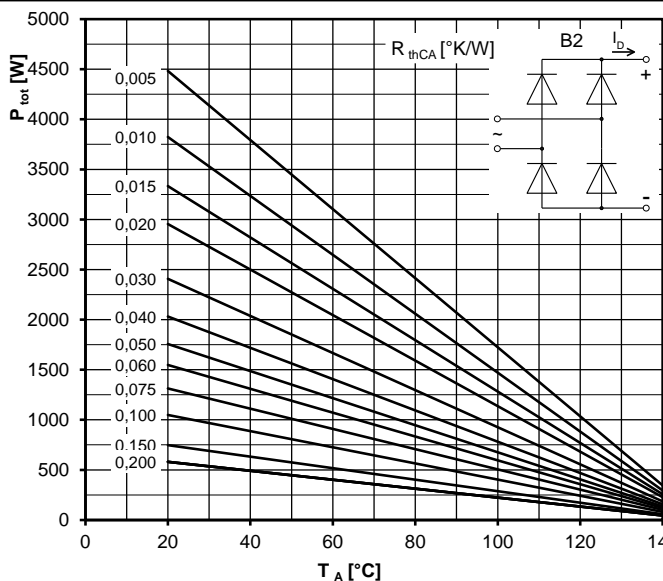

Höchstzulässiger Ausgangsstrom / Maximum rated output current I_b

B2- Zweipuls-Brückenschaltung / Two-pulse bridge circuit

Gesamtverlustleistung der Schaltung / Total power dissipation at circuit P_{tot}

Parameter:

Wärmewiderstand zwischen den Gehäusen und Umgebung / Thermal resistance cases to ambient R_{thCA}

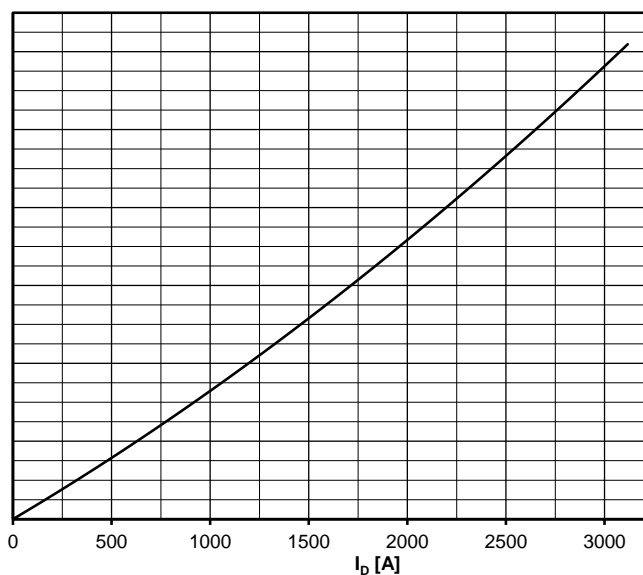
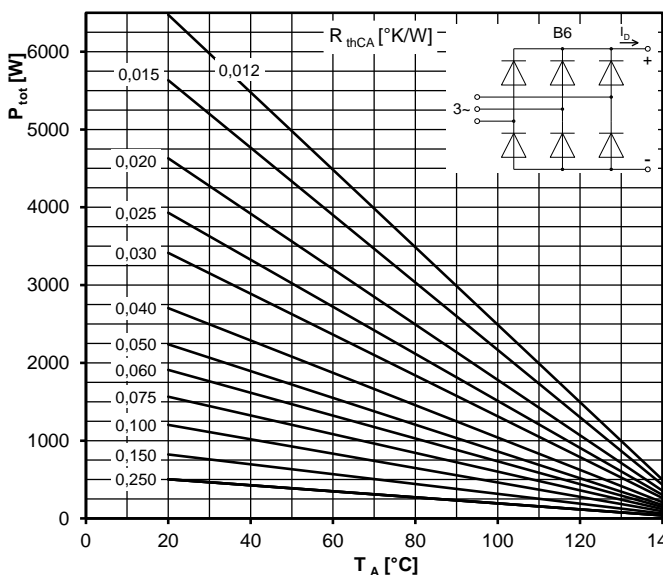

Höchstzulässiger Ausgangsstrom / Maximum rated output current I_b

B6- Sechspuls-Brückenschaltung / Six-pulse bridge circuit

Gesamtverlustleistung der Schaltung / Total power dissipation at circuit P_{tot}

Parameter:

Wärmewiderstand zwischen den Gehäusen und Umgebung / Thermal resistance cases to ambient R_{thCA}

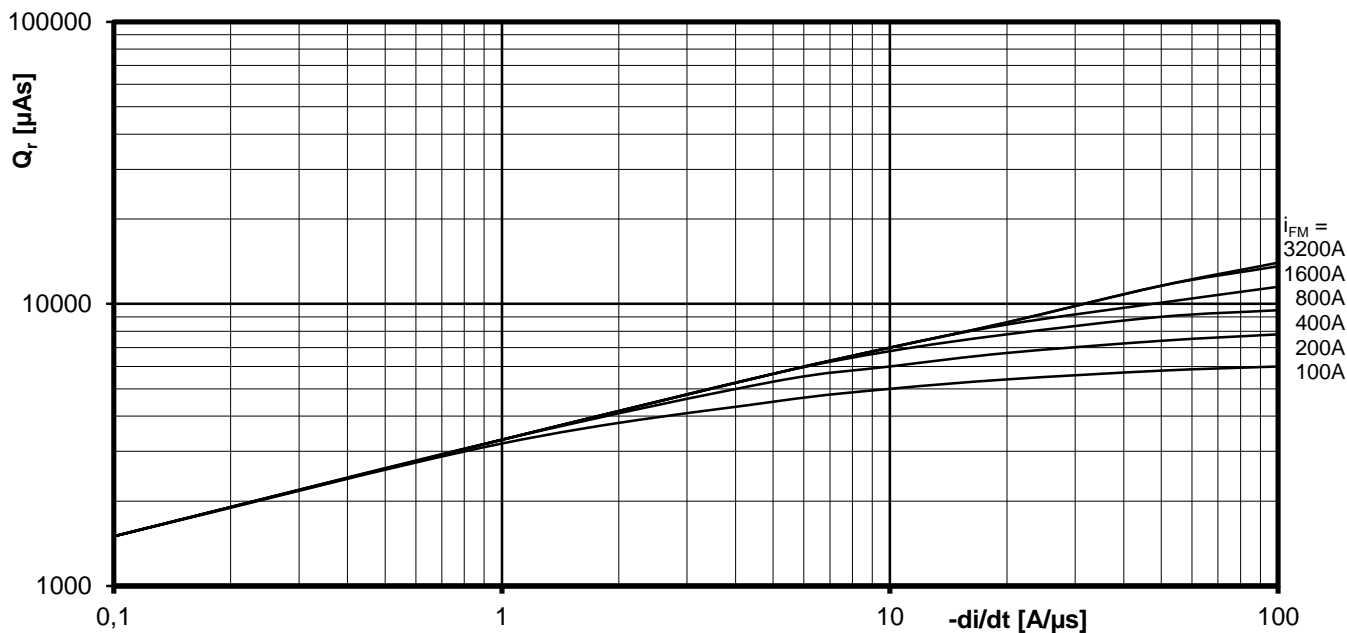

Sperrverzögerungsladung / Recovered charge $Q_r = f(-di/dt)$

$$T_{vj} = T_{vjmax}, V_R \leq 0,5 V_{RRM}, V_{RM} = 0,8 V_{RRM}$$

Parameter: Durchlaßstrom / On-state current i_{FM}

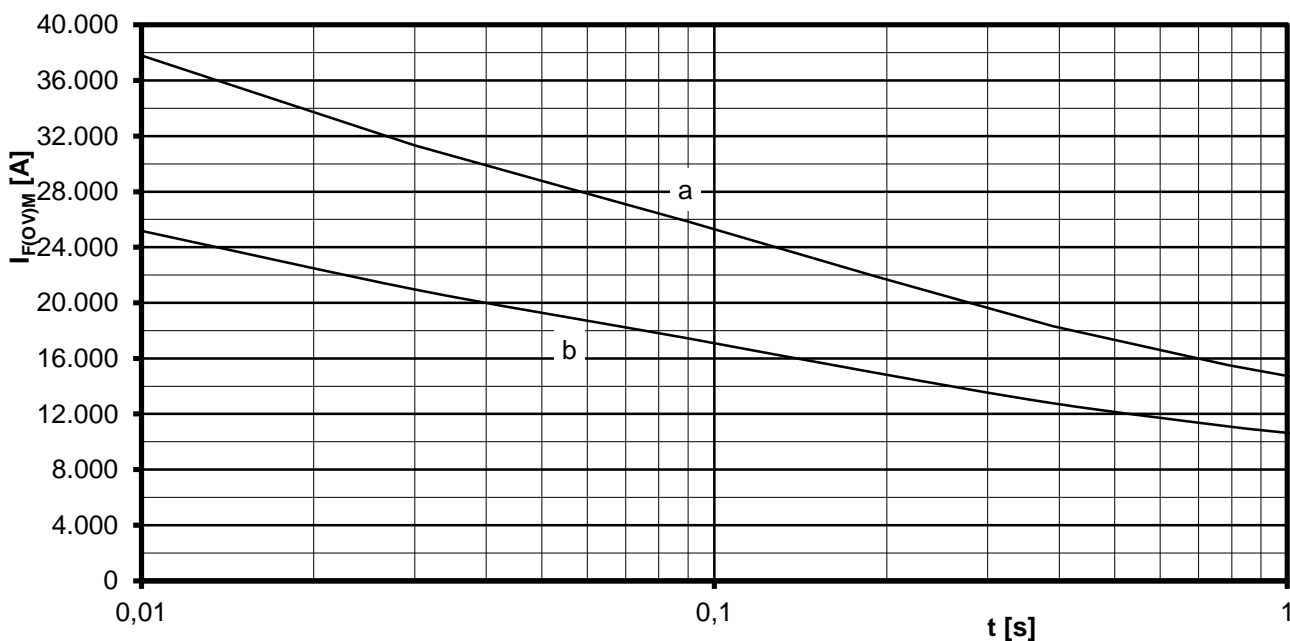

Grenzstrom je Zweig / Maximum overload on-state current per arm $I_{F(OV)M} = f(t), V_{RM} = 0,8 V_{RRM}$

a: Leerlauf / No-load conditions

b: Vorlaststrom je Zweig / Pre-load current per arm $I_{FAV(vor)} = I_{FAVM}$

$T_a = 25^\circ\text{C}$, Wasserkühlung / water cooling Kühlkörper / Heatsink type: KW70 (4 l/min)