

One Sensor Detects All Kinds of Metal at Equal Distance

- Ideal for use on conveyors with work pieces of different metals
- Detects aluminum and copper at the same distance as iron and stainless steel
- Offers up to three times the detection distance for aluminum compared to conventional inductive sensors
- Shielded for flush mounting in metal
- Prewired with 2 meters (6.56 ft) of cable



Ordering Information

■ SENSORS

Sensing head	Detecting distance	Output			
		NPN-NO	NPN-NC	PNP-NO	PNP-NC
M12	2 mm (0.08 in)	E2EV-X2C1	E2EV-X2C2	E2EV-X2B1	E2EV-X2B2
M18	5 mm (0.20 in)	E2EV-X5C1	E2EV-X5C2	E2EV-X5B1	E2EV-X5B2
M30	10 mm (0.39 in)	E2EV-X10C1	E2EV-X10C2	E2EV-X10B1	E2EV-X10B2

■ ACCESSORIES

Description		Part number
Mounting brackets	Fits M12 size sensors Fits M18 size sensors Fits M30 size sensors	Y92E-B12 Y92E-B18 Y92E-B30
Protective covers for shielded sensors	Fits M12 size sensors Fits M18 size sensors Fits M30 size sensors	Y92E-E12-2 Y92E-E18-2 Y92E-E30-2

■ REPLACEMENT PARTS

Description		Part number
Mounting hardware including one pair of metal nuts and washers	Fits M12 size sensors (supplied with each sensor) Fits M18 size sensors (supplied with each sensor) Fits M30 size sensors (supplied with each sensor)	M12-MHWS M18-MHWS M30-MHWS

Specifications

Part number		E2EV-X2□□	E2EV-X5□□	E2EV-X10□□
Sensor type		Inductive		
Body	Size	M12	M18	M30
	Type	Shielded		
Supply voltage		10 to 30 VDC, max. ripple 10% peak-to-peak		
Current consumption		15 mA max.		
Detectable object type		Ferrous and non-ferrous metals		
Effective detecting distance (with standard target)		2 mm ±10% (0.08 in)	5 mm ±10% (0.20 in)	10 mm ±10% (0.39 in)
Usable detecting range (with standard target)		0 to 1.4 mm (0 to 0.06 in)	0 to 3.5 mm (0 to 0.14 in)	0 to 7 mm (0 to 0.28 in)
Standard target size aluminum, L x W x H		12 x 12 x 1 mm (0.47 x 0.47 x 0.04 in)	18 x 18 x 1 mm (0.71 x 0.71 x 0.04 in)	30 x 30 x 1 mm (1.18 x 1.18 x 0.04 in)
Differential travel		10% max. of effective detecting distance		
Control output	DC solid-state	Type	NPN-NO (E2EV-X□C1) NPN-NC (E2EV-X□C2) PNP-NO (E2EV-X□B1) PNP-NC (E2EV-X□B2)	
		Max. load	100 mA max.	
		Max. on-state voltage drop	2 VDC (See graph in Engineering Data section)	
Response frequency		150 Hz	70 Hz	70 Hz
Circuit protection		Output short circuit, surge voltage, reverse polarity		
Indicators		Target present (red LED)		
Materials	Housing	Nickel-plated brass		
	Sensing face	ABS		
Mounting		Two M12 nuts included. Bracket Y92E-B12 optional.	Two M18 nuts included. Bracket Y92E-B18 optional.	Two M30 nuts included. Bracket Y92E-B30 optional.
Connections	Prewired	3-conductor cable, 2 m (6.56 ft) length		
Weight		120 g (4.23 oz.)	140 g (5.5 oz.)	190 g (7.5 oz.)
Enclosure ratings	UL	—		
	NEMA	1, 3, 4, 6, 12, 13		
	IEC 144	IP67		
Approvals	UL	—		
	CSA	—		
Ambient operating temperature		-10° to 55°C (14° to 131°F)		
Vibration		10 to 55 Hz, 1.5 mm (0.06 in) double amplitude for 2 hours each in X, Y, and Z directions		
Shock		Approx. 100 G's, 10 times each in X, Y, and Z directions		

Operation

OUTPUT CIRCUIT DIAGRAMS AND CONNECTIONS

NPN Output Type

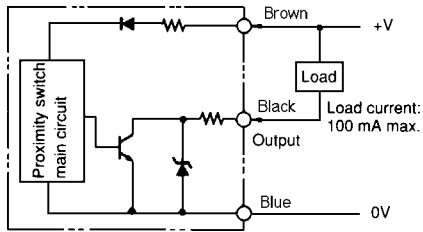

PNP Output Type

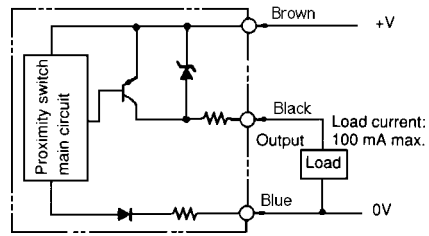

Note: IEC colors are shown in parentheses.

TIMING CHARTS

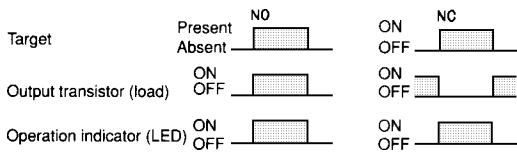

Engineering Data

OPERATING RANGE

E2EV-X2□□

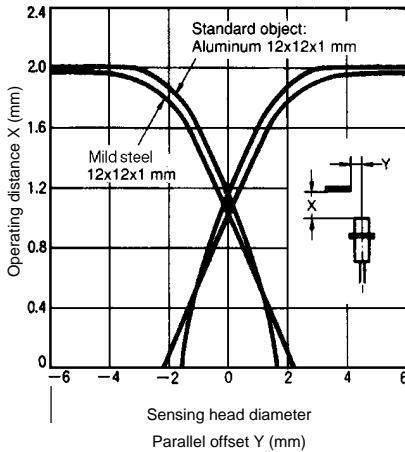

E2EV-X5□□

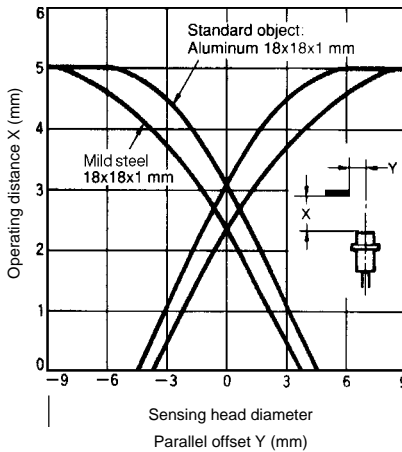

E2EV-X10□□

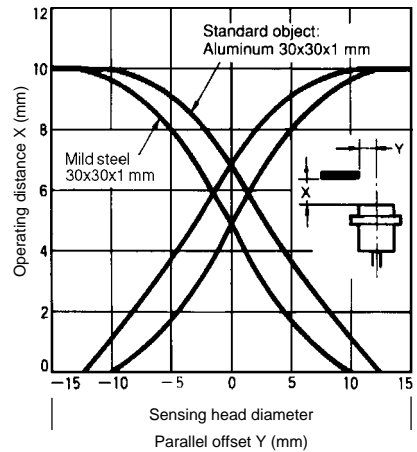

■ SENSING DISTANCE vs. SIZE AND MATERIAL OF TARGET

E2EV-X2□□

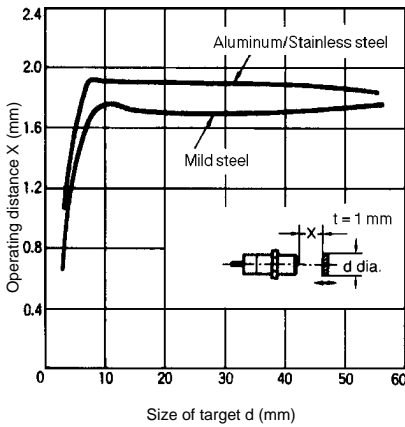

E2EV-X5□□

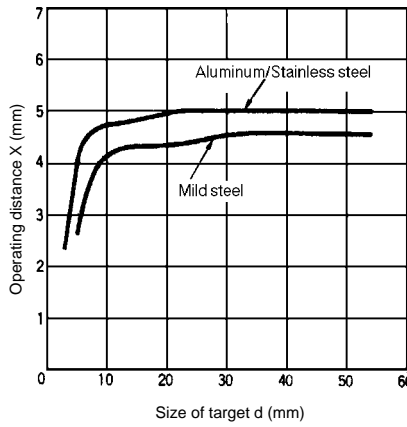

E2EV-X10□□

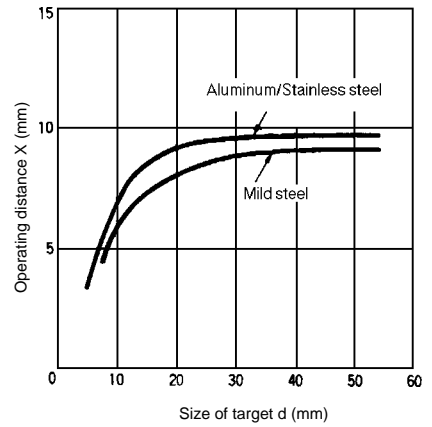

■ ON-STATE VOLTAGE DROP

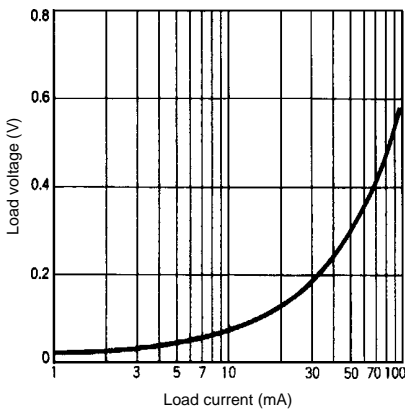

Dimensions

Unit: mm (inch)

E2EV-X2□□

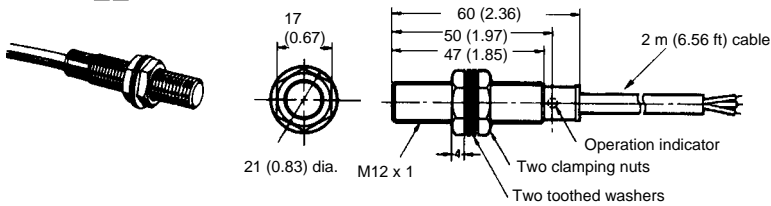

E2EV-X5□□

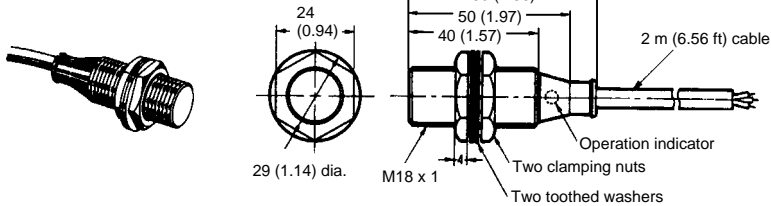

Mounting holes

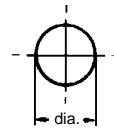

Model	Diameter
E2EV-X2□□	12.5 mm (0.49 in)
E2EV-X5□□	18.5 mm (0.73 in)
E2EV-X10□□	30.5 mm (1.20 in)

E2EV-X10□□

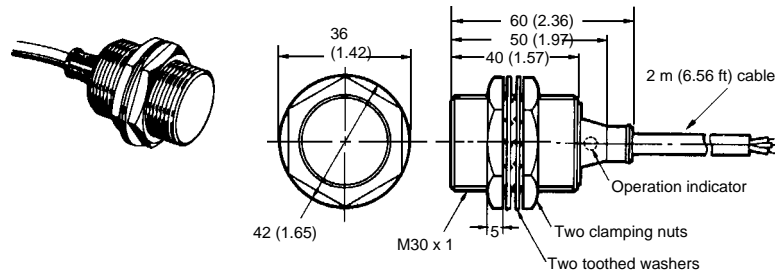

Precautions

■ EFFECTS OF SURROUNDING METALS

When mounting a proximity sensor flush with a metallic panel, provide the minimum distance shown. This prevents the sensor from being affected by metallic objects other than the target.

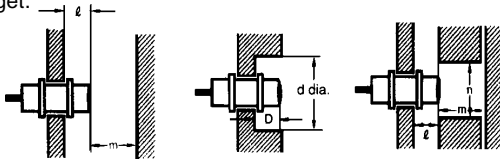

Model	E2EV-X2□□	E2EV-X5□□	E2EV-X10□□
<i>l</i>	0	0	0
<i>d</i>	12 mm (0.47 in)	18 mm (0.71 in)	30 mm (1.18 in)
<i>D</i>	0	0	0
<i>m</i>	8 mm (0.31 in)	20 mm (0.79 in)	40 mm (1.57 in)
<i>n</i>	18 mm (0.71 in)	27 mm (1.06 in)	45 mm (1.77 in)

■ MUTUAL INTERFERENCE

To prevent mutual interference between two sensors mounted opposite or parallel to each other, be sure to space the two sensors at a distance greater than that shown here.

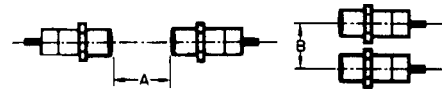

Model	A	B
E2EV-X2□□	30 mm (1.18 in)	20 mm (0.79 in)
E2EV-X5□□	50 mm (1.97 in)	35 mm (1.38 in)
E2EV-X10□□	100 mm (3.94 in)	70 mm (2.76 in)