

Welding Proximity Sensor E2EW Series

DC 2-wire/DC 3-wire

Stable detection in lines containing both aluminum and iron

- Equivalent sensing distances for both iron and aluminum *1
- Enables common design for lines with both iron and aluminum *1
- The exceptional sensing range *2, which means fewer false detections and thereby fewer unexpected stoppages.
- OMRON's unique fluororesin coating technologies enable long-lasting spatter resistance *4, eliminates the need to replace for 10 years *3.
- Durable full metal body to reduce unexpected stoppages
- 2-output (NO+NC) models and models with IO-Link *1 are also available.
- Laser printed information (sensing distance on the sensor head, model on the cable, and model on the metal part of the connector model) can be reducing errors during sensor replacement. *5
- Equipped with a function, which effectively cancels pulse noise of current magnetic field. *1
- UL certification (UL60947-5-2) and CSA certification (CSA C22.2 UL60947-5-2-14)



For the most recent information on models that have been certified for safety standards, refer to your OMRON website.



Be sure to read *Safety Precautions* on page 35.

*1. PREMIUM Models only.

*2. Based on September 2021 OMRON investigation.

*3. This value assumes that the sensor operates 10 hours a day in an arc welding environment and is cleaned once a month (12 times a year). If our previous model (E2EF-Q) needs to be replaced once every 3 times it is cleaned, the E2EW-Q Proximity Sensor needs to be replaced once every 180 times it is cleaned. This means that there is no need to replace the E2EW-Q Proximity Sensor for 10 or more years.

*4. Models with spatter-resistant coating only.

*5. Models without spatter-resistant coating only.

E2EW Series Model Number Legend

E2EW - (1) X (2) (3) (4) (5) (6) - (7) - (8) (9)

No.	Type	Code	Meaning	Remarks
(1)	Case	Blank	Without spatter-resistant coating	
		Q	With spatter-resistant coating	
(2)	Sensing distance	Number	Sensing distance (Unit: mm)	
(3)	Output configuration	B	DC 3-wire PNP open collector	Whether the D model has polarity is defined by number (8).
		C	DC 3-wire NPN open collector	
		D	DC 2-wire polarity/no polarity	
(4)	Operation mode	1	Normally open (NO)	
		2	Normally closed (NC)	
		3	Normally open, Normally closed (NO+NC)	
(5)	IO-Link baud rate	Blank	Non IO-Link compliant	
		D	COM2 (38.4kbps)	
		T	COM3 (230.4kbps)	
(6)	Size	12	M12	
		18	M18	
		30	M30	
(7)	Connection method	Blank	Pre-wired Models	
		M1	M12 Connector Models	
		M1TGJ	M12 Pre-wired Smartclick Connector Models DC 2-wire	
		M1TJ	M12 Pre-wired Smartclick Connector Models DC 3-wire	
(8)	DC 2-wire polarity	Blank	Polarity	
		T	No polarity	
(9)	Cable length	Number M	Cable length	

Note: The purpose of this model number legend is to provide understanding of the meaning of specifications from the model number. Models are not available for all combinations of code numbers.

E2EW Series

Selection Guide

Proximity Sensor

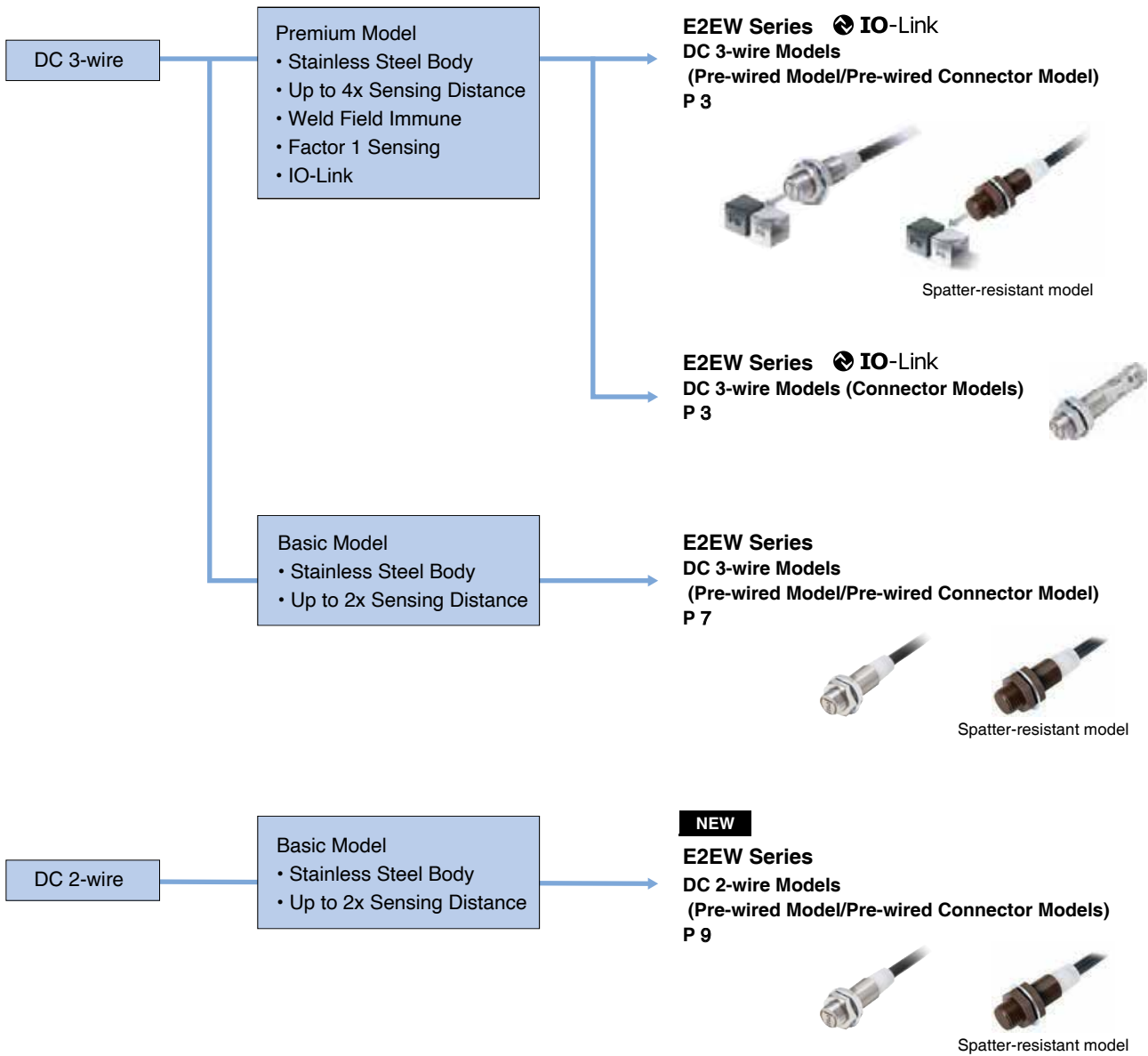

Connector Cable



E2EW Series

Ordering Information

PREMIUM Model

E2EW Series (Quadruple distance model)

DC 3-wire [Refer to *Ratings and Specifications* on page 24, *Dimensions* on page 38.]

Size (Sensing distance)	Connection method	Operation mode	Model	
			PNP	NPN
M12 (7 mm)	Pre-wired (2 m) *1	NO	E2EW-X7B1T12 2M	E2EW-X7C112 2M
		NC	E2EW-X7B212 2M	E2EW-X7C212 2M
		NO+NC	E2EW-X7B3T12 2M	E2EW-X7C312 2M
	M12 Pre-wired Smartclick Connector (0.3 m)	NO	E2EW-X7B1T12-M1TJ 0.3M	E2EW-X7C112-M1TJ 0.3M
		NC	E2EW-X7B212-M1TJ 0.3M	E2EW-X7C212-M1TJ 0.3M
		NO+NC	E2EW-X7B3T12-M1TJ 0.3M	E2EW-X7C312-M1TJ 0.3M
	M12 Connector	NO	E2EW-X7B1T12-M1	E2EW-X7C112-M1
		NC	E2EW-X7B212-M1	E2EW-X7C212-M1
		NO+NC	E2EW-X7B3T12-M1	E2EW-X7C312-M1
M18 (12 mm)	Pre-wired (2 m) *1	NO	E2EW-X12B1T18 2M	E2EW-X12C118 2M
		NC	E2EW-X12B218 2M	E2EW-X12C218 2M
		NO+NC	E2EW-X12B3T18 2M	E2EW-X12C318 2M
	M12 Pre-wired Smartclick Connector (0.3 m)	NO	E2EW-X12B1T18-M1TJ 0.3M	E2EW-X12C118-M1TJ 0.3M
		NC	E2EW-X12B218-M1TJ 0.3M	E2EW-X12C218-M1TJ 0.3M
		NO+NC	E2EW-X12B3T18-M1TJ 0.3M	E2EW-X12C318-M1TJ 0.3M
	M12 Connector	NO	E2EW-X12B1T18-M1	E2EW-X12C118-M1
		NC	E2EW-X12B218-M1	E2EW-X12C218-M1
		NO+NC	E2EW-X12B3T18-M1	E2EW-X12C318-M1
M30 (22 mm)	Pre-wired (2 m) *1	NO	E2EW-X22B1T30 2M	E2EW-X22C130 2M
		NC	E2EW-X22B230 2M	E2EW-X22C230 2M
		NO+NC	E2EW-X22B3T30 2M	E2EW-X22C330 2M
	M12 Pre-wired Smartclick Connector (0.3 m)	NO	E2EW-X22B1T30-M1TJ 0.3M	E2EW-X22C130-M1TJ 0.3M
		NC	E2EW-X22B230-M1TJ 0.3M	E2EW-X22C230-M1TJ 0.3M
		NO+NC	E2EW-X22B3T30-M1TJ 0.3M	E2EW-X22C330-M1TJ 0.3M
	M12 Connector	NO	E2EW-X22B1T30-M1	E2EW-X22C130-M1
		NC	E2EW-X22B230-M1	E2EW-X22C230-M1
		NO+NC	E2EW-X22B3T30-M1	E2EW-X22C330-M1

*1. Models with 5-m cable length are also available with "5M" suffix. (Example: E2EW-X7B1T12 5M)

Note: 1. When embedding the Proximity Sensor in metal, refer to *Influence of Surrounding Metal* on page 36.

2. Models in are equipped with IO-Link (COM3). For IO-Link (COM2), select a model number with the format of "E2EW-X " (Example: E2EW-X7B1D12 2M).

Operation mode NO can be changed to NC via IO-Link communications.

3. IO-Link is not supported for NC-type PNP outputs or all types of NPN outputs.

PREMIUM Model

E2EW Series (Triple distance model)

DC 3-wire [Refer to Ratings and Specifications on page 24, Dimensions on page 38.]

Size (Sensing distance)	Connection method	Operation mode	Model	
			PNP	NPN
M12 (6 mm)	Pre-wired (2 m) *1	NO	E2EW-X6B1T12 2M	E2EW-X6C112 2M
		NC	E2EW-X6B212 2M	E2EW-X6C212 2M
		NO+NC	E2EW-X6B3T12 2M	E2EW-X6C312 2M
	M12 Pre-wired Smartclick Connector (0.3 m)	NO	E2EW-X6B1T12-M1TJ 0.3M	E2EW-X6C112-M1TJ 0.3M
		NC	E2EW-X6B212-M1TJ 0.3M	E2EW-X6C212-M1TJ 0.3M
		NO+NC	E2EW-X6B3T12-M1TJ 0.3M	E2EW-X6C312-M1TJ 0.3M
	M12 Connector	NO	E2EW-X6B1T12-M1	E2EW-X6C112-M1
		NC	E2EW-X6B212-M1	E2EW-X6C212-M1
		NO+NC	E2EW-X6B3T12-M1	E2EW-X6C312-M1
M18 (10 mm)	Pre-wired (2 m) *1	NO	E2EW-X10B1T18 2M	E2EW-X10C118 2M
		NC	E2EW-X10B218 2M	E2EW-X10C218 2M
		NO+NC	E2EW-X10B3T18 2M	E2EW-X10C318 2M
	M12 Pre-wired Smartclick Connector (0.3 m)	NO	E2EW-X10B1T18-M1TJ 0.3M	E2EW-X10C118-M1TJ 0.3M
		NC	E2EW-X10B218-M1TJ 0.3M	E2EW-X10C218-M1TJ 0.3M
		NO+NC	E2EW-X10B3T18-M1TJ 0.3M	E2EW-X10C318-M1TJ 0.3M
	M12 Connector	NO	E2EW-X10B1T18-M1	E2EW-X10C118-M1
		NC	E2EW-X10B218-M1	E2EW-X10C218-M1
		NO+NC	E2EW-X10B3T18-M1	E2EW-X10C318-M1
M30 (20 mm)	Pre-wired (2 m) *1	NO	E2EW-X20B1T30 2M	E2EW-X20C130 2M
		NC	E2EW-X20B230 2M	E2EW-X20C230 2M
		NO+NC	E2EW-X20B3T30 2M	E2EW-X20C330 2M
	M12 Pre-wired Smartclick Connector (0.3 m)	NO	E2EW-X20B1T30-M1TJ 0.3M	E2EW-X20C130-M1TJ 0.3M
		NC	E2EW-X20B230-M1TJ 0.3M	E2EW-X20C230-M1TJ 0.3M
		NO+NC	E2EW-X20B3T30-M1TJ 0.3M	E2EW-X20C330-M1TJ 0.3M
	M12 Connector	NO	E2EW-X20B1T30-M1	E2EW-X20C130-M1
		NC	E2EW-X20B230-M1	E2EW-X20C230-M1
		NO+NC	E2EW-X20B3T30-M1	E2EW-X20C330-M1

*1. Models with 5-m cable length are also available with "5M" suffix. (Example: E2EW-X6B1T12 5M)

Note: 1. When embedding the Proximity Sensor in metal, refer to *Influence of Surrounding Metal* on page 36.2. Models in are equipped with IO-Link (COM3). For IO-Link (COM2), select a model number with the format of "E2EW-X□□□□□□"
(Example: E2EW-X6B1D12 2M).

Operation mode NO can be changed to NC via IO-Link communications.

3. IO-Link is not supported for NC-type PNP outputs or all types of NPN outputs.

E2EW Series

PREMIUM Model

E2EW-Q Series (Spatter-resistant Quadruple distance model)

DC 3-wire [Refer to Ratings and Specifications on page 24, Dimensions on page 38.]

Size (Sensing distance)	Connection method	Operation mode	Model	
			PNP	NPN
M12 (7 mm)	Pre-wired (2 m) *1	NO	E2EW-QX7B1T12 2M	E2EW-QX7C112 2M
		NC	E2EW-QX7B212 2M	E2EW-QX7C212 2M
		NO+NC	E2EW-QX7B3T12 2M	E2EW-QX7C312 2M
	M12 Pre-wired Smartclick Connector (0.3 m)	NO	E2EW-QX7B1T12-M1TJ 0.3M	E2EW-QX7C112-M1TJ 0.3M
		NC	E2EW-QX7B212-M1TJ 0.3M	E2EW-QX7C212-M1TJ 0.3M
		NO+NC	E2EW-QX7B3T12-M1TJ 0.3M	E2EW-QX7C312-M1TJ 0.3M
	M12 Connector	NO	E2EW-QX7B1T12-M1	E2EW-QX7C112-M1
		NC	E2EW-QX7B212-M1	E2EW-QX7C212-M1
		NO+NC	E2EW-QX7B3T12-M1	E2EW-QX7C312-M1
M18 (12 mm)	Pre-wired (2 m) *1	NO	E2EW-QX12B1T18 2M	E2EW-QX12C118 2M
		NC	E2EW-QX12B218 2M	E2EW-QX12C218 2M
		NO+NC	E2EW-QX12B3T18 2M	E2EW-QX12C318 2M
	M12 Pre-wired Smartclick Connector (0.3 m)	NO	E2EW-QX12B1T18-M1TJ 0.3M	E2EW-QX12C118-M1TJ 0.3M
		NC	E2EW-QX12B218-M1TJ 0.3M	E2EW-QX12C218-M1TJ 0.3M
		NO+NC	E2EW-QX12B3T18-M1TJ 0.3M	E2EW-QX12C318-M1TJ 0.3M
	M12 Connector	NO	E2EW-QX12B1T18-M1	E2EW-QX12C118-M1
		NC	E2EW-QX12B218-M1	E2EW-QX12C218-M1
		NO+NC	E2EW-QX12B3T18-M1	E2EW-QX12C318-M1
M30 (22 mm)	Pre-wired (2 m) *1	NO	E2EW-QX22B1T30 2M	E2EW-QX22C130 2M
		NC	E2EW-QX22B230 2M	E2EW-QX22C230 2M
		NO+NC	E2EW-QX22B3T30 2M	E2EW-QX22C330 2M
	M12 Pre-wired Smartclick Connector (0.3 m)	NO	E2EW-QX22B1T30-M1TJ 0.3M	E2EW-QX22C130-M1TJ 0.3M
		NC	E2EW-QX22B230-M1TJ 0.3M	E2EW-QX22C230-M1TJ 0.3M
		NO+NC	E2EW-QX22B3T30-M1TJ 0.3M	E2EW-QX22C330-M1TJ 0.3M
	M12 Connector	NO	E2EW-QX22B1T30-M1	E2EW-QX22C130-M1
		NC	E2EW-QX22B230-M1	E2EW-QX22C230-M1
		NO+NC	E2EW-QX22B3T30-M1	E2EW-QX22C330-M1

*1. Models with 5-m cable length are also available with "5M" suffix. (Example: E2EW-QX7B1T12 5M)

Note: 1. When embedding the Proximity Sensor in metal, refer to *Influence of Surrounding Metal* on page 36.

2. Models in are equipped with IO-Link (COM3). For IO-Link (COM2), select a model number with the format of "E2EW-QX " (Example: E2EW-QX7B1D12 2M).

Operation mode NO can be changed to NC via IO-Link communications.

3. IO-Link is not supported for NC-type PNP outputs or all types of NPN outputs.

PREMIUM Model

E2EW-Q Series (Spatter-resistant Triple distance model)

DC 3-wire [Refer to Ratings and Specifications on page 24, Dimensions on page 38.]

Size (Sensing distance)	Connection method	Operation mode	Model	
			PNP	NPN
M12 (6 mm)	Pre-wired (2 m) *1	NO	E2EW-QX6B1T12 2M	E2EW-QX6C112 2M
		NC	E2EW-QX6B212 2M	E2EW-QX6C212 2M
		NO+NC	E2EW-QX6B3T12 2M	E2EW-QX6C312 2M
	M12 Pre-wired Smartclick Connector (0.3 m)	NO	E2EW-QX6B1T12-M1TJ 0.3M	E2EW-QX6C112-M1TJ 0.3M
		NC	E2EW-QX6B212-M1TJ 0.3M	E2EW-QX6C212-M1TJ 0.3M
		NO+NC	E2EW-QX6B3T12-M1TJ 0.3M	E2EW-QX6C312-M1TJ 0.3M
	M12 Connector	NO	E2EW-QX6B1T12-M1	E2EW-QX6C112-M1
		NC	E2EW-QX6B212-M1	E2EW-QX6C212-M1
		NO+NC	E2EW-QX6B3T12-M1	E2EW-QX6C312-M1
M18 (10 mm)	Pre-wired (2 m) *1	NO	E2EW-QX10B1T18 2M	E2EW-QX10C118 2M
		NC	E2EW-QX10B218 2M	E2EW-QX10C218 2M
		NO+NC	E2EW-QX10B3T18 2M	E2EW-QX10C318 2M
	M12 Pre-wired Smartclick Connector (0.3 m)	NO	E2EW-QX10B1T18-M1TJ 0.3M	E2EW-QX10C118-M1TJ 0.3M
		NC	E2EW-QX10B218-M1TJ 0.3M	E2EW-QX10C218-M1TJ 0.3M
		NO+NC	E2EW-QX10B3T18-M1TJ 0.3M	E2EW-QX10C318-M1TJ 0.3M
	M12 Connector	NO	E2EW-QX10B1T18-M1	E2EW-QX10C118-M1
		NC	E2EW-QX10B218-M1	E2EW-QX10C218-M1
		NO+NC	E2EW-QX10B3T18-M1	E2EW-QX10C318-M1
M30 (20 mm)	Pre-wired (2 m) *1	NO	E2EW-QX20B1T30 2M	E2EW-QX20C130 2M
		NC	E2EW-QX20B230 2M	E2EW-QX20C230 2M
		NO+NC	E2EW-QX20B3T30 2M	E2EW-QX20C330 2M
	M12 Pre-wired Smartclick Connector (0.3 m)	NO	E2EW-QX20B1T30-M1TJ 0.3M	E2EW-QX20C130-M1TJ 0.3M
		NC	E2EW-QX20B230-M1TJ 0.3M	E2EW-QX20C230-M1TJ 0.3M
		NO+NC	E2EW-QX20B3T30-M1TJ 0.3M	E2EW-QX20C330-M1TJ 0.3M
	M12 Connector	NO	E2EW-QX20B1T30-M1	E2EW-QX20C130-M1
		NC	E2EW-QX20B230-M1	E2EW-QX20C230-M1
		NO+NC	E2EW-QX20B3T30-M1	E2EW-QX20C330-M1

*1. Models with 5-m cable length are also available with "5M" suffix. (Example: E2EW-QX6B1T12 5M)

Note: 1. When embedding the Proximity Sensor in metal, refer to *Influence of Surrounding Metal* on page 36.2. Models in are equipped with IO-Link (COM3). For IO-Link (COM2), select a model number with the format of "E2EW-QX " (Example: E2EW-QX6B1D12 2M).

Operation mode NO can be changed to NC via IO-Link communications.

3. IO-Link is not supported for NC-type PNP outputs or all types of NPN outputs.

E2EW Series

BASIC Model

E2EW Series (Double distance model) **NEW**

DC 3-wire [Refer to *Ratings and Specifications* on page 25, *Dimensions* on page 39.]

Size (Sensing distance)	Connection method	Operation mode *2	Model	
			PNP	NPN
M12 (3 mm)	Pre-wired (2 m) *1	NO	E2EW-X3B112 2M	E2EW-X3C112 2M
		NO+NC	E2EW-X3B312 2M	E2EW-X3C312 2M
	M12 Pre-wired Smartclick Connector (0.3 m)	NO	E2EW-X3B112-M1TJ 0.3M	E2EW-X3C112-M1TJ 0.3M
		NO+NC	E2EW-X3B312-M1TJ 0.3M	E2EW-X3C312-M1TJ 0.3M
M18 (7 mm)	Pre-wired (2 m) *1	NO	E2EW-X7B118 2M	E2EW-X7C118 2M
		NO+NC	E2EW-X7B318 2M	E2EW-X7C318 2M
	M12 Pre-wired Smartclick Connector (0.3 m)	NO	E2EW-X7B118-M1TJ 0.3M	E2EW-X7C118-M1TJ 0.3M
		NO+NC	E2EW-X7B318-M1TJ 0.3M	E2EW-X7C318-M1TJ 0.3M
M30 (12 mm)	Pre-wired (2 m) *1	NO	E2EW-X12B130 2M	E2EW-X12C130 2M
		NO+NC	E2EW-X12B330 2M	E2EW-X12C330 2M
	M12 Pre-wired Smartclick Connector (0.3 m)	NO	E2EW-X12B130-M1TJ 0.3M	E2EW-X12C130-M1TJ 0.3M
		NO+NC	E2EW-X12B330-M1TJ 0.3M	E2EW-X12C330-M1TJ 0.3M

BASIC Model

E2EW Series (Single distance model)

DC 3-wire [Refer to *Ratings and Specifications* on page 25, *Dimensions* on page 39.]

Size (Sensing distance)	Connection method	Operation mode *2	Model	
			PNP	NPN
M12 (2 mm)	Pre-wired (2 m) *1	NO	E2EW-X2B112 2M	E2EW-X2C112 2M
		NO+NC	E2EW-X2B312 2M	E2EW-X2C312 2M
	M12 Pre-wired Smartclick Connector (0.3 m)	NO	E2EW-X2B112-M1TJ 0.3M	E2EW-X2C112-M1TJ 0.3M
		NO+NC	E2EW-X2B312-M1TJ 0.3M	E2EW-X2C312-M1TJ 0.3M
M18 (5 mm)	Pre-wired (2 m) *1	NO	E2EW-X5B118 2M	E2EW-X5C118 2M
		NO+NC	E2EW-X5B318 2M	E2EW-X5C318 2M
	M12 Pre-wired Smartclick Connector (0.3 m)	NO	E2EW-X5B118-M1TJ 0.3M	E2EW-X5C118-M1TJ 0.3M
		NO+NC	E2EW-X5B318-M1TJ 0.3M	E2EW-X5C318-M1TJ 0.3M
M30 (10 mm)	Pre-wired (2 m) *1	NO	E2EW-X10B130 2M	E2EW-X10C130 2M
		NO+NC	E2EW-X10B330 2M	E2EW-X10C330 2M
	M12 Pre-wired Smartclick Connector (0.3 m)	NO	E2EW-X10B130-M1TJ 0.3M	E2EW-X10C130-M1TJ 0.3M
		NO+NC	E2EW-X10B330-M1TJ 0.3M	E2EW-X10C330-M1TJ 0.3M

*1. Models with 5-m cable length are also available with "5M" suffix. (Example: E2EW-X3B112 5M)

*2. Operation model NC are also available with "E2EW-X□□2□□". (Example: E2EW-X3B212 2M)

Note: 1. When embedding the Proximity Sensor in metal, refer to *Influence of Surrounding Metal* on page 36.

2. IO-Link is not supported for all types of BASIC Model.

BASIC Model

E2EW-Q Series (Spatter-resistant Double distance model) **NEW**

DC 3-wire [Refer to Ratings and Specifications on page 25, Dimensions on page 39.]

Size (Sensing distance)	Connection method	Operation mode *2	Model	
			PNP	NPN
M12 (3 mm)	Pre-wired (2 m) *1	NO	E2EW-QX3B112 2M	E2EW-QX3C112 2M
		NO+NC	E2EW-QX3B312 2M	E2EW-QX3C312 2M
	M12 Pre-wired Smartclick Connector (0.3 m)	NO	E2EW-QX3B112-M1TJ 0.3M	E2EW-QX3C112-M1TJ 0.3M
		NO+NC	E2EW-QX3B312-M1TJ 0.3M	E2EW-QX3C312-M1TJ 0.3M
M18 (7 mm)	Pre-wired (2 m) *1	NO	E2EW-QX7B118 2M	E2EW-QX7C118 2M
		NO+NC	E2EW-QX7B318 2M	E2EW-QX7C318 2M
	M12 Pre-wired Smartclick Connector (0.3 m)	NO	E2EW-QX7B118-M1TJ 0.3M	E2EW-QX7C118-M1TJ 0.3M
		NO+NC	E2EW-QX7B318-M1TJ 0.3M	E2EW-QX7C318-M1TJ 0.3M
M30 (12 mm)	Pre-wired (2 m) *1	NO	E2EW-QX12B130 2M	E2EW-QX12C130 2M
		NO+NC	E2EW-QX12B330 2M	E2EW-QX12C330 2M
	M12 Pre-wired Smartclick Connector (0.3 m)	NO	E2EW-QX12B130-M1TJ 0.3M	E2EW-QX12C130-M1TJ 0.3M
		NO+NC	E2EW-QX12B330-M1TJ 0.3M	E2EW-QX12C330-M1TJ 0.3M

BASIC Model

E2EW-Q Series (Spatter-resistant Single distance model)

DC 3-wire [Refer to Ratings and Specifications on page 25, Dimensions on page 39.]

Size (Sensing distance)	Connection method	Operation mode *2	Model	
			PNP	NPN
M12 (2 mm)	Pre-wired (2 m) *1	NO	E2EW-QX2B112 2M	E2EW-QX2C112 2M
		NO+NC	E2EW-QX2B312 2M	E2EW-QX2C312 2M
	M12 Pre-wired Smartclick Connector (0.3 m)	NO	E2EW-QX2B112-M1TJ 0.3M	E2EW-QX2C112-M1TJ 0.3M
		NO+NC	E2EW-QX2B312-M1TJ 0.3M	E2EW-QX2C312-M1TJ 0.3M
M18 (5 mm)	Pre-wired (2 m) *1	NO	E2EW-QX5B118 2M	E2EW-QX5C118 2M
		NO+NC	E2EW-QX5B318 2M	E2EW-QX5C318 2M
	M12 Pre-wired Smartclick Connector (0.3 m)	NO	E2EW-QX5B118-M1TJ 0.3M	E2EW-QX5C118-M1TJ 0.3M
		NO+NC	E2EW-QX5B318-M1TJ 0.3M	E2EW-QX5C318-M1TJ 0.3M
M30 (10 mm)	Pre-wired (2 m) *1	NO	E2EW-QX10B130 2M	E2EW-QX10C130 2M
		NO+NC	E2EW-QX10B330 2M	E2EW-QX10C330 2M
	M12 Pre-wired Smartclick Connector (0.3 m)	NO	E2EW-QX10B130-M1TJ 0.3M	E2EW-QX10C130-M1TJ 0.3M
		NO+NC	E2EW-QX10B330-M1TJ 0.3M	E2EW-QX10C330-M1TJ 0.3M

*1. Models with 5-m cable length are also available with "5M" suffix. (Example: E2EW-QX3B112 5M)

*2. Operation model NC are also available with "E2EW-QX□□2□□". (Example: E2EW-QX3B212 2M)

Note: 1. When embedding the Proximity Sensor in metal, refer to *Influence of Surrounding Metal* on page 36.

2. IO-Link is not supported for all types of BASIC Model.

E2EW Series

BASIC Model

E2EW Series (Double distance model) **NEW**

DC 2-wire [Refer to *Ratings and Specifications* on page 26, *Dimensions* on page 39.]

Size (Sensing distance)	Connection method	Polarity	Model	
			Operation mode: NO	Operation mode: NC
M12 (3 mm)	Pre-wired (2 m) *1	Yes	E2EW-X3D112 2M	E2EW-X3D212 2M
	M12 Pre-wired Smartclick Connector (0.3 m)	Yes	E2EW-X3D112-M1TGJ 0.3M	---
		No	E2EW-X3D112-M1TGJ-T 0.3M	---
M18 (7 mm)	Pre-wired (2 m) *1	Yes	E2EW-X7D118 2M	E2EW-X7D218 2M
	M12 Pre-wired Smartclick Connector (0.3 m)	Yes	E2EW-X7D118-M1TGJ 0.3M	---
		No	E2EW-X7D118-M1TGJ-T 0.3M	---
M30 (12 mm)	Pre-wired (2 m) *1	Yes	E2EW-X12D130 2M	E2EW-X12D230 2M
	M12 Pre-wired Smartclick Connector (0.3 m)	Yes	E2EW-X12D130-M1TGJ 0.3M	---
		No	E2EW-X12D130-M1TGJ-T 0.3M	---

BASIC Model

E2EW Series (Single distance model) **NEW**

DC 2-wire [Refer to *Ratings and Specifications* on page 26, *Dimensions* on page 39.]

Size (Sensing distance)	Connection method	Polarity	Model	
			Operation mode: NO	Operation mode: NC
M12 (2 mm)	Pre-wired (2 m) *1	Yes	E2EW-X2D112 2M	E2EW-X2D212 2M
	M12 Pre-wired Smartclick Connector (0.3 m)	Yes	E2EW-X2D112-M1TGJ 0.3M	---
		No	E2EW-X2D112-M1TGJ-T 0.3M	---
M18 (5 mm)	Pre-wired (2 m) *1	Yes	E2EW-X5D118 2M	E2EW-X5D218 2M
	M12 Pre-wired Smartclick Connector (0.3 m)	Yes	E2EW-X5D118-M1TGJ 0.3M	---
		No	E2EW-X5D118-M1TGJ-T 0.3M	---
M30 (10 mm)	Pre-wired (2 m) *1	Yes	E2EW-X10D130 2M	E2EW-X10D230 2M
	M12 Pre-wired Smartclick Connector (0.3 m)	Yes	E2EW-X10D130-M1TGJ 0.3M	---
		No	E2EW-X10D130-M1TGJ-T 0.3M	---

*1. Models with 5-m cable length are also available with "5M" suffix. (Example: E2EW-X3D112 5M)

Note: 1. When embedding the Proximity Sensor in metal, refer to *Influence of Surrounding Metal* on page 36.
2. IO-Link is not supported for BASIC Model.

BASIC Model

E2EW-Q Series (Spatter-resistant Double distance model) **NEW**

DC 2-wire [Refer to Ratings and Specifications on page 26, Dimensions on page 39.]

Size (Sensing distance)	Connection method	Polarity	Model	
			Operation mode: NO	Operation mode: NC
M12 (3 mm)	Pre-wired (2 m) *1	Yes	E2EW-QX3D112 2M	E2EW-QX3D212 2M
	M12 Pre-wired Smartclick Connector (0.3 m)	Yes	E2EW-QX3D112-M1TGJ 0.3M	---
		No	E2EW-QX3D112-M1TGJ-T 0.3M	---
M18 (7 mm)	Pre-wired (2 m) *1	Yes	E2EW-QX7D118 2M	E2EW-QX7D218 2M
	M12 Pre-wired Smartclick Connector (0.3 m)	Yes	E2EW-QX7D118-M1TGJ 0.3M	---
		No	E2EW-QX7D118-M1TGJ-T 0.3M	---
M30 (12 mm)	Pre-wired (2 m) *1	Yes	E2EW-QX12D130 2M	E2EW-QX12D230 2M
	M12 Pre-wired Smartclick Connector (0.3 m)	Yes	E2EW-QX12D130-M1TGJ 0.3M	---
		No	E2EW-QX12D130-M1TGJ-T 0.3M	---

BASIC Model

E2EW-Q Series (Spatter-resistant Single distance model) **NEW**

DC 2-wire [Refer to Ratings and Specifications on page 26, Dimensions on page 39.]

Size (Sensing distance)	Connection method	Polarity	Model	
			Operation mode: NO	Operation mode: NC
M12 (2 mm)	Pre-wired (2 m) *1	Yes	E2EW-QX2D112 2M	E2EW-QX2D212 2M
	M12 Pre-wired Smartclick Connector (0.3 m)	Yes	E2EW-QX2D112-M1TGJ 0.3M	---
		No	E2EW-QX2D112-M1TGJ-T 0.3M	---
M18 (5 mm)	Pre-wired (2 m) *1	Yes	E2EW-QX5D118 2M	E2EW-QX5D218 2M
	M12 Pre-wired Smartclick Connector (0.3 m)	Yes	E2EW-QX5D118-M1TGJ 0.3M	---
		No	E2EW-QX5D118-M1TGJ-T 0.3M	---
M30 (10 mm)	Pre-wired (2 m) *1	Yes	E2EW-QX10D130 2M	E2EW-QX10D230 2M
	M12 Pre-wired Smartclick Connector (0.3 m)	Yes	E2EW-QX10D130-M1TGJ 0.3M	---
		No	E2EW-QX10D130-M1TGJ-T 0.3M	---

*1. NO models with polarity are also available with a 5-m cable: suffix 5M (Example: E2EW-QX3D112 5M).

- Note:** 1. When embedding the Proximity Sensor in metal, refer to *Influence of Surrounding Metal* on page 36.
2. IO-Link is not supported for BASIC Model.

E2EW Series

Ratings and Specifications

PREMIUM Model

E2EW Series (Quadruple/Triple distance model)

E2EW-Q Series (Spatter-resistant Quadruple/Triple distance model)

DC 3-wire

Item	Type Size Model	Quadruple distance model			Triple distance model		
		M12	M18	M30	M12	M18	M30
		E2EW-(Q)X7□12	E2EW-(Q)X12□18	E2EW-(Q)X22□30	E2EW-(Q)X6□12	E2EW-(Q)X10□18	E2EW-(Q)X20□30
Sensing distance		7 mm ±10%	12 mm ±10%	22 mm ±10%	6 mm ±10%	10 mm ±10%	20 mm ±10%
Setting distance		0 to 4.9 mm	0 to 8.4 mm	0 to 15.4 mm	0 to 4.2 mm	0 to 7.0 mm	0 to 14 mm
Differential travel		15% max. of sensing distance					
Detectable object		Ferrous metals and non-ferrous metals (The sensing distance depends on the material of the sensing object. Refer to <i>Engineering Data</i> on page 27.)					
Standard sensing object (Iron)		21 × 21 × 1 mm	36 × 36 × 1 mm	66 × 66 × 1 mm	18 × 18 × 1 mm	30 × 30 × 1 mm	60 × 60 × 1 mm
Response frequency *1		2 Hz (Equipped with a function, which effectively cancels pulse noise of current magnetic field.)					
Power supply voltage		10 to 30 VDC (including 10% ripple (p-p)), Class 2					
Current consumption		720 mW max. (Current consumption: 30 mA max. at power supply voltage of 24 V)					
Output configuration		B□ Models: PNP open collector, C□ Models: NPN open collector					
Operation mode		1-output models (B1, C1): NO (Normally open), 1-output models (B2, C2): NC (Normally closed), 2-output models (B3, C3): NO+NC (Normally open, Normally closed)					
Control output	Load current	1-output models (B1, B2, C1, C2): 10 to 30 VDC, Class 2, 200 mA max. 2-output models (B3, C3): 10 to 30 VDC, Class 2, 100 mA max.					
	Residual voltage	1-output models (B1, B2, C1, C2): 2 V max. (Load current: 200 mA, Cable length: 2 m) 2-output models (B3, C3): 2 V max. (Load current: 100 mA, Cable length: 2 m)					
Indicator		In the Standard I/O mode (SIO mode): Operation indicator (orange, lit) and communication indicator (green, not lit) In the IO-Link communication mode (COM mode): Operation indicator (orange, lit) and communication indicator (green, blinking at 1 s intervals)					
Protection circuits		Power supply reverse polarity protection, Surge suppressor, Output short-circuit protection, Output reverse polarity protection					
Ambient temperature range		Operating: 0 to 85 °C, Storage: -15 to 85 °C (with no icing or condensation) *3					
Ambient humidity range		Operating/Storage: 35% to 95% (with no condensation)					
Temperature influence		±20% max. of sensing distance at 23 °C in the temperature range of 0 to 85 °C					
Voltage influence		±1.5% max. of sensing distance at rated voltage in the rated voltage ±15% range					
Insulation resistance		50 MΩ min. (at 500 VDC) between current-carrying parts and case					
Dielectric strength		1,000 VAC, 50/60 Hz for 1 minute between current-carrying parts and case					
Vibration resistance (destruction)		10 to 55 Hz, 1.5-mm double amplitude for 2 hours each in X, Y, and Z directions					
Shock resistance (destruction)		1,000 m/s ² 10 times each in X, Y, and Z directions					
Degree of protection		IEC 60529: IP67					
Connection method		Pre-wired Models (Standard cable length: 2 m), Pre-wired Connector Models (Standard cable length: 0.3 m), M12 Connector Models					
Weight (packed state)	Pre-wired	Approx. 140 g	Approx. 165 g	Approx. 225 g	Approx. 140 g	Approx. 165 g	Approx. 225 g
	M12 Pre-wired Smartclick Connector	Approx. 70 g	Approx. 100 g	Approx. 160 g	Approx. 70 g	Approx. 100 g	Approx. 160 g
	M12 Connector	Approx. 60 g	Approx. 75 g	Approx. 135 g	Approx. 60 g	Approx. 75 g	Approx. 135 g
Materials	Case	E2EW-X□: Stainless steel (SUS303), E2EW-QX□: Fluororesin coating (Base material: (SUS303))					
	Sensing surface	E2EW-X□: Stainless steel (SUS303), E2EW-QX□: Fluororesin coating (Base material: (SUS303))					
	Sensing surface (Thickness)	0.4 mm	0.4 mm	0.5 mm	0.4 mm	0.4 mm	0.5 mm
	Clamping nuts	E2EW-X□: Stainless steel (SUS303), E2EW-QX□: Fluororesin coating (Base material: (SUS303))					
	Toothed washers	Zinc-plated iron					
Cable	Vinyl chloride (PVC)						
Main IO-Link functions *2		Operation mode switching between NO and NC, self diagnosis enabling, excessive proximity judgment distance selecting, timer function of the control output and timer time selecting, instability output (IO-Link mode) ON delay timer time selecting function, monitor output, operating hours read-out, readout of the sensor internal temperature, and initial reset					
IO-Link Communication specifications *2	IO-Link specification	Ver.1.1					
	Baud rate	E2EW-(Q) X□B□T□: COM3 (230.4 kbps), E2EW-(Q) X□B□D□: COM2 (38.4 kbps)					
	Data length	PD size: 2 bytes, OD size: 1 byte (M-sequence type: TYPE_2_2)					
	Minimum cycle time	COM2: 2.3 ms, COM3: 1.0 ms					
Accessories		Instruction manual, Clamping nuts, Toothed washer					

*1. The response frequency is an average value. Factory setting: (timer function: ONOFF delay)

*2. IO-Link is not supported for NC-type PNP outputs or all types of NPN outputs.

*3. UL temperature rating is between 0 °C to 60 °C.

BASIC Model

E2EW Series (Double distance mode/Single distance model)

E2EW-Q Series (Spatter-resistant Double distance model/Spatter-resistant Single distance model)

DC 3-wire

Item	Type Size Model	Double distance model/ Spatter-resistant Double distance model			Single distance model/ Spatter-resistant Single distance model		
		M12	M18	M30	M12	M18	M30
		E2EW- (Q)X3□12	E2EW- (Q)X7□18	E2EW- (Q)X12□30	E2EW- (Q)X2□12	E2EW- (Q)X5□18	E2EW- (Q)X10□30
Sensing distance		3 mm ±10%	7 mm ±10%	12 mm ±10%	2 mm ±10%	5 mm ±10%	10 mm ±10%
Setting distance		0 to 2.1 mm	0 to 4.9 mm	0 to 8.4 mm	0 to 1.4 mm	0 to 3.5 mm	0 to 7 mm
Differential travel		15% max. of sensing distance			10% max. of sensing distance		
Detectable object		Ferrous metals and non-ferrous metals (The sensing distance depends on the material of the sensing object. Refer to <i>Engineering Data</i> on page 27.)					
Standard sensing object (Iron)		21 × 21 × 1 mm	30 × 30 × 1 mm	54 × 54 × 1 mm	12 × 12 × 1 mm	18 × 18 × 1 mm	30 × 30 × 1 mm
Response frequency *1		80 Hz	90 Hz	50 Hz	100 Hz	80 Hz	40 Hz
Power supply voltage		10 to 30 VDC (including 10% ripple (p-p)), Class 2					
Current consumption		1-output models (B1, B2, C1, C2): 16 mA max. 2-output models (B3, C3): 20 mA max.					
Output configuration		B□ Models: PNP open collector, C□ Models: NPN open collector					
Operation mode		1-output models (B1, C1): NO (Normally open), 1-output models (B2, C2): NC (Normally closed), 2-output models (B3, C3): NO+NC (Normally open, Normally closed)					
Control output	Load current	1-output models (B1, B2, C1, C2): 10 to 30 VDC, Class 2, 200 mA max. 2-output models (B3, C3): 10 to 30 VDC, Class 2, 100 mA max.					
	Residual voltage	1-output models (B1, B2, C1, C2): 2 V max. (Load current: 200 mA, Cable length: 2 m) 2-output models (B3, C3): 2 V max. (Load current: 100 mA, Cable length: 2 m)					
Indicator		Operation indicator (orange, lit) and communication indicator (green, not lit)					
Protection circuits		Power supply reverse polarity protection, Surge suppressor, Output short-circuit protection, Output reverse polarity protection					
Ambient temperature range		Operating: 0 to 85 °C, Storage: -15 to 85 °C (with no icing or condensation) *2					
Ambient humidity range		Operating/Storage: 35% to 95% (with no condensation)					
Temperature influence		±20% max. of sensing distance at 23 °C in the temperature range of 0 to 85 °C					
Voltage influence		±1.5% max. of sensing distance at rated voltage in the rated voltage ±15% range					
Insulation resistance		50 MΩ min. (at 500 VDC) between current-carrying parts and case					
Dielectric strength		1,000 VAC, 50/60 Hz for 1 minute between current-carrying parts and case					
Vibration resistance (destruction)		10 to 55 Hz, 1.5-mm double amplitude for 2 hours each in X, Y, and Z directions					
Shock resistance (destruction)		1,000 m/s ² 10 times each in X, Y, and Z directions					
Degree of protection		IEC 60529: IP67					
Connection method		Pre-wired Models (Standard cable length: 2 m), Pre-wired Connector Models (Standard cable length: 0.3 m)					
Weight (packed state)	Pre-wired	Approx. 140 g	Approx. 165 g	Approx. 225 g	Approx. 140 g	Approx. 160 g	Approx. 225 g
	M12 Pre-wired Smartclick Connector	Approx. 70 g	Approx. 100 g	Approx. 160 g	Approx. 70 g	Approx. 95 g	Approx. 160 g
Materials	Case	E2EW-X□: Stainless steel (SUS303), E2EW-QX□: Fluororesin coating (Base material: (SUS303))					
	Sensing surface	E2EW-X□: Stainless steel (SUS303), E2EW-QX□: Fluororesin coating (Base material: (SUS303))					
	Sensing surface (Thickness)	0.4 mm	0.4 mm	0.5 mm	0.8 mm	0.8 mm	0.8 mm
	Clamping nuts	E2EW-X□: Stainless steel (SUS303), E2EW-QX□: Fluororesin coating (Base material: (SUS303))					
	Toothed washers	Zinc-plated iron					
Cable		Vinyl chloride (PVC)					
Accessories		Instruction manual, Clamping nuts, Toothed washer					

*1. The response frequency is an average value. Measurement conditions are as follows: standard sensing object, a distance of twice the standard sensing object, and a set distance of half the sensing distance.

*2. UL temperature rating is between 0 °C to 60 °C.

E2EW Series

BASIC Model

E2EW Series (Double distance model/Single distance model)

E2EW-Q Series (Spatter-resistant Double distance model/Spatter-resistant Single distance model)

DC 2-wire

Item	Type	Double distance model/ Spatter-resistant Double distance model			Single distance model/ Spatter-resistant Single distance model		
	Size	M12	M18	M30	M12	M18	M30
	Model	E2EW- (Q)X3D□12	E2EW- (Q)X7D□18	E2EW- (Q)X12D□30	E2EW- (Q)X2D□12	E2EW- (Q)X5D□18	E2EW- (Q)X10D□30
Sensing distance		3 mm ±10%	7 mm ±10%	12 mm ±10%	2 mm ±10%	5 mm ±10%	10 mm ±10%
Setting distance		0 to 2.1 mm	0 to 4.9 mm	0 to 8.4 mm	0 to 1.4 mm	0 to 3.5 mm	0 to 7 mm
Differential travel		15% max. of sensing distance			10% max. of sensing distance		
Detectable object		Ferrous metals and non-ferrous metals (The sensing distance depends on the material of the sensing object. Refer to <i>Engineering Data</i> on page 27.)					
Standard sensing object (Iron)		21 × 21 × 1 mm	30 × 30 × 1 mm	54 × 54 × 1 mm	12 × 12 × 1 mm	18 × 18 × 1 mm	30 × 30 × 1 mm
Response frequency *1		80 Hz	90 Hz	50 Hz	100 Hz	80 Hz	40 Hz
Power supply voltage		10 to 30 VDC (including 10% ripple (p-p)), Class 2					
Leakage current		0.8 mA max.					
Output configuration		□ models: Polarity D1-T models: No polarity					
Operation mode		D1 models: NO (Normally open), D2 models: NC (Normally closed)					
Control output	Load current	3 to 100 mA					
	Residual voltage	Polarity: 3 V max. (Load current: 100 mA, Cable length: 2 m) No polarity: 5 V max. (Load current: 100 mA, Cable length: 2 m)					
Indicator		D1 models: Operation indicator (orange, lit) and communication indicator (green, not lit) D2 models: Operation indicator (orange, lit)					
Protection circuits		Surge suppressor, Output short-circuit protection					
Ambient temperature range		Operating: 0 to 85 °C, Storage: -15 to 85 °C (with no icing or condensation) *2					
Ambient humidity range		Operating/Storage: 35% to 95% (with no condensation)					
Temperature influence		±20% max. of sensing distance at 23 °C in the temperature range of 0 to 85 °C					
Voltage influence		±1.5% max. of sensing distance at rated voltage in the rated voltage ±15% range					
Insulation resistance		50 MΩ min. (at 500 VDC) between current-carrying parts and case					
Dielectric strength		1,000 VAC, 50/60 Hz for 1 minute between current-carrying parts and case					
Vibration resistance (destruction)		10 to 55 Hz, 1.5-mm double amplitude for 2 hours each in X, Y, and Z directions					
Shock resistance (destruction)		1,000 m/s ² 10 times each in X, Y, and Z directions					
Degree of protection		IEC 60529: IP67					
Connection method		Pre-wired Models (Standard cable length: 2 m), Pre-wired Connector Models (Standard cable length: 0.3 m)					
Weight (packed state)	Pre-wired	Approx. 140 g	Approx. 165 g	Approx. 225 g	Approx. 140 g	Approx. 160 g	Approx. 225 g
	M12 Pre-wired Smartclick Connector	Approx. 70 g	Approx. 100 g	Approx. 160 g	Approx. 70 g	Approx. 95 g	Approx. 160 g
Materials	Case	E2EW-X□: Stainless steel (SUS303), E2EW-QX□: Fluororesin coating (Base material: (SUS303))					
	Sensing surface	E2EW-X□: Stainless steel (SUS303), E2EW-QX□: Fluororesin coating (Base material: (SUS303))					
	Sensing surface (Thickness)	0.4 mm	0.4 mm	0.5 mm	0.8 mm	0.8 mm	0.8 mm
	Clamping nuts	E2EW-X□: Stainless steel (SUS303), E2EW-QX□: Fluororesin coating (Base material: (SUS303))					
	Toothed washers	Zinc-plated iron					
Cable	Vinyl chloride (PVC)						
Accessories		Instruction manual, Clamping nuts, Toothed washer					

*1. The response frequency is an average value. Measurement conditions are as follows: standard sensing object, a distance of twice the standard sensing object, and a set distance of half the sensing distance.

*2. UL temperature rating is between 0 °C to 60 °C.

Engineering Data (Reference Value)

Sensing Area

PREMIUM Model

**DC 3-wire
 Quadruple distance model/
 Spatter-resistant Quadruple distance model**
 Sensing object: iron

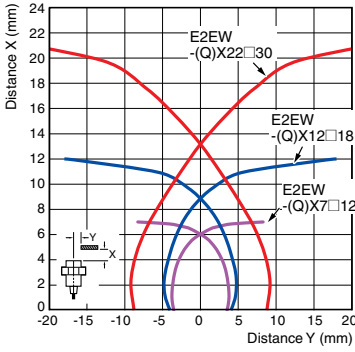

Sensing object: Aluminum



**DC 3-wire
 Triple distance model/
 Spatter-resistant Triple distance model**
 Sensing object: iron



Sensing object: Aluminum



BASIC Model

**DC 2-wire/DC 3-wire
 Double distance model/
 Spatter-resistant Double distance model**
 Sensing object: iron

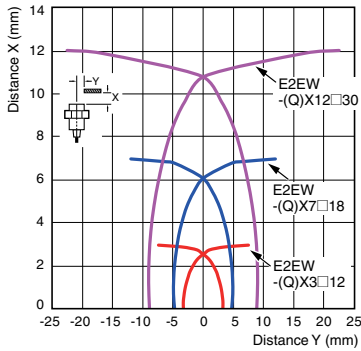

**DC 2-wire/DC 3-wire
 Single distance model/
 Spatter-resistant Single distance model**
 Sensing object: iron

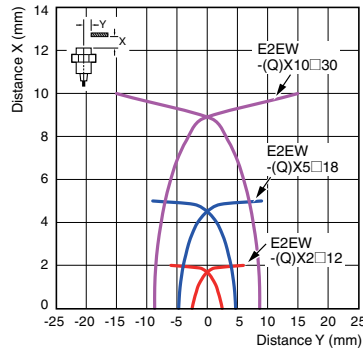

Influence of Sensing Object Size and Material

PREMIUM Model

**DC 3-wire
Quadruple distance model/
Spatter-resistant
Quadruple distance model**

Size: M12
E2EW-(Q)X7□12



Size: M18
E2EW-(Q)X12□18



Size: M30
E2EW-(Q)X22□30



BASIC Model

**DC 2-wire/DC 3-wire
Double distance model/
Spatter-resistant
Double distance model**

Size: M12
E2EW-(Q)X3□12

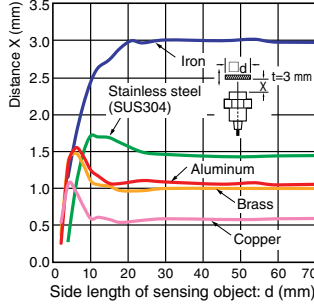

Size: M18
E2EW-(Q)X7□18

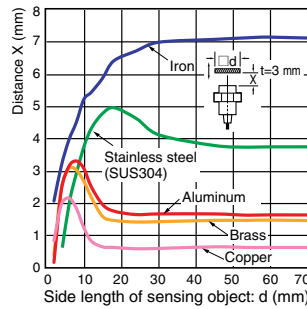

Size: M30
E2EW-(Q)X12□30

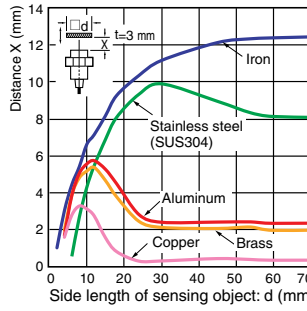

**DC 2-wire/DC 3-wire
Single distance model/
Spatter-resistant
Single distance model**

Size: M12
E2EW-(Q)X2□12

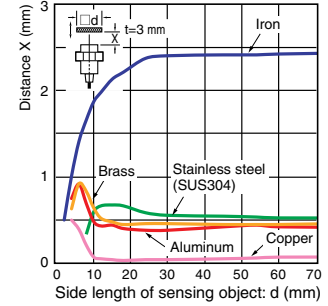

Size: M18
E2EW-(Q)X5□18

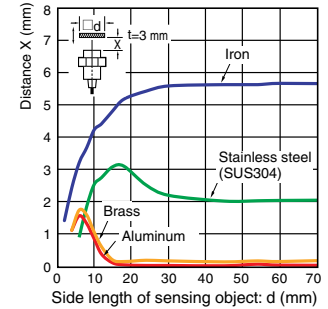

Size: M30
E2EW-(Q)X10□30

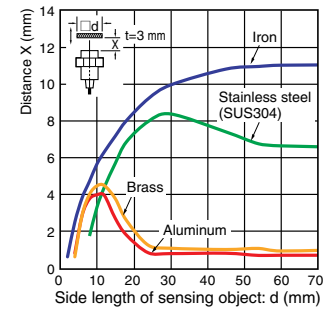

Influence of Sensing Object Thickness and Material

PREMIUM Model

DC 3-wire
 Quadruple distance model/
 Spatter-resistant
 Quadruple distance model

Size: M12
 E2EW-(Q)X7□12



Size: M18
 E2EW-(Q)X12□18



Size: M30
 E2EW-(Q)X22□30



DC 3-wire
 Triple distance model/
 Spatter-resistant
 Triple distance model

Size: M12
 E2EW-(Q)X6□12

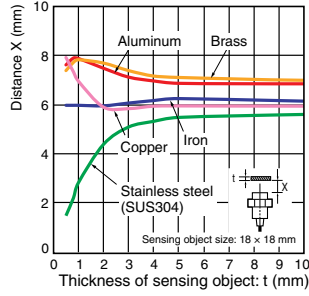

Size: M18
 E2EW-(Q)X10□18

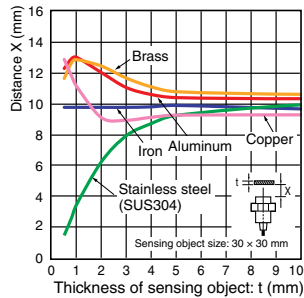

Size: M30
 E2EW-(Q)X20□30

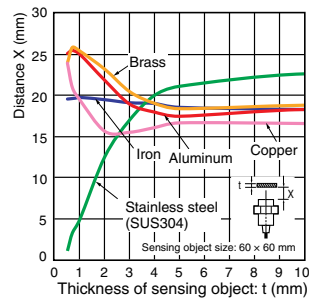

BASIC Model

DC 2-wire/DC 3-wire
 Double distance model/
 Spatter-resistant
 Double distance model

Size: M12
 E2EW-(Q)X3□12

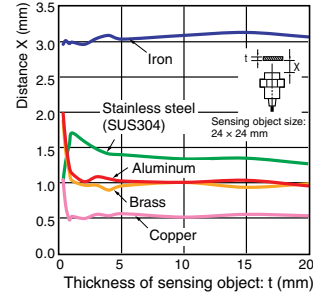

Size: M18
 E2EW-(Q)X7□18

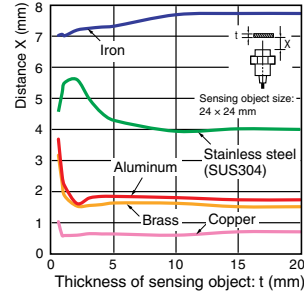

Size: M30
 E2EW-(Q)X12□30

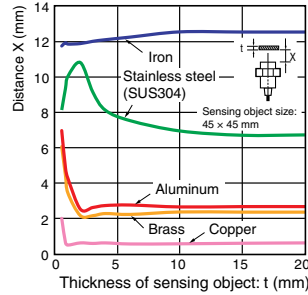

DC 2-wire/DC 3-wire
 Single distance model/
 Spatter-resistant
 Single distance model

Size: M12
 E2EW-(Q)X2□12



Size: M18
 E2EW-(Q)X5□18

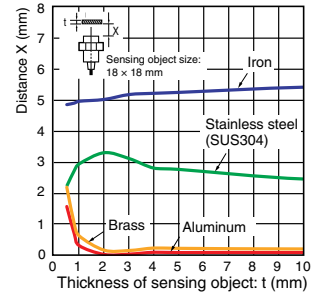

Size: M30
 E2EW-(Q)X10□30

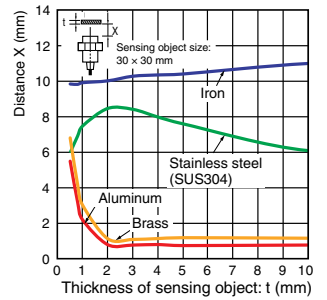

E2EW Series

Monitor Output vs. Sensing Distance

PREMIUM Model

DC 3-wire

Quadruple distance model/Spatter-resistant Quadruple distance model

Size: M12
E2EW-(Q)X7□12

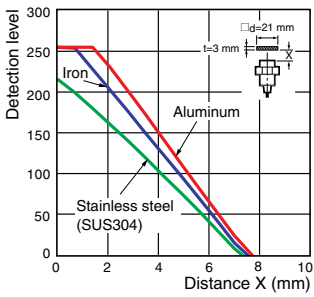

Size: M18
E2EW-(Q)X12□18



Size: M30
E2EW-(Q)X22□30



DC 3-wire

Triple distance model/Spatter-resistant Triple distance model

Size: M12
E2EW-(Q)X6□12

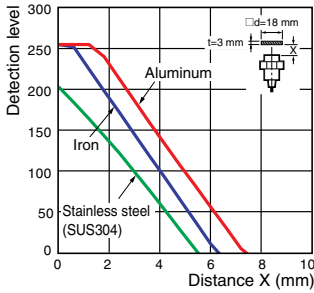

Size: M18
E2EW-(Q)X10□18



Size: M30
E2EW-(Q)X20□30



I/O Circuit Diagrams/Timing charts

DC 3-wire

PNP output (PREMIUM Model) [Refer to *Timing Chart* on page 32]

Operation mode	Model	Output circuit	
		Standard I/O mode (SIO mode) When using as a general	IO-Link Communication mode (COM mode) When using the Sensor connected to IO-Link Master Unit
NO	E2EW-(Q)X□B1		
NC	E2EW-(Q)X□B2		---
NO+NC	E2EW-(Q)X□B3		

In the IO-Link mode, the cord between the IO-Link master and sensor must have a length of 20 m or less.

NPN output (PREMIUM Model)

Operation mode	Model	Timing chart	Output circuit
NO	E2EW-(Q)X□C1		
NC	E2EW-(Q)X□C2		
NO+NC	E2EW-(Q)X□C3		

Connector Pin Arrangement

M12 Connector M12 Smartclick Connector	
---	--

DC 3-wire

PNP output (PREMIUM Model)



*3. The timer function of the control output can be set up by the IO-Link communications. (It is able to select ON delay, OFF delay, one-shot, or ONOFF delay function and select a timer time of 1 to 16,383ms (T).)



*4. The excessive proximity diagnosis function can be selected by the IO-Link communications.

*5. The instability detection diagnosis can be selected by the IO-Link communications.

*6. The judgment time for the instability detection diagnosis can be selected by the IO-Link communications. (For the ON delay timer function, the setting can be selected from 0 (invalid), 10, 50, 100, 300, 500, or 1000 ms.)

*7. The judgment distance of the excessive proximity diagnosis function can be selected by the IO-Link communications. (The distance can be selected as a combination of the material of the object detected, such as iron, aluminum, or SUS and the judgment distance of approximately 10, 20, or 30%. However, it is not allowed to select a combination of aluminum and 10%.)

Please contact your OMRON sales representative regarding the IO-Link setup file (IODD file).

Please contact your OMRON sales representative regarding assignment of data.

*1. For models with IO-Link, the operation mode can be changed by the IO-Link communications.

*2. If using a model with IO-Link as a general sensor or using a model without IO-Link, it operates in the standard I/O mode (SIO mode).

DC 3-wire

PNP output (BASIC Model)

Operation mode	Model	Timing chart	Output circuit
NO	E2EW-(Q)X□B1	<p>Proximity Sensor</p> <p>Rated Sensing distance (%)</p> <p>ON Operation indicator OFF (orange) ON Control output OFF</p>	<p>10 to 30 VDC Brown (1) +V Black (4) OUT Blue (3) 0V</p>
NC	E2EW-(Q)X□B2	<p>Proximity Sensor</p> <p>Rated Sensing distance (%)</p> <p>ON Operation indicator OFF (orange) ON Control output OFF</p>	<p>10 to 30 VDC Brown (1) +V Black (2) OUT Blue (3) 0V</p>
NO+NC	E2EW-(Q)X□B3	<p>Proximity Sensor</p> <p>Rated Sensing distance (%)</p> <p>ON Operation indicator OFF (orange) ON Control output 1 ON Control output 2 OFF</p>	<p>10 to 30 VDC Brown (1) +V Black (4) OUT1 White (2) OUT2 Blue (3) 0V</p>

NPN output (BASIC Model)

Operation mode	Model	Timing chart	Output circuit
NO	E2EW-(Q)X□C1	<p>Proximity Sensor</p> <p>Rated Sensing distance (%)</p> <p>ON Operation indicator OFF (orange) ON Control output OFF</p>	<p>10 to 30 VDC Brown (1) +V Black (4) OUT Blue (3) 0V</p>
NC	E2EW-(Q)X□C2	<p>Proximity Sensor</p> <p>Rated Sensing distance (%)</p> <p>ON Operation indicator OFF (orange) ON Control output OFF</p>	<p>10 to 30 VDC Brown (1) +V Black (2) OUT Blue (3) 0V</p>
NO+NC	E2EW-(Q)X□C3	<p>Proximity Sensor</p> <p>Rated Sensing distance (%)</p> <p>ON Operation indicator OFF (orange) ON Control output 1 ON Control output 2 OFF</p>	<p>10 to 30 VDC Brown (1) +V Black (4) OUT1 White (2) OUT2 Blue (3) 0V</p>

Connector Pin Arrangement



E2EW Series

DC 2-wire

BASIC Models

Operation mode	Model	Timing chart	Output circuit
NO	E2EW-(Q)X□D1□	<p>The timing chart shows a sensing object moving from left to right. The sensing area is divided into 'Nonsensing area', 'Unstable sensing area', and 'Stable Sensing area'. The 'Set position' is marked at the start of the stable area. The x-axis represents distance from 100% (Rated Sensing distance) to 0%. The y-axis shows the state of the Setting indicator (green), Operation indicator (orange), and Control output.</p>	<p>The output circuit shows a PNP transistor switching a load between the Brown (+V) and Blue (0V) lines. The load is connected to the Brown line.</p> <p>Connector Pin Arrangement: Note: Pins 2 and 3 are not used.</p> <p>Note: The load can be connected to either the +V or 0 V side.</p>
	E2EW-(Q)X□D1□-T	<p>The timing chart is similar to the first model but includes a 'Control output' signal. The x-axis shows the 'Rated Sensing distance' and the y-axis shows the states of the Setting indicator (green), Operation indicator (orange), and Control output.</p>	<p>The output circuit is similar to the first model but includes a diode in parallel with the load. The load is connected to the Blue (0V) line.</p> <p>Connector Pin Arrangement: Note: Pins 1 and 2 are not used.</p> <p>Note 1. The load can be connected to either the +V or 0 V side. Note 2. The E2E-X□D1-M1J-T has no polarity. Therefore, terminals 3 and 4 have no polarity.</p>
NC	E2EW-(Q)X□D2□	<p>The timing chart shows a sensing object moving from left to right. The sensing area is divided into 'Nonsensing area' and 'Sensing area'. The x-axis represents distance from 100% (Rated Sensing distance) to 0%. The y-axis shows the states of the Operation indicator (orange) and Control output.</p>	<p>The output circuit shows an NPN transistor switching a load between the Brown (+V) and Blue (0V) lines. The load is connected to the Blue line.</p> <p>Connector Pin Arrangement: Note: Pins 3 and 4 are not used.</p> <p>Note: The load can be connected to either the +V or 0 V side.</p>

Safety Precautions

Be sure to read the precautions for all models in the website at: <http://www.ia.omron.com/>.

Warning Indications

⚠ WARNING	Warning level Indicates a potentially hazardous situation which, if not avoided, will result in minor or moderate injury, or may result in serious injury or death. Additionally there may be significant property damage.
Precautions for Safe Use	Supplementary comments on what to do or avoid doing, to use the product safely.
Precautions for Correct Use	Supplementary comments on what to do or avoid doing, to prevent failure to operate, malfunction or undesirable effect on product performance.

Meaning of Product Safety Symbols

	General prohibition Indicates the instructions of unspecified prohibited action.
	Caution, explosion Indicates the possibility of explosion under specific conditions.

⚠ WARNING

This product is not designed or rated for ensuring safety of persons either directly or indirectly. Do not use it for such purposes.



Otherwise, explosion may result. Never use the product with an AC power supply.



Precautions for Safe Use

The following precautions must be observed to ensure safe operation.

1. Do not use the product in environments subject to flammable or explosive gases.
2. Do not attempt to disassemble, repair, or modify the product.
3. Do not use a voltage that exceeds the rated operating voltage range.
Applying a voltage that is higher than the operating voltage range may result in explosion or fire.
4. Be sure that the power supply polarity and other wiring is correct. Incorrect wiring may cause explosion or fire.
5. If the power supply is connected directly without a load, the internal elements may explode or burn.
6.  Dispose of the product according to applicable regulations (laws).

Precautions for Correct Use

Do not use the product in any atmosphere or environment that exceeds the ratings.

Operating Environment

1. Do not install the Sensor in the following locations.
 - (1) Outdoor locations directly subject to sunlight, rain, snow, water droplets, or oil.
 - (2) Locations subject to atmospheres with chemical vapors, in particular solvents and acids.
 - (3) Locations subject to corrosive gases.
2. The Sensor may malfunction if used near ultrasonic cleaning equipment, high-frequency equipment, transceivers, cellular phones, inverters, or other devices that generate a high-frequency electric field. Please refer to the Precautions for Correct Use on the OMRON website (www.ia.omron.com) for typical measures.
3. Laying the Proximity Sensor wiring in the same conduit or duct as high-voltage wires or power lines may result in incorrect operation and damage due to induction. Wire the Sensor using a separate conduit or independent conduit.
4. Never use thinner or other solvents. Otherwise, the Sensor surface may be dissolved.
5. When turning on the power by influence of temperature environment, an output mis-pulse sometimes occurs. After the sensor has passed for 300 msec after turning on, please use in the stable state.
6. The sensor is adjusted with a high degree of accuracy, so do not use in the environment with sudden temperature change.
7. Operation check is performed using an OMRON's IO-Link master. If using an IO-Link master from another company, perform the operation check in advance. (Models with IO-Link only.)
8. When connecting non IO-Link compliant models to the IO-Link master, use the SIO mode.
9. In the IO-Link mode, the cord between the IO-Link master and sensor must have a length of 20 m or less. (Models with IO-Link only.)
10. The Sensor cannot be used embedded in where pressure is constantly applied to the sensing surface, such as hydraulic cylinders and hydraulic valves.

E2EW Series

Design

Influence of Surrounding Metal

When mounting the Proximity Sensor, ensure that the minimum distances given in the following table are maintained. If you use a nut, only use the provided nut. And ensure that the minimum distances between the sensing surface and nut is bigger than the "L" given in the following table. Other non-ferrous metals affect sensor's performance in the same way as aluminum. Perform the operation check in advance.



(Unit: mm)

Mounting panel material: Iron

Models	Model	L	d	D	m	n
Quadruple distance model	E2EW-(Q)X7□12	4	30	4	28	36
	E2EW-(Q)X12□18	6	54	6	36	54
	E2EW-(Q)X22□30	8	90	8	66	90
Triple distance model	E2EW-(Q)X6□12	4	30	4	24	36
	E2EW-(Q)X10□18	2	54	2	30	54
	E2EW-(Q)X20□30	0	30	0	60	90
Double distance model	E2EW-(Q)X3□12	0	12	0	12	40
	E2EW-(Q)X7□18	0	18	0	28	60
	E2EW-(Q)X12□30	0	30	0	48	100
Single distance model	E2EW-(Q)X2□12	0	12	0	8	40
	E2EW-(Q)X5□18	0	18	0	20	60
	E2EW-(Q)X10□30	0	30	0	40	100

Mounting panel material: Aluminum

Models	Model	L	d	D	m	n
Quadruple distance model	E2EW-(Q)X7□12	12	70	12	28	70
	E2EW-(Q)X12□18	12	80	12	36	80
	E2EW-(Q)X22□30 *1	16	120	16	66	120
Triple distance model	E2EW-(Q)X6□12	12	70	12	24	70
	E2EW-(Q)X10□18	12	80	12	30	80
	E2EW-(Q)X20□30 *1	16	120	16	60	120
Double distance model	E2EW-(Q)X3□12	12	70	12	12	70
	E2EW-(Q)X7□18	12	80	12	28	80
	E2EW-(Q)X12□30	16	120	16	48	120
Single distance model	E2EW-(Q)X2□12	12	70	12	8	70
	E2EW-(Q)X5□18	12	80	12	20	80
	E2EW-(Q)X10□30	16	120	16	40	120

*1. If you use the model E2EW-(Q)X22□30, or E2EW-(Q)X20□30, the panel thickness (t) is 3 mm or less.

When the Proximity Sensor is mounted in metal, ensure that the minimum distances given in the following table are maintained.



(Unit: mm)

Embedded material: Iron

Models	Model	l	d	D	m	n
Quadruple distance model	E2EW-(Q)X7□12	4	30	4	28	36
	E2EW-(Q)X12□18	6	54	6	36	54
	E2EW-(Q)X22□30	8	90	8	66	90
Triple distance model	E2EW-(Q)X6□12	0 *2	12 *2	0 *2	24	36
	E2EW-(Q)X10□18	0	18	0	30	54
	E2EW-(Q)X20□30	0	30	0	60	90
Double distance model	E2EW-(Q)X3□12	0	12	0	12	40
	E2EW-(Q)X7□18	0	18	0	28	60
	E2EW-(Q)X12□30	0	30	0	48	100
Single distance model	E2EW-(Q)X2□12	0	12	0	8	40
	E2EW-(Q)X5□18	0	18	0	20	60
	E2EW-(Q)X10□30	0	30	0	40	100

*2. If the thickness of the mounting bracket (t) is less than 10 mm, be sure to install the Sensor so that $l \geq 2$, $d \text{ (dia.)} \geq 30$, and $D \geq 2$.

Embedded material: Aluminum

Models	Model	l	d	D	m	n
Quadruple distance model	E2EW-(Q)X7□12	12	70	12	28	70
	E2EW-(Q)X12□18	12	80	12	36	80
	E2EW-(Q)X22□30	16	120	16	66	120
Triple distance model	E2EW-(Q)X6□12	12	70	12	24	70
	E2EW-(Q)X10□18	12	80	12	30	80
	E2EW-(Q)X20□30	16	120	16	60	120
Double distance model	E2EW-(Q)X3□12	12	70	12	12	70
	E2EW-(Q)X7□18	12	80	12	28	80
	E2EW-(Q)X12□30	16	120	16	48	120
Single distance model	E2EW-(Q)X2□12	12	70	12	8	70
	E2EW-(Q)X5□18	12	80	12	20	80
	E2EW-(Q)X10□30	16	120	16	40	120

Mutual Interference

When installing two or more Proximity Sensors face-to-face or side-by-side, ensure that the minimum distances given in the following table are maintained.



(Unit: mm)

Models	Model	Item	
		A	B
Quadruple distance model	E2EW-(Q)X7□12	45	40
	E2EW-(Q)X12□18	80	60
	E2EW-(Q)X22□30	135	110
Triple distance model	E2EW-(Q)X6□12	45	40
	E2EW-(Q)X10□18	80	60
	E2EW-(Q)X20□30	135	110
Double distance model	E2EW-(Q)X3□12	40	35
	E2EW-(Q)X7□18	65	60
	E2EW-(Q)X12□30	110	100
Single distance model	E2EW-(Q)X2□12	40	35
	E2EW-(Q)X5□18	65	60
	E2EW-(Q)X10□30	110	100

Chips from Cutting Aluminum

Normally, chips from cutting aluminum will not cause a detection signal to be output even if it adheres to or accumulates on the detection surface. In the following cases, however, a detection signal may be output.

Remove the cutting chips in these cases.

- If $d \geq 2/3D$ at the center of the detection surface where d is the cutting chip size and D is the detection surface size

(Unit: mm)

Model	Dimension	D
E2EW-(Q)X□12		10
E2EW-(Q)X□18		16
E2EW-(Q)X□30		28

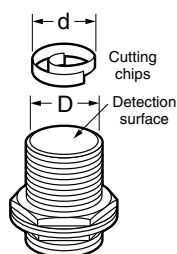

- If the cutting chips are pressed down

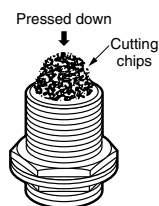

Mounting

Tightening Force

Do not tighten the nut with excessive force.

A washer must be used with the nut.

The tightening force must be the same or less than the figures in the following table.



Quadruple distance model, Triple distance model (Unit: N·m)

Size	Torque
M12	20 (15)
M18	70 (35)
M30	180 (60)

* Tighten the nut of the E2EW-Q to a torque in parentheses.

Double distance model, Single distance model (Unit: N·m)

Size	Torque
M12	30 (15)
M18	70 (35)
M30	180 (60)

* Tighten the nut of the E2EW-Q to a torque in parentheses.

Note: When mounting the Proximity Sensor, only use the provided nut. Do not use set screws. The Sensor may malfunction.

E2EW Series

Dimensions

(Unit: mm)
Tolerance class IT16 applies to dimensions in this data sheet unless otherwise specified.

Sensors

PREMIUM Model DC 3-wire

E2EW/E2EW-Q Series (Quadruple distance/Triple distance/ Spatter-resistant Quadruple distance, Spatter-resistant Triple distance model)

Pre-wired Model/
Pre-wired Connector Model



M12 Connector Model



Pre-wired Model

Pre-wired Connector Model
(M1TJ)



(Operation mode): Output configuration (B1, C1): NO,
(B2, C2): NC

Vinyl-insulated round cable with 3 conductors size: 6-dia.
(Conductor cross section: 0.3 mm² (AWG24), Insulator diameter: 1.05 mm),
Standard length: 2 m (Pre-wired Model), 0.3 m (Pre-wired Connector Model)

(Operation mode): Output configuration (B3, C3): NO+NC
Vinyl-insulated round cable with 4 conductors size: 6-dia.
(Conductor cross section: 0.3 mm² (AWG24), Insulator diameter: 1.05 mm),
Standard length: 2 m (Pre-wired Model), 0.3 m (Pre-wired Connector Model)

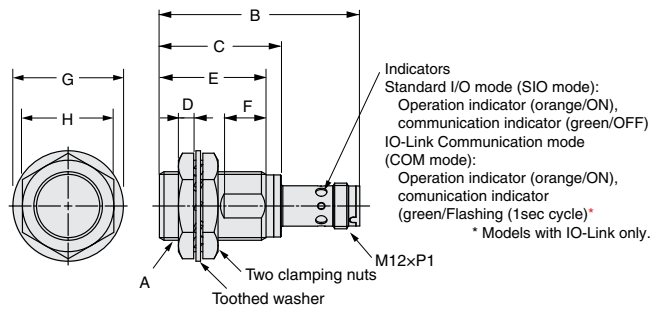

Models	Model	A	B	C	D	E	F	G	H
Quadruple distance model	E2EW-(Q) X7□12-M1	M12xP1	54.4	---	4	28	8	21 dia.	17
	E2EW-(Q) X12□18-M1	M18xP1	54.4	32	4	28	11	29 dia.	24
	E2EW-(Q) X22□30-M1	M30xP1.5	54.4	32	5	28	11	42 dia.	36
Triple distance model	E2EW-(Q) X6□12-M1	M12xP1	54.4	---	4	28	8	21 dia.	17
	E2EW-(Q) X10□18-M1	M18xP1	54.4	32	4	28	11	29 dia.	24
	E2EW-(Q) X20□30-M1	M30xP1.5	54.4	32	5	28	11	42 dia.	36

Models	Model	A	B	C	D	E	F	G
Quadruple distance model	E2EW-(Q)X7□12(-M1TJ)	M12xP1	41.5	30	4	10	21 dia.	17
	E2EW-(Q)X12□18(-M1TJ)	M18xP1	41.5	30	4	13	29 dia.	24
	E2EW-(Q)X22□30(-M1TJ)	M30xP1.5	41.5	30	5	13	42 dia.	36
Triple distance model	E2EW-(Q)X6□12(-M1TJ)	M12xP1	41.5	30	4	10	21 dia.	17
	E2EW-(Q)X10□18(-M1TJ)	M18xP1	41.5	30	4	13	29 dia.	24
	E2EW-(Q)X20□30(-M1TJ)	M30xP1.5	41.5	30	5	13	42 dia.	36

Mounting Hole Dimensions



Dimensions	F (mm)
M12	12.5 dia. $^{+0.5}_0$
M18	18.5 dia. $^{+0.5}_0$
M30	30.5 dia. $^{+0.5}_0$

Angle R of the Bending Wire

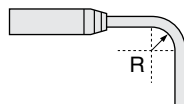

Dimensions	R (mm)
M12	18
M18	
M30	

Dimensions

Sensors

BASIC Model DC 2-wire/DC 3-wire

E2EW/E2EW-Q Series (Double distance model/Spatter-resistant Double distance model/Single distance model/Spatter-resistant Single distance model)

Pre-wired Model/
Pre-wired Connector Model



Pre-wired Model

Pre-wired Connector Model (M12J/M1TGJ)



(Operation mode): Output configuration (D1): NO
(D2): NC

Vinyl-insulated round cable with 2 conductors size: 6-dia.
(Conductor cross section: 0.3 mm² (AWG24), Insulator diameter: 1.05 mm),
Standard length: 2 m (Pre-wired Model), 0.3 m (Pre-wired Connector Model)

(Operation mode): Output configuration (B1/C1): NO
(B2/C2): NC

Vinyl-insulated round cable with 3 conductors size: 6-dia.
(Conductor cross section: 0.3 mm² (AWG24), Insulator diameter: 1.05 mm),
Standard length: 2 m (Pre-wired Model), 0.3 m (Pre-wired Connector Model)

(Operation mode): Output configuration (B3/C3): NO+NC
Vinyl-insulated round cable with 4 conductors size: 6-dia.
(Conductor cross section: 0.3 mm² (AWG24), Insulator diameter: 1.05 mm),
Standard length: 2 m (Pre-wired Model), 0.3 m (Pre-wired Connector Model)

Models	Model	A	B	C	D	E	F	G	
Double distance model	E2EW-(Q)X3 □12(-M1TJ) E2EW-(Q)X3D □12(-M1TGJ)	M12×P1	41.5	30	4	10	21 dia.	17	
	E2EW-(Q)X7 □18(-M1TJ) E2EW-(Q)X7D □18(-M1TGJ)	M18×P1	41.5	30	4	13	29 dia.	24	
	E2EW-(Q)X12 □30(-M1TJ) E2EW-(Q)X12D □30(-M1TGJ)	M30×P1.5	41.5	30	5	13	42 dia.	36	
	Single distance model	E2EW-(Q)X2 □12(-M1TJ) E2EW-(Q)X2D □12(-M1TGJ)	M12×P1	41.9	30.4	4	7	21 dia.	17
		E2EW-(Q)X5 □18(-M1TJ) E2EW-(Q)X5D □18(-M1TGJ)	M18×P1	41.9	30.4	4	10	29 dia.	24
		E2EW-(Q)X10 □30(-M1TJ) E2EW-(Q)X10D □30(-M1TGJ)	M30×P1.5	41.8	30.3	5	10	42 dia.	36

Mounting Hole Dimensions

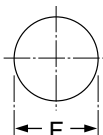

Dimensions	F (mm)
M12	12.5 dia. ^{+0.5} / ₀
M18	18.5 dia. ^{+0.5} / ₀
M30	30.5 dia. ^{+0.5} / ₀

Angle R of the Bending Wire

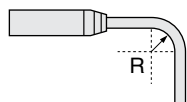

Dimensions	R (mm)
M12	18
M18	
M30	

Round Water-resistant Connectors (M12 Smartclick)

XS5

Round Water-resistive Smartclick Connectors that Reduce Installation Work

- A newly developed lock mechanism that is compatible with round M12 connectors.
- Simply insert the Connectors, then turn them approximately 1/8 of a turn to lock.
- A positive click indicates locking.
- Spatter-resistant Cables are also available.
- IP67 degree of protection.
- UL approved products.



For the most recent information on models that have been certified for safety standards, refer to your OMRON website.

Note: For details, refer to XS5 on your OMRON website.

Ordering Information

Sensor I/O Connectors

A Sensor I/O Connector is not provided with the Sensor. It must be ordered separately as required.

Appearance	Cable Specification	Type	Cable diameter (mm)	Cable Connection Direction	Cable length (m)	Sensor I/O Connector model number	Applicable Proximity Sensor model number
M12 Smartclick Connector Straight type  Right-angle type 	PVC robot cable	Sockets on One Cable End	6 dia.	Straight	1	XS5F-D421-C80-F	E2EW, E2E NEXT, E2EF, E2FM (M12 Pre-wired Smartclick Connector, M12 Connector)
					2	XS5F-D421-D80-F	
					3	XS5F-D421-E80-F	
					5	XS5F-D421-G80-F	
					10	XS5F-D421-J80-F	
					1	XS5F-D422-C80-F	
		2	XS5F-D422-D80-F				
		3	XS5F-D422-E80-F				
		5	XS5F-D422-G80-F				
		10	XS5F-D422-J80-F				
		Socket and Plug on Cable Ends	6 dia.	Straight (Socket)/ Straight (Plug)	1	XS5W-D421-C81-F	
					2	XS5W-D421-D81-F	
	Right-angle (Socket)/ Right-angle (Plug)			3	XS5W-D421-E81-F		
				5	XS5W-D421-G81-F		
	Straight (Socket)/ Right-angle (Plug)			10	XS5W-D421-J81-F		
				2	XS5W-D422-D81-F		
	Right-angle (Socket)/ Straight (Plug)	5	XS5W-D422-G81-F				
		2	XS5W-D423-D81-F				
Right-angle (Socket)/ Straight (Plug)	5	XS5W-D423-G81-F					
	2	XS5W-D424-D81-F					
Sockets on One Cable End	6.6 dia.	Straight	5	XS5W-D424-G81-F			
			2	XS5F-D421-D80-SA			
Socket and Plug on Cable Ends	6.6 dia.	Straight (Socket)/ Straight (Plug)	5	XS5F-D421-G80-SA			
			2	XS5W-D421-D81-SA			
					5	XS5W-D421-G81-SA	

Connections for Sensor I/O Connectors

DC 2-Wire

Proximity Sensor				Sensor I/O Connectors	
Type	Polarity	Operation mode	Model	Model	Connections *1
DC 2-Wire (Smartclick Connector)	Yes	NO	E2EW-(Q)X□D1□-M1TGJ E2EQ-X□D1□-M1TGJ E2EF-(Q)X□D1-M1TGJ E2FM-X□D1-M1TGJ	XS5F-D42□-□80-F XS5F-D421-□80-SA XS5W-D42□-□81-F XS5W-D421-□81-SA	
		NC	E2EQ-X□D2□-M1TGJ		
	No	NO	E2EW-(Q)X□D1□-M1TGJ-T E2EQ-X□D1□-M1TGJ-T		
		NC	E2EQ-X□D2□-M1TGJ-T		

DC 3-Wire

Proximity Sensor				Sensor I/O Connectors	
Types	Output	Operation mode	Model	Model	Connections *1
DC 3-Wire (M12 Connector / M12 Smartclick Connector)	PNP	NO	E2EW-(Q)X□B1□-M1TJ/M1 E2EQ-X□B1□-M1TJ/M1	XS5F-D42□-□80-F XS5F-D421-□80-SA XS5W-D42□-□81-F XS5W-D421-□81-SA	
		NC	E2EW-(Q)X□B2□-M1TJ/M1 E2EQ-X□B2□-M1TJ/M1		
		NO+NC	E2EW-(Q)X□B3□-M1TJ/M1 E2EQ-X□B3□-M1TJ/M1		
	NPN	NO	E2EW-(Q)X□C1□-M1TJ/M1 E2EQ-X□C1□-M1TJ/M1		
		NC	E2EW-(Q)X□C2□-M1TJ/M1 E2EQ-X□C2□-M1TJ/M1		
		NO+NC	E2EW-(Q)X□C3□-M1TJ/M1 E2EQ-X□C3□-M1TJ/M1		

*1. If the XS5W Series Connector which has a socket and plug on the cable ends is connected to the Sensor, this part will be a plug.
Note: Different from Proximity Sensor wire colors.

XS5

Dimensions

(Unit: mm)

Socket and Plug on Cable Ends XS5W

Wiring Diagram for 4 Cores



Straight (Socket)/straight (Plug)

XS5W-D421-□81-F/XS5W-D421-□81-SA

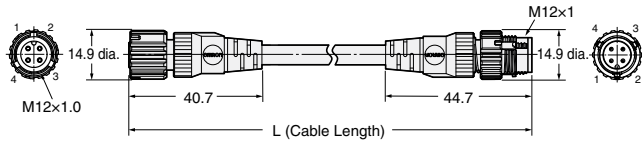

Sockets on One Cable End XS5F

Wiring Diagram for 4 Cores

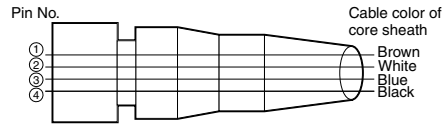

Straight type

XS5F-D421-□80-F/XS5F-D421-□80-SA

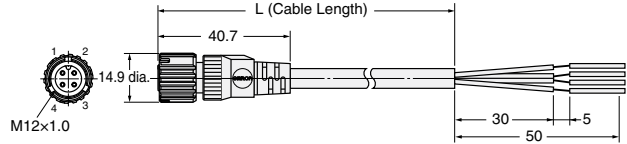

Right-angle (Socket)/right-angle (Plug)

XS5W-D422-□81-F



Right-angle type

XS5F-D422-□80-F



Straight (Socket)/right-angle (Plug)

XS5W-D423-□81-F



Right-angle (Socket)/straight (Plug)

XS5W-D424-□81-F

