

### Extensive Selection of Fiber-optic Sensing Heads Offers Many Unique Solutions for Tough Problems

- Fiber-optic sensors detect small, fast-moving objects in space-confined installations and harsh environments
- For a custom fit in the field, most plastic filament cables can be cut to length
- For detection in hard-to-reach places, sensing heads with bendable stainless steel tubing retain complex shapes
- Coiled and ultra-flexible cables are ideal for flexing and reciprocating machinery such as robots
- Side-view sensing heads or accessories save space in right-angle detection
- Convergent beam sensing heads allow accurate positioning and background suppression even for shiny objects
- Narrow detection zone of concentric beam sensing heads helps eliminate background objects and gives consistent sensing, regardless of object direction
- Highly flexible fibers with minimum 1-mm bending radius allows cable to conform to machine contours
- Most fiber cables offer IP67 protection and temperature ratings of  $-40^{\circ}\text{C}$  to  $70^{\circ}\text{C}$  ( $-40^{\circ}\text{F}$  to  $158^{\circ}\text{F}$ )

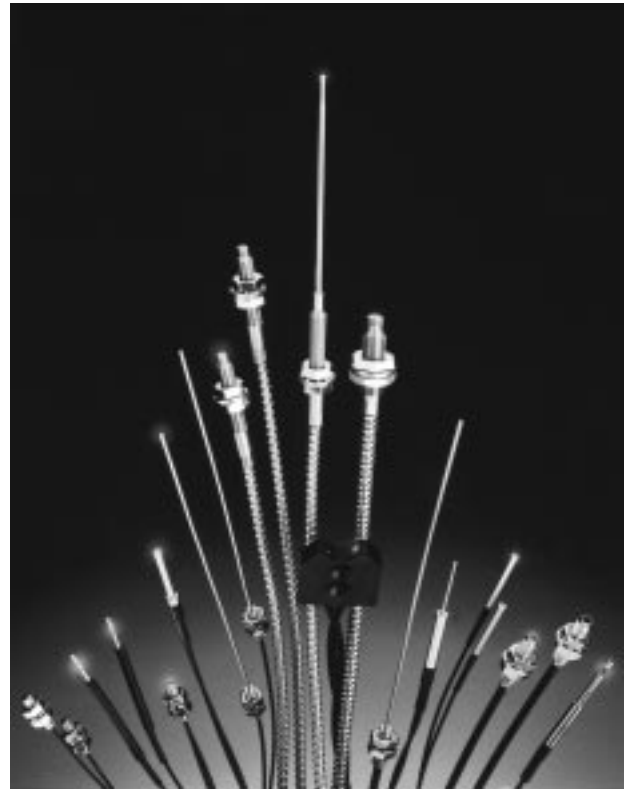

## ■ FIBER-OPTIC CABLE AND AMPLIFIER COMPATIBILITY

Fiber cables Part number	DIN-rail mounting amplifiers							Block style amplifiers			
	E3X-A	E3X-DA	E3X-F	E3X-H, -NH	E3X-NM	E3X-NT, -NV	E3X- NVG,-VG	E3MC- MY	E3XA- CC4A	E3JU-XR E3JU-X	E3A2-X E3S-X3
<b>Through-beam, General Purpose Type</b>											
E32-T11	OK	OK	OK	OK	OK	OK	OK	—	—	OK (-XR)	—
E32-T11L	OK	OK	OK	OK	OK	OK	OK	OK	—	—	—
E32-T11R	OK	OK	—	OK	OK	OK	—	—	—	—	—
E32-T12L	OK	OK	OK	OK	OK	OK	OK	—	—	—	—
E32-T17L	OK	OK	OK	OK	OK	OK	OK	OK	—	—	—
E32-T21	OK	OK	OK	OK	OK	OK	OK	—	—	OK (-XR)	—
E32-T21L	OK	OK	OK	OK	OK	OK	OK	—	—	—	—
E32-T21R	OK	OK	—	OK	OK	OK	—	—	—	—	—
E32-T22	OK	OK	OK	OK	OK	OK	OK	—	—	OK (-XR)	—
E32-T22L	OK	OK	OK	OK	OK	OK	OK	—	—	—	—
E32-TC50	OK	—	OK	OK (-H)	—	—	OK (-VG)	—	—	—	—
E32-TC200	OK	OK	OK	OK	OK	OK	OK	OK	OK	OK (-XR)	OK
E32-TC200A	OK	OK	OK	OK	OK	OK	OK	—	OK	—	OK
E32-TC200C	OK	—	OK	OK	OK	OK	OK	—	—	—	OK
E32-TC200E	OK	OK	OK	OK	OK	OK	OK	—	OK	—	OK
E32-TC500	OK	—	OK	OK (-H)	—	—	OK (-VG)	—	—	—	—
E32-TC1000	OK	—	OK	OK (-H)	—	—	OK (-VG)	—	—	—	—
<b>Through-beam, Armored Type</b>											
E32-UTAT13F	OK	—	—	—	—	—	—	—	—	OK (-XR)	—
E32-UTAT16F	OK	—	—	—	—	—	—	—	—	OK (-XR)	—
E32-UTBT13F	—	—	—	—	—	—	—	—	—	OK (-X)	—
E32-UTBT16F	—	—	—	—	—	—	—	—	—	OK (-X)	—
<b>Through-beam, Probe Type</b>											
E32-T33-1	OK	—	OK	OK (-H)	—	—	OK (-VG)	—	—	—	—
E32-TC200B	OK	OK	OK	OK	OK	OK	OK	—	OK	—	OK
E32-TC200B4	OK	OK	OK	OK	OK	OK	OK	—	OK	—	—
E32-TC200D	OK	—	OK	OK	—	—	OK (-VG)	—	—	—	OK
E32-TC200D4	OK	—	OK	OK	—	—	OK (-VG)	—	—	—	—
E32-TC200F	OK	OK	OK	OK	OK	OK	OK	—	OK	—	OK
E32-TC200F4	OK	OK	OK	OK	OK	OK	OK	—	OK	—	—
<b>Through-beam, Side Sensing Type</b>											
E32-T14	OK	OK	OK	OK	OK	OK	OK	—	OK	—	—
E32-T14L	OK	OK	OK	OK	OK	OK	OK	—	—	—	—
E32-T16	OK	OK	OK	OK	OK	OK	OK	OK	OK	—	—
E32-T16P	OK	OK	—	OK (-NH)	OK	OK	—	—	OK	—	—
E32-T24	OK	OK	OK	OK	OK	OK	OK	—	—	—	—
<b>Through-beam, High Temperature Type</b>											
E32-T51	OK	OK	OK	OK	OK	OK	OK	—	—	OK (-XR)	—
E32-T61	OK	OK	OK	OK	OK	OK	OK	—	—	—	—
<b>Through-beam, Special Purpose Type</b>											
E32-G14	OK	OK	OK	OK	OK	OK	OK	—	OK	—	—
E32-M21	OK	OK	OK	OK	OK	OK	OK	—	OK	—	—
E32-T12F	OK	OK	OK	OK	OK	OK	OK	—	—	—	—
E32-T22S	—	OK	—	OK	OK	OK	—	—	—	—	—
E32-T24S	—	OK	—	OK	OK	OK	—	—	—	—	—
E32-T84S	—	OK	—	OK (-NH)	OK	OK	—	—	—	—	—

Fiber cables	DIN-rail mounting amplifiers							Block style amplifiers			
Part number	E3X-A	E3X-DA	E3X-F	E3X-H, -NH	E3X-NM	E3X-NT, -NV	E3X- NVG,-VG	E3MC- MY	E3XA- CC4A	E3JU-XR E3JU-X	E3A2-X E3S-X3
<b>Diffuse, General Purpose Type</b>											
E32-CC200	OK	OK	OK	OK	OK	OK	OK	OK	OK	—	OK
E32-D11	OK	OK	OK	OK	OK	OK	OK	—	—	OK (-XR)	—
E32-D11L	OK	OK	OK	OK	OK	OK	OK	OK	—	—	—
E32-D11R	OK	OK	—	OK (-NH)	OK	OK	OK	—	—	—	—
E32-D21	OK	OK	OK	OK	OK	OK	OK	—	—	OK (-XR)	—
E32-D21L	OK	OK	OK	OK	OK	OK	OK	—	—	—	—
E32-D21R	OK	OK	—	OK (-NH)	OK	OK	—	—	—	—	—
E32-D22L	OK	OK	OK	OK	OK	OK	OK	—	—	—	—
E32-D32	OK	OK	OK	OK	OK	OK	OK	—	—	OK (-XR)	—
E32-D32L	OK	OK	OK	OK	OK	OK	OK	OK	—	—	—
E32-DC50	OK	—	OK	OK (-H)	—	—	OK (-VG)	—	—	—	—
E32-DC200	OK	OK	OK	OK	OK	OK	OK	OK	OK	OK (-XR)	OK
E32-DC200C	OK	—	OK	OK	OK	OK	OK	—	—	—	OK
E32-DC200E	OK	OK	OK	OK	OK	OK	OK	—	OK	—	OK
E32-DC500	OK	—	OK	OK (-H)	—	—	OK (-VG)	—	—	—	—
E32-DC1000	OK	—	OK	OK (-H)	—	—	OK (-VG)	—	—	—	—
<b>Diffuse, Armored Type</b>											
E32-UDAT13F	OK	—	—	—	—	—	—	—	—	OK (-XR)	—
E32-UDAT16F	OK	—	—	—	—	—	—	—	—	OK (-XR)	—
E32-UDBT13F	—	—	—	—	—	—	—	—	—	OK (-X)	—
E32-UDBT16F	—	—	—	—	—	—	—	—	—	OK (-X)	—
<b>Diffuse, Probe Type</b>											
E32-D33	OK	OK	OK	OK	OK	OK	—	—	OK	—	—
E32-DC200B	OK	OK	OK	OK	OK	OK	OK	—	OK	—	OK
E32-DC200B4	OK	OK	OK	OK	OK	OK	OK	—	—	—	OK
E32-DC200D	OK	—	OK	OK	—	—	OK (-VG)	—	—	—	OK
E32-DC200D4	OK	—	OK	OK	—	—	OK (-VG)	—	—	—	—
E32-DC200F	OK	OK	OK	OK	OK	OK	OK	—	OK	—	OK
E32-DC200F4	OK	OK	OK	OK	OK	OK	OK	—	OK	—	OK
E32-DC9G	OK	—	OK	OK	—	—	OK (-VG)	—	OK	—	—
E32-DC9G4	OK	—	OK	OK	—	—	OK (-VG)	—	—	—	—
<b>Diffuse, Side Sensing Type</b>											
E32-D14L	OK	OK	OK	OK	OK	OK	OK	—	—	—	—
E32-D24	OK	OK	OK	OK	OK	OK	OK	—	—	—	—
<b>Diffuse, High Temperature Type</b>											
E32-D51	OK	OK	OK	OK	OK	OK	OK	—	—	OK (-XR)	—
E32-D61	OK	OK	OK	OK	OK	OK	OK	—	—	—	—
E32-D73	OK	OK	OK	OK	OK	OK	OK	—	—	—	—
<b>Diffuse, Convergent and Special Purpose Types</b>											
E32-D12F	OK	OK	OK	OK	OK	OK	OK	—	—	—	—
E32-L24L	OK	OK	OK	OK	OK	OK	—	—	—	—	—
E32-L25	OK	OK	OK	OK	OK	OK	—	—	—	—	—
E32-L25A	OK	OK	OK	OK	OK	OK	—	—	—	—	—
E32-L25L	OK	OK	OK	OK	OK	OK	—	—	—	—	—
<b>Retroreflective Type</b>											
E32-R16	OK	OK	OK	OK	OK	OK	—	—	—	—	—
E32-R21	OK	OK	OK	OK	OK	OK	—	—	OK	—	—

## Ordering Information

Omron offers fiber-optic cables in through-beam, diffuse and retroreflective types. Each cable has a different sensing distance depending on the amplifier selected. The ordering information provides the sensing distance and compatibility with two general classes of amplifiers: DIN rail-mounting DC amplifiers and block style amplifiers with different attributes, such as AC/DC supply

voltage, analog output and color sensing.

 indicates models that customers can cut to length for their application. Models without this mark are pre-cut by the factory to maintain their respective specifications.

### ■ E3X-SERIES, DIN RAIL-MOUNTING AMPLIFIERS

The table specifies the sensing characteristics of each fiber when used with the following amplifiers:

#### Legend:

A . . . . . E3X-A (General purpose amplifier)

DA-HS . E3X-DA (Digital amplifier– high speed mode)

DA-LD . E3X-DA (Digital amplifier– long distance mode)

DA-SM . E3X-DA (Digital amplifier– standard distance mode)

F . . . . . E3X-F (High performance amplifier– high speed)

H . . . . . E3X-H11 (High gain amplifier)

NM . . . . E3X-NM (4 channel auto-tuning amplifier)

NT . . . . E3X-NT (Auto-tuning amplifier: general purpose)

NH . . . . E3X-NH (High-precision, auto-tuning amplifier)





NHB . . . E3X-NHB (High-precision, blue LED, auto-tuning amp)

NV . . . . E3X-NV21 (Water-resistant, red light source amplifier)

NVG . . . E3X-NVG21 (Water-resistant, green light source amp)

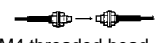
VG . . . . E3X-VG (Mark sensing amplifier)

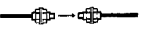
### ■ THROUGH-BEAM, GENERAL PURPOSE TYPE

Application	Features	Appearance	Type	Detection distance	Min. detectable object (opaque)	Part number
Flexible, resists breaking	Ideal for mounting on moving sections 4 mm bending radius	 M4 threaded head x 11.7 mm (0.46 in) L 2 m (6.56 ft) length	A	180 (1,000*) mm	0.2 mm dia.	E32-T11 
			DA-HS	250 (1,300*) mm	_____	
			DA-LD	850 (4,000**) mm	_____	
			DA-SM	680 (3,600*) mm	0.01 mm dia.	
			F	80 (400*) mm	0.2 mm dia.	
			H	360 (2,000*) mm	0.3 mm dia.	
			NH	360 (2,000*) mm	0.04 mm dia.	
			NHB	50 mm	0.04 mm dia.	
			NM	240 (1,300*) mm	0.2 mm dia.	
			NT	260 (1,400*) mm	0.1 mm dia.	
			NV	260 (1,400*) mm	0.1 mm dia.	
			NVG	10 (120*) mm	0.2 mm dia.	
			VG	10 (120*) mm	0.2 mm dia.	
Long distance	Compact M4, head, 1.4 mm ID fiber; 25 mm bending radius	 M4 threaded head x 11 mm (0.43 in) L 2 m (6.56 ft) length	A	350 (1,000*) mm	0.5 mm dia.	E32-T11L 
			DA-HS	490 (1,200*) mm	_____	
			DA-LD	1,660 (4,000**) mm	_____	
			DA-SM	1,330 (3,200*) mm	0.02 mm dia.	
			F	150 (550*) mm	0.5 mm dia.	
			H	700 (2,000*) mm	0.5 mm dia.	
			NH	700 (2,000*) mm	0.06 mm dia.	
			NHB	90 (250*) mm	0.06 mm dia.	
			NM	500 (1,200 *) mm	0.2 mm dia.	
			NT	540 (1,280*) mm	0.15 mm dia.	
			NV	540 (1,280*) mm	0.15 mm dia.	
			NVG	40 (120*) mm	0.5 mm dia.	
			VG	40 (120*) mm	0.5 mm dia.	

Note: \* Value in parentheses represents the sensing distance of the fiber when the E39-F1 lens is attached to its tip.

\*\* Value in parentheses is based on each fiber having a cable length of 2 m.

## ■ THROUGH-BEAM, GENERAL PURPOSE TYPE

The table specifies the sensing characteristics of each fiber when used with the following amplifiers:

### Legend:

A . . . . . E3X-A (General purpose amplifier)

DA-HS . E3X-DA (Digital amplifier– high speed mode)

DA-LD . E3X-DA (Digital amplifier– long distance mode)

DA-SM . E3X-DA (Digital amplifier– standard distance mode)

F . . . . . E3X-F (High performance amplifier– high speed)

H . . . . . E3X-H11 (High gain amplifier)

NM . . . . E3X-NM (4 channel auto-tuning amplifier)

NT . . . . E3X-NT (Auto-tuning amplifier: general purpose)





NH . . . . E3X-NH (High-precision, auto-tuning amplifier)

NHB . . . E3X-NHB (High-precision, blue LED, auto-tuning amp)

NV . . . . E3X-NV21 (Water-resistant, red light source amplifier)

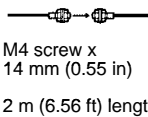
NVG . . . E3X-NVG21 (Water-resistant, green light source amp)

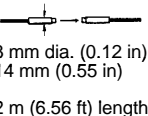
VG . . . . E3X-VG (Mark sensing amplifier)

Application	Features	Appearance	Type	Detection distance	Min. detectable object (opaque)	Part number
Flexible (resists breaking)	Can be bent like electric wires; 1 mm bending radius	 <p>M4 screw x 14 mm (0.55 in) 2 m (6.56 ft) length</p>	A	140 (1,000*)	0.2 mm dia.	<b>E32-T11R</b> 
			DA-HS	200 (1,400*) mm	_____	
			DA-LD	670 (4,000**) mm	_____	
			DA-SM	530 (3,700*) mm	0.01 mm dia.	
			F	Contact Omron	Contact Omron	
			H	280 (2,100*)	Contact Omron	
			NH	280 mm (2,100*)	0.1 mm dia.	
			NHB	Contact Omron	Contact Omron	
			NM	180 (1,300*) mm	0.2 mm dia.	
			NT	200 (1,400*) mm	0.1 mm dia.	
			NV	200 (1,400*) mm	0.1 mm dia.	
			NVG	Contact Omron	Contact Omron	
			VG	Contact Omron	Contact Omron	
Long distance	Compact unthreaded head; 1 mm ID fiber	 <p>3 mm dia. (0.12 in) x 14 mm (0.55 in) 2 m (6.56 ft) length</p>	A	350 mm	0.5 mm dia.	<b>E32-T12L</b> 
			DA-HS	490 mm	_____	
			DA-LD	1,660 mm	_____	
			DA-SM	1,330 mm	0.01 mm dia.	
			F	150 mm	0.5 mm dia.	
			H	700 mm	0.5 mm dia.	
			NH	700 mm	0.06 mm dia.	
			NHB	90 mm	0.06 mm dia.	
			NM	500 mm	0.2 mm dia.	
			NT	540 mm	0.15 mm dia.	
			NV	540 mm	0.15 mm dia.	
			NVG	40 mm	0.5 mm dia.	
			VG	40 mm	0.5 mm dia.	

Note: \* Value in parentheses represents the sensing distance of the fiber when the E39-F1 lens is attached to its tip.

\*\* Value in parentheses is based on each fiber having a cable length of 2 m.

## ■ THROUGH-BEAM, GENERAL PURPOSE TYPE

The table specifies the sensing characteristics of each fiber when used with the following amplifiers:

### Legend:

A . . . . . E3X-A (General purpose amplifier)

DA-HS . E3X-DA (Digital amplifier— high speed mode)

DA-LD . E3X-DA (Digital amplifier— long distance mode)

DA-SM . E3X-DA (Digital amplifier— standard distance mode)

F . . . . . E3X-F (High performance amplifier— high speed)

H . . . . . E3X-H11 (High gain amplifier)

NM . . . . E3X-NM (4 channel auto-tuning amplifier)

NT . . . . E3X-NT (Auto-tuning amplifier: general purpose)





NH . . . . E3X-NH (High-precision, auto-tuning amplifier)

NHB . . . E3X-NHB (High-precision, blue LED, auto-tuning amp)

NV . . . . E3X-NV21 (Water-resistant, red light source amplifier)

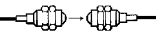
NVG . . . E3X-NVG21 (Water-resistant, green light source amp)

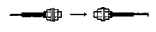
VG . . . . E3X-VG (Mark sensing amplifier)

Application	Features	Appearance	Type	Detection distance	Min. detectable object (opaque)	Part number
Long distance	Magnifying lens extends sensing distance; ideal for explosion-proof applications; 25 mm bending radius; M14 head, 1 mm ID fiber	 M14 threaded head x 23 mm (0.91 in) L 10 m (32.8 ft) length	A	7,000 mm	0.8 mm dia.	<b>E32-T17L</b> 
			DA-HS	9,800 mm	_____	
			DA-LD	20,000 mm *	_____	
			DA-SM	20,000 mm *	0.01 mm dia.	
			F	3,000 mm	1.5 mm dia.	
			H	14,000 mm	2.1 mm dia.	
			NH	14,000 mm	0.2 mm dia.	
			NHB	2,000 mm	0.2 mm dia.	
			NM	7,000 mm	0.7 mm dia.	
			NT	7,500 mm	0.5 mm dia.	
			NV	7,500 mm	0.5 mm dia.	
			NVG	800 mm	2.1 mm dia.	
			VG	800 mm	2.1 mm dia.	
Flexible (resists breaking)	Ideal for mounting on moving sections; 4 mm bending radius; 0.5 mm ID fiber	 M3 threaded head x 11 mm (0.43 in) L 2 m (6.56 ft) length	A	50 mm	0.2 mm dia.	<b>E32-T21</b> 
			DA-HS	80 mm	_____	
			DA-LD	220 mm	_____	
			DA-SM	200 mm	0.01 mm dia.	
			F	26 mm	0.2 mm dia.	
			H	100 mm	0.2 mm dia.	
			NH	100 mm	0.04 mm dia.	
			NHB	Contact Omron	Contact Omron	
			NM	65 mm	0.2 mm dia.	
			NT	70 mm	0.1 mm dia.	
			NV	70 mm	0.1 mm dia.	
			NVG	6 mm	0.1 mm dia.	
			VG	6 mm	0.2 mm dia.	

Note: \* Value is based on each fiber having a cable length of 10 m.

## ■ THROUGH-BEAM, GENERAL PURPOSE TYPE

The table specifies the sensing characteristics of each fiber when used with the following amplifiers:

### Legend:

A . . . . . E3X-A (General purpose amplifier)

DA-HS . E3X-DA (Digital amplifier– high speed mode)

DA-LD . E3X-DA (Digital amplifier– long distance mode)

DA-SM . E3X-DA (Digital amplifier– standard distance mode)

F . . . . . E3X-F (High performance amplifier– high speed)

H . . . . . E3X-H11 (High gain amplifier)

NM . . . . E3X-NM (4 channel auto-tuning amplifier)

NT . . . . E3X-NT (Auto-tuning amplifier: general purpose)





NH . . . . E3X-NH (High-precision, auto-tuning amplifier)

NHB . . . E3X-NHB (High-precision, blue LED, auto-tuning amp)

NV . . . . E3X-NV21 (Water-resistant, red light source amplifier)

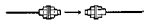
NVG . . . E3X-NVG21 (Water-resistant, green light source amp)

VG . . . . E3X-VG (Mark sensing amplifier)

Application	Features	Appearance	Type	Detection distance	Min. detectable object (opaque)	Part number
Long distance	Compact mounting head; 25 mm bending radius; 0.5 mm ID fiber	 M3 threaded head x 9 mm (0.35 in) L 2 m (6.56 ft) length	A	100 mm	0.2 mm dia.	<b>E32-T21L</b> 
			DA-HS	180 mm	_____	
			DA-LD	500 mm	_____	
			DA-SM	440 mm	0.01 mm dia.	
			F	50 mm	0.2 mm dia.	
			H	200 mm	0.2 mm dia.	
			NH	200 mm	0.04 mm dia.	
			NHB	Contact Omron	Contact Omron	
			NM	150 mm	0.2 mm dia.	
			NT	160 mm	0.1 mm dia.	
			NV	160 mm	0.1 mm dia.	
			NVG	10 mm	0.2 mm dia.	
			VG	10 mm	0.2 mm dia.	
Flexible (resists breaking)	Can be bent like electric wires; 1 mm bending radius	 M3 threaded head x 9.5 mm (0.37 in) L 2 m (6.56 ft) length	A	30 mm	0.2 mm dia.	<b>E32-T21R</b> 
			DA-HS	50 mm	_____	
			DA-LD	150 mm	_____	
			DA-SM	130 mm	0.01 mm dia.	
			F	Contact Omron	Contact Omron	
			H	60 mm	0.2 mm dia.	
			NH	60 mm	0.1 mm dia.	
			NHB	Contact Omron	Contact Omron	
			NM	40 mm	0.2 mm dia.	
			NT	41 mm	0.1 mm dia.	
			NV	41 mm	0.1 mm dia.	
			NVG	Contact Omron	Contact Omron	
			VG	Contact Omron	Contact Omron	

## ■ THROUGH-BEAM, GENERAL PURPOSE TYPE

The table specifies the sensing characteristics of each fiber when used with the following amplifiers:

### Legend:

A . . . . . E3X-A (General purpose amplifier)

DA-HS . E3X-DA (Digital amplifier– high speed mode)

DA-LD . E3X-DA (Digital amplifier– long distance mode)

DA-SM . E3X-DA (Digital amplifier– standard distance mode)

F . . . . . E3X-F (High performance amplifier– high speed)

H . . . . . E3X-H11 (High gain amplifier)

NM . . . . E3X-NM (4 channel auto-tuning amplifier)

NT . . . . E3X-NT (Auto-tuning amplifier: general purpose)





NH . . . . E3X-NH (High-precision, auto-tuning amplifier)

NHB . . . E3X-NHB (High-precision, blue LED, auto-tuning amp)

NV . . . . E3X-NV21 (Water-resistant, red light source amplifier)

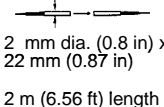
NVG . . . E3X-NVG21 (Water-resistant, green light source amp)

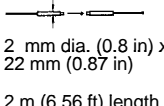
VG . . . . E3X-VG (Mark sensing amplifier)

Application	Features	Appearance	Type	Detection distance	Min. detectable object (opaque)	Part number
Minute objects	2 mm dia. head fits in space-confined areas; 25 mm bending radius; 0.5 mm ID fiber	 2 mm dia. (0.8 in) x 22 mm (0.87 in) 2 m (6.56 ft) length	A	50 mm	0.1 mm dia.	<b>E32-T22</b> 
			DA-HS	90 mm	_____	
			DA-LD	250 mm	_____	
			DA-SM	220 mm	0.01 mm dia.	
			F	26 mm	0.1 mm dia.	
			H	100 mm	0.1 mm dia.	
			NH	100 mm	0.04 mm dia.	
			NHB	Contact Omron	Contact Omron	
			NM	70 mm	0.2 mm dia.	
			NT	75 mm	0.1 mm dia.	
			NV	75 mm	0.1 mm dia.	
			NVG	7 mm	0.1 mm dia.	
			VG	7 mm	0.1 mm dia.	
Long distance	2 mm dia. head fits in space-confined areas; 25 mm bending radius; 0.5 mm ID fiber	 2 mm dia. (0.8 in) x 22 mm (0.87 in) 2 m (6.56 ft) length	A	100 mm	0.2 mm dia.	<b>E32-T22L</b> 
			DA-HS	180 mm	_____	
			DA-LD	500 mm	_____	
			DA-SM	440 mm	0.01 mm dia.	
			F	50 mm	0.2 mm dia.	
			H	200 mm	0.2 mm dia.	
			NH	200 mm	0.04 mm dia.	
			NHB	Contact Omron	Contact Omron	
			NM	150 mm	0.2 mm dia.	
			NT	160 mm	0.1 mm dia.	
			NV	160 mm	0.1 mm dia.	
			NVG	10 mm	0.2 mm dia.	
			VG	10 mm	0.2 mm dia.	



## ■ THROUGH-BEAM, GENERAL PURPOSE TYPE

The table specifies the sensing characteristics of each fiber when used with the following amplifiers:

### Legend:

A . . . . . E3X-A (General purpose amplifier)

DA-HS . E3X-DA (Digital amplifier– high speed mode)

DA-LD . E3X-DA (Digital amplifier– long distance mode)

DA-SM . E3X-DA (Digital amplifier– standard distance mode)

F . . . . . E3X-F (High performance amplifier– high speed)

H . . . . . E3X-H11 (High gain amplifier)

NM . . . . E3X-NM (4 channel auto-tuning amplifier)

NT . . . . E3X-NT (Auto-tuning amplifier: general purpose)





NH . . . . E3X-NH (High-precision, auto-tuning amplifier)

NHB . . . E3X-NHB (High-precision, blue LED, auto-tuning amp)

NV . . . . E3X-NV21 (Water-resistant, red light source amplifier)

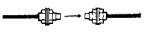
NVG . . . E3X-NVG21 (Water-resistant, green light source amp)

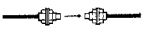
VG . . . . E3X-VG (Mark sensing amplifier)

Application	Features	Appearance	Type	Detection distance	Min. detectable object (opaque)	Part number
General purpose	Compact threaded head; short cable length; 25 mm bending radius; 1 mm ID fiber	 M4 threaded head x 14 mm (0.55 in) L 50 cm (1.64 ft) length	A	200 (1,500*) mm	0.2 mm dia.	<b>E32-TC50</b> 
			DA-HS	Contact Omron	Contact Omron	
			DA-LD	Contact Omron	Contact Omron	
			DA-SM	Contact Omron	Contact Omron	
			F	80 mm	0.2 mm dia.	
			H	400 (3,000*) mm	0.2 mm dia.	
			NH	Contact Omron	Contact Omron	
			NHB	Contact Omron	Contact Omron	
			NM	Contact Omron	Contact Omron	
			NT	Contact Omron	Contact Omron	
			NV	Contact Omron	Contact Omron	
			NVG	Contact Omron	Contact Omron	
			VG	28 mm (190*) mm	0.2 mm dia.	
General purpose	Compact threaded head; 25 mm bending radius; 1 mm ID fiber	 M4 threaded head x 14 mm (0.55 in) L 2 m (6.56 ft) length	A	200 (1,500*) mm	0.2 mm dia.	<b>E32-TC200</b> 
			DA-HS	280 (2,100*) mm	—————	
			DA-LD	950 (4,000**) mm	—————	
			DA-SM	760 (4,000**) mm	0.01 mm dia.	
			F	80 (670*) mm	0.2 mm dia.	
			H	400 (3,000*) mm	0.2 mm dia.	
			NH	400 (3,000*) mm	0.04 mm dia.	
			NHB	55 (420*) mm	0.04 mm dia.	
			NM	270 (2,000*) mm	0.2 mm dia.	
			NT	290 (2,100*) mm	0.1 mm dia.	
			NV	290 (2,100*) mm	0.1 mm dia.	
			NVG	28 mm (190*) mm	0.2 mm dia.	
			VG	28 mm (190*) mm	0.2 mm dia.	

Note: \* Value in parentheses represents the sensing distance of the fiber when the E39-F1 lens is attached to its tip.

\*\* Value in parentheses is based on each fiber having a cable length of 2 m.

## ■ THROUGH-BEAM, GENERAL PURPOSE TYPE

The table specifies the sensing characteristics of each fiber when used with the following amplifiers:

### Legend:

A . . . . . E3X-A (General purpose amplifier)

DA-HS . E3X-DA (Digital amplifier– high speed mode)

DA-LD . E3X-DA (Digital amplifier– long distance mode)

DA-SM . E3X-DA (Digital amplifier– standard distance mode)

F . . . . . E3X-F (High performance amplifier– high speed)

H . . . . . E3X-H11 (High gain amplifier)

NM . . . . E3X-NM (4 channel auto-tuning amplifier)

NT . . . . E3X-NT (Auto-tuning amplifier: general purpose)





NH . . . . E3X-NH (High-precision, auto-tuning amplifier)

NHB . . . E3X-NHB (High-precision, blue LED, auto-tuning amp)

NV . . . . E3X-NV21 (Water-resistant, red light source amplifier)

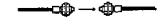
NVG . . . E3X-NVG21 (Water-resistant, green light source amp)

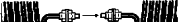
VG . . . . E3X-VG (Mark sensing amplifier)

Application	Features	Appearance	Type	Detection distance	Min. detectable object (opaque)	Part number
General purpose	M3; possible to mount the reflective side-view conversion attachment (E39-F5); 25 mm bending radius; 1 mm ID fiber	 M3 threaded head x 7 mm (0.28 in) L 2 m (6.56 ft) length	A	180 mm	0.2 mm dia.	<b>E32-TC200A</b> 
			DA-HS	250 mm	_____	
			DA-LD	850 mm	_____	
			DA-SM	680 mm	0.01 mm dia.	
			F	80 mm	0.2 mm dia.	
			H	360 mm	0.3 mm dia.	
			NH	360 mm	0.04 mm dia.	
			NHB	55 mm	0.04 mm dia.	
			NM	250 mm	0.2 mm dia.	
			NT	270 mm	0.1 mm dia.	
			NV	270 mm	0.1 mm dia.	
			NVG	28 mm	0.2 mm dia.	
			VG	28 mm	0.2 mm dia.	
General purpose	Spiral coiled cable withstands repeated stretching from reciprocating machine parts; 25 mm bending radius; 1 mm ID fiber	 M4 threaded head x 11 mm (0.43 in) L Coiled 56.5 cm (1.8 ft) L; 2 m (6.56 ft) extended	A	150 (800*) mm	0.2 mm dia.	<b>E32-TC200C</b> 
			DA-HS	Contact Omron	Contact Omron	
			DA-LD	Contact Omron	Contact Omron	
			DA-SM	Contact Omron	Contact Omron	
			F	60 (350*) mm	0.2 mm dia.	
			H	300 (1,600*) mm	0.2 mm dia.	
			NH	300 (3,600*) mm	0.04 mm dia.	
			NHB	Contact Omron	Contact Omron	
			NM	200 (800*) mm	0.2 mm dia.	
			NT	210 (850*) mm	0.1 mm dia.	
			NV	210 (850*) mm	0.1 mm dia.	
			NVG	18 (100*) mm	0.2 mm dia.	
			VG	18 (100*) mm	0.2 mm dia.	

Note: \*Value in parentheses represents the sensing distance of the fiber when the E39-F1 lens is attached to its tip.

## ■ THROUGH-BEAM, GENERAL PURPOSE TYPE

### Legend:

A . . . . . E3X-A (General purpose amplifier)

DA-HS . E3X-DA (Digital amplifier– high speed mode)

DA-LD . E3X-DA (Digital amplifier– long distance mode)

DA-SM . E3X-DA (Digital amplifier– standard distance mode)

F . . . . . E3X-F (High performance amplifier– high speed)

H . . . . . E3X-H11 (High gain amplifier)

NM . . . . E3X-NM (4 channel auto-tuning amplifier)

NT . . . . E3X-NT (Auto-tuning amplifier: general purpose)



NH . . . . E3X-NH (High-precision, auto-tuning amplifier)

NHB . . . E3X-NHB (High-precision, blue LED, auto-tuning amp)

NV . . . . E3X-NV21 (Water-resistant, red light source amplifier)

NVG . . . E3X-NVG21 (Water-resistant, green light source amp)

VG . . . . E3X-VG (Mark sensing amplifier)

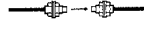
Application	Features	Appearance	Type	Detection distance	Min. detectable object (opaque)	Part number
General purpose	M3; suitable for detecting minute objects; 25 mm bending radius; 0.5 mm ID fiber	 M3 threaded head x 11 mm (0.43 in) L  2 m (6.56 ft) length	A	50 mm	0.1 mm dia.	<b>E32-TC200E</b> ✂
			DA-HS	90 mm	_____	
			DA-LD	250 mm	_____	
			DA-SM	220 mm	0.01 mm dia.	
			F	26 mm	0.1 mm dia.	
			H	100 mm	0.1 mm dia.	
			NH	100 mm	0.04 mm dia.	
			NHB	Contact Omron	Contact Omron	
			NM	70 mm	0.2 mm dia.	
			NT	75 mm	0.1 mm dia.	
			NV	75 mm	0.1 mm dia.	
			NVG	8 mm	0.1 mm dia.	
			VG	8 mm	0.1 mm dia.	
General purpose	Extended length and sensing distance; 25 mm bending radius; 1 mm ID fiber	 M4 threaded head x 14 mm (0.55 in) L  5 m (16.4 ft) length	A	200 (1,500*) mm	0.2 mm dia.	<b>E32-TC500</b> ✂
			DA-HS	Contact Omron	Contact Omron	
			DA-LD	Contact Omron	Contact Omron	
			DA-SM	Contact Omron	Contact Omron	
			F	80 mm	0.2 mm dia.	
			H	400 (3,000*) mm	0.2 mm dia.	
			NH	Contact Omron	Contact Omron	
			NHB	Contact Omron	Contact Omron	
			NM	Contact Omron	Contact Omron	
			NT	Contact Omron	Contact Omron	
			NV	Contact Omron	Contact Omron	
			NVG	Contact Omron	Contact Omron	
			VG	28 mm	0.2 mm dia.	
General purpose	Extended length and sensing distance; 25 mm bending radius; 1 mm ID fiber	 M4 threaded head x 14 mm (0.55 in) L  10 m (32.8 ft) length	A	500 (1000*) mm	0.01 mm dia.	<b>E32-TC1000</b> ✂
			DA-HS	Contact Omron	Contact Omron	
			DA-LD	Contact Omron	Contact Omron	
			DA-SM	Contact Omron	Contact Omron	
			F	500(1,000*) mm	0.01 mm dia.	
			H	500 (1,000*) mm	0.01 mm dia.	
			NH	Contact Omron	Contact Omron	
			NHB	Contact Omron	Contact Omron	
			NM	Contact Omron	Contact Omron	
			NT	Contact Omron	Contact Omron	
			NV	Contact Omron	Contact Omron	
			NVG	Contact Omron	Contact Omron	
			VG	500 (1,000*) mm	0.01 mm dia.	

Note: \*Value in parentheses represents the sensing distance of the fiber when the E39-F1 lens is attached to its tip.

## ■ THROUGH-BEAM, ARMORED TYPE

The table specifies the sensing characteristics of each fiber when used with the following amplifiers:

### Legend:

A . . . . . E3X-A (General purpose amplifier)

DA-HS . E3X-DA (Digital amplifier– high speed mode)

DA-LD . E3X-DA (Digital amplifier– long distance mode)

DA-SM . E3X-DA (Digital amplifier– standard distance mode)

F . . . . . E3X-F (High performance amplifier– high speed)

H . . . . . E3X-H11 (High gain amplifier)

NM . . . . E3X-NM (4 channel auto-tuning amplifier)

NT . . . . E3X-NT (Auto-tuning amplifier: general purpose)

NH . . . . E3X-NH (High-precision, auto-tuning amplifier)

NHB . . . E3X-NHB (High-precision, blue LED, auto-tuning amp)

NV . . . . E3X-NV21 (Water-resistant, red light source amplifier)

NVG . . . E3X-NVG21 (Water-resistant, green light source amp)

VG . . . . E3X-VG (Mark sensing amplifier)

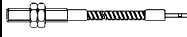
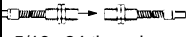
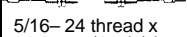
Application	Features	Appearance	Type	Detection distance	Min. detectable object (opaque)	Part number
General purpose	Can withstand temperatures to 150°C (302°F)	 5/16 – 24 thread x 3.8 mm (1.5 in) L 0.91 m (3 ft) length	A	200 mm	0.2 mm dia.	<b>E32-UTAT1-3F</b>
			DA-HS	Contact Omron	Contact Omron	
			DA-LD	Contact Omron	Contact Omron	
			DA-SM	Contact Omron	Contact Omron	
			F	Contact Omron	Contact Omron	
			H	Contact Omron	Contact Omron	
			NH	Contact Omron	Contact Omron	
			NHB	Contact Omron	Contact Omron	
			NM	Contact Omron	Contact Omron	
			NT	Contact Omron	Contact Omron	
			NV	Contact Omron	Contact Omron	
			NVG	Contact Omron	Contact Omron	
			VG	Contact Omron	Contact Omron	
General purpose	Can withstand temperatures to 150°C (302°F)	 5/16 – 24 thread x 3.8 mm (1.5 in) L 1.83 m (6 ft) length	A	170 mm	0.2 mm dia.	<b>E32-UTAT1-6F</b>
			DA-HS	Contact Omron	Contact Omron	
			DA-LD	Contact Omron	Contact Omron	
			DA-SM	Contact Omron	Contact Omron	
			F	Contact Omron	Contact Omron	
			H	Contact Omron	Contact Omron	
			NH	Contact Omron	Contact Omron	
			NHB	Contact Omron	Contact Omron	
			NM	Contact Omron	Contact Omron	
			NT	Contact Omron	Contact Omron	
			NV	Contact Omron	Contact Omron	
			NVG	Contact Omron	Contact Omron	
			VG	Contact Omron	Contact Omron	
General purpose	Can withstand temperatures to 200°C (392°F)	 5/16– 24 thread x 38.1 mm (1.5 in) L 0.91 m (3 ft) length	E3JU-X amp only	400 mm	0.25 mm dia.	<b>E32-UTBT1-3F</b>
General purpose	Can withstand temperatures to 200°C (392°F)	 5/16– 24 thread x 38.1 mm (1.5 in) L 1.83 m (6 ft) length	E3JU-X amp only	400 mm	0.25 mm dia.	<b>E32-UTBT1-6F</b>

## ■ THROUGH-BEAM, PROBE TYPE

The table specifies the sensing characteristics of each fiber when used with the following amplifiers:

### Legend:

A . . . . . E3X-A (General purpose amplifier)

DA-HS . E3X-DA (Digital amplifier– high speed mode)

DA-LD . E3X-DA (Digital amplifier– long distance mode)

DA-SM . E3X-DA (Digital amplifier– standard distance mode)

F . . . . . E3X-F (High performance amplifier– high speed)

H . . . . . E3X-H11 (High gain amplifier)

NM . . . . E3X-NM (4 channel auto-tuning amplifier)

NT . . . . E3X-NT (Auto-tuning amplifier: general purpose)





NH . . . . E3X-NH (High-precision, auto-tuning amplifier)

NHB . . . E3X-NHB (High-precision, blue LED, auto-tuning amp)

NV . . . . E3X-NV21 (Water-resistant, red light source amplifier)

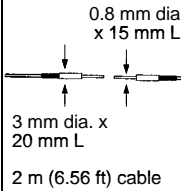
NVG . . . E3X-NVG21 (Water-resistant, green light source amp)

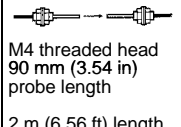
VG . . . . E3X-VG (Mark sensing amplifier)

Application	Features	Appearance	Type	Detection distance	Min. detectable object (opaque)	Part number
Needle probe	303 stainless steel probe for ultra small objects; 12 mm heat shrink tubing can provide extra sealing and strain relief; 25 mm bending radius; 0.25 mm ID fiber	 <p>0.8 mm dia. x 15 mm L</p> <p>3 mm dia. x 20 mm L</p> <p>2 m (6.56 ft) cable</p>	A	15 mm	0.06 mm dia.	<b>E32-T33-1</b> 
			DA-HS	Contact Omron	Contact Omron	
			DA-LD	Contact Omron	Contact Omron	
			DA-SM	Contact Omron	Contact Omron	
			F	15 mm	0.06 mm dia.	
			H	15 mm	0.06 mm dia.	
			NH	Contact Omron	Contact Omron	
			NHB	Contact Omron	Contact Omron	
			NM	Contact Omron	Contact Omron	
			NT	Contact Omron	Contact Omron	
			NV	Contact Omron	Contact Omron	
			NVG	Contact Omron	Contact Omron	
			VG	15 mm	0.06 mm dia.	
Thin fiber	Probe for space-confined sensing areas; 25 mm bending radius; 1 mm ID fiber.	 <p>M4 threaded head 90 mm (3.54 in) probe length</p> <p>2 m (6.56 ft) length</p>	A	180 mm	0.2 mm dia.	<b>E32-TC200B</b> 
			DA-HS	280 mm	—————	
			DA-LD	950 mm	—————	
			DA-SM	760 mm	0.01 mm dia.	
			F	80 mm	0.2 mm dia.	
			H	400 mm	0.2 mm dia.	
			NH	400 mm	0.04 mm dia.	
			NHB	55mm	0.04 mm dia.	
			NM	270 mm	0.2 mm dia.	
			NT	290 mm	0.1 mm dia.	
			NV	290 mm	0.1 mm dia.	
			NVG	28 mm	0.2 mm dia.	
			VG	28 mm	0.2 mm dia.	

## ■ THROUGH-BEAM, PROBE TYPE (CONT.)

### Legend:

A . . . . . E3X-A (General purpose amplifier)

DA-HS . E3X-DA (Digital amplifier– high speed mode)

DA-LD . E3X-DA (Digital amplifier– long distance mode)

DA-SM . E3X-DA (Digital amplifier– standard distance mode)

F . . . . . E3X-F (High performance amplifier– high speed)

H . . . . . E3X-H11 (High gain amplifier)

NM . . . . E3X-NM (4 channel auto-tuning amplifier)

NT . . . . E3X-NT (Auto-tuning amplifier: general purpose)

NH . . . . E3X-NH (High-precision, auto-tuning amplifier)

NHB . . . . E3X-NHB (High-precision, blue LED, auto-tuning amp)

NV . . . . E3X-NV21 (Water-resistant, red light source amplifier)

NVG . . . . E3X-NVG21 (Water-resistant, green light source amp)

VG . . . . E3X-VG (Mark sensing amplifier)

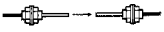
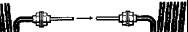
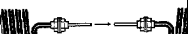
Application	Features	Appearance	Type	Detection distance	Min. detectable object (opaque)	Part number
Thin fiber	Probe for space-confined sensing areas; 25 mm bending radius; 1 mm ID fiber	 <p>M4 threaded head 40 mm (1.57 in) probe length</p> <p>2 m (6.56 ft) length</p>	A	180 mm	0.2 mm dia.	<b>E32-TC200B4</b> ✂
			DA-HS	280 mm	_____	
			DA-LD	950 mm	_____	
			DA-SM	760 mm	0.01 mm dia.	
			F	80 mm	0.2 mm dia.	
			H	400 mm	0.2 mm dia.	
			NH	400 mm	0.04 mm dia.	
			NHB	55 mm	0.04 mm dia.	
			NM	270 mm	0.2 mm dia.	
			NT	290 mm	0.1 mm dia.	
			NV	290 mm	0.1 mm dia.	
			NVG	28 mm	0.2 mm dia.	
			VG	28 mm	0.2 mm dia.	
Thin probe	Sensing head with 90 mm probe; spiral coiled cable with-stands repeated stretching from reciprocating machine parts; 25 mm bending radius; 1 mm ID fiber	 <p>M4 threaded head 90 mm (3.54 in) probe length</p> <p>Coiled 56.6 cm (1.85 ft); 2 m (6.56 ft) when extended</p>	A	150 mm	0.2 mm dia.	<b>E32-TC200D</b> ✂
			DA-HS	Contact Omron	Contact Omron	
			DA-LD	Contact Omron	Contact Omron	
			DA-SM	Contact Omron	Contact Omron	
			F	60 mm	0.2 mm dia.	
			H	300 mm	0.2 mm dia.	
			NH	300 mm	0.04 mm dia.	
			NHB	Contact Omron	Contact Omron	
			NM	Contact Omron	Contact Omron	
			NT	Contact Omron	Contact Omron	
			NV	Contact Omron	Contact Omron	
			NVG	Contact Omron	Contact Omron	
			VG	18 mm	0.2 mm dia.	
Thin probe	Sensing head with 40 mm probe; spiral coiled cable withstands repeated stretching from reciprocating machine parts; 25 mm bending radius; 1 mm ID fiber	 <p>M4 threaded head 40 mm (1.57 in) probe length</p> <p>Coiled 56.6 cm (1.85 ft); 2 m (6.56 ft) when extended</p>	A	150 mm	0.2 mm dia.	<b>E32-TC200D4</b> ✂
			DA-HS	Contact Omron	Contact Omron	
			DA-LD	Contact Omron	Contact Omron	
			DA-SM	Contact Omron	Contact Omron	
			F	60 mm	0.2 mm dia.	
			H	300 mm	0.2 mm dia.	
			NH	300 mm	0.04 mm dia.	
			NHB	Contact Omron	Contact Omron	
			NM	Contact Omron	Contact Omron	
			NT	Contact Omron	Contact Omron	
			NV	Contact Omron	Contact Omron	
			NVG	Contact Omron	Contact Omron	
			VG	18 mm	0.2 mm dia.	

## ■ THROUGH BEAM, PROBE TYPE (CONT.)

### Legend:

A . . . . . E3X-A (General purpose amplifier)

DA-HS . E3X-DA (Digital amplifier– high speed mode)

DA-LD . E3X-DA (Digital amplifier– long distance mode)

DA-SM . E3X-DA (Digital amplifier– standard distance mode)

F . . . . . E3X-F (High performance amplifier– high speed)

H . . . . . E3X-H11 (High gain amplifier)

NM . . . . E3X-NM (4 channel auto-tuning amplifier)

NT . . . . E3X-NT (Auto-tuning amplifier: general purpose)





NH . . . . E3X-NH (High-precision, auto-tuning amplifier)

NHB . . . E3X-NHB (High-precision, blue LED, auto-tuning amp)

NV . . . . E3X-NV21 (Water-resistant, red light source amplifier)

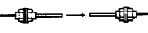
NVG . . . E3X-NVG21 (Water-resistant, green light source amp)

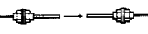
VG . . . . E3X-VG (Mark sensing amplifier)

Application	Features	Appearance	Type	Detection distance	Min. detectable object (opaque)	Part number
Thin probe	Sensing head with 90 mm probe; 25 mm bending radius; 0.5 mm ID fiber	 <p>M3 threaded head 90 mm (3.54 in) length probe</p> <p>2 m (6.56 ft) length</p>	A	50 mm	0.1 mm dia.	<b>E32-TC200F</b> 
			DA-HS	90 mm	_____	
			DA-LD	250 mm	_____	
			DA-SM	220 mm	0.01 mm dia.	
			F	26 mm	0.1 mm dia.	
			H	100 mm	0.1 mm dia.	
			NH	100 mm	0.04 mm dia.	
			NHB	Contact Omron	Contact Omron	
			NM	70 mm	0.2 mm dia.	
			NT	75 mm	0.1 mm dia.	
			NV	75 mm	0.1 mm dia.	
			NVG	8 mm	0.1 mm dia.	
			VG	8 mm	0.1 mm dia.	
Thin probe	Sensing head with 40 mm probe; 25 mm bending radius; 0.5 mm ID fiber	 <p>M3 threaded head 40 mm (1.57 in) length probe</p> <p>2m (6.56 ft) length</p>	A	50 mm	0.1 mm dia.	<b>E32-TC200F4</b> 
			DA-HS	90 mm	_____	
			DA-LD	250 mm	_____	
			DA-SM	220 mm	0.01 mm dia.	
			F	26 mm	0.1 mm dia.	
			H	100 mm	0.1 mm dia.	
			NH	100 mm	0.04 mm dia.	
			NHB	Contact Omron	Contact Omron	
			NM	70 mm	0.2 mm dia.	
			NT	75 mm	0.1 mm dia.	
			NV	75 mm	0.1 mm dia.	
			NVG	8 mm	0.1 mm dia.	
			VG	8 mm	0.1 mm dia.	

## ■ THROUGH-BEAM, SIDE BEAM TYPE

The table specifies the sensing characteristics of each fiber when used with the following amplifiers:

### Legend:

A . . . . . E3X-A (General purpose amplifier)

DA-HS . E3X-DA (Digital amplifier– high speed mode)

DA-LD . E3X-DA (Digital amplifier– long distance mode)

DA-SM . E3X-DA (Digital amplifier– standard distance mode)

F . . . . . E3X-F (High performance amplifier– high speed)

H . . . . . E3X-H11 (High gain amplifier)

NM . . . . E3X-NM (4 channel auto-tuning amplifier)

NT . . . . E3X-NT (Auto-tuning amplifier: general purpose)





NH . . . . E3X-NH (High-precision, auto-tuning amplifier)

NHB . . . E3X-NHB (High-precision, blue LED, auto-tuning amp)

NV . . . . E3X-NV21 (Water-resistant, red light source amplifier)

NVG . . . E3X-NVG21 (Water-resistant, green light source amp)

VG . . . . E3X-VG (Mark sensing amplifier)

Application	Features	Appearance	Type	Detection distance	Min. detectable object (opaque)	Part number
Long distance	Built-in lens provides long sensing distance; each sensing head has two 3.2 mm screw mounting holes; 25 mm bending radius; 1 mm ID fiber	 2 m (6.56 ft) length	A	900 mm	0.2 mm dia.	<b>E32-T14</b> 
			DA-HS	1,250 mm	_____	
			DA-LD	4,000 mm	_____	
			DA-SM	3,400 mm	0.01 mm dia.	
			F	380 mm	0.2 mm dia.	
			H	1,800 mm	0.2 mm dia.	
			NH	1,800 mm	0.08 mm dia.	
			NHB	200mm	0.08 mm dia.	
			NM	1,000 mm	0.2 mm dia.	
			NT	1,070 mm	0.2 mm dia.	
			NV	1,070 mm	0.2 mm dia.	
			NVG	80 mm	0.2 mm dia.	
			VG	80 mm	0.2 mm dia.	
Long distance	Space-saving mounting; 25 mm bending radius; 1 mm ID fiber	 3 mm (0.12 in) dia. x 35 mm (1.38 in) L 2 m (6.56 ft) length	A	120 mm	0.1 mm dia.	<b>E32-T14L</b> 
			DA-HS	170 mm	_____	
			DA-LD	570 mm	_____	
			DA-SM	460 mm	0.01 mm dia.	
			F	30 mm	0.2 mm dia.	
			H	240 mm	0.2 mm dia.	
			NH	240 mm	0.08 mm dia.	
			NHB	30 mm	0.08 mm dia.	
			NM	130 mm	0.3 mm dia.	
			NT	140 mm	0.2 mm dia.	
			NV	140 mm	0.2 mm dia.	
			NVG	10 mm	0.1 mm dia.	
			VG	10 mm	0.1 mm dia.	



## ■ THROUGH-BEAM, SIDE BEAM TYPE (CONT.)

The table specifies the sensing characteristics of each fiber when used with the following amplifiers:

### Legend:

A . . . . . E3X-A (General purpose amplifier)

DA-HS . E3X-DA (Digital amplifier– high speed mode)

DA-LD . E3X-DA (Digital amplifier– long distance mode)

DA-SM . E3X-DA (Digital amplifier– standard distance mode)

F . . . . . E3X-F (High performance amplifier– high speed)

H . . . . . E3X-H11 (High gain amplifier)

NM . . . . E3X-NM (4 channel auto-tuning amplifier)

NT . . . . E3X-NT (Auto-tuning amplifier: general purpose)



NH . . . . E3X-NH (High-precision, auto-tuning amplifier)

NHB . . . E3X-NHB (High-precision, blue LED, auto-tuning amp)

NV . . . . E3X-NV21 (Water-resistant, red light source amplifier)

NVG . . . E3X-NVG21 (Water-resistant, green light source amp)

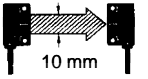
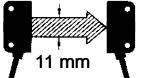
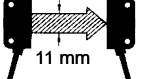
VG . . . . E3X-VG (Mark sensing amplifier)

Application	Features	Appearance	Type	Detection distance	Min. detectable object (opaque)	Part number
Area sensing	10 mm wide beam, long sensing distance; 25 mm bending radius; 1 mm ID fiber; includes 0.5 mm and 1 mm slit masks	 2 m (6.56 ft) length	A	750 mm	6.0 mm dia.*	<b>E32-T16</b> 
			DA-HS	1,000 mm	_____	
			DA-LD	3,500 mm	_____	
			DA-SM	2,800 mm	0.6 mm dia.	
			F	330 mm	7.0 mm dia.*	
			H	1,500 mm	6.0 mm dia.*	
			NH	1,500 mm	2.0 mm dia.*	
			NHB	700 mm	2.0 mm dia.*	
			NM	1,000 mm	5.0 mm dia.*	
			NT	1,070 mm	5.0 mm dia.*	
			NV	1,070 mm	5.0 mm dia.*	
			NVG	150 mm	7.0 mm dia.*	
			VG	150 mm	7.0 mm dia.*	
Area sensing	11 mm wide beam; flexible cable allows 10 mm bending radius; 1 mm ID fiber; includes 0.5 mm and 1 mm slit masks	 2 m (6.56 ft) length	A	300 mm	2.0 mm dia.*	<b>E32-T16P</b> 
			DA-HS	420 mm	_____	
			DA-LD	1,400 mm	_____	
			DA-SM	1,100 mm	0.2 mm dia.	
			F	Contact Omron	Contact Omron	
			H	Contact Omron	Contact Omron	
			NH	600 mm	0.4 mm dia.*	
			NHB	Contact Omron	Contact Omron	
			NM	400 mm	1.0 mm dia.*	
			NT	480 mm	1.3 mm dia.*	
			NV	480 mm	1.3 mm dia.*	
			NVG	Contact Omron	Contact Omron	
			VG	Contact Omron	Contact Omron	

Note: \*This value was measured at a sensing distance of 100 mm.

## ■ THROUGH-BEAM, SIDE BEAM TYPE (CONT.)

The table specifies the sensing characteristics of each fiber when used with the following amplifiers:

### Legend:

A . . . . . E3X-A (General purpose amplifier)

DA-HS . E3X-DA (Digital amplifier– high speed mode)

DA-LD . E3X-DA (Digital amplifier– long distance mode)

DA-SM . E3X-DA (Digital amplifier– standard distance mode)

F . . . . . E3X-F (High performance amplifier– high speed)

H . . . . . E3X-H11 (High gain amplifier)

NM . . . . E3X-NM (4 channel auto-tuning amplifier)

NT . . . . E3X-NT (Auto-tuning amplifier: general purpose)



NH . . . . E3X-NH (High-precision, auto-tuning amplifier)

NHB . . . E3X-NHB (High-precision, blue LED, auto-tuning amp)

NV . . . . E3X-NV21 (Water-resistant, red light source amplifier)

NVG . . . E3X-NVG21 (Water-resistant, green light source amp)

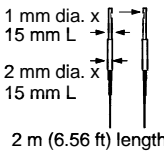
VG . . . . E3X-VG (Mark sensing amplifier)

Application	Features	Appearance	Type	Detection distance	Min. detectable object (opaque)	Part number
Small objects; side view sensing	Suitable for detecting minute objects; 304 stainless steel needle tip; 25 mm bending radius; 0.5 mm ID fiber	 <p>1 mm dia. x 15 mm L 2 mm dia. x 15 mm L 2 m (6.56 ft) length</p>	A	45 mm	0.1 mm dia.	<b>E32-T24</b> 
			DA-HS	55 mm	_____	
			DA-LD	150 mm	_____	
			DA-SM	130 mm	0.01 mm dia.	
			F	15 mm	0.3 mm dia.	
			H	90 mm	0.1 mm dia.	
			NH	90 mm	0.04 mm dia.	
			NHB	Contact Omron	Contact Omron	
			NM	45 mm	0.2 mm dia.	
			NT	48 mm	0.1 mm dia.	
			NV	48 mm	0.1 mm dia.	
			NVG	2 mm	0.2 mm dia.	
			VG	2 mm	0.2 mm dia.	

## ■ THROUGH-BEAM, HIGH TEMPERATURE TYPE

The table specifies the sensing characteristics of each fiber when used with the following amplifiers:

### Legend:

A . . . . . E3X-A (General purpose amplifier)

DA-HS . E3X-DA (Digital amplifier– high speed mode)

DA-LD . E3X-DA (Digital amplifier– long distance mode)

DA-SM . E3X-DA (Digital amplifier– standard distance mode)

F . . . . . E3X-F (High performance amplifier– high speed)

H . . . . . E3X-H11 (High gain amplifier)

NM . . . . E3X-NM (4 channel auto-tuning amplifier)

NT . . . . E3X-NT (Auto-tuning amplifier: general purpose)



NH . . . . E3X-NH (High-precision, auto-tuning amplifier)

NHB . . . E3X-NHB (High-precision, blue LED, auto-tuning amp)

NV . . . . E3X-NV21 (Water-resistant, red light source amplifier)

NVG . . . E3X-NVG21 (Water-resistant, green light source amp)

VG . . . . E3X-VG (Mark sensing amplifier)

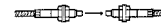
Application	Features	Appearance	Type	Detection distance	Min. detectable object (opaque)	Part number
Heat resistant	Resists 150°C; fiber sheath material: <b>fluororesin</b> . Operating ambient temperature: –40°C to 150°C (–40°F to 302°F); 1.5 mm ID fiber	 M4 threaded head x 17 mm (0.67 in) L 2 m (6.56 ft) length	A	200 mm	1.0 mm dia.	<b>E32-T51</b> 
			DA-HS	280 mm	_____	
			DA-LD	950 mm	_____	
			DA-SM	760 mm	0.01 mm dia.	
			F	80 mm	1.0 mm dia.	
			H	400 mm	1.0 mm dia.	
			NH	400 mm	0.4 mm dia.	
			NHB	35 mm	0.4 mm dia.	
			NM	300 mm	0.4 mm dia.	
			NT	320 mm	0.3 mm dia.	
			NV	320 mm	0.3 mm dia.	
			NVG	20 mm	1.0 mm dia.	
			VG	20 mm	1.0 mm dia.	
Heat resistant	Resists 300°C, with spiral tube; high <b>mechanical strength</b> ; fiber sheath material: <b>stainless steel</b> . Operating ambient temperature: –40°C to 300°C (–40°F to 572°F); 1 mm ID fiber	 M4 threaded head x 20 mm (0.79 in) L 2 m (6.56 ft) length	A	150 (1,500*) mm	0.2 mm dia.	<b>E32-T61</b>
			DA-HS	170 (1,300*) mm	_____	
			DA-LD	570 (4,000**) mm	_____	
			DA-SM	450 (3,400*) mm	0.01 mm dia.	
			F	60 (450*) mm	0.5 mm dia.	
			H	300 (3,000*) mm	0.3 mm dia.	
			NH	300 (3,000*) mm	0.12 mm dia.	
			NHB	Contact Omron	Contact Omron	
			NM	180 (2,000*) mm	0.2 mm dia.	
			NT	190 (2,100*) mm	0.15 mm dia.	
			NV	190 (2,100*) mm	0.15 mm dia.	
			NVG	18 (130*) mm	0.5 mm dia.	
			VG	18 (130*) mm	0.5 mm dia.	

Note: \* Value in parentheses represents the sensing distance of the fiber when the E39-F1 lens is attached to its tip.

\*\*Value in parentheses is based on each fiber having a cable length of 2,000 mm.

## ■ THROUGH-BEAM, SPECIAL PURPOSE TYPE

The table specifies the sensing characteristics of each fiber when used with the following amplifiers:

### Legend:

A . . . . . E3X-A (General purpose amplifier)

DA-HS . E3X-DA (Digital amplifier– high speed mode)

DA-LD . E3X-DA (Digital amplifier– long distance mode)

DA-SM . E3X-DA (Digital amplifier– standard distance mode)

F . . . . . E3X-F (High performance amplifier– high speed)

H . . . . . E3X-H11 (High gain amplifier)

NM . . . . E3X-NM (4 channel auto-tuning amplifier)

NT . . . . E3X-NT (Auto-tuning amplifier: general purpose)



NH . . . . E3X-NH (High-precision, auto-tuning amplifier)

NHB . . . E3X-NHB (High-precision, blue LED, auto-tuning amp)

NV . . . . E3X-NV21 (Water-resistant, red light source amplifier)

NVG . . . E3X-NVG21 (Water-resistant, green light source amp)

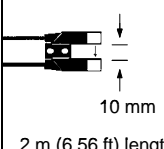
VG . . . . E3X-VG (Mark sensing amplifier)

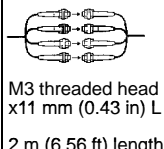
Application	Features	Appearance	Type	Detection distance	Min. detectable object (opaque)	Part number
Mark/edge detection	Ideal for mark sensing or belt alignment; no optical axis adjustment required; easy to mount; 1 mm ID fiber	 <p>10 mm 2 m (6.56 ft) length</p>	A	10 mm	0.5 mm dia.	<b>E32-G14</b> 
			DA-HS	10 mm	_____	
			DA-LD	10 mm	_____	
			DA-SM	10 mm	0.16 mm dia.	
			F	10 mm	0.5 mm dia.	
			H	10 mm	Contact Omron	
			NH	10 mm	Contact Omron	
			NHB	Contact Omron	Contact Omron	
			NM	10 mm	0.7 mm dia.	
			NT	10 mm	0.4 mm dia.	
			NV	10 mm	0.4 mm dia.	
			NVG	10 mm	0.6 mm dia.	
			VG	10 mm	0.6 mm dia.	
Area sensing	Use with E3XA-CC4A for shape recognition; 0.5 mm ID fiber	 <p>M3 threaded head x11 mm (0.43 in) L 2 m (6.56 ft) length</p>	A	150 mm	0.3 mm dia.	<b>E32-M21</b>
			DA-HS	250 mm	_____	
			DA-LD	700 mm	_____	
			DA-SM	610 mm	0.01 mm dia.	
			F	65 mm	0.3 mm dia.	
			H	300 mm	0.4 mm dia.	
			NH	300 mm	0.04 mm dia.	
			NHB	Contact Omron	Contact Omron	
			NM	200 mm	0.2 mm dia.	
			NT	210 mm	0.1 mm dia.	
			NV	210 mm	0.1 mm dia.	
			NVG	20 mm	0.3 mm dia.	
			VG	20 mm	0.3 mm dia.	

## ■ THROUGH-BEAM, SPECIAL PURPOSE TYPE (CONT.)

The table specifies the sensing characteristics of each fiber when used with the following amplifiers:

### Legend:

A . . . . . E3X-A (General purpose amplifier)

DA-HS . E3X-DA (Digital amplifier– high speed mode)

DA-LD . E3X-DA (Digital amplifier– long distance mode)

DA-SM . E3X-DA (Digital amplifier– standard distance mode)

F . . . . . E3X-F (High performance amplifier– high speed)

H . . . . . E3X-H11 (High gain amplifier)

NM . . . . E3X-NM (4 channel auto-tuning amplifier)

NT . . . . E3X-NT (Auto-tuning amplifier: general purpose)





NH . . . . E3X-NH (High-precision, auto-tuning amplifier)

NHB . . . E3X-NHB (High-precision, blue LED, auto-tuning amp)

NV . . . . E3X-NV21 (Water-resistant, red light source amplifier)

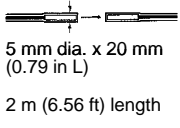
NVG . . . E3X-NVG21 (Water-resistant, green light source amp)

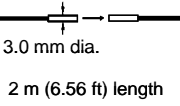
VG . . . . E3X-VG (Mark sensing amplifier)

Application	Features	Appearance	Type	Detection distance	Min. detectable object (opaque)	Part number
Chemical resistant	Teflon-coated sensing head for harsh chemical environments. Operating ambient temperature: –30°C to 70°C (–22°F to 158°F); 1 mm ID fiber; 40 mm bending radius	 <p>5 mm dia. x 20 mm (0.79 in L) 2 m (6.56 ft) length</p>	A	800 mm	0.9 mm dia.	E32-T12F 
			DA-HS	1,100 mm	_____	
			DA-LD	3,800 mm	_____	
			DA-SM	3,000 mm	0.01 mm dia.	
			F	300 mm	0.7 mm dia.	
			H	1,600 mm	0.7 mm dia.	
			NH	1,600 mm	0.12 mm dia.	
			NHB	220 mm	0.12 mm dia.	
			NM	1,000 mm	0.3 mm dia.	
			NT	1,070 mm	0.3 mm dia.	
			NV	1,070 mm	0.3 mm dia.	
			NVG	70 mm	0.6 mm dia.	
			VG	70 mm	0.6 mm dia.	
Wafer detection	Ultra narrow beam is ideal for sensing silicon wafers; 10 mm bending radius	 <p>3.0 mm dia. 2 m (6.56 ft) length</p>	A	Contact Omron	Contact Omron	E32-T22S 
			DA-HS	700 mm	_____	
			DA-LD	2,300 mm	_____	
			DA-SM	1,900 mm	0.01 mm dia.	
			F	Contact Omron	Contact Omron	
			H	1,000 mm	Contact Omron	
			NH	1,000 mm	0.08 mm dia.	
			NHB	Contact Omron	Contact Omron	
			NM	650 mm	0.4 mm dia.	
			NT	650 mm	0.2 mm dia.	
			NV	650 mm	0.2 mm dia.	
			NVG	Contact Omron	Contact Omron	
			VG	Contact Omron	Contact Omron	

## ■ THROUGH-BEAM, SPECIAL PURPOSE TYPE (CONT.)

The table specifies the sensing characteristics of each fiber when used with the following amplifiers:

### Legend:

A . . . . . E3X-A (General purpose amplifier)

DA-HS . E3X-DA (Digital amplifier– high speed mode)

DA-LD . E3X-DA (Digital amplifier– long distance mode)

DA-SM . E3X-DA (Digital amplifier– standard distance mode)

F . . . . . E3X-F (High performance amplifier– high speed)

H . . . . . E3X-H11 (High gain amplifier)

NM . . . . E3X-NM (4 channel auto-tuning amplifier)

NT . . . . E3X-NT (Auto-tuning amplifier: general purpose)





NH . . . . E3X-NH (High-precision, auto-tuning amplifier)

NHB . . . E3X-NHB (High-precision, blue LED, auto-tuning amp)

NV . . . . E3X-NV21 (Water-resistant, red light source amplifier)

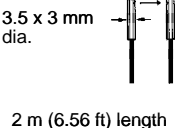
NVG . . . E3X-NVG21 (Water-resistant, green light source amp)

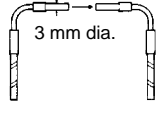
VG . . . . E3X-VG (Mark sensing amplifier)

Application	Features	Appearance	Type	Detection distance	Min. detectable object (opaque)	Part number
Wafer detection	Side view with narrow field of vision; 10 mm bending radius	 <p>3.5 x 3 mm dia. 2 m (6.56 ft) length</p>	A	Contact Omron	Contact Omron	<b>E32-T24S</b> 
			DA-HS	500 mm	_____	
			DA-LD	1,700 mm	_____	
			DA-SM	1,300 mm	0.01 mm dia.	
			F	Contact Omron	Contact Omron	
			H	700 mm	Contact Omron	
			NH	700 mm	0.08 mm dia.	
			NHB	Contact Omron	Contact Omron	
			NM	450 mm	0.4 mm dia.	
			NT	480 mm	0.2 mm dia.	
			NV	480 mm	0.2 mm dia.	
			NVG	Contact Omron	Contact Omron	
			VG	Contact Omron	Contact Omron	
Heat resistant	Side view with stainless steel spiral tube sheath; resists 200°C (392°F) at the fiber tip; 25 mm bending radius	 <p>3 mm dia. 2 m (6.56 ft) length</p>	A	Contact Omron	Contact Omron	<b>E32-T84S</b> 
			DA-HS	500 mm	_____	
			DA-LD	1,700 mm	_____	
			DA-SM	1,300 mm	0.01 mm dia.	
			F	Contact Omron	Contact Omron	
			H	Contact Omron	Contact Omron	
			NH	700 mm	0.12 mm dia.	
			NHB	Contact Omron	Contact Omron	
			NM	450 mm	0.3 mm dia.	
			NT	480 mm	0.3 mm dia.	
			NV	480 mm	0.3 mm dia.	
			NVG	Contact Omron	Contact Omron	
			VG	Contact Omron	Contact Omron	

## ■ DIFFUSE, GENERAL PURPOSE TYPE

The table specifies the sensing characteristics of each fiber when used with the following amplifiers:

### Legend:

A . . . . . E3X-A (General purpose amplifier)

DA-HS . E3X-DA (Digital amplifier– high speed mode)

DA-LD . E3X-DA (Digital amplifier– long distance mode)

DA-SM . E3X-DA (Digital amplifier– standard distance mode)

F . . . . . E3X-F (High performance amplifier– high speed)

H . . . . . E3X-H11 (High gain amplifier)

NM . . . . E3X-NM (4 channel auto-tuning amplifier)

NT . . . . E3X-NT (Auto-tuning amplifier: general purpose)





NH . . . . E3X-NH (High-precision, auto-tuning amplifier)

NHB . . . E3X-NHB (High-precision, blue LED, auto-tuning amp)

NV . . . . E3X-NV21 (Water-resistant, red light source amplifier)

NVG . . . E3X-NVG21 (Water-resistant, green light source amp)

VG . . . . E3X-VG (Mark sensing amplifier)

Application	Features	Appearance	Type	Detection distance (see note)	Min. detectable object (gold wire)	Part number
High accuracy positioning	Concentric beam: emitter in the center and a ring of 16 receivers in the 2.5 mm dia. tip; 25 mm bending radius; 1 mm ID fiber	 M6 threaded head x 20 mm (0.79 in) L 2 m (6.56 ft) length	A	75 mm	0.03 mm dia.	<b>E32-CC200</b> 
			DA-HS	100 mm	_____	
			DA-LD	400 mm	_____	
			DA-SM	300 mm	0.01 mm dia.	
			F	33 mm	0.03 mm dia.	
			H	150 mm	0.015 mm dia.	
			NH	150 mm	0.012 mm dia.	
			NHB	20 mm	0.012 mm dia.	
			NM	100 mm	0.015 mm dia.	
			NT	110 mm	0.012 mm dia.	
			NV	110 mm	0.012 mm dia.	
			NVG	10 mm	0.5 mm dia.	
			VG	10 mm	0.5 mm dia.	
Flexible (resists breaking)	Thin fiber for small object detection, ultra flexible cable; 4 mm bending radius; 0.25 mm ID fiber	 M6 threaded head x 17 mm (0.67 in) L 2 m (6.56 ft) length	A	45 mm	0.03 mm dia.	<b>E32-D11</b> 
			DA-HS	80 mm	_____	
			DA-LD	220 mm	_____	
			DA-SM	170 mm	0.01 mm dia.	
			F	20 mm	0.03 mm dia.	
			H	90 mm	0.015 mm dia.	
			NH	90 mm	0.012 mm dia.	
			NHB	12 mm	0.012 mm dia.	
			NM	60 mm	0.015 mm dia.	
			NT	65 mm	0.012 mm dia.	
			NV	65 mm	0.012 mm dia.	
			NVG	7 mm	0.5 mm dia.	
			VG	7 mm	0.5 mm dia.	

Note: Sensing distance is based on sensing a white paper that has 90% reflectivity.

## ■ DIFFUSE, GENERAL PURPOSE TYPE (CONT.)

The table specifies the sensing characteristics of each fiber when used with the following amplifiers:

### Legend:

A . . . . . E3X-A (General purpose amplifier)

DA-HS . E3X-DA (Digital amplifier– high speed mode)

DA-LD . E3X-DA (Digital amplifier– long distance mode)

DA-SM . E3X-DA (Digital amplifier– standard distance mode)

F . . . . . E3X-F (High performance amplifier– high speed)

H . . . . . E3X-H11 (High gain amplifier)

NM . . . . E3X-NM (4 channel auto-tuning amplifier)

NT . . . . E3X-NT (Auto-tuning amplifier: general purpose)





NH . . . . E3X-NH (High-precision, auto-tuning amplifier)

NHB . . . E3X-NHB (High-precision, blue LED, auto-tuning amp)

NV . . . . E3X-NV21 (Water-resistant, red light source amplifier)

NVG . . . E3X-NVG21 (Water-resistant, green light source amp)

VG . . . . E3X-VG (Mark sensing amplifier)

Application	Features	Appearance	Type	Detection distance (see note)	Min. detectable object (gold wire)	Part number
Long distance	Compact threaded sensing head; 25 mm bending radius; 1 mm ID fiber	 M6 threaded head x 17 mm (0.67 in) L  2 m (6.56 ft) length	A	100 mm	0.015 mm dia.	E32-D11L 
			DA-HS	150 mm	_____	
			DA-LD	500 mm	_____	
			DA-SM	400 mm	0.01 mm dia.	
			F	45 mm	0.2 mm dia.	
			H	200 mm	0.015 mm dia.	
			NH	200 mm	0.012 mm dia.	
			NHB	26 mm	0.012 mm dia.	
			NM	150 mm	0.015 mm dia.	
			NT	160 mm	0.012 mm dia.	
			NV	160 mm	0.012 mm dia.	
			NVG	10 mm	3.0 mm dia.	
			VG	10 mm	3.0 mm dia.	
Flexible (resists breaking)	High flexibility with 1 mm minimum bending radius	 M6 screw x 17 mm (0.67 in) L  2 m (6.56 ft) length	A	45 mm	0.03 mm dia.	E32-D11R 
			DA-HS	80 mm	_____	
			DA-LD	220 mm	_____	
			DA-SM	170 mm	0.01 mm dia.	
			F	Contact Omron	Contact Omron	
			H	Contact Omron	Contact Omron	
			NH	90 mm	0.02 mm dia.	
			NHB	Contact Omron	Contact Omron	
			NM	60 mm	0.02 mm dia.	
			NT	65 mm	0.02 mm dia.	
			NV	65 mm	0.02 mm dia.	
			NVG	45 mm	0.03 mm dia.	
			VG	45 mm	0.03 mm dia.	

Note: Sensing distance is based on sensing a white paper that has 90% reflectivity.



## ■ DIFFUSE, GENERAL PURPOSE TYPE (CONT.)

The table specifies the sensing characteristics of each fiber when used with the following amplifiers:

### Legend:

A . . . . . E3X-A (General purpose amplifier)

DA-HS . E3X-DA (Digital amplifier– high speed mode)

DA-LD . E3X-DA (Digital amplifier– long distance mode)

DA-SM . E3X-DA (Digital amplifier– standard distance mode)

F . . . . . E3X-F (High performance amplifier– high speed)

H . . . . . E3X-H11 (High gain amplifier)

NM . . . . E3X-NM (4 channel auto-tuning amplifier)

NT . . . . E3X-NT (Auto-tuning amplifier: general purpose)





NH . . . . E3X-NH (High-precision, auto-tuning amplifier)

NHB . . . E3X-NHB (High-precision, blue LED, auto-tuning amp)

NV . . . . E3X-NV21 (Water-resistant, red light source amplifier)

NVG . . . E3X-NVG21 (Water-resistant, green light source amp)

VG . . . . E3X-VG (Mark sensing amplifier)

Application	Features	Appearance	Type	Detection distance (see note)	Min. detectable object (gold wire)	Part number
Flexible (resists breaking)	Flexible thin fiber requires just 4 mm bending radius; mount on moving machinery sections; 0.25 mm ID fiber	 M3 threaded head x 11 mm (0.43 in) L  2 m (6.56 ft) length	A	7 mm	0.03 mm dia.	<b>E32-D21</b> 
			DA-HS	10 mm	_____	
			DA-LD	40 mm	_____	
			DA-SM	30 mm	0.01 mm dia.	
			F	3 mm	0.03 mm dia.	
			H	14 mm	0.015 mm dia.	
			NH	14 mm	0.012 mm dia.	
			NHB	Contact Omron	Contact Omron	
			NM	8 mm	0.015 mm dia.	
			NT	9 mm	0.012 mm dia.	
			NV	9 mm	0.012 mm dia.	
			NVG	1 mm	1.0 mm dia.	
VG	1 mm	1.0 mm dia.				
Long distance	Small sensing head is easy to mount; 25 mm bending radius	 M4 threaded head x 12 mm (0.47 in) L  2 m (6.56 ft) length	A	25 mm	0.03 mm dia.	<b>E32-D21L</b> 
			DA-HS	45 mm	_____	
			DA-LD	160 mm	_____	
			DA-SM	130 mm	0.01 mm dia.	
			F	11 mm	0.26 mm dia.	
			H	50 mm	0.015 mm dia.	
			NH	50 mm	0.012 mm dia.	
			NHB	Contact Omron	Contact Omron	
			NM	35 mm	0.015 mm dia.	
			NT	38 mm	0.012 mm dia.	
			NV	38 mm	0.012 mm dia.	
			NVG	1 mm	1.0 mm dia.	
VG	1 mm	1.0 mm dia.				

Note: Sensing distance is based on sensing a white paper that has 90% reflectivity.

## ■ DIFFUSE, GENERAL PURPOSE TYPE (CONT.)

The table specifies the sensing characteristics of each fiber when used with the following amplifiers:

### Legend:

A . . . . . E3X-A (General purpose amplifier)

DA-HS . E3X-DA (Digital amplifier– high speed mode)

DA-LD . E3X-DA (Digital amplifier– long distance mode)

DA-SM . E3X-DA (Digital amplifier– standard distance mode)

F . . . . . E3X-F (High performance amplifier– high speed)

H . . . . . E3X-H11 (High gain amplifier)

NM . . . . E3X-NM (4 channel auto-tuning amplifier)

NT . . . . E3X-NT (Auto-tuning amplifier: general purpose)





NH . . . . E3X-NH (High-precision, auto-tuning amplifier)

NHB . . . E3X-NHB (High-precision, blue LED, auto-tuning amp)

NV . . . . E3X-NV21 (Water-resistant, red light source amplifier)

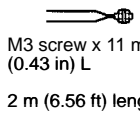
NVG . . . E3X-NVG21 (Water-resistant, green light source amp)

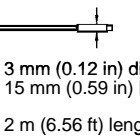
VG . . . . E3X-VG (Mark sensing amplifier)

Application	Features	Appearance	Type	Detection distance (see note)	Min. detectable object (gold wire)	Part number
Flexible (resists breaking)	Easy to mount sensing head with high flexibility cable; 1 mm bending radius	 <p>M3 screw x 11 mm (0.43 in) L 2 m (6.56 ft) length</p>	A	7 mm	0.03 mm dia.	<b>E32-D21R</b> 
			DA-HS	10 mm	_____	
			DA-LD	40 mm	_____	
			DA-SM	30 mm	0.01 mm dia.	
			F	Contact Omron	Contact Omron	
			H	Contact Omron	Contact Omron	
			NH	14 mm	0.02 mm dia.	
			NHB	NA	NA	
			NM	8 mm	0.02 mm dia.	
			NT	9 mm	0.02 mm dia.	
			NV	9 mm	0.02 mm dia.	
			NVG	NA	NA	
			VG	NA	NA	
Long distance	Small diameter head fits space-confined installations; 25 mm bending radius; 0.5 mm ID fiber	 <p>3 mm (0.12 in) dia. x 15 mm (0.59 in) L 2 m (6.56 ft) length</p>	A	25 mm	0.03 mm dia.	<b>E32-D22L</b> 
			DA-HS	45 mm	_____	
			DA-LD	160 mm	_____	
			DA-SM	130 mm	0.01 mm dia.	
			F	11 mm	0.26 mm dia.	
			H	50 mm	0.015 mm dia.	
			NH	50 mm	0.012 mm dia.	
			NHB	Contact Omron	Contact Omron	
			NM	35 mm	0.015 mm dia.	
			NT	38 mm	0.012 mm dia.	
			NV	38 mm	0.012 mm dia.	
			NVG	1 mm	1.0 mm dia.	
			VG	1 mm	1.0 mm dia.	

Note: Sensing distance is based on sensing a white paper that has 90% reflectivity.

## ■ DIFFUSE, GENERAL PURPOSE TYPE (CONT.)

The table specifies the sensing characteristics of each fiber when used with the following amplifiers:

### Legend:

A . . . . . E3X-A (General purpose amplifier)

DA-HS . E3X-DA (Digital amplifier– high speed mode)

DA-LD . E3X-DA (Digital amplifier– long distance mode)

DA-SM . E3X-DA (Digital amplifier– standard distance mode)

F . . . . . E3X-F (High performance amplifier– high speed)

H . . . . . E3X-H11 (High gain amplifier)

NM . . . . E3X-NM (4 channel auto-tuning amplifier)

NT . . . . E3X-NT (Auto-tuning amplifier: general purpose)





NH . . . . E3X-NH (High-precision, auto-tuning amplifier)

NHB . . . E3X-NHB (High-precision, blue LED, auto-tuning amp)

NV . . . . E3X-NV21 (Water-resistant, red light source amplifier)

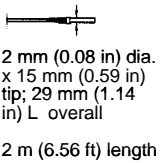
NVG . . . E3X-NVG21 (Water-resistant, green light source amp)

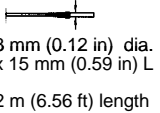
VG . . . . E3X-VG (Mark sensing amplifier)

Application	Features	Appearance	Type	Detection distance (see note)	Min. detectable object (gold wire)	Part number
Precise positioning	Concentric beam: light source in the center with a ring of 4 receivers in 2 mm dia. tip; 25 mm bending radius; 0.25 mm ID fiber		A	20 mm	0.03 mm dia.	<b>E32-D32</b> 
			DA-HS	25 mm	_____	
			DA-LD	100 mm	_____	
			DA-SM	75 mm	0.01 mm dia.	
			F	9 mm	0.03 mm dia.	
			H	40 mm	0.015 mm dia.	
			NH	40 mm	0.012 mm dia.	
			NHB	Contact Omron	Contact Omron	
			NM	30 mm	0.015 mm dia.	
			NT	33 mm	0.012 mm dia.	
			NV	33 mm	0.012 mm dia.	
			NVG	2.5 mm	0.5 mm dia.	
VG	2.5 mm	0.5 mm dia.				
Coaxial diffuse for precise positioning	Concentric beam: light source in the center with a ring of 16 receivers in 3 mm dia. tip; 25 mm bending radius		A	40 mm	0.04 mm dia.	<b>E32-D32L</b> 
			DA-HS	50 mm	0.01 mm dia.	
			DA-LD	200 mm	0.01 mm dia.	
			DA-SM	150 mm	0.01 mm dia.	
			F	11 mm	1.1 mm dia.,	
			H	80 mm	0.015 mm dia.	
			NH	80 mm	0.012 mm dia.	
			NHB	Contact Omron	Contact Omron	
			NM	60 mm	0.04 mm dia.	
			NT	65 mm	0.012 mm dia.	
			NV	65 mm	0.012 mm dia.	
			NVG	4 mm	1 mm dia.	
VG	4 mm	1 mm dia.				

Note: Sensing distance is based on sensing a white paper that has 90% reflectivity.

## ■ DIFFUSE, GENERAL PURPOSE TYPE (CONT.)

The table specifies the sensing characteristics of each fiber when used with the following amplifiers:

### Legend:

A . . . . . E3X-A (General purpose amplifier)

DA-HS . E3X-DA (Digital amplifier– high speed mode)

DA-LD . E3X-DA (Digital amplifier– long distance mode)

DA-SM . E3X-DA (Digital amplifier– standard distance mode)

F . . . . . E3X-F (High performance amplifier– high speed)

H . . . . . E3X-H11 (High gain amplifier)

NM . . . . E3X-NM (4 channel auto-tuning amplifier)

NT . . . . E3X-NT (Auto-tuning amplifier: general purpose)





NH . . . . E3X-NH (High-precision, auto-tuning amplifier)

NHB . . . E3X-NHB (High-precision, blue LED, auto-tuning amp)

NV . . . . E3X-NV21 (Water-resistant, red light source amplifier)

NVG . . . E3X-NVG21 (Water-resistant, green light source amp)

VG . . . . E3X-VG (Mark sensing amplifier)

Application	Features	Appearance	Type	Detection distance (see note)	Min. detectable object (gold wire)	Part number
General purpose	Compact threaded head; short cable length; 25 mm bending radius	 M6 threaded head x 14 mm (0.55 in) L  50 cm (19 in) length	A	75 mm	0.015 mm dia.	<b>E32-DC50</b> 
			DA-HS	Contact Omron	Contact Omron	
			DA-LD	Contact Omron	Contact Omron	
			DA-SM	Contact Omron	Contact Omron	
			F	33 mm	0.015 mm dia.	
			H	150 mm	0.015 mm dia.	
			NH	Contact Omron	Contact Omron	
			NHB	Contact Omron	Contact Omron	
			NM	Contact Omron	Contact Omron	
			NT	Contact Omron	Contact Omron	
			NV	Contact Omron	Contact Omron	
			NVG	Contact Omron	Contact Omron	
			VG	10 mm	0.2 mm dia.	
General purpose	Compact threaded head; 25 mm bending radius; 1 mm ID fiber	 M6 threaded head x 14 mm (0.55 in) L  2 m (6.56 ft) length	A	75 mm	0.015 mm dia.	<b>E32-DC200</b> 
			DA-HS	100 mm	—————	
			DA-LD	400 mm	—————	
			DA-SM	300 mm	0.01 mm dia.	
			F	33 mm	0.015 mm dia.	
			H	150 mm	0.015 mm dia.	
			NH	150 mm	0.012 mm dia.	
			NHB	20 mm	0.012 mm dia.	
			NM	100 mm	0.015 mm dia.	
			NT	110 mm	0.012 mm dia.	
			NV	110 mm	0.012 mm dia.	
			NVG	10 mm	0.2 mm dia.	
			VG	10 mm	0.2 mm dia.	

Note: Sensing distance is based on sensing a white paper that has 90% reflectivity.

## ■ DIFFUSE, GENERAL PURPOSE TYPE (CONT.)

The table specifies the sensing characteristics of each fiber when used with the following amplifiers:

### Legend:

A . . . . . E3X-A (General purpose amplifier)

DA-HS . E3X-DA (Digital amplifier– high speed mode)

DA-LD . E3X-DA (Digital amplifier– long distance mode)

DA-SM . E3X-DA (Digital amplifier– standard distance mode)

F . . . . . E3X-F (High performance amplifier– high speed)

H . . . . . E3X-H11 (High gain amplifier)

NM . . . . E3X-NM (4 channel auto-tuning amplifier)

NT . . . . E3X-NT (Auto-tuning amplifier: general purpose)





NH . . . . E3X-NH (High-precision, auto-tuning amplifier)

NHB . . . E3X-NHB (High-precision, blue LED, auto-tuning amp)

NV . . . . E3X-NV21 (Water-resistant, red light source amplifier)

NVG . . . E3X-NVG21 (Water-resistant, green light source amp)

VG . . . . E3X-VG (Mark sensing amplifier)

Application	Features	Appearance	Type	Detection distance (see note)	Min. detectable object (gold wire)	Part number
General purpose	Coiled cable ideal for moving parts; 25 mm bending radius; 1 mm ID fiber	 M6 threaded head x 17 mm (0.67 in) L  Coiled 64 cm (2.1 ft) L; 2 m (6.56 ft) extended	A	22 mm	0.03 mm dia.	<b>E32-DC200C</b> 
			DA-HS	Contact Omron	Contact Omron	
			DA-LD	Contact Omron	Contact Omron	
			DA-SM	Contact Omron	Contact Omron	
			F	10 mm	0.03 mm dia.	
			H	44 mm	0.015 mm dia.	
			NH	44 mm	0.012 mm dia.	
			NHB	Contact Omron	Contact Omron	
			NM	30 mm	0.015 mm dia.	
			NT	33 mm	0.012 mm dia.	
			NV	33 mm	0.012 mm dia.	
			NVG	2.5 mm	1.0 mm dia.	
			VG	2.5 mm	1.0 mm dia.	
General purpose	Thin fiber with small easy-to-mount head.; 25 mm bending radius; 0.5 mm ID fiber	 M3 threaded head x 11 mm (0.43 in) L  2 m (6.56 ft) length	A	18 mm	0.03 mm dia.	<b>E32-DC200E</b> 
			DA-HS	30 mm	_____	
			DA-LD	100 mm	_____	
			DA-SM	80 mm	0.01 mm dia.	
			F	8 mm	0.03 mm dia.	
			H	36 mm	0.015 mm dia.	
			NH	36 mm	0.012 mm dia.	
			NHB	Contact Omron	Contact Omron	
			NM	20 mm	0.015 mm dia.	
			NT	22 mm	0.012 mm dia.	
			NV	22 mm	0.012 mm dia.	
			NVG	2 mm	1.0 mm dia.	
			VG	2 mm	1.0 mm dia.	

Note: Sensing distance is based on sensing a white paper that has 90% reflectivity.

## ■ DIFFUSE, GENERAL PURPOSE TYPE (CONT.)

The table specifies the sensing characteristics of each fiber when used with the following amplifiers:

### Legend:

A . . . . . E3X-A (General purpose amplifier)

DA-HS . E3X-DA (Digital amplifier– high speed mode)

DA-LD . E3X-DA (Digital amplifier– long distance mode)

DA-SM . E3X-DA (Digital amplifier– standard distance mode)

F . . . . . E3X-F (High performance amplifier– high speed)

H . . . . . E3X-H11 (High gain amplifier)

NM . . . . E3X-NM (4 channel auto-tuning amplifier)

NT . . . . E3X-NT (Auto-tuning amplifier: general purpose)





NH . . . . E3X-NH (High-precision, auto-tuning amplifier)

NHB . . . E3X-NHB (High-precision, blue LED, auto-tuning amp)

NV . . . . E3X-NV21 (Water-resistant, red light source amplifier)

NVG . . . E3X-NVG21 (Water-resistant, green light source amp)

VG . . . . E3X-VG (Mark sensing amplifier)

Application	Features	Appearance	Type	Detection distance (see note)	Min. detectable object (gold wire)	Part number
General purpose	Compact threaded head; 25 mm bending radius; 1 mm ID fiber	 M6 threaded head x 14 mm (0.55 in) L  5 m (16.4 ft) length	A	75 mm	0.015 mm dia.	<b>E32-DC500</b> 
			DA-HS	Contact Omron	Contact Omron	
			DA-LD	Contact Omron	Contact Omron	
			DA-SM	Contact Omron	Contact Omron	
			F	33 mm	0.015 mm dia.	
			H	150 mm	0.015 mm dia.	
			NH	Contact Omron	Contact Omron	
			NHB	Contact Omron	Contact Omron	
			NM	Contact Omron	Contact Omron	
			NT	Contact Omron	Contact Omron	
			NV	Contact Omron	Contact Omron	
			NVG	Contact Omron	Contact Omron	
			VG	10 mm	0.2 mm dia.	
General purpose	Compact threaded head; 25 mm bending radius; 1 mm ID fiber	 M6 threaded head x 14 mm (0.55 in) L  10 m (32.8 ft) length	A	75 mm	0.015 mm dia.	<b>E32-DC1000</b> 
			DA-HS	Contact Omron	Contact Omron	
			DA-LD	Contact Omron	Contact Omron	
			DA-SM	Contact Omron	Contact Omron	
			F	33 mm	0.015 mm dia.	
			H	150 mm	0.015 mm dia.	
			NH	Contact Omron	Contact Omron	
			NHB	Contact Omron	Contact Omron	
			NM	Contact Omron	Contact Omron	
			NT	Contact Omron	Contact Omron	
			NV	Contact Omron	Contact Omron	
			NVG	Contact Omron	Contact Omron	
			VG	10 mm	0.2 mm dia.	

Note: Sensing distance is based on sensing a white paper that has 90% reflectivity.

## ■ DIFFUSE, ARMORED TYPE

The table specifies the sensing characteristics of each fiber when used with the following amplifiers:

### Legend:

A . . . . . E3X-A (General purpose amplifier)

DA-HS . E3X-DA (Digital amplifier– high speed mode)

DA-LD . E3X-DA (Digital amplifier– long distance mode)

DA-SM . E3X-DA (Digital amplifier– standard distance mode)

F . . . . . E3X-F (High performance amplifier– high speed)

H . . . . . E3X-H11 (High gain amplifier)

NM . . . . E3X-NM (4 channel auto-tuning amplifier)

NT . . . . E3X-NT (Auto-tuning amplifier: general purpose)

NH . . . . E3X-NH (High-precision, auto-tuning amplifier)

NHB . . . E3X-NHB (High-precision, blue LED, auto-tuning amp)

NV . . . . E3X-NV21 (Water-resistant, red light source amplifier)

NVG . . . E3X-NVG21 (Water-resistant, green light source amp)

VG . . . . E3X-VG (Mark sensing amplifier)

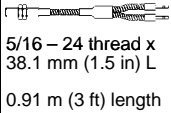
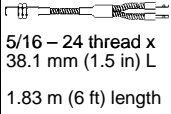
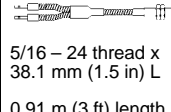
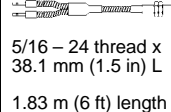
Application	Features	Appearance	Type	Detection distance (see note)	Min. detectable object (gold wire)	Part number
General purpose	Can withstand temperatures to 150°C (302°F)	 5/16 – 24 thread x 38.1 mm (1.5 in) L  0.91 m (3 ft) length	A	80 mm	0.03 mm dia.	<b>E32-UDAT1-3F</b>
			DA-HS	Contact Omron	Contact Omron	
			DA-LD	Contact Omron	Contact Omron	
			DA-SM	Contact Omron	Contact Omron	
			F	Contact Omron	Contact Omron	
			H	Contact Omron	Contact Omron	
			NH	Contact Omron	Contact Omron	
			NHB	Contact Omron	Contact Omron	
			NM	Contact Omron	Contact Omron	
			NT	Contact Omron	Contact Omron	
			NV	Contact Omron	Contact Omron	
			NVG	Contact Omron	Contact Omron	
VG	Contact Omron	Contact Omron				
General purpose	Can withstand temperatures to 150°C (302°F)	 5/16 – 24 thread x 38.1 mm (1.5 in) L  1.83 m (6 ft) length	A	65 mm	0.03 mm dia.	<b>E32-UDAT1-6F</b>
			DA-HS	Contact Omron	Contact Omron	
			DA-LD	Contact Omron	Contact Omron	
			DA-SM	Contact Omron	Contact Omron	
			F	Contact Omron	Contact Omron	
			H	Contact Omron	Contact Omron	
			NH	Contact Omron	Contact Omron	
			NHB	Contact Omron	Contact Omron	
			NM	Contact Omron	Contact Omron	
			NT	Contact Omron	Contact Omron	
			NV	Contact Omron	Contact Omron	
			NVG	Contact Omron	Contact Omron	
VG	Contact Omron	Contact Omron				
General purpose	Can withstand temperatures to 200°C (392°F)	 5/16 – 24 thread x 38.1 mm (1.5 in) L  0.91 m (3 ft) length	E3JU-X only	90 mm	0.05 mm dia.	<b>E32-UDBT1-3F</b>
General purpose	Can withstand temperatures to 200°C (392°F)	 5/16 – 24 thread x 38.1 mm (1.5 in) L  1.83 m (6 ft) length	E3JU-X only	80 mm	0.05 mm dia.	<b>E32-UDBT1-6F</b>

## ■ DIFFUSE, PROBE TYPE

The table specifies the sensing characteristics of each fiber when used with the following amplifiers:

### Legend:

A . . . . . E3X-A (General purpose amplifier)

DA-HS . E3X-DA (Digital amplifier– high speed mode)

DA-LD . E3X-DA (Digital amplifier– long distance mode)

DA-SM . E3X-DA (Digital amplifier– standard distance mode)

F . . . . . E3X-F (High performance amplifier– high speed)

H . . . . . E3X-H11 (High gain amplifier)

NM . . . . E3X-NM (4 channel auto-tuning amplifier)

NT . . . . E3X-NT (Auto-tuning amplifier: general purpose)





NH . . . . E3X-NH (High-precision, auto-tuning amplifier)

NHB . . . E3X-NHB (High-precision, blue LED, auto-tuning amp)

NV . . . . E3X-NV21 (Water-resistant, red light source amplifier)

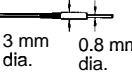
NVG . . . E3X-NVG21 (Water-resistant, green light source amp)

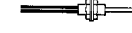
VG . . . . E3X-VG (Mark sensing amplifier)

Application	Features	Appearance	Type	Detection distance (see note)	Min. detectable object (gold wire)	Part number
Needle probe	Super thin tip for minute object detection; 25 mm bending radius; 0.25 mm ID fiber	 3 mm dia. 0.8 mm dia. 2 m (6.56 ft) length	A	5 mm	0.015 mm dia.	<b>E32-DC33</b> 
			DA-HS	6 mm	_____	
			DA-LD	21 mm	_____	
			DA-SM	16 mm	0.01 mm dia.	
			F	1.8 mm	0.03 mm dia.	
			H	10 mm	0.015 mm dia.	
			NH	10 mm	0.012 mm dia.	
			NHB	NA	NA	
			NM	6 mm	0.015 mm dia.	
			NT	7 mm	0.012 mm dia.	
			NV	7 mm	0.012 mm dia.	
			NVG	NA	NA	
			VG	NA	NA	
Thin probe	Probe for space-confined sensing areas; 25 mm bending radius; 1 mm ID fiber	 M6 threaded head 90 mm (3.54 in) probe length 2 m (6.56 ft) length	A	75 mm	0.03 mm dia.	<b>E32-DC200B</b> 
			DA-HS	100 mm	_____	
			DA-LD	400 mm	_____	
			DA-SM	300 mm	0.01 mm dia.	
			F	33 mm	0.03 mm dia.	
			H	150 mm	0.015 mm dia.	
			NH	150 mm	0.012 mm dia.	
			NHB	20 mm	0.012 mm dia.	
			NM	100 mm	0.015 mm dia.	
			NT	110 mm	0.012 mm dia.	
			NV	110 mm	0.012 mm dia.	
			NVG	10 mm	1.0 mm dia.	
			VG	10 mm	1.0 mm dia.	

Note: Sensing distance is based on sensing a white paper that has 90% reflectivity.



## ■ DIFFUSE, PROBE TYPE (CONT.)

The table specifies the sensing characteristics of each fiber when used with the following amplifiers:

### Legend:

A . . . . . E3X-A (General purpose amplifier)

DA-HS . E3X-DA (Digital amplifier– high speed mode)

DA-LD . E3X-DA (Digital amplifier– long distance mode)

DA-SM . E3X-DA (Digital amplifier– standard distance mode)

F . . . . . E3X-F (High performance amplifier– high speed)

H . . . . . E3X-H11 (High gain amplifier)

NM . . . . E3X-NM (4 channel auto-tuning amplifier)

NT . . . . E3X-NT (Auto-tuning amplifier: general purpose)





NH . . . . E3X-NH (High-precision, auto-tuning amplifier)

NHB . . . E3X-NHB (High-precision, blue LED, auto-tuning amp)

NV . . . . E3X-NV21 (Water-resistant, red light source amplifier)

NVG . . . E3X-NVG21 (Water-resistant, green light source amp)

VG . . . . E3X-VG (Mark sensing amplifier)

Application	Features	Appearance	Type	Detection distance (see note)	Min. detectable object (gold wire)	Part number
Thin probe	Probe for space- confined sensing areas; 25 mm bending radius; 1 mm ID fiber	 M6 threaded head 40 mm (1.57 in) probe length  2 m (6.56 ft) length	A	75 mm	0.03 mm dia.	<b>E32-DC200B4</b> 
			DA-HS	100 mm	_____	
			DA-LD	400 mm	_____	
			DA-SM	300 mm	0.01 mm dia.	
			F	33 mm	0.03 mm dia.	
			H	150 mm	0.015 mm dia.	
			NH	150 mm	0.012 mm dia.	
			NHB	Contact Omron	Contact Omron	
			NM	100 mm	0.015 mm dia.	
			NT	110 mm	0.012 mm dia.	
			NV	110 mm	0.012 mm dia.	
			NVG	10 mm	1.0 mm dia.	
VG	10 mm	1.0 mm dia.				
Thin probe	Sensing head with 90 mm probe; spiral coiled cable with— stands repeated stretching from reciprocating machine parts; 25 mm bending radius; 1 mm ID fiber	 M6 threaded head 90 mm (3.54 in) probe length  Coiled 64 cm (2.1 ft) L; 2 m (6.56 ft) extended	A	22 mm	0.03 mm dia.	<b>E32-DC200D</b> 
			DA-HS	Contact Omron	Contact Omron	
			DA-LD	Contact Omron	Contact Omron	
			DA-SM	Contact Omron	Contact Omron	
			F	10 mm	0.03 mm dia.	
			H	44 mm	0.015 mm dia.	
			NH	44 mm	0.012 mm dia.	
			NHB	Contact Omron	Contact Omron	
			NM	Contact Omron	Contact Omron	
			NT	Contact Omron	Contact Omron	
			NV	Contact Omron	Contact Omron	
			NVG	Contact Omron	Contact Omron	
VG	2.5 mm	1.0 mm dia.				

Note: Sensing distance is based on sensing a white paper that has 90% reflectivity.

## ■ DIFFUSE, PROBE TYPE (CONT.)

The table specifies the sensing characteristics of each fiber when used with the following amplifiers:

### Legend:

A . . . . . E3X-A (General purpose amplifier)

DA-HS . E3X-DA (Digital amplifier– high speed mode)

DA-LD . E3X-DA (Digital amplifier– long distance mode)

DA-SM . E3X-DA (Digital amplifier– standard distance mode)

F . . . . . E3X-F (High performance amplifier– high speed)

H . . . . . E3X-H11 (High gain amplifier)

NM . . . . E3X-NM (4 channel auto-tuning amplifier)

NT . . . . E3X-NT (Auto-tuning amplifier: general purpose)





NH . . . . E3X-NH (High-precision, auto-tuning amplifier)

NHB . . . E3X-NHB (High-precision, blue LED, auto-tuning amp)

NV . . . . E3X-NV21 (Water-resistant, red light source amplifier)

NVG . . . E3X-NVG21 (Water-resistant, green light source amp)

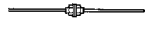
VG . . . . E3X-VG (Mark sensing amplifier)

Application	Features	Appearance	Type	Detection distance (see note)	Min. detectable object (gold wire)	Part number
Thin probe	Sensing head with 40 mm probe; spiral coiled cable with-stands repeated stretching from reciprocating machine parts; 25 mm bending radius; 1 mm ID fiber	 <p>M6 threaded head 40 mm (1.57 in) probe length</p> <p>Coiled 64 cm (2.1 ft) L; 2 m (6.56 ft) extended</p>	A	22 mm	0.03 mm dia.	<b>E32-DC200D4</b> 
			DA-HS	Contact Omron	Contact Omron	
			DA-LD	Contact Omron	Contact Omron	
			DA-SM	Contact Omron	Contact Omron	
			F	10 mm	0.03 mm dia.	
			H	44 mm	0.015 mm dia.	
			NH	44 mm	0.012 mm dia.	
			NHB	Contact Omron	Contact Omron	
			NM	Contact Omron	Contact Omron	
			NT	Contact Omron	Contact Omron	
			NV	Contact Omron	Contact Omron	
			NVG	Contact Omron	Contact Omron	
			VG	2.5 mm	1.0 mm dia.	
Thin probe	Sensing head with 90 mm probe; 25 mm bending radius; 0.5 mm ID fiber	 <p>M3 threaded head 90 mm (3.54 in) length probe</p> <p>2 m (6.56 ft) length</p>	A	18 mm	0.03 mm dia.	<b>E32-DC200F</b> 
			DA-HS	30 mm	—————	
			DA-LD	100 mm	—————	
			DA-SM	80 mm	0.01 mm dia.	
			F	8 mm	0.03 mm dia.	
			H	36 mm	0.015 mm dia.	
			NH	36 mm	0.012 mm dia.	
			NHB	Contact Omron	Contact Omron	
			NM	20 mm	0.015 mm dia.	
			NT	22 mm	0.012 mm dia.	
			NV	22 mm	0.012 mm dia.	
			NVG	2 mm	1.0 mm dia.	
			VG	2 mm	1.0 mm dia.	

Note: Sensing distance is based on sensing a white paper that has 90% reflectivity.

## ■ DIFFUSE, PROBE TYPE (CONT.)

### Legend:

A . . . . . E3X-A (General purpose amplifier)

DA-HS . E3X-DA (Digital amplifier– high speed mode)

DA-LD . E3X-DA (Digital amplifier– long distance mode)

DA-SM . E3X-DA (Digital amplifier– standard distance mode)

F . . . . . E3X-F (High performance amplifier– high speed)

H . . . . . E3X-H11 (High gain amplifier)

NM . . . . E3X-NM (4 channel auto-tuning amplifier)

NT . . . . E3X-NT (Auto-tuning amplifier: general purpose)





NH . . . . E3X-NH (High-precision, auto-tuning amplifier)

NHB . . . E3X-NHB (High-precision, blue LED, auto-tuning amp)

NV . . . . E3X-NV21 (Water-resistant, red light source amplifier)

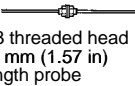
NVG . . . E3X-NVG21 (Water-resistant, green light source amp)

VG . . . . E3X-VG (Mark sensing amplifier)

Application	Features	Appearance	Type	Detection distance (see note)	Min. detectable object (gold wire)	Part number
Thin probe	Sensing head with 40 mm probe; 25 mm bending radius; 0.5 mm ID fiber	 <p>M3 threaded head 40 mm (1.57 in) length probe</p> <p>2 m (6.56 ft) length</p>	A	18 mm	0.03 mm dia.	<b>E32-DC200F4</b> 
			DA-HS	30 mm	_____	
			DA-LD	100 mm	_____	
			DA-SM	80 mm	0.01 mm dia.	
			F	8 mm	0.03 mm dia.	
			H	36 mm	0.015 mm dia.	
			NH	36 mm	0.012 mm dia.	
			NHB	Contact Omron	Contact Omron	
			NM	20 mm	0.015 mm dia.	
			NT	22 mm	0.012 mm dia.	
			NV	22 mm	0.012 mm dia.	
			NVG	2 mm	1.0 mm dia.	
VG	2 mm	1.0 mm dia.				
Thin probe	90 mm length probe mounts directly to amplifier; stainless steel probe; 1 mm ID fiber with 25 mm bending radius	 <p>1.2 mm dia.</p>	A	30 mm	0.03 mm dia.	<b>E32-DC9G</b>
			DA-HS	Contact Omron	Contact Omron	
			DA-LD	Contact Omron	Contact Omron	
			DA-SM	Contact Omron	Contact Omron	
			F	9 mm	0.03 mm dia.	
			H	60 mm	0.015 mm dia.	
			NH	60 mm	0.012 mm dia.	
			NHB	Contact Omron	Contact Omron	
			NM	Contact Omron	Contact Omron	
			NT	Contact Omron	Contact Omron	
			NV	Contact Omron	Contact Omron	
			NVG	Contact Omron	Contact Omron	
VG	2.5 mm	1.0 mm dia.				
Thin probe	40 mm length probe mounts directly to amplifier; stainless steel probe; 1 mm ID fiber with 25 mm bending radius	 <p>1.2 mm dia.</p>	A	30 mm	0.03 mm dia.	<b>E32-DC9G4</b>
			DA-HS	Contact Omron	Contact Omron	
			DA-LD	Contact Omron	Contact Omron	
			DA-SM	Contact Omron	Contact Omron	
			F	9 mm	0.03 mm dia.	
			H	60 mm	0.015 mm dia.	
			NH	60 mm	0.012 mm dia.	
			NHB	Contact Omron	Contact Omron	
			NM	Contact Omron	Contact Omron	
			NT	Contact Omron	Contact Omron	
			NV	Contact Omron	Contact Omron	
			NVG	Contact Omron	Contact Omron	
VG	2.5 mm	1.0 mm dia.				

Note: Sensing distance is based on sensing a white paper that has 90% reflectivity.

## ■ DIFFUSE, SIDE BEAM TYPE

The table specifies the sensing characteristics of each fiber when used with the following amplifiers:

### Legend:

A . . . . . E3X-A (General purpose amplifier)

DA-HS . E3X-DA (Digital amplifier– high speed mode)

DA-LD . E3X-DA (Digital amplifier– long distance mode)

DA-SM . E3X-DA (Digital amplifier– standard distance mode)

F . . . . . E3X-F (High performance amplifier– high speed)

H . . . . . E3X-H11 (High gain amplifier)

NM . . . . E3X-NM (4 channel auto-tuning amplifier)

NT . . . . E3X-NT (Auto-tuning amplifier: general purpose)





NH . . . . E3X-NH (High-precision, auto-tuning amplifier)

NHB . . . E3X-NHB (High-precision, blue LED, auto-tuning amp)

NV . . . . E3X-NV21 (Water-resistant, red light source amplifier)

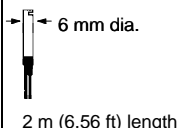
NVG . . . E3X-NVG21 (Water-resistant, green light source amp)

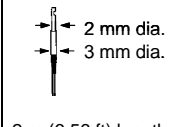
VG . . . . E3X-VG (Mark sensing amplifier)

Application	Features	Appearance	Type	Detection distance (see note)	Min. detectable object (gold wire)	Part number
Long distance; side view sensing	Space-saving, side view probe for long sensing distances; 1 mm ID fiber; 25 mm bending radius	 6 mm dia.  2 m (6.56 ft) length	A	40 mm	0.03 mm dia.	<b>E32-D14L</b> 
			DA-HS	50 mm	—————	
			DA-LD	150 mm	—————	
			DA-SM	110 mm	0.01 mm dia.	
			F	12 mm	0.5 mm dia.	
			H	40 mm	0.03 mm dia.	
			NH	40 mm	0.015 mm dia.	
			NHB	Contact Omron	Contact Omron	
			NM	40 mm	0.03 mm dia.	
			NT	44 mm	0.015 mm dia.	
			NV	44 mm	0.015 mm dia.	
			NVG	1.5 mm	1.0 mm dia.	
			VG	1.5 mm	1.0 mm dia.	
Small object	Side view; space saving thin fiber; 0.5 mm ID fiber; 25 mm bending radius	 2 mm dia. 3 mm dia.  2 m (6.56 ft) length	A	15 mm	0.03 mm dia.	<b>E32-D24</b> 
			DA-HS	10 mm	—————	
			DA-LD	40 mm	—————	
			DA-SM	30 mm	0.01 mm dia.	
			F	4 mm	0.03 mm dia.	
			H	15 mm	0.03 mm dia.	
			NH	15 mm	0.012 mm dia.	
			NHB	Contact Omron	Contact Omron	
			NM	15 mm	0.03 mm dia.	
			NT	17 mm	0.012 mm dia.	
			NV	17 mm	0.012 mm dia.	
			NVG	1.6 mm	1.0 mm dia.	
			VG	1.6 mm	1.0 mm dia.	

Note: Sensing distance is based on sensing a white paper that has 90% reflectivity.

## ■ DIFFUSE, HIGH TEMPERATURE TYPE

### Legend:

A . . . . . E3X-A (General purpose amplifier)

DA-HS . E3X-DA (Digital amplifier– high speed mode)

DA-LD . E3X-DA (Digital amplifier– long distance mode)

DA-SM . E3X-DA (Digital amplifier– standard distance mode)

F . . . . . E3X-F (High performance amplifier– high speed)

H . . . . . E3X-H11 (High gain amplifier)

NM . . . . E3X-NM (4 channel auto-tuning amplifier)

NT . . . . E3X-NT (Auto-tuning amplifier: general purpose)





NH . . . . E3X-NH (High-precision, auto-tuning amplifier)

NHB . . . E3X-NHB (High-precision, blue LED, auto-tuning amp)

NV . . . . E3X-NV21 (Water-resistant, red light source amplifier)

NVG . . . E3X-NVG21 (Water-resistant, green light source amp)

VG . . . . E3X-VG (Mark sensing amplifier)

Application	Features	Appearance	Type	Detection distance (see note)	Min. detectable object (gold wire)	Part number
Heat resistant	Resists 150°C; fiber sheath material: fluo- roresin. Operating ambient temperature: –40°C to 150°C (–40°F to 302°F); 1.5 mm ID fiber; 35 mm bending radius	 M6 threaded head 2 m (6.56 ft) length	A	60 mm	0.03 mm dia.	<b>E32-D51</b> 
			DA-HS	100 mm	_____	
			DA-LD	300 mm	_____	
			DA-SM	230 mm	0.01 mm dia.	
			F	26 mm	0.03 mm dia.	
			H	120 mm	0.03 mm dia.	
			NH	120 mm	0.012 mm dia.	
			NHB	12 mm	0.012 mm dia.	
			NM	60 mm	0.03 mm dia.	
			NT	65 mm	0.012 mm dia.	
			NV	65 mm	0.012 mm dia.	
			NVG	5 mm	1.0 mm dia.	
VG	5 mm	1.0 mm dia.				
Heat resistant	Resists 300°C, with spiral tube; high mechanical strength; fiber sheath material: stainless steel. Operating ambient temperature: –40°C to 300°C (–40°F to 572°F); 1.4 mm ID fiber; 25 mm bending radius	 M6 threaded head 2 m (6.56 ft) length	A	45 mm	0.03 mm dia.	<b>E32-D61</b>
			DA-HS	30 mm	_____	
			DA-LD	120 mm	_____	
			DA-SM	90 mm	0.01 mm dia.	
			F	20 mm	0.03 mm dia.	
			H	45 mm	0.03 mm dia.	
			NH	45 mm	0.012 mm dia.	
			NHB	Contact Omron	Contact Omron	
			NM	45 mm	0.03 mm dia.	
			NT	50 mm	0.012 mm dia.	
			NV	50 mm	0.012 mm dia.	
			NVG	5 mm	1.0 mm dia.	
VG	5 mm	1.0 mm dia.				
Heat resistant	High temperature glass core fiber with probe. Resists 400°C, with spiral tube; high mechani- cal strength; fiber sheath material: stainless steel. Operating ambient temperature: –40°C to 400°C (–40°F to 752°F); 1 mm ID fiber; 25 mm bending radius	 1.25 mm dia. M4 threaded head 2 m (6.56 ft) length	A	30 mm	0.03 mm dia.	<b>E32-D73</b>
			DA-HS	20 mm	_____	
			DA-LD	80 mm	_____	
			DA-SM	60 mm	0.01 mm dia.	
			F	17 mm	0.2 mm dia.	
			H	30 mm	0.03 mm dia.	
			NH	30 mm	0.012 mm dia.	
			NHB	Contact Omron	Contact Omron	
			NM	30 mm	0.03 mm dia.	
			NT	33 mm	0.012 mm dia.	
			NV	33 mm	0.012 mm dia.	
			NVG	3 mm	1.0 mm dia.	
VG	3 mm	1.0 mm dia.				

Note: Sensing distance is based on sensing a white paper that has 90% reflectivity.

## ■ DIFFUSE, CONVERGENT AND SPECIAL PURPOSE TYPES

The table specifies the sensing characteristics of each fiber when used with the following amplifiers:

### Legend:

A . . . . . E3X-A (General purpose amplifier)

DA-HS . E3X-DA (Digital amplifier– high speed mode)

DA-LD . E3X-DA (Digital amplifier– long distance mode)

DA-SM . E3X-DA (Digital amplifier– standard distance mode)

F . . . . . E3X-F (High performance amplifier– high speed)

H . . . . . E3X-H11 (High gain amplifier)

NM . . . . E3X-NM (4 channel auto-tuning amplifier)

NT . . . . E3X-NT (Auto-tuning amplifier: general purpose)





NH . . . . E3X-NH (High-precision, auto-tuning amplifier)

NHB . . . E3X-NHB (High-precision, blue LED, auto-tuning amp)

NV . . . . E3X-NV21 (Water-resistant, red light source amplifier)

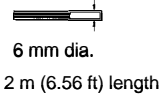
NVG . . . E3X-NVG21 (Water-resistant, green light source amp)

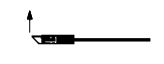
VG . . . . E3X-VG (Mark sensing amplifier)

Application	Features	Appearance	Type	Detection distance (see note)	Min. detectable object (gold wire)	Part number
Chemical resistant	Teflon coated sensing head for harsh chemical environments. Operating ambient temperature: –30°C to 70°C (–22°F to 158°F); 40 mm bending radius; 1 mm ID fiber	 6 mm dia. 2 m (6.56 ft) length	A	50 mm	0.03 mm dia.	<b>E32-D12F</b> 
			DA-HS	45 mm	_____	
			DA-LD	120 mm	_____	
			DA-SM	95 mm	0.01 mm dia.	
			F	20 mm	0.5 mm dia.	
			H	50 mm	0.03 mm dia.	
			NH	50 mm	0.012 mm dia.	
			NHB	10 mm	0.012 mm dia.	
			NM	50 mm	0.03 mm dia.	
			NT	55 mm	0.012 mm dia.	
			NV	55 mm	0.012 mm dia.	
			NVG	4 mm	0.5 mm dia.	
			VG	4 mm	0.5 mm dia.	
Wafer detection, height differences	Convergent beam suppresses background objects; long distance, side view. Operating ambient temperature: –40°C to 105°C (–40°F to 221°F); 10 mm bending radius	 2 m (6.56 ft) length	A	4 ± 2 mm	0.015 mm dia.	<b>E32-L24L</b> 
			DA-HS	4 ± 2 mm	_____	
			DA-LD	4 ± 2 mm	_____	
			DA-SM	4 ± 2 mm	0.01 mm dia.	
			F	4 ± 2 mm	0.015 mm dia.	
			H	4 ± 2 mm	Contact Omron	
			NH	4 ± 2 mm	0.012 mm dia.	
			NHB	NA	NA	
			NM	4 ± 2 mm	0.015 mm dia.	
			NT	4 ± 2 mm	0.012 mm dia.	
			NV	4 ± 2 mm	0.012 mm dia.	
			NVG	NA	NA	
			VG	NA	NA	

Note: Sensing distance is based on sensing a white paper that has 90% reflectivity.

## ■ DIFFUSE, CONVERGENT TYPES (CONT.)

### Legend:

A . . . . . E3X-A (General purpose amplifier)

DA-HS . E3X-DA (Digital amplifier– high speed mode)

DA-LD . E3X-DA (Digital amplifier– long distance mode)

DA-SM . E3X-DA (Digital amplifier– standard distance mode)

F . . . . . E3X-F (High performance amplifier– high speed)

H . . . . . E3X-H11 (High gain amplifier)

NM . . . . E3X-NM (4 channel auto-tuning amplifier)

NT . . . . E3X-NT (Auto-tuning amplifier: general purpose)







NH . . . . E3X-NH (High-precision, auto-tuning amplifier)

NHB . . . E3X-NHB (High-precision, blue LED, auto-tuning amp)

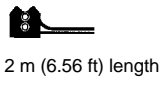
NV . . . . E3X-NV21 (Water-resistant, red light source amplifier)

NVG . . . E3X-NVG21 (Water-resistant, green light source amp)

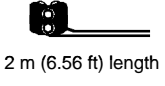
VG . . . . E3X-VG (Mark sensing amplifier)

Application	Features	Appearance	Type	Detection distance (see note)	Min. detectable object (gold wire)	Part number
Wafer detection, height differences	Convergent beam suppresses back- ground objects; cable exits the side; 25 mm bending radius	 2 m (6.56 ft) length	A	3.3 mm	0.03 mm dia.	<b>E32-L25</b> 
			DA-HS	3.3 mm	_____	
			DA-LD	3.3 mm	_____	
			DA-SM	3.3 mm	0.01 mm dia.	
			F	3.3 mm	0.5 mm dia.	
			H	3.3 mm	0.015 mm dia.	
			NH	3.3 mm	0.012 mm dia.	
			NHB	NA	NA	
			NM	3.3 mm	0.015 mm dia.	
			NT	3.3 mm	0.012 mm dia.	
			NV	3.3 mm	0.012 mm dia.	
			NVG	NA	NA	
			VG	NA	NA	
Wafer detection, height differences	Convergent beam suppresses back- ground objects; cable exits the bottom; 25 mm bending radius	 2 m (6.56 ft) length	A	3.3 mm	0.03 mm dia.	<b>E32-L25A</b> 
			DA-HS	3.3 mm	_____	
			DA-LD	3.3 mm	_____	
			DA-SM	3.3 mm	0.01 mm dia.	
			F	3.3 mm	0.5 mm dia.	
			H	3.3 mm	0.015 mm dia.	
			NH	3.3 mm	0.012 mm dia.	
			NHB	NA	NA	
			NM	3.3 mm	0.015 mm dia.	
			NT	3.3 mm	0.012 mm dia.	
			NV	3.3 mm	0.012 mm dia.	
			NVG	NA	NA	
			VG	NA	NA	
Wafer detection, height differences	Long distance con- vergent beam type suppresses back- ground objects; cable exits the side; 10 mm bending radius	 2 m (6.56 ft) length	A	7.2 ± 1.8 mm	0.015 mm dia.	<b>E32-L25L</b> 
			DA-HS	7.2 ± 1.8 mm	_____	
			DA-LD	7.2 ± 1.8 mm	_____	
			DA-SM	7.2 ± 1.8 mm	0.01 mm dia.	
			F	7.2 ± 1.8 mm	0.015 mm dia.	
			H	7.2 ± 1.8 mm	0.015 mm dia.	
			NH	7.2 ± 1.8 mm	0.012 mm dia.	
			NHB	NA	NA	
			NM	7.2 ± 1.8 mm	0.015 mm dia.	
			NT	7.2 ± 1.8 mm	0.012 mm dia.	
			NV	7.2 ± 1.8 mm	0.012 mm dia.	
			NVG	NA	NA	
			VG	NA	NA	

Note: Sensing distance is based on sensing a white paper that has 90% reflectivity.

## ■ RETROREFLECTIVE TYPE

The table specifies the sensing characteristics of each fiber when used with the following amplifiers:

### Legend:

A . . . . . E3X-A (General purpose amplifier)

DA-HS . E3X-DA (Digital amplifier– high speed mode)

DA-LD . E3X-DA (Digital amplifier– long distance mode)

DA-SM . E3X-DA (Digital amplifier– standard distance mode)

F . . . . . E3X-F (High performance amplifier– high speed)

H . . . . . E3X-H11 (High gain amplifier)

NM . . . . E3X-NM (4 channel auto-tuning amplifier)

NT . . . . E3X-NT (Auto-tuning amplifier: general purpose)





NH . . . . E3X-NH (High-precision, auto-tuning amplifier)

NHB . . . E3X-NHB (High-precision, blue LED, auto-tuning amp)

NV . . . . E3X-NV21 (Water-resistant, red light source amplifier)

NVG . . . E3X-NVG21 (Water-resistant, green light source amp)

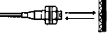
VG . . . . E3X-VG (Mark sensing amplifier)

Application	Features	Appearance	Type	Detection distance (see note)	Min. detectable object (gold wire)	Part number
Detects shiny, transparent and opaque objects	Block style sensing head detects objects over a long range; 25 mm bending radius	 Reflector E39-R1  2 m (6.56 ft) length	A	150 to 1,500 mm	0.6 mm dia.	<b>E32-R16 + E39-R1</b> 
			DA-HS	150 to 1,500 mm	_____	
			DA-LD	150 to 1,500 mm	_____	
			DA-SM	150 to 1,500 mm	0.2 mm dia.	
			F	50 to 700 mm	0.6 mm dia.	
			H	150 to 1,500 mm	0.6 mm dia.	
			NH	150 to 1,500 mm	0.5 mm dia.	
			NHB	NA	NA	
			NM	150 to 1,500 mm	1.9 mm dia.	
			NT	150 to 1,500 mm	0.5 mm dia.	
			NV	150 to 1,500 mm	0.5 mm dia.	
			NVG	NA	NA	
			VG	NA	NA	
Detect transparent objects	Compact threaded sensing head is easy to install; 25 mm bending radius.	 M6 threaded head Reflector E39-R3  2 m (6.56 ft) length	A	10 to 250 mm	0.3 mm dia.	<b>E32-R21 + E39-R3</b> 
			DA-HS	10 to 250 mm	_____	
			DA-LD	10 to 250 mm	_____	
			DA-SM	10 to 250 mm	0.1 mm dia.	
			F	20 to 230 mm	0.5 mm dia.	
			H	10 to 250 mm	0.3 mm dia.	
			NH	10 to 250 mm	0.3 mm dia.	
			NHB	NA	NA	
			NM	25 to 250 mm	0.6 mm dia.	
			NT	25 to 250 mm	0.3 mm dia.	
			NV	25 to 250 mm	0.3 mm dia.	
			NVG	NA	NA	
			VG	NA	NA	









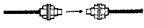

## ■ BLOCK STYLE FIBER-OPTIC AMPLIFIERS

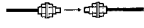
The following tables show the detection distance for selected fiber-optic cables in combination with Omron block style amplifiers. These amplifiers offer specialized capabilities to solve particular application problems.

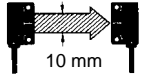







### ■ E3MC-(M)Y RGB COLOR SENSOR

#### Through-beam Fiber-optic Cables

Application	Features	Appearance	Detection distance (see note)	Part number
General purpose	Compact threaded head; 25 mm bending radius; 1 mm ID fiber	 M4 threaded head x 14 mm (0.55 in) L 2 m (6.56 ft) length	30 mm	E32-TC200 
Long distance	Compact M4, head, 1. mm ID fiber; 25 mm bending radius; 1.4 mm ID fiber	 M4 threaded head x 11 mm (0.43 in) L 2 m (6.56 ft) length	60 mm	E32-T11L 
Area sensing	10 mm wide beam, long sensing distance; 25 mm bending radius; 1 mm ID fiber	 2 m (6.56 ft) length	200 mm	E32-T16 
Long distance	M14 with magnifying lens extends sensing distance; ideal for explosion-proof applications; 25 mm bending radius; 1 mm ID fiber	 M14 threaded head x 23 mm (0.91 in) L 10 m (32.8 ft) length	1,100 mm	E32-T17L 

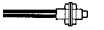
Note: The E3MC-(M)Y discriminates red, blue, and yellow films at the above distances.











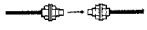

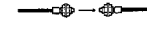

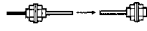

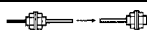

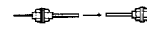

#### Diffuse Fiber-optic Cables

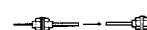
Application	Features	Appearance	Detection distance (see note)	Part number
High precision positioning	Concentric beam: emitter in the center and a ring of 16 receivers in the 2.5 mm dia. tip; 25 mm bending radius; 1 mm ID fiber; coaxial diffuse	 M6 threaded head x 20 mm (0.79 in) L 2 m (6.56 ft) length	5 mm	E32-CC200 
General purpose	Compact threaded head; 25 mm bending radius; 1 mm ID fiber	 M6 threaded head x 14 mm (0.55 in) L 2 m (6.56 ft) length	5 mm	E32-DC200 
Long distance	Compact threaded sensing head; 25 mm bending radius; 1 mm ID fiber	 M6 threaded head x 17 mm (0.67 in) L 2 m (6.56 ft) length	5 mm	E32-D11L 
Precise positioning	Concentric beam: light source in the center with a ring of 16 receivers in 3 mm dia. tip; 25 mm bending radius; coaxial diffuse	 3 mm (0.12 in) dia. x 15 mm (0.59 in) L 2 m (6.56 ft) length	4.5 mm	E32-D32L 

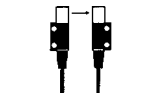
Note: The E3MC-(M)Y discriminates eleven colors at the above distances. For a typical example, nine colors are discriminated at a sensing distance of 12 mm.

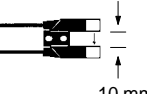

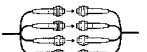
## ■ E3XA-CC4A ANALOG FIBER-OPTIC AMPLIFIER

### Through-beam Fiber-optic Cables





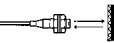







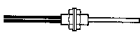

Application	Features	Appearance	Detection distance	Min. detectable object	Part number
General purpose	Compact threaded head; 25 mm bending radius; 1 mm ID fiber	 M4 threaded head x 14 mm (0.55 in) L 2 m (6.56 ft) length	80 mm (600 mm*)	0.2 mm dia.	<b>E32-TC200</b> 
General purpose	M3; possible to mount the reflective side-view conversion attachment (E39-F5); 25 mm bending radius; 1 mm ID fiber	 M3 threaded head x 12.5 mm (0.49 in) L 2 m (6.56 ft) length	80 mm	0.2 mm dia.	<b>E32-TC200A</b> 
Thin probe	Probe for space-confined sensing areas; 25 mm bending radius; 1 mm ID fiber	 M4 threaded head 90 mm (3.54 in) probe length 2 m (6.56 ft) length	80 mm	0.2 mm dia.	<b>E32-TC200B</b> 
Thin probe	Probe for space-confined sensing areas; 25 mm bending radius; 1 mm ID fiber	 M4 threaded head 40 mm (1.57 in) probe length 2 m (6.56 ft) length	80 mm	0.2 mm dia.	<b>E32-TC200B4</b> 
General purpose	M3; suitable for detecting minute objects; 25 mm bending radius; 0.5 mm ID fiber	 M3 threaded head x 11 mm (0.43 in) L 2 m (6.56 ft) length	20 mm	0.1 mm dia.	<b>E32-TC200E</b> 
Bendable probe	Sensing head with 90 mm probe; 25 mm bending radius	 M3 threaded head 90 mm (3.54 in) length probe 2 m (6.56 ft) length	20 mm	0.1 mm dia.	<b>E32-TC200F</b> 
Bendable probe	Sensing head with 90 mm probe; 25 mm bending radius	 M3 threaded head 40 mm (1.57 in) length probe 2 m (6.56 ft) length	20 mm	0.1 mm dia.	<b>E32-TC200F4</b> 
Long distance	Built-in lens provides long sensing distance; each sensing head has two 3.2 mm screw mounting holes; 25 mm bending radius; 1 mm ID fiber	 2 m (6.56 ft) length	90 mm	0.8 mm dia.	<b>E32-T14</b> 
Mark/edge detection	Ideal for mark sensing or belt alignment; no optical axis adjustment required; easy to mount; 1 mm ID fiber	 10 mm 2 m (6.56 ft) length	10 mm	0.8 mm dia.	<b>E32-G14</b> 
Area sensing	Multiple heads allow shape recognition; 0.5 mm ID fiber	 M3 threaded head x 11 mm (0.43 in) L 2 m (6.56 ft) length	100 mm	0.3 mm dia.	<b>E32-M21</b> 

Note: \*Value in parentheses represents the sensing distance of the fiber when the E39-F1 lens is attached to its tip.

## Retroreflective Fiber-optic Cables with E3XA-CC4A Amplifier

Application	Features	Appearance	Detection distance	Min. detectable object	Part number
Detect transparent and shiny objects	Compact threaded sensing head is easy to install.	 <p>M6 threaded head Reflector E39-R3 2 m (6.56 ft) length</p>	30 to 200 mm	0.3 mm dia.	<b>E32-R21 + E39-R3</b> 

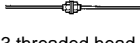
## Diffuse Fiber-optic Cables with E3XA-CC4A Amplifier

Application	Features	Appearance	Detection distance	Min. detectable object	Part number
General purpose	Compact threaded head; 25 mm bending radius; 1 mm ID fiber	 <p>M6 threaded head x 14 mm (0.55 in) L 2 m (6.56 ft) length</p>	30 mm	0.03 mm dia.	<b>E32-DC200</b> 
General purpose	M3; possible to mount the reflective side-view conversion attachment (E39-F5); 25 mm bending radius; 1 mm ID fiber	 <p>M6 threaded head x 20 mm (0.79 in) L 2 m (6.56 ft) length</p>	30 mm	0.03 mm dia.	<b>E32-CC200</b> 
Thin probe	Probe for space-confined sensing areas; 25 mm bending radius; 1 mm ID fiber	 <p>M6 threaded head 90 mm (3.54 in) probe length 2 m (6.56 ft) length</p>	30 mm	0.03 mm dia.	<b>E32-DC200B</b> 
Thin probe	Probe for space-confined sensing areas; 25 mm bending radius; 1 mm ID fiber	 <p>M6 threaded head 40 mm (1.57 in) probe length 2 m (6.56 ft) length</p>	30 mm	0.03 mm dia.	<b>E32-DC200B4</b> 
General purpose	M3; suitable for detecting minute objects; 25 mm bending radius; 0.5 mm ID fiber	 <p>M3 threaded head x 11 mm (0.43 in) L 2 m (6.56 ft) length</p>	7 mm	0.03 mm dia.	<b>E32-DC200E</b> 
Thin probe	Sensing head with 90 mm probe; 25 mm bending radius; 0.5 mm ID fiber	 <p>M3 threaded head 90 mm (3.54 in) length probe 2 m (6.56 ft) length</p>	7 mm	0.03 mm dia.	<b>E32-DC200F</b> 
Thin probe	Sensing head with 40 mm probe; 25 mm bending radius; 0.5 mm ID fiber	 <p>M3 threaded head 40 mm (1.57 in) length probe 2 m (6.56 ft) length</p>	7 mm	0.03 mm dia.	<b>E32-DC200F4</b> 

## ■ E3JU-X LIMIT SWITCH STYLE (IR LED)

### Armored Through-beam Fiber-optic Cables

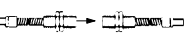
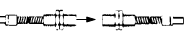



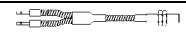



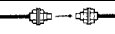

Application	Features	Appearance	Detection distance	Min. detectable object	Part number
General purpose	Can withstand temperatures to 200°C (392°F)	 5/16–24 thread x 38.1 mm (1.5 in) L 0.91 m (3 ft) length	400 mm	0.25 mm dia.	<b>E32-UTBT1-3F</b>
General purpose	Can withstand temperatures to 200°C (392°F)	 5/16–24 thread x 38.1 mm (1.5 in) L 1.83 m (6 ft) length	400 mm	0.25 mm dia.	<b>E32-UTBT1-6F</b>

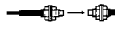
### Armored Diffuse Fiber-optic Cables

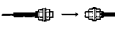

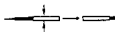

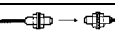

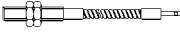



Application	Features	Appearance	Detection distance	Min. detectable object (gold wire)	Part number
General purpose	Can withstand temperatures to 200°C (392°F)	 5/16–24 thread x 38.1 mm (1.5 in) L 0.91 m (3 ft) length	90 mm	0.05 mm dia.	<b>E32-UDBT1-3F</b>
General purpose	Can withstand temperatures to 200°C (392°F)	 5/16–24 thread x 38.1 mm (1.5 in) L 1.83 m (6 ft) length	80 mm	0.05 mm dia.	<b>E32-UDBT1-6F</b>

## ■ E3JU-XR LIMIT SWITCH STYLE (RED LED)

### Through-beam Fiber-optic Cables

Application	Features	Appearance	Detection distance	Min. detectable object	Part number
General purpose	Compact threaded head; 25 mm bending radius; 1 mm ID fiber	 M4 threaded head x 14 mm (0.55 in) L  2 m (6.56 ft) length	200 mm	0.2 mm dia.	<b>E32-TC200</b> 
Flexible, resists breaking	Ideal for mounting on moving section; 4 mm bending radius; 1.5 mm ID fiber	 M4 threaded head x 11.7 mm (0.46 in) L  2 m (6.56 ft) length	135 mm	0.5 mm dia.	<b>E32-T11</b> 
	Compact M3 head ideal for mounting on moving sections; 4 mm bending radius; 0.5 mm ID fiber	 M3 threaded head x 11 mm (0.43 in) L  2 m (6.56 ft) length	39 mm	0.2 mm dia.	<b>E32-T21</b> 
Minute objects	2 mm dia. head fits in space- confined areas; 25 mm bending radius; 0.5 mm ID fiber	 2 mm dia. (0.8 in) x 22 mm (0.87 in)  2 m (6.56 ft) length	50 mm	0.2 mm dia.	<b>E32-T22</b> 
Heat resistant	Resists 150°C; fiber sheath material: fluororesin. Operating ambient temperature: -40°C to 150°C (-40°F to 302°F); 35 mm bending radius; 1.5 mm ID fiber	 M4 threaded head x 17 mm (0.67 in) L  2 m (6.56 ft) length	150 mm	1.0 mm dia.	<b>E32-T51</b> 
General purpose	Armored glass fiber-optic cable can withstand tempera- tures to 200°C (392°F)	 5/16-24 thread x 38.1 mm (1.5 in) L  0.91 m (3 ft) length	200 mm	0.2 mm dia.	<b>E32-UTAT1-3F</b>
General purpose	Armored glass fiber-optic cable can withstand tempera- tures to 200°C (392°F)	 5/16-24 thread x 38.1 mm (1.5 in) L  1.83 m (6 ft) length	170 mm	0.2 mm dia.	<b>E32-UTAT1-6F</b>

## Diffuse Fiber-optic Cables with E3JU-XR Amplifiers

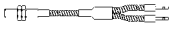
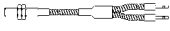









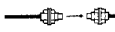

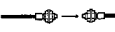

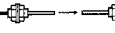
Application	Features	Appearance	Detection distance	Min. detectable object	Part number
General purpose	Compact threaded head; 25 mm bending radius; 1 mm ID fiber	 M6 threaded head x 14 mm (0.55 in) L 2 m (6.56 ft) length	75 mm	0.015 mm dia.	<b>E32-DC200</b> 
General purpose	Compact threaded head; 4 mm bending radius; 0.25 mm ID fiber	 M6 threaded head x 17 mm (0.67 in) L 2 m (6.56 ft) length	45 mm	0.03 mm dia.	<b>E32-D11</b> 
General purpose	Compact threaded head; 4 mm bending radius; 0.25 mm ID fiber	 M3 threaded head x 11 mm (0.43 in) L 2 m (6.56 ft) length	7 mm	0.03 mm dia.	<b>E32-D21</b> 
General purpose	Compact threaded head; 25 mm bending radius; 0.25 mm ID fiber; coaxial	 2 mm (0.08 in) dia. x 15 mm (0.59 in) tip; 29 mm (1.14 in) L overall 2 m (6.56 ft) length	18 mm	0.03 mm dia.	<b>E32-D32</b> 
Heat resistant	Resists 150°C; fiber sheath material: fluororesin. Operating ambient temperature: -40°C to 150°C (-40°F to 302°F); 35 mm bending radius; 1.5 mm ID fiber	 M6 threaded head 2 m (6.56 ft) length	60 mm	0.03 mm dia.	<b>E32-D51</b> 
General purpose	Armored glass fiber-optic cable can withstand temperatures to 150°C (302°F)	 5/16-24 thread x 38.1 mm (1.5 in) L 0.91 m (3 ft) length	80 mm	0.03 mm dia.	<b>E32-UDAT1-3F</b>
General purpose	Armored glass fiber-optic cable can withstand temperatures to 150°C (302°F)	 5/16-24 thread x 38.1 mm (1.5 in) L 1.83 m (6 ft) length	65 mm	0.03 mm dia.	<b>E32-UDAT1-6F</b>

## ■ E3A2-X AND E3S-X3 BLOCK STYLE AMPLIFIERS



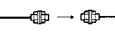

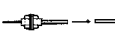







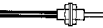

The table specifies the sensing characteristics of each fiber when used with the following amplifiers:

**A2X:** E3A2-X Slim Amplifier with Plug-in Output  
**SX3:** E3S-X3 Rugged Metal Body DC Amplifier

### Through-beam Fiber-optic Cables

Application	Features	Appearance	Type	Detection distance	Min. detectable object (opaque)	Part number
General purpose	Compact threaded head; 25 mm bending radius; 1 mm ID fiber	 M4 threaded head x 14 mm (0.55 in) L 2 m (6.56 ft) length	A2X	120 mm	1.0 mm dia.	<b>E32-TC200</b> 
			SX3			
General purpose	M3; possible to mount the reflective side view conversion attachment (E39-F5); 25 mm bending radius; 1 mm ID fiber	 M3 threaded head x 7 mm (0.28 in) L 2 m (6.56 ft) length	A2X	120 mm	1.0 mm dia.	<b>E32-TC200A</b> 
			SX3			
Thin probe	Probe for space-confined sensing areas; 25 mm bending radius; 1 mm ID fiber	 M4 threaded head 90 mm (3.54 in) probe length 2 m (6.56 ft) length	A2X	120 mm	1.0 mm dia.	<b>E32-TC200B</b> 
			SX3			
General purpose	Coiled cable ideal for moving parts; 25 mm bending radius; 1 mm ID fiber	 M4 threaded head x 11 mm (0.43 in) L 56.5 cm (1.85 ft) L; 2 m (6.56 ft) extended	A2X	100 mm	1.0 mm dia.	<b>E32-TC200C</b> 
			SX3			
Thin probe	Sensing head with 90 mm probe; spiral coiled cable withstands repeated stretching from reciprocating machine parts; 25 mm bending radius; 1 mm ID fiber	 M4 threaded head 90 mm (3.54 in) probe length 56.6 cm (1.85 ft); 2 m (6.56 ft) extended	A2X	100 mm	1.0 mm dia.	<b>E32-TC200D</b> 
			SX3			
General purpose	Thin fiber with small easy-to-mount head.; 25 mm bending radius; 0.5 mm ID fiber	 M3 threaded head x 11 mm (0.43 in) L 2 m (6.56 ft) length	A2X	35 mm	0.5 mm dia.	<b>E32-TC200E</b> 
			SX3			
Thin probe	Sensing head with 90 mm probe; 25 mm bending radius; 0.5 mm ID fiber	 M3 threaded head 90 mm (3.54 in) length probe 2 m (6.56 ft) length	A2X	35 mm	0.5 mm dia.	<b>E32-TC200F</b> 
			SX3			

## Diffuse Fiber-optic Cables for E3A2-X and E3S-X3 Amplifiers

Application	Features	Appearance	Type	Detection distance	Standard object (see note)	Part number
High accuracy positioning	Concentric beam: emitter in the center and a ring of 16 receivers in the 2.5 mm dia. tip; 25 mm bending radius; 1 mm ID fiber	 M6 threaded head x 20 mm (0.79 in) L 2 m (6.56 ft) length	A2X	50 mm	30 x 30 mm	E32-CC200 
			SX3			
General purpose	Compact threaded head; 25 mm bending radius; 1 mm ID fiber	 M6 threaded head x 14 mm (0.55 in) L 2 m (6.56 ft) length	A2X	50 mm	30 x 30 mm	E32-DC200 
			SX3			
Thin probe	Probe for space-confined sensing areas; 25 mm bending radius; 1 mm ID fiber	 M6 threaded head 90 mm (3.54 in) probe length 2 m (6.56 ft) length	A2X	50 mm	30 x 30 mm	E32-DC200B 
			SX3			
General purpose	Coiled cable ideal for moving parts; 25 mm bending radius; 1 mm ID fiber	 M6 threaded head x 17 mm (0.67 in) L 64 cm (2.1 ft) L coiled; 2 m (6.56 ft) extended.	A2X	15 mm	30 x 30 mm	E32-DC200C 
			SX3			
Thin probe	Sensing head with 90 mm probe; spiral coiled cable with-stands repeated stretching from reciprocating machine parts; 25 mm bending radius; 1 mm ID fiber	 M6 threaded head 90 mm (3.54 in) probe length 64 cm (2.1 ft) L coiled; 2 m (6.56 ft) extended	A2X	15 mm	30 x 30 mm	E32-DC200D 
			SX3			
General purpose	Thin fiber with small easy-to-mount head.; 25 mm bending radius; 0.5 mm ID fiber	 M3 threaded head x 11 mm (0.43 in) L 2 m (6.56 ft) length	A2X	12 mm	15 x 15 mm	E32-DC200E 
			SX3			
Thin probe	Sensing head with 90 mm probe; 25 mm bending radius; 0.5 mm ID fiber	 M3 threaded head 90 mm (3.54 in) length probe 2 m (6.56 ft) length	A2X	12 mm	15 x 15 mm	E32-DC200F 
			SX3			

Note: A standard object for the diffuse fiber-optic cables is a Kodak 90% reflectance white card.



# Specifications

## ■ THROUGH-BEAM FIBER-OPTIC CABLES

Part number	Operating ambient temperature	Operating relative humidity	Permissible bending radius	Core material	Sheath material	Enclosure rating	
E32-T11	-40°C to 70°C (-40°F to 158°F) with no icing	35% to 85% with no condensation	4 mm min.	PMMA	Vinyl chloride	IEC IP67	
E32-T11L			25 mm min.		Black polyethylene		
E32-T11R			1 mm min.		Copolymer vinyl chloride		
E32-T12L			25 mm min.		Black polyethylene		
E32-T17L			25 mm min.		Black polyethylene		
E32-T21			4 mm min.		Vinyl chloride		
E32-T21L			25 mm min.		Black polyethylene		
E32-T21R			1 mm min.		Copolymer vinyl chloride		
E32-T22			25 mm min.		Black polyethylene		
E32-T22L			25 mm min.		Black polyethylene		
E32-TC50 E32-TC200			25 mm min.		Black polyethylene		
E32-TC200A			25 mm min.		Black polyethylene		
E32-TC200C			25 mm min.		Black polyethylene		
E32-TC200E			25 mm min.		Black polyethylene		
E32-TC500 E32-TC1000			25 mm min.		Black polyethylene		
E32-UTAT1-3F E32-UTAT1-6F			-40°C to 150°C (-40°F to 302°F) with no icing				25 mm min.
E32-UTBT1-3F E32-UTBT1-6F	-40°C to 200°C (-40°F to 392°F) with no icing		25 mm min.	Glass	SUS 303 head, SUS 304 sheath		
E32-T33-1	-40°C to 70°C (-40°F to 158°F) with no icing		25 mm min.	PMMA	Black polyethylene, stainless steel head		
E32-TC200B E32-TC200B4			25 mm min.		Black polyethylene		
E32-TC200D E32-TC200D4			25 mm min.		Black polyethylene		
E32-TC200F E32-TC200F4			25 mm min.		Black polyethylene		
E32-T14			25 mm min.		Black polyethylene		
E32-T14L			25 mm min.		Black polyethylene		
E32-T16			25 mm min.		Black polyethylene		
E32-T16P			10 mm min.		Vinyl chloride		IEC IP50
E32-T24			25 mm min.		Black polyethylene		IEC IP67
E32-T51*			-40°C to 150°C (-40°F to 302°F) with no icing				35 mm min.
E32-T61	-40°C to 300°C (-40°F to 572°F) with no icing		25 mm min.	Glass	304 stainless steel		
E32-G14	-40°C to 70°C (-40°F to 158°F) with no icing		25 mm min.	PMMA	Black polyethylene		
E32-M21			25 mm min.		Black polyethylene		
E32-T12F	-30°C to 70°C (-22°F to 158°F) with no icing		40 mm min.		Teflon®-covered black polyethylene		

\*When used continuously between -40°C and 130°C (-40°F and 266°F)

Teflon is a registered trademark of the Dupont Company and the Mitsui Dupont Chemical Company for their fluoride resin.

## Through-beam Fiber-optic Cables Continued

Part number	Operating ambient temperature	Operating relative humidity	Permissible bending radius**	Core material	Sheath material	Enclosure rating
E32-T22S*	-40°C to 70°C (-40°F to 158°F) with no icing	35% to 85% with no condensation	10 mm min.	PMMA	Copolymer vinyl chloride	IEC IP67
E32-T24S*			25 mm min.	Glass		
E32-T84S*	-40°C to 200°C (-40°F to 392°F) with no icing					

\*13 mm dia. beam size at a distance of 200 mm

\*\*Average at 30% of sensing distance

## ■ DIFFUSE FIBER-OPTIC CABLES\*

Part number	Operating ambient temperature	Operating relative humidity	Permissible bending radius	Core material	Sheath material	Enclosure rating
E32-CC200	-40°C to 70°C (-40°F to 158°F) with no icing	35% to 85% with no condensation	25 mm min.	PMMA	Black polyethylene	IEC IP67
E32-D11			4 mm min.		Vinyl chloride	
E32-D11L			25 mm min.		Black polyethylene	
E32-D11R			1 mm min.		Copolymer vinyl chloride	
E32-D21			4 mm min.		Vinyl chloride	
E32-D21L			25 mm min.		Black polyethylene	
E32-D21R			1 mm min.		Black polyethylene	
E32-D22L			25 mm min.		Black polyethylene	
E32-D32						
E32-D32L						
E32-DC50, E32-DC200						
E32-DC200C						
E32-DC200E						
E32-DC500, E32-DC1000						
E32-UDAT1-3F, E32-UDAT1-6F	-40°C to 150°C (-40°F to 302°F) with no icing		25 mm min.	Glass	SUS 303 head, SUS 304 sheath	
E32-UDBT1-3F, E32-UDBT1-6F	-40°C to 200°C (-40°F to 392°F) with no icing		25 mm min.	Glass	SUS 303 head, SUS 304 sheath	
E32-D33	-40°C to 70°C (-40°F to 158°F) with no icing		25 mm min.	PMMA	Black polyethylene	
E32-DC200B, E32-DC200B4						
E32-DC200D, E32-DC200D4						
E32-DC200F, E32-DC200F4						
E32-DC9G, E32-DC9G4			12.5 mm min.		Stainless steel	
E32-D14L			25 mm min.		Black polyethylene	
E32-D24			25 mm min.		Black polyethylene	
E32-D51**			-40°C to 150°C (-40°F to 302°F) with no icing			35 mm min.

\*Differential travel is 20% of max. detection distance. With E3X-H11 amplifier, this is adjustable between 0% and 20%.

\*\*When used continuously between -40°C and 130°C (-40°F and 266°F)

**Diffuse Fiber-optic Cables Continued\***

Part number	Operating ambient temperature	Operating relative humidity	Permissible bending radius	Core material	Sheath material	Enclosure rating
E32-D61	-40°C to 300°C (-40°F to 572°F) with no icing	35% to 85% with no condensation	25 mm min.	Glass	304 stainless steel	IEC IP67
E32-D73	-40°C to 400°C (-40°F to 752°F) with no icing		25 mm min.	Glass	304 stainless steel	IEC IP67
E32-D12F	-30°C to 70°C (-22°F to 158°F) with no icing	35% to 85% with no condensation	40 mm min.	PMMA	Teflon <sup>®</sup> -covered black polyethylene	IEC IP67
E32-L24L**	-40°C to 105°C (-40°F to 221°F) with no icing		10 mm min. (average 10% decrease in sensing distance)	PMMA	Reinforced polyethylene	IEC IP50
E32-L25	-40°C to 70°C (-40°F to 158°F) with no icing		25 mm min.	PMMA	Black polyethylene	IEC IP50
E32-L25A			25 mm min.	PMMA	Black polyethylene	IEC IP50
E32-L25L**	-40°C to 105°C (-40°F to 221°F) with no icing		10 mm min. (average 10% decrease in sensing distance)	PMMA	Reinforced polyethylene	IEC IP50

\*Differential travel is 20% of max. detection distance. With E3X-H11 amplifier, this is adjustable between 0% and 20%.

\*\*Beam size is 2 mm dia.

Teflon is a registered trademark of the Dupont Company and the Mitsui Dupont Chemical Company for their fluoride resin.

**■ RETROREFLECTIVE FIBER-OPTIC CABLES**

Part number	Operating ambient temperature	Operating relative humidity	Permissible bending radius	Core material	Sheath material	Enclosure rating
E32-R16 with E39-R1 reflector	-25°C to 55°C (-13°F to 131°F) with no icing	35% to 85%	25 mm min.	PMMA	Black polyethylene	IEC IP66
E32-R21 with E39-R3 reflector	-40°C to 70°C (-40°F to 158°F) with no icing					IEC IP67

# Engineering Data

## EXCESS GAIN RATIO

Through-beam Type, General Purpose

E32-T11 with E3X-A11 amplifier

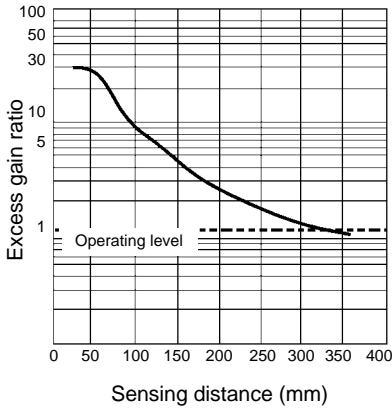

E32-T11 with E3JU-XR amplifier

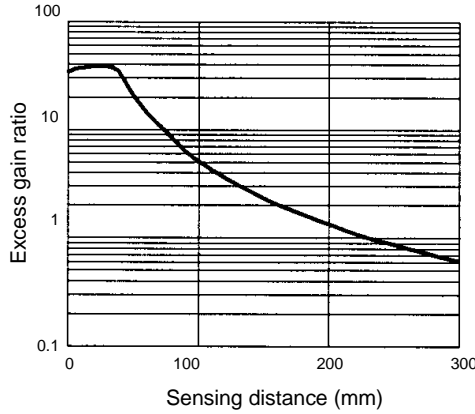

E32-T11L with E3X-A, E3X-F and E3X-VG amplifiers

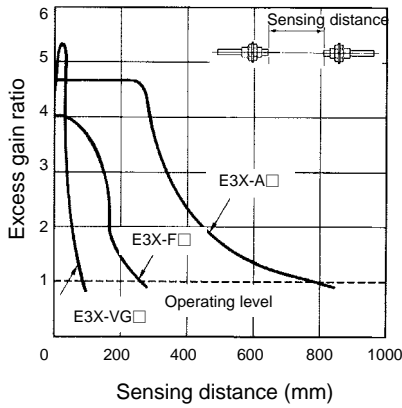

E32-T11L with E3X-H11 amplifier

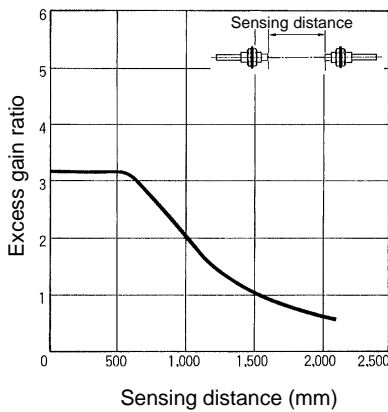

E32-T11L + E39-F1 with E3X-H11 amplifier

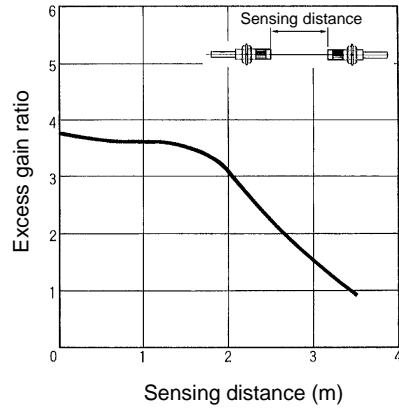

E32-T11L with E39-F2 and E3X-H11 amplifier

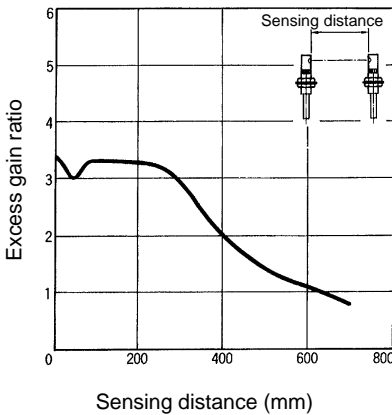

E32-T11L with E39-F3 and E3X-H11 amplifier

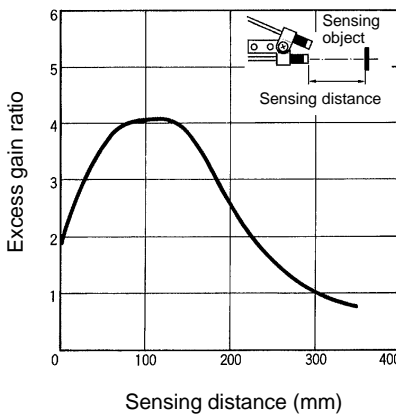

E32-T11L with E3X-NH amplifier

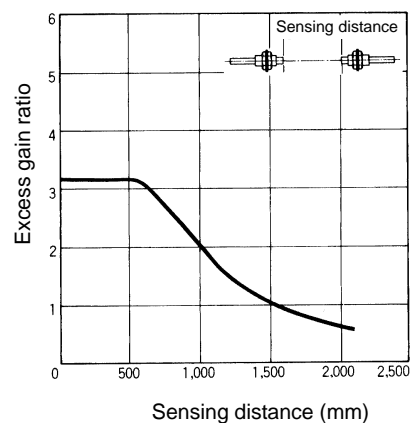

■ EXCESS GAIN RATIO (CONT.)

Through-beam Type, General Purpose

E32-T11L with E39-F1 and E3X-NH amplifier

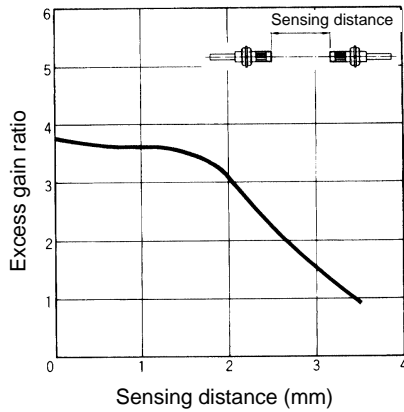

E32-T11R with E39-F2 and E3X-NH amplifier

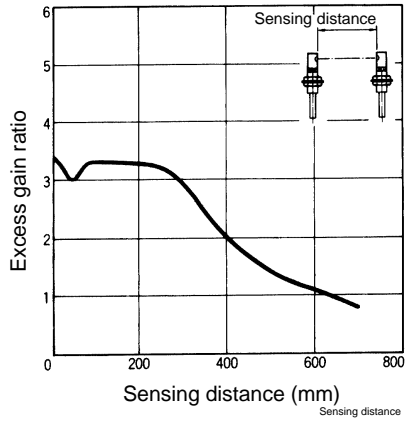

E32-T11L with E39-F3 and E3X-NH amplifier

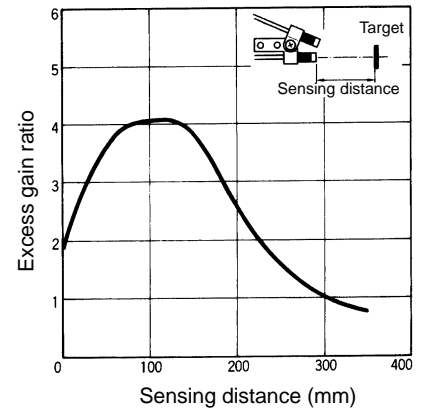

E32-T11L with E3X-NVG amplifier

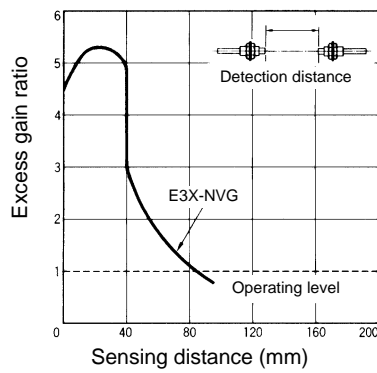

E32-T11R with E3X-NH amplifier

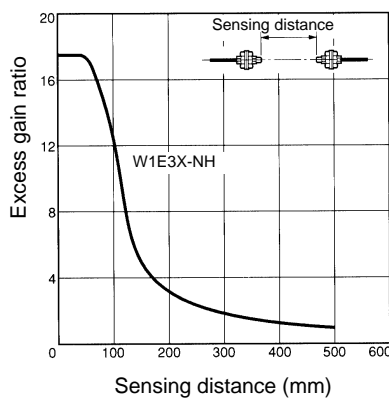

E32-T12L with E3X-A, E3X-F and E3X-VG amplifiers

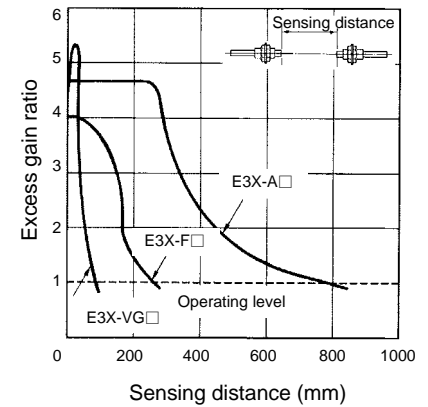

E32-T17L with E3X-A, E3X-F and E3X-VG amplifiers

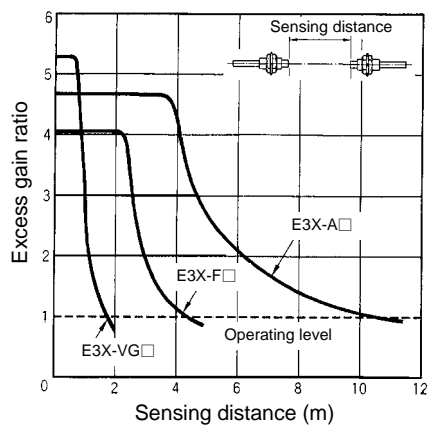

E32-T17L with E3X-H11 amplifier

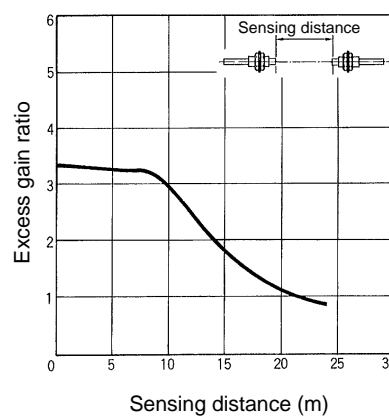

E32-T17L with E3X-NH amplifier

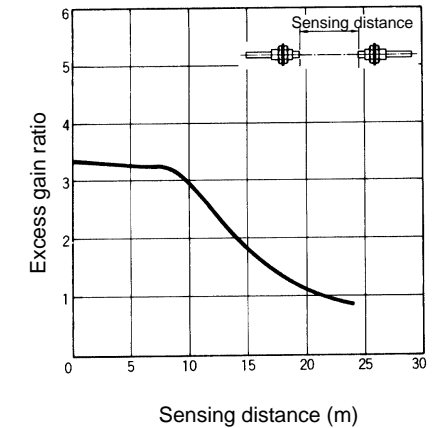

**EXCESS GAIN RATIO (CONT.)**

**Through-beam Type, General Purpose**

**E32-T21 with E3X-A amplifier**

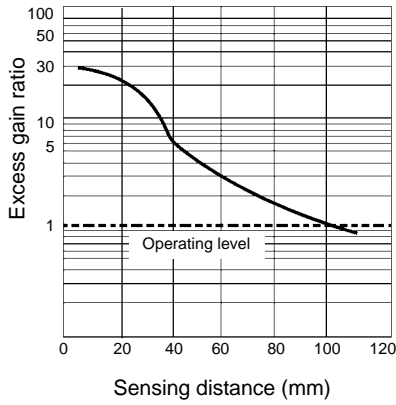

**E32-T21 with E3JU-XR amplifier**

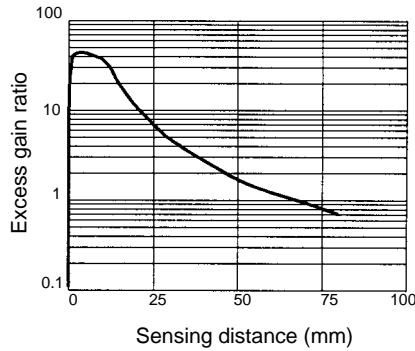

**E32-T21 with E3X-H amplifier**

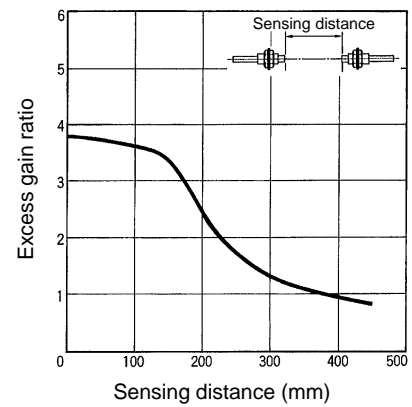

**E32-T21L with E3X-A, E3X-F and E3X-VG amplifiers**

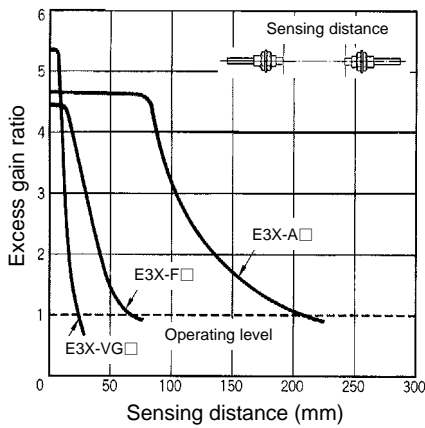

**E32-T21L with E3X-NH amplifier**

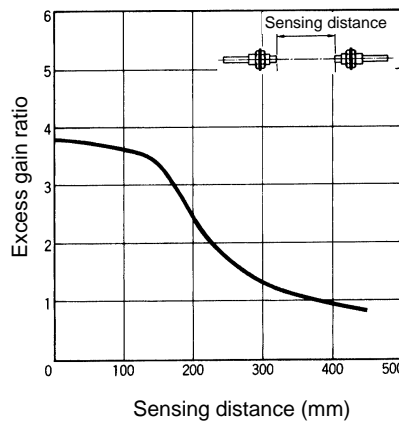

**E32-T21R with E3X-NH amplifier**

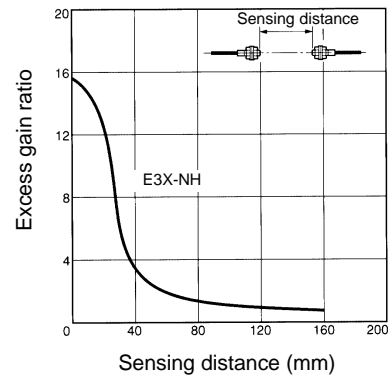

**E32-T22 with E3X-A and E3S-X3 amplifiers**

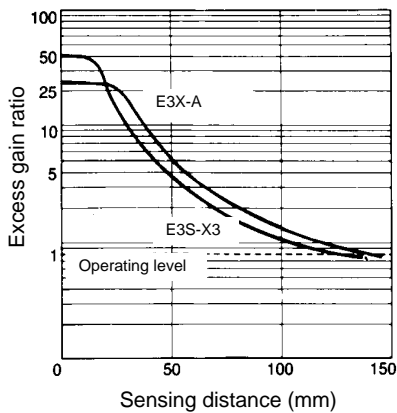

**E32-T22 with E3JU-XR amplifier**

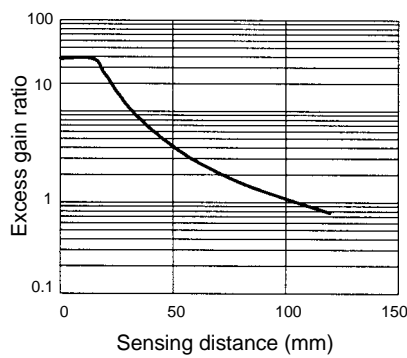

**E32-T22L with E3X-A, E3X-F and E3X-VG amplifiers**

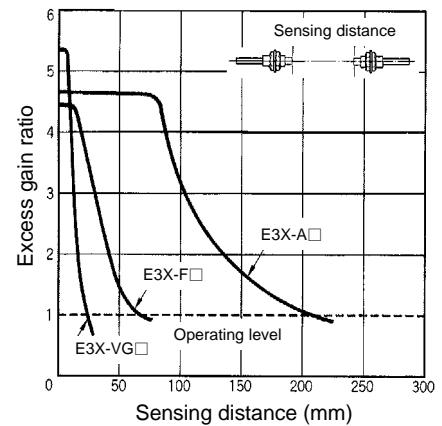

■ EXCESS GAIN RATIO (CONT.)

Through-beam Type, General Purpose

E32-TC50/TC200/TC500/TC1000 with E3X-A11 amplifier

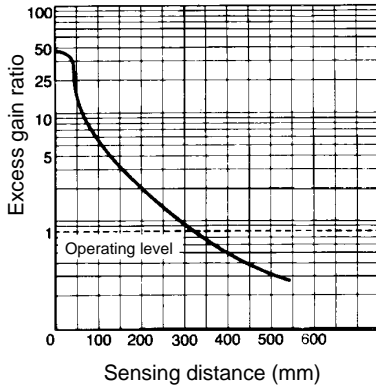

E32-TC200 with E39-F1 and E3X-A amplifier

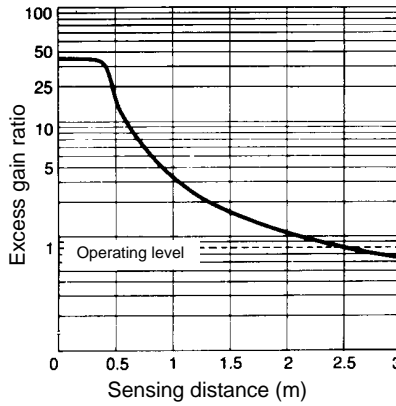

E32-TC200 with E39-F2 and E3X-A amplifier

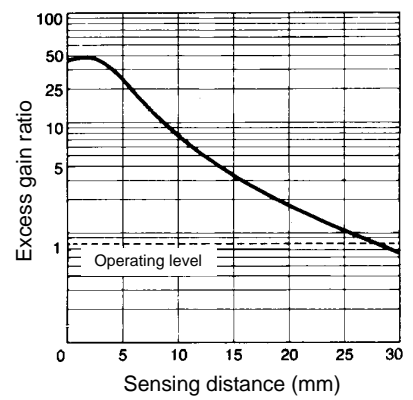

E32-TC200 with E3X-H11 amplifier

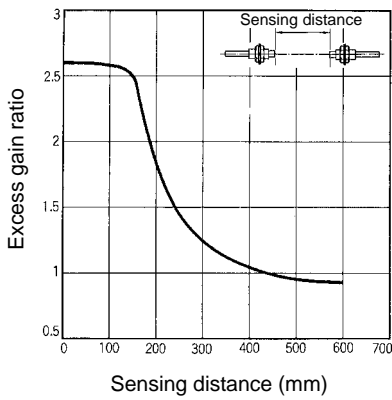

E32-TC200 with E39-F1 and E3X-H11 amplifier

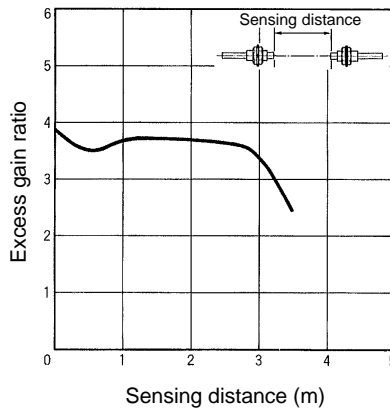

E32-TC200 with E3X-DA amplifier

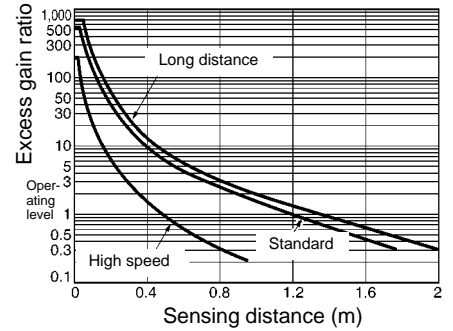

E32-TC200 with E3X-NM and E3X-NT amplifiers

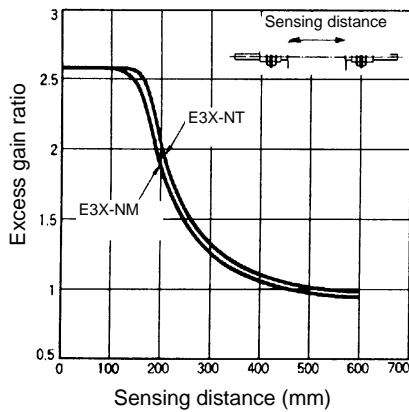

E32-TC200 with E3X-NH amplifier

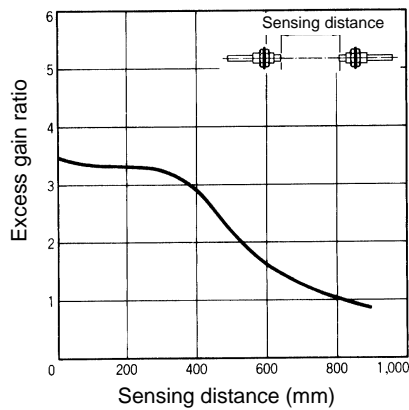

E32-TC200 with E39-F1 and E3X-NH amplifier

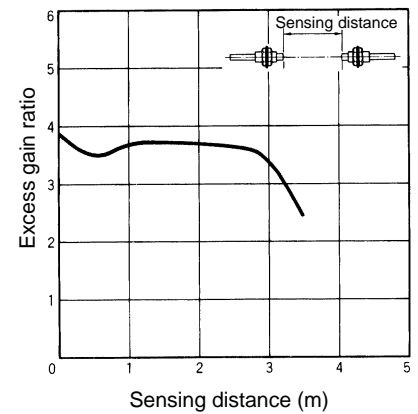

**EXCESS GAIN RATIO (CONT.)**

**Through-beam Type, General Purpose**

**E32-TC200 with E3X-NV amplifier**

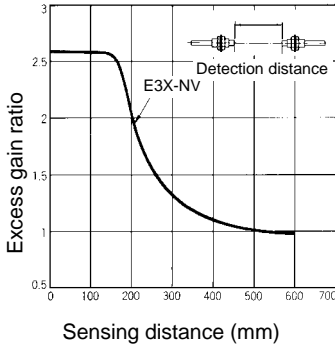

**E32-TC200 with E3JU-XR amplifier**

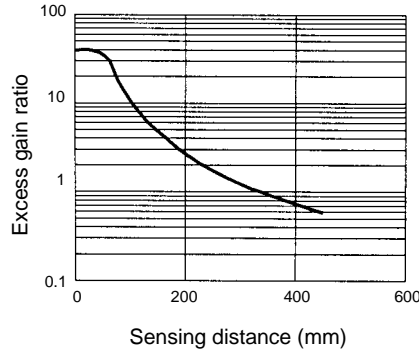

**E32-TC200 with E3XA-CC4A analog output amplifier**

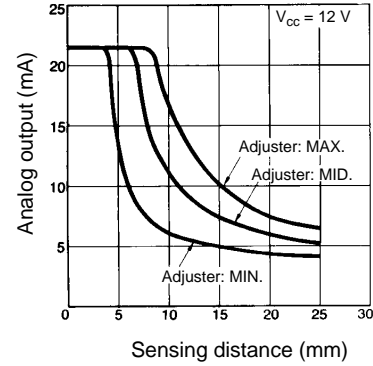

**E32-TC200 with E3X-DA amplifier in analog mode**

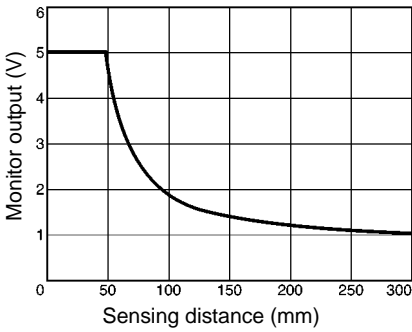

**E32-TC200A with E3X-A11 amplifier**

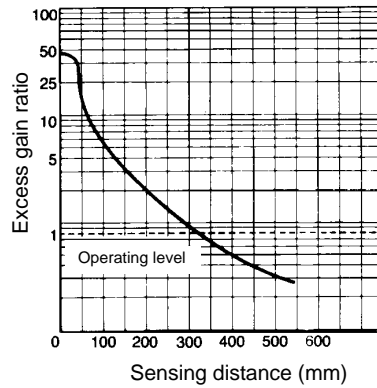

**E32-TC200A with E3XA-CC4A analog output amplifier**

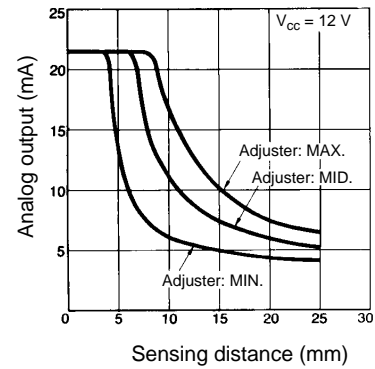

**E32-TC200C with E3XA-CC4A analog output amplifier**

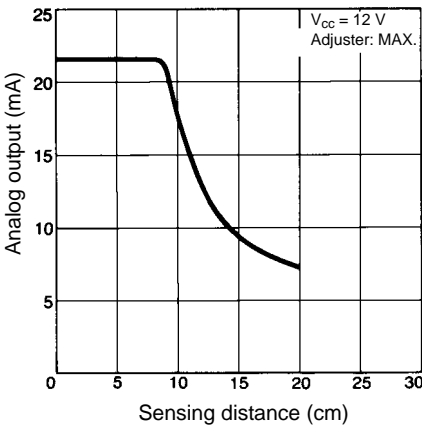

**E32-TC200E with E3X-A11 amplifier**

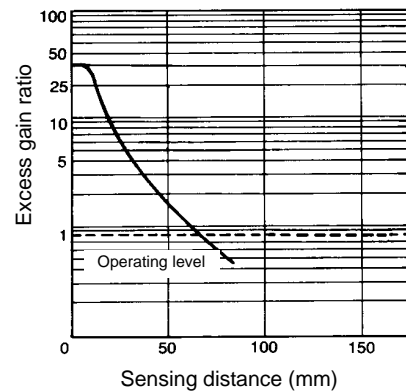

**E32-TC200E with E3XA-CC4A analog output amplifier**

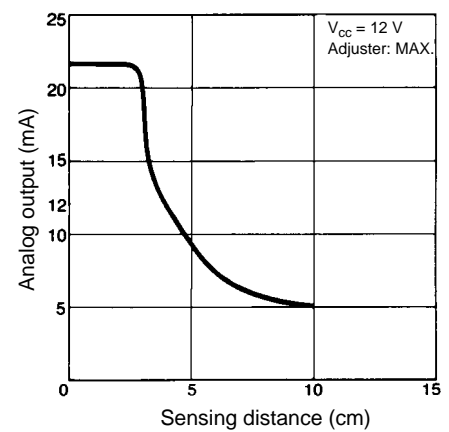



■ EXCESS GAIN RATIO (CONT.)

Through-beam, Armored Type

E32-UTAT1-3F with E3X-A11 amplifier

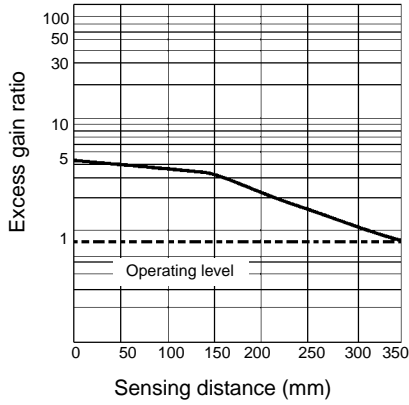

E32-UTAT1-3F with E3JU-XR amplifier

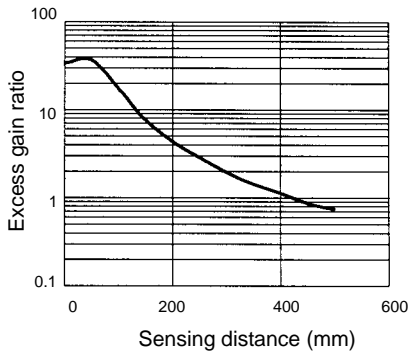

E32-UTAT1-6F with E3X-A11 amplifier

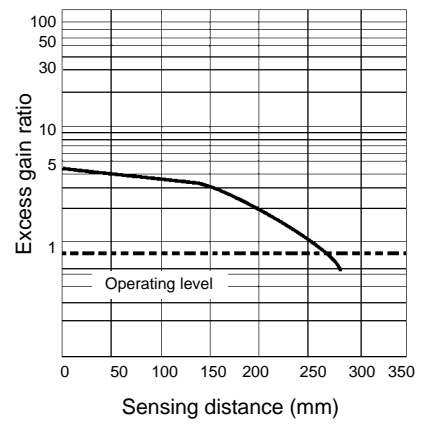

E32-UTAT1-6F with E3JU-XR amplifier

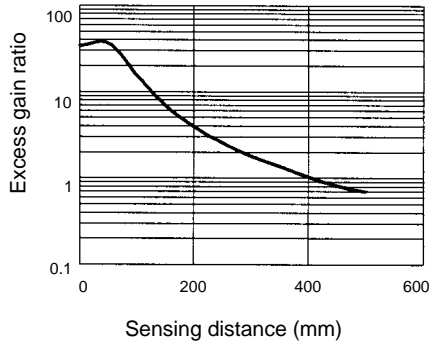

E32-UTBT1-3F with E3JU-X amplifier

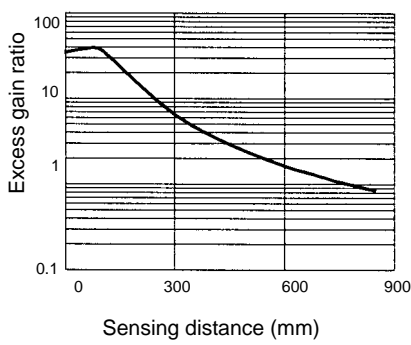

E32-UTBT1-6F with E3JU-X amplifier

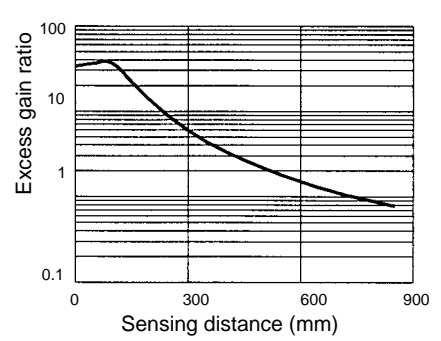

Through-beam, Probe Type

E32-TC200B/TC200B4 with E3X-A11 amplifier

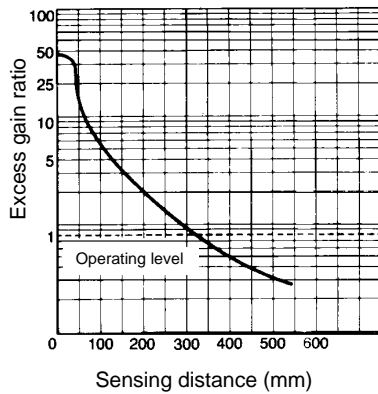

E32-TC200B with E3XA-CC4A analog output amplifier

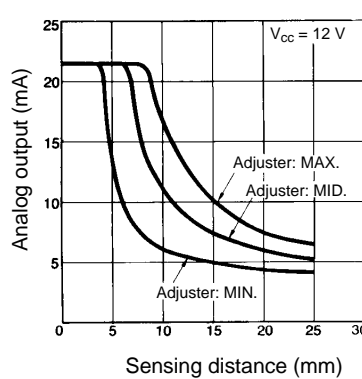

E32-TC200D with E3XA-CC4A analog output amplifier

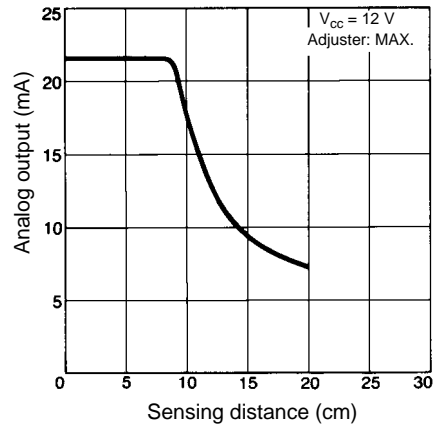

■ EXCESS GAIN RATIO (CONT.)

Through-beam, Probe Type

E32-TC200F/TC200F4 with E3X-A11 amplifier

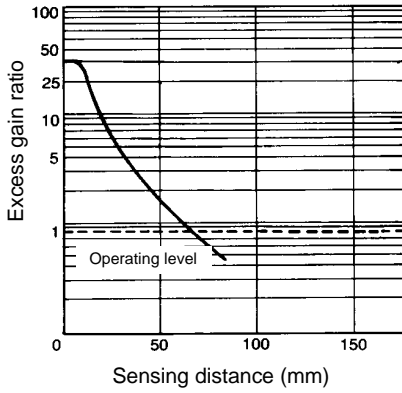

E32-TC200F with E3XA-CC4A analog output amplifier

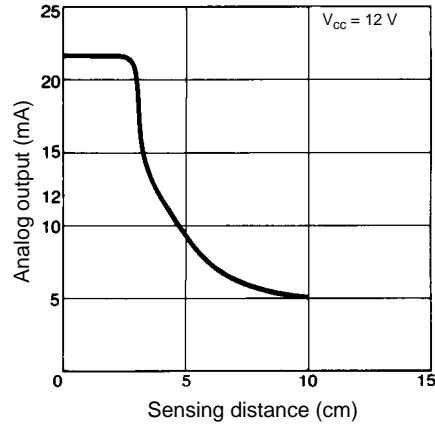

Through-beam, Side Beam Type

E32-T14 with E3X-A11 amplifier

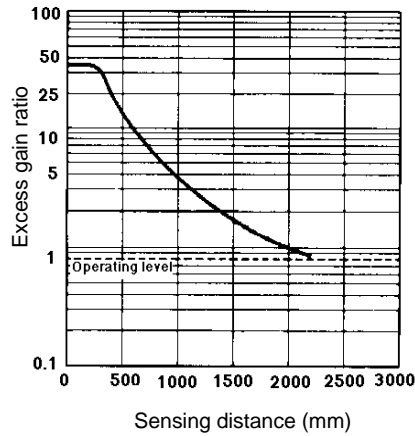

E32-T14L with E3X-A, E3X-F and E3X-VG amplifiers

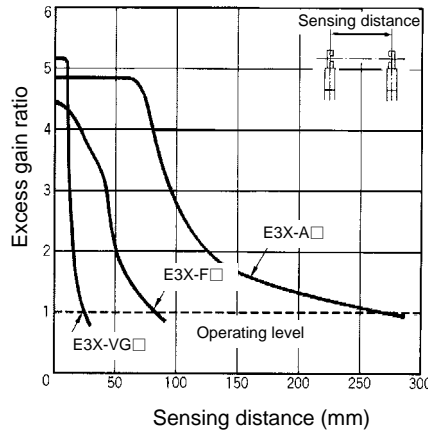

E32-T14L with E3X-H11 amplifier

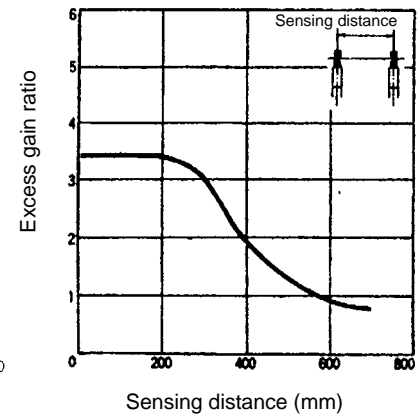

■ EXCESS GAIN RATIO (CONT.)

Through-beam, Side Sensing Type

E32-T14L with E3X-NH amplifier

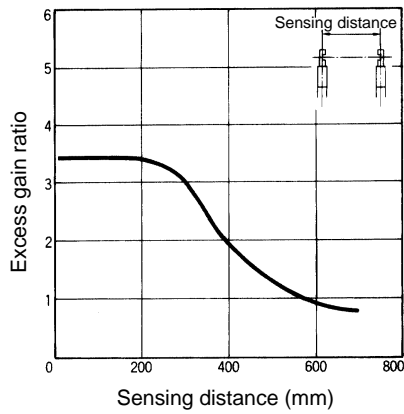

E32-T16 with E3X-A11 amplifier

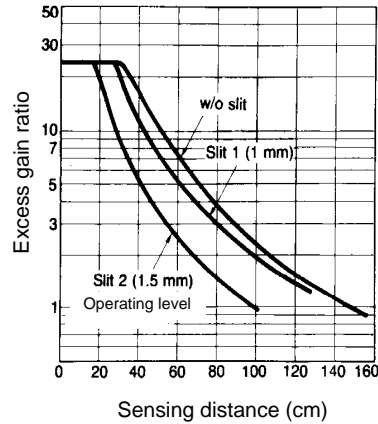

E32-T16 with E3X-NH amplifier

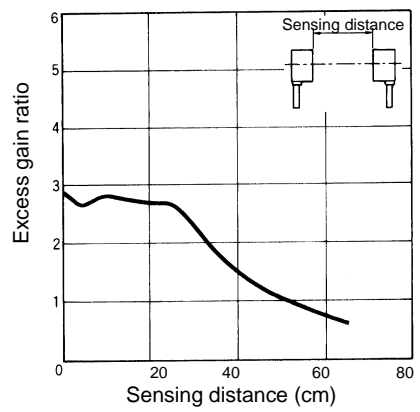

E32-T16 with E3X-H11 amplifier

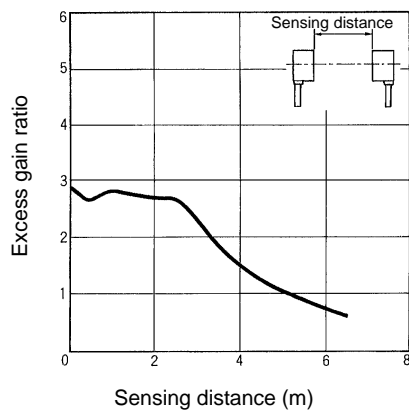

E32-T16 with E3XA-CC4A analog output amplifier

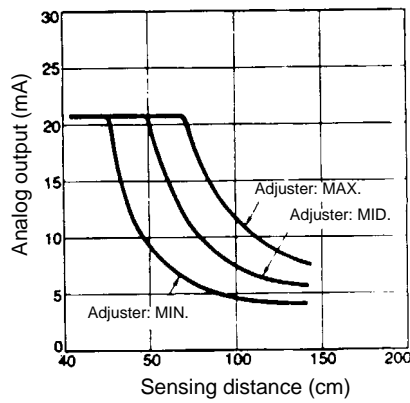

E32-T16 with slits and E3XA-CC4A amplifier

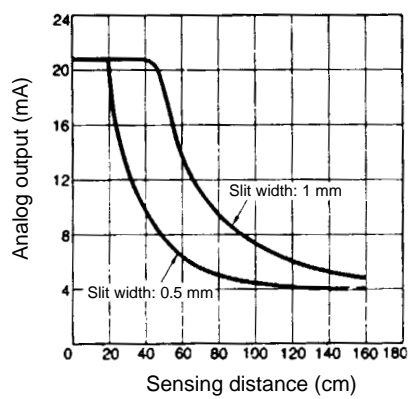

E32-T24 with E3X-A11 and E3S-X3 amplifiers

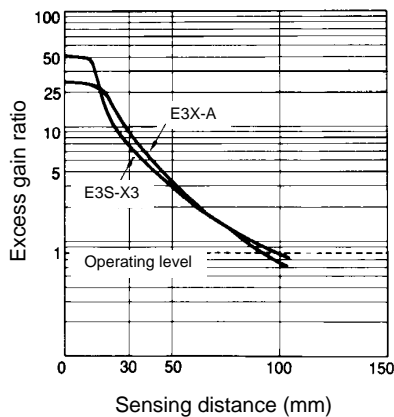

**■ EXCESS GAIN RATIO (CONT.)**

Through-beam, High Temperature Type

**E32-T51 with E3X-A11 amplifier**

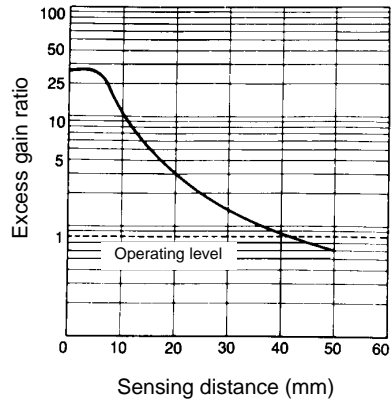

**E32-T51 with E3X-NH amplifier**

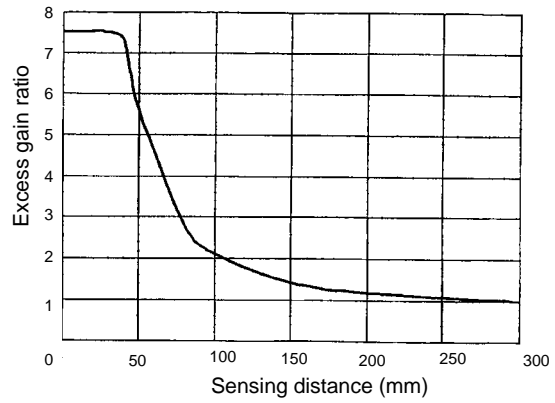

**E32-T51 with E39-F1 and E3X-NH amplifier**

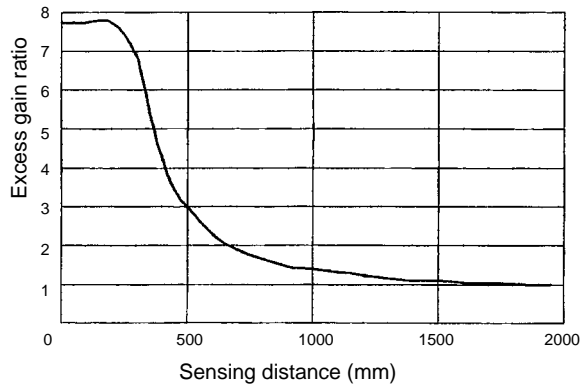

**E32-T51 with E3JU-XR amplifier**

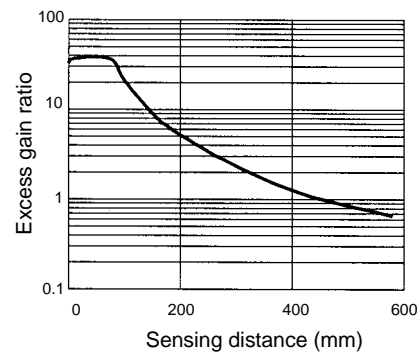

**E32-T61 with E3X-A and E3S-X3 amplifiers**

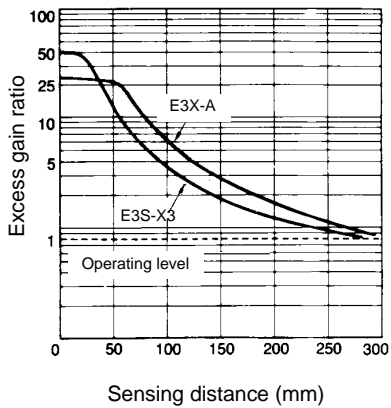

■ EXCESS GAIN RATIO (CONT.)

Through-beam, Special Purpose Type

E32-M21 with E3X-A11 amplifier

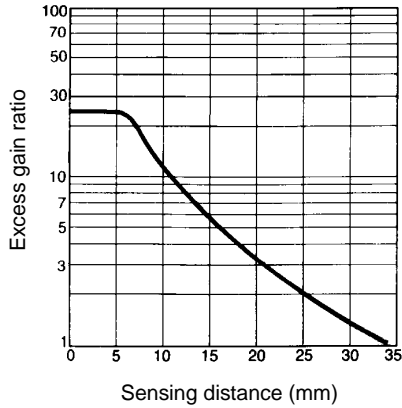

E32-M21 with E3XA-CC4A analog output amplifier

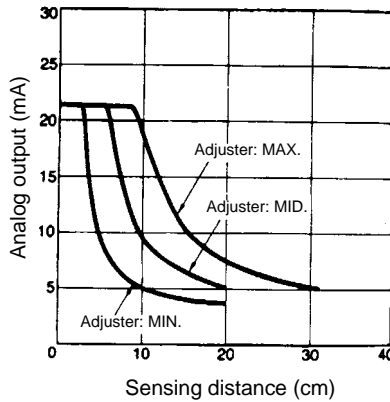

E32-T12F with E3X-A, E3X-F and E3X-VG amplifiers

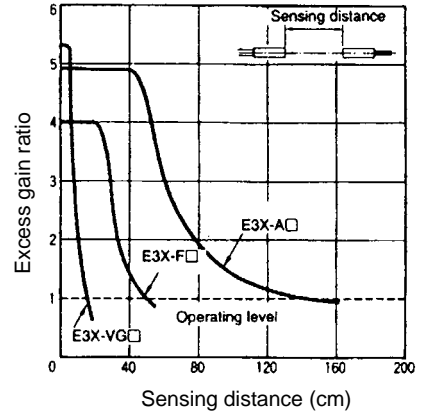

E32-T22S with E3X-NH amplifier

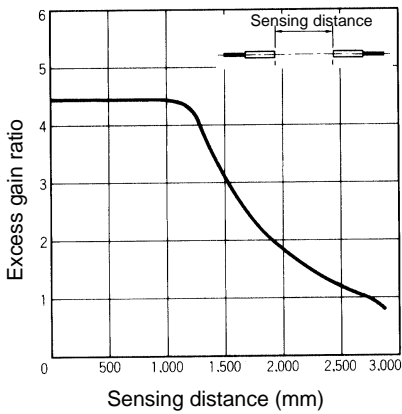

E32-T24S with E3X-NH amplifier

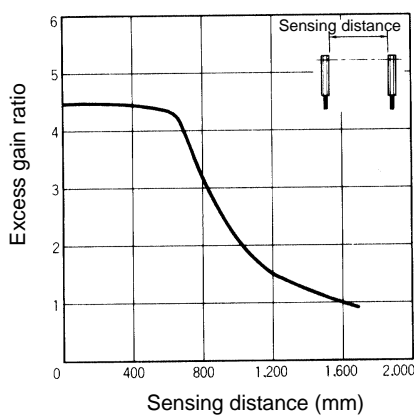

E32-T84S with E3X-NH amplifier

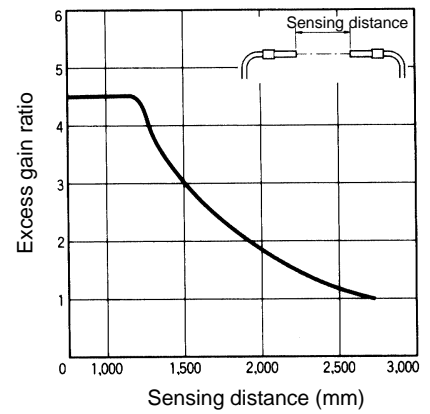

Diffuse, General Purpose

E32-CC200 with E3XA-CC4A analog output amplifier

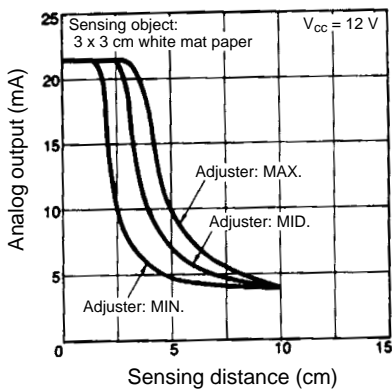

E32-D11 with E3X-A11 amplifier

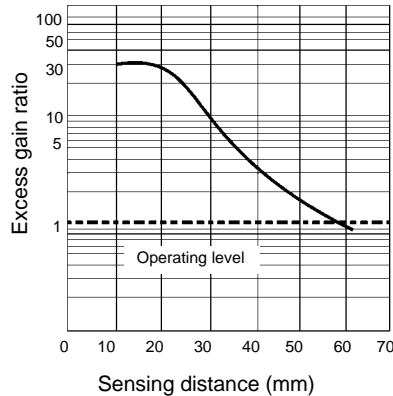

E32-D11 with E3JU-XR amplifier

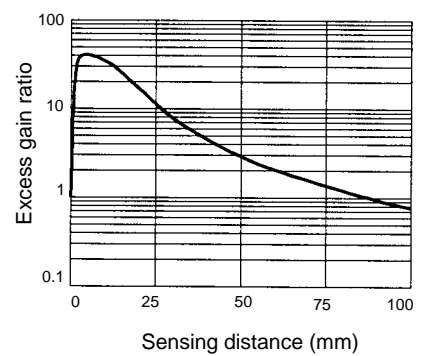

**EXCESS GAIN RATIO (CONT.)**

Diffuse, General Purpose

**E32-D11L with E3X-A, E3X-F and E3X-VG amplifiers**

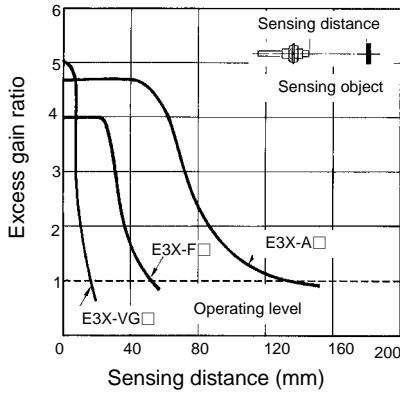

**E32-D11L with E3X-H11 amplifier**

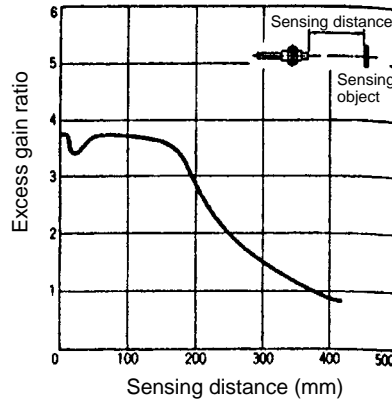

**E32-D11L with E3X-NH amplifier**

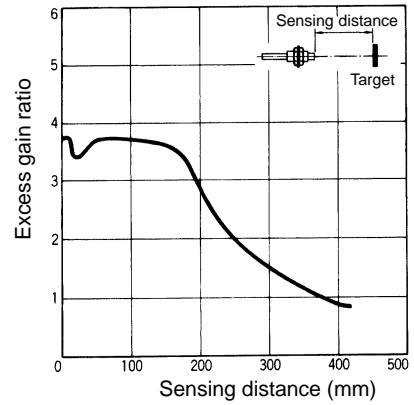

**E32-D11L with E3X-NVG amplifier**

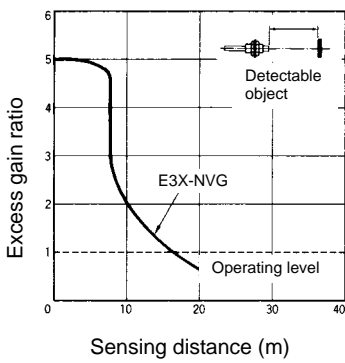

**E32-D11L with E3X-H11 amplifier**

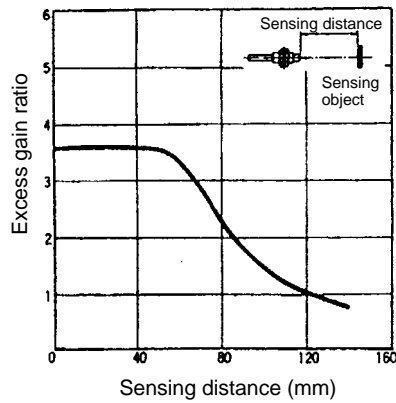

**E32-D11R with E3X-NH amplifier**

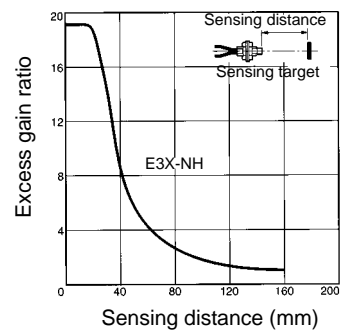

**E32-D21 with E3X-A11 amplifier**

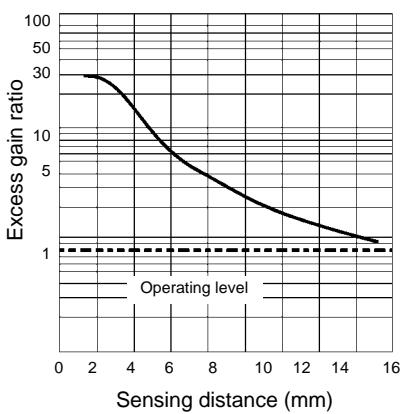

**E32-D21 with E3JU-XR amplifier**

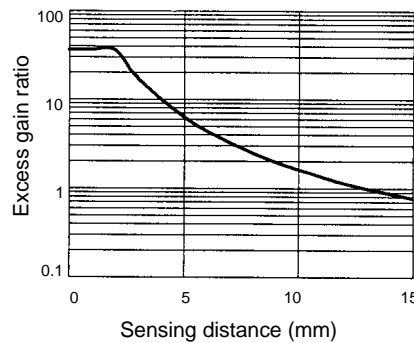

**E32-D21L with E3X-A, E3X-F, and E3X-VG amplifiers**

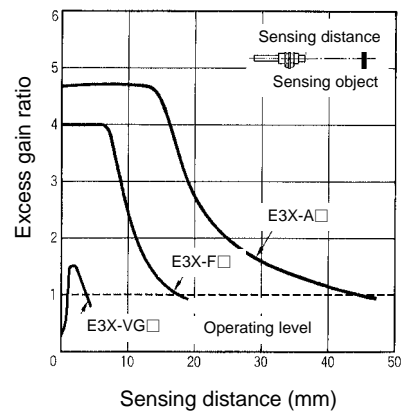

■ EXCESS GAIN RATIO (CONT.)

Diffuse, General Purpose

E32-D21L with E3X-DA amplifier

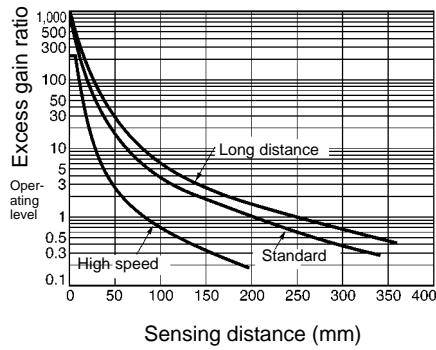

E32-D21L with E3X-NA amplifier

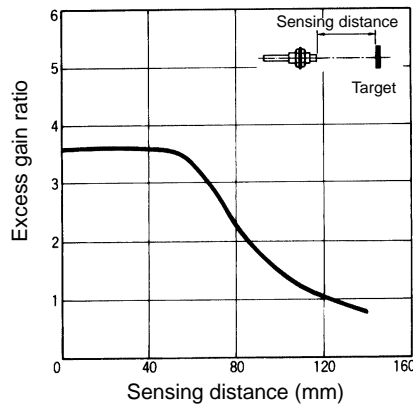

E32-D21R with E3X-NH amplifier

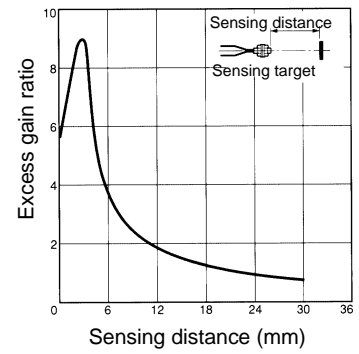

E32-D21L with E3X-A, E3X-F and E3X-V amplifiers

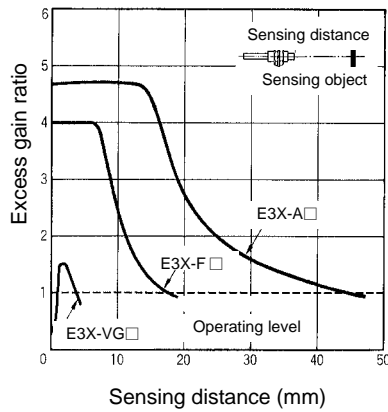

E32-D32 with E3X-A11 amplifier

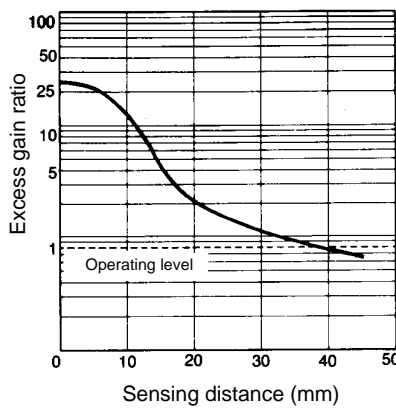

E32-D32 with E3JU-XR amplifier

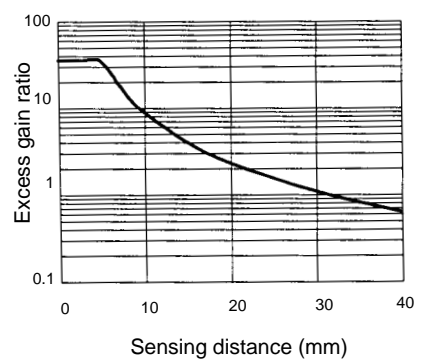

E32-DC50/DC200/DC500/DC1000 with E3X-A11 amplifier

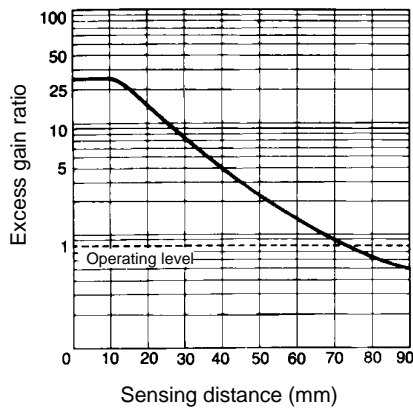

E32-DC200 with E3X-DA amplifier

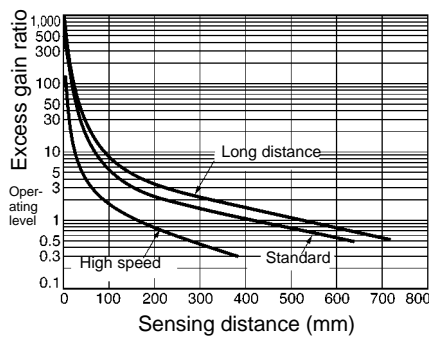

E32-DC200 with E3X-A11 amplifier

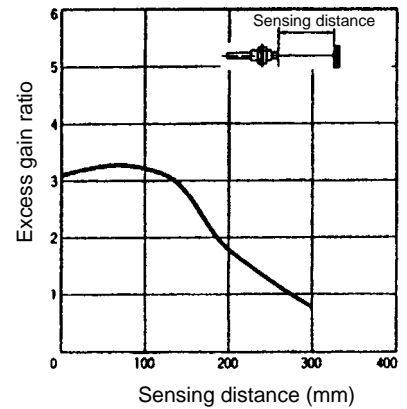

**EXCESS GAIN RATIO (CONT.)**

Diffuse, General Purpose

**E32-DC200 with E3X-NM and E3X-NT amplifiers**

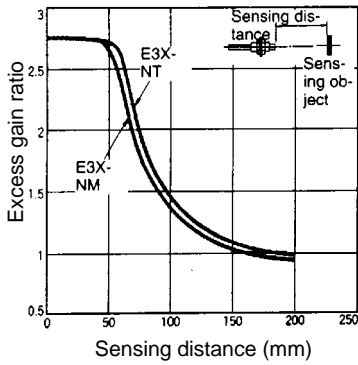

**E32-DC200 with E3X-NH amplifier**

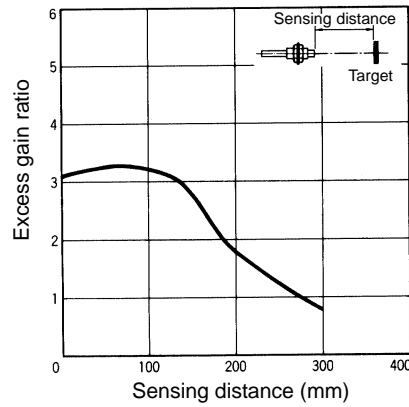

**E32-DC200 with E3X-NV amplifier**

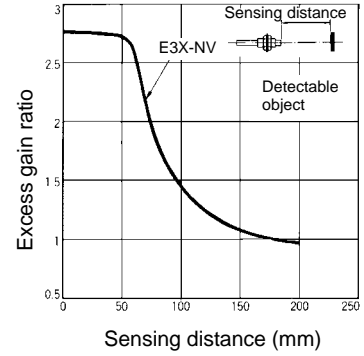

**E32-DC200 with E3JU-XR amplifier**

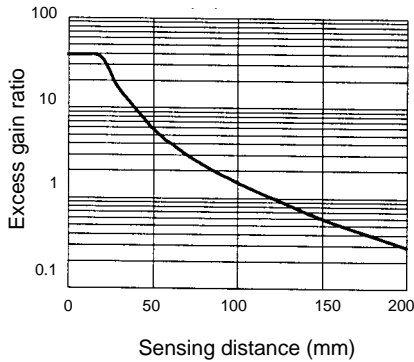

**E32-DC200 with E3XA-CC4A analog output amplifier**

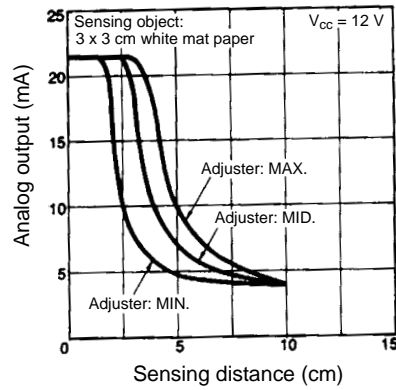

**E32-DC200 with E3X-DA amplifier in analog mode**

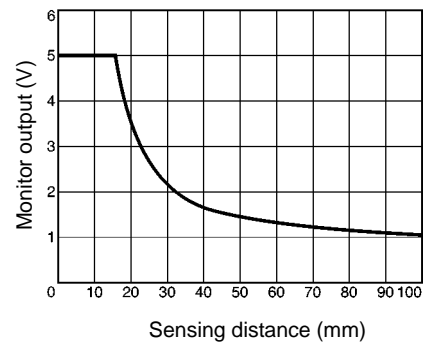

**E32-DC200 with E3XA-CC4A analog output amplifier**

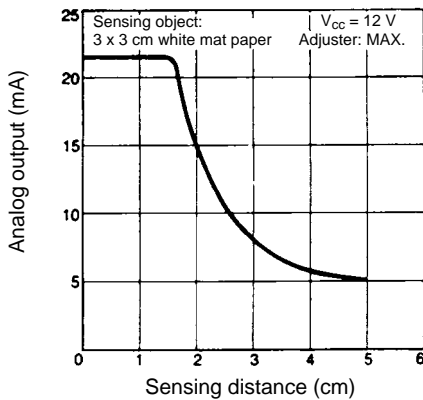

**E32-DC200 with E3XA-CC4A analog output amplifier**

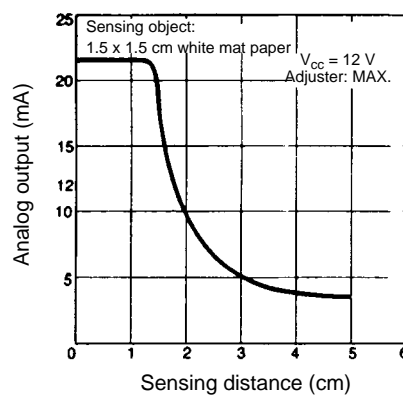



■ EXCESS GAIN RATIO (CONT.)

Diffuse, Armored Type

E32-UDAT1-3F with E3X-A11 amplifier

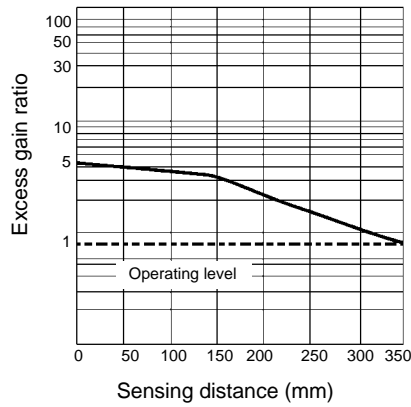

E32-UDAT1-3F with E3JU-XR amplifier

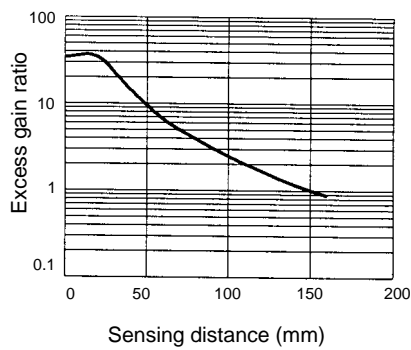

E32-UDAT1-6F with E3X-A11 amplifier

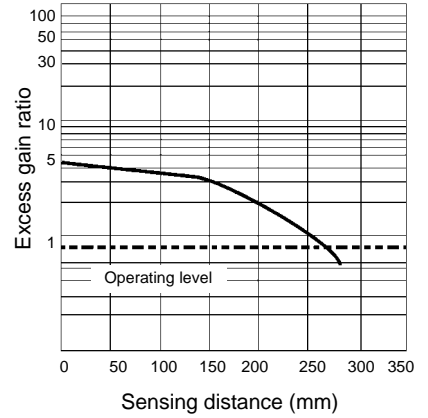

E32-UDAT1-6F with E3X-A11 amplifier

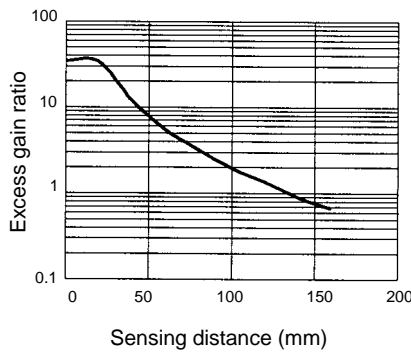

E32-UDBT1-3F with E3JU-X amplifier

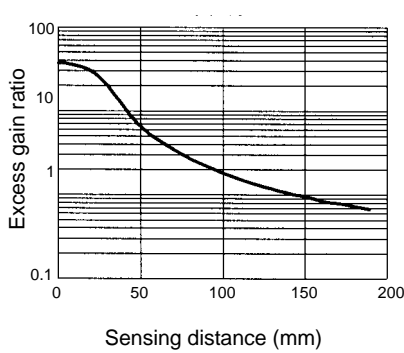

E32-UDBT1-6F with E3JU-X amplifier

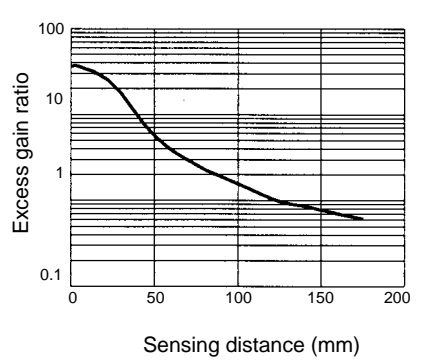

Diffuse, Probe Type

E32-D33 with E3X-A11 amplifier

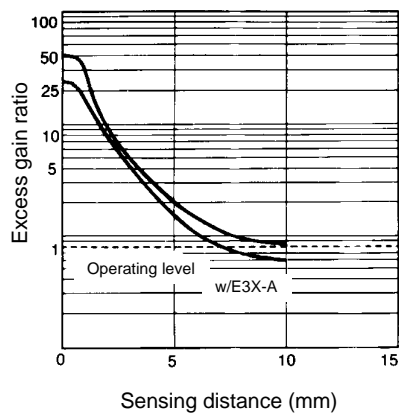

E32-DC200B/B4 with E3XA-CC4A analog amplifier

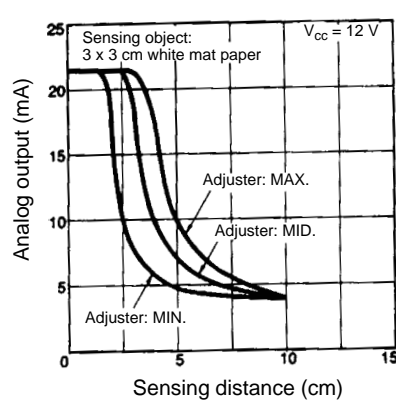

E32-DC200D/D4 with E3XA-CC4A analog amplifier

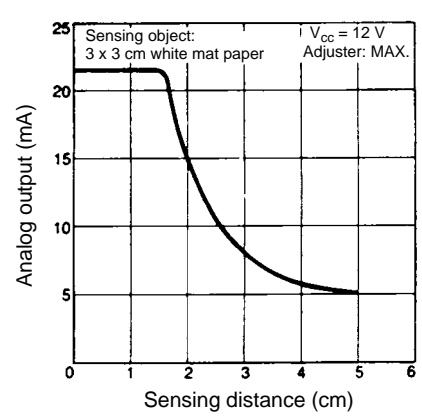

**EXCESS GAIN RATIO (CONT.)**

Diffuse, Probe Type

E32-DC200F/F4 with E3XA-CC4A analog amplifier

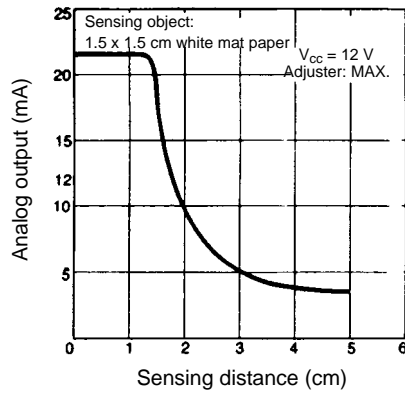

E32-DC9G/E32-DC9G4 with E3X-A11 amplifier

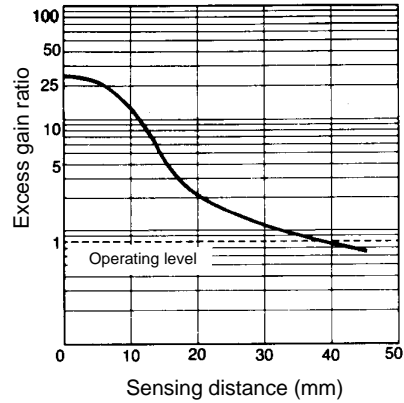

Diffuse, Side Sensing Type

E32-D14L with E3X-AE3X-F and E3X-VG amplifiers

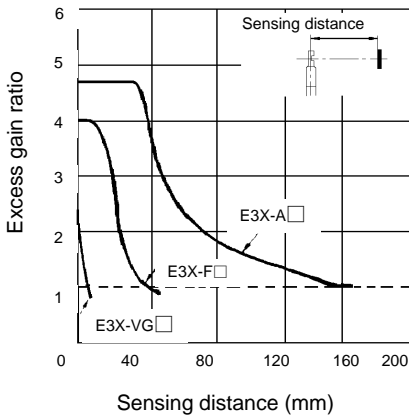

E32-D24 with E3X-A11 amplifier

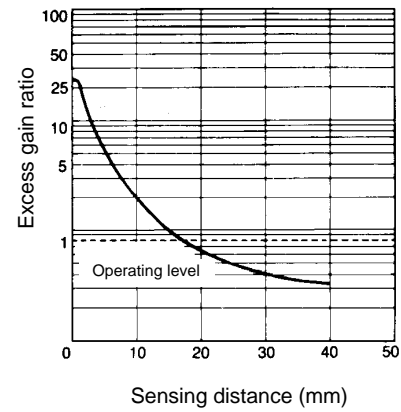

Diffuse, High Temperature Type

E32-D51 with E3X-A11 amplifier

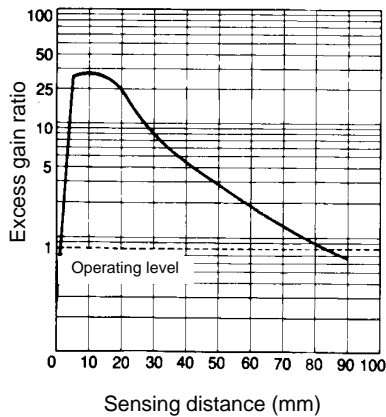

E32-D51 with E3JU-XR amplifier

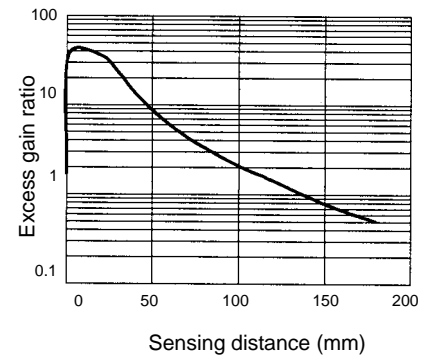

■ EXCESS GAIN RATIO (CONT.)

Diffuse, High Temperature Type

E32-D61 with E3X-A11 amplifier

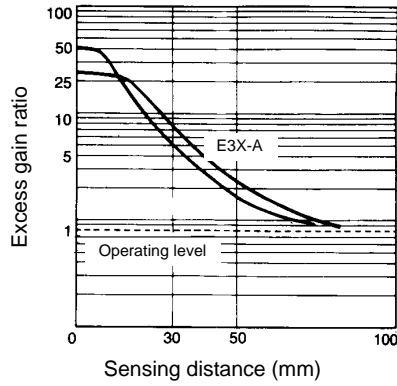

E32-D73 with E3X-A11 amplifier

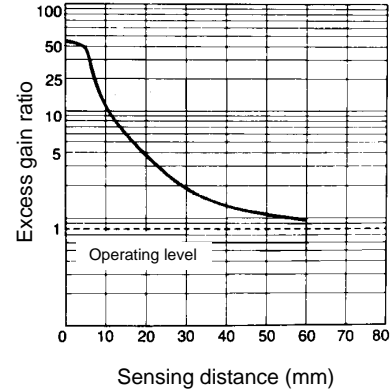

Diffuse, Special Purpose Type

E32-D12F with E3X-A, E3X-F and E3X-VG amplifiers

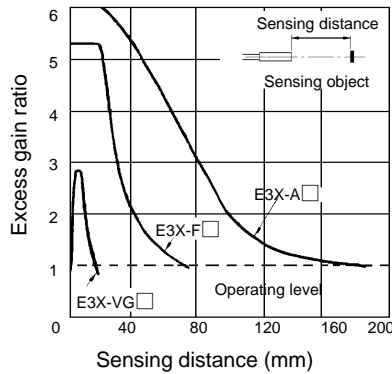

E32-L25, E32-L25A with E3X-A11 amplifier

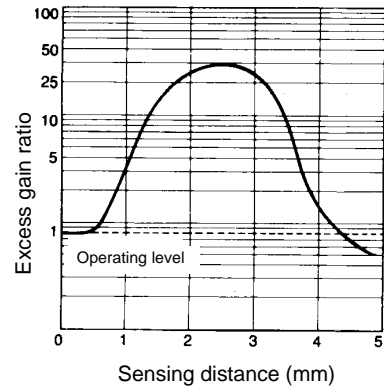

Retroreflective Type

E32-R21 with E3X-A11 amplifier

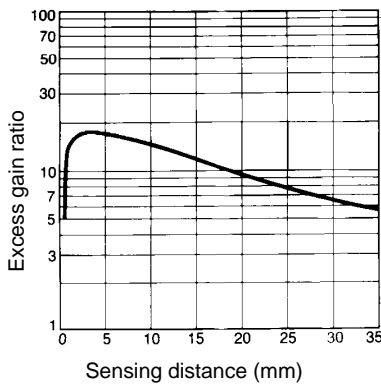

E32-R16 with E3X-A11 amplifier

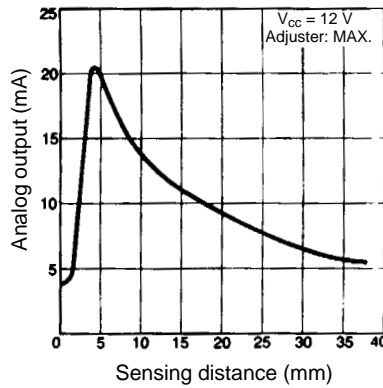

E32-R21 with E3XA-CC4A analog output amplifier

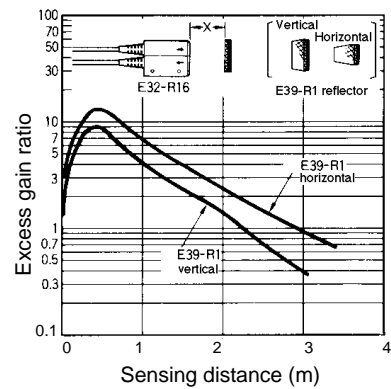

**OPERATING RANGE**

**Through-beam, General Purpose Type**

**E32-T11 with E3X-DA amplifier**

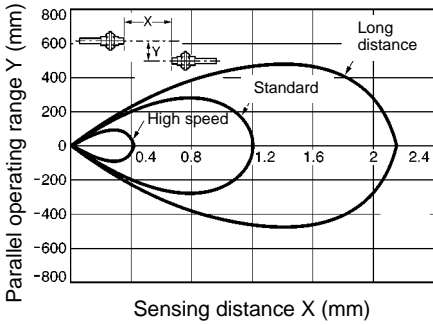

**E32-T11 with E3JU-XR amplifier**

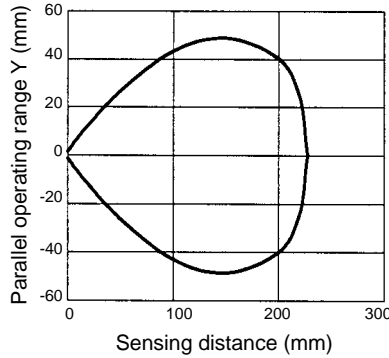

**E32-T11 with E3X-NH amplifier**

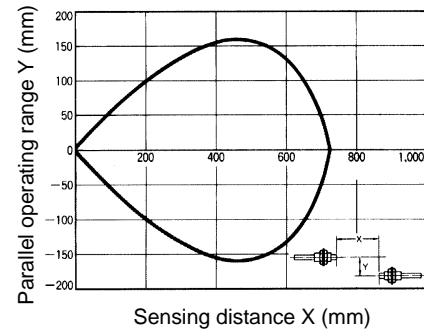

**E32-T11L with E3X-A, E3X-F, and E3X-VG amplifiers**

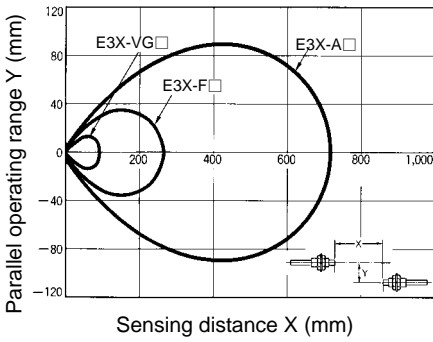

**E32-T11L with E39-F1 and E3X-A, E3X-F, and E3X-VG amplifiers**

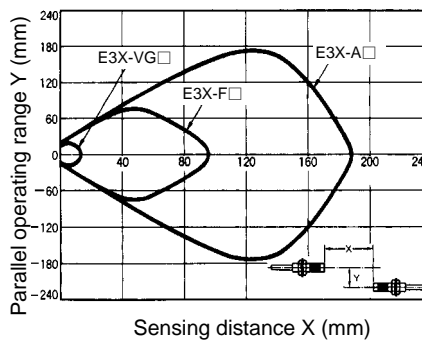

**E32-T11L with E39-F2 and E3X-A, E3X-F and E3X-VG amplifiers**

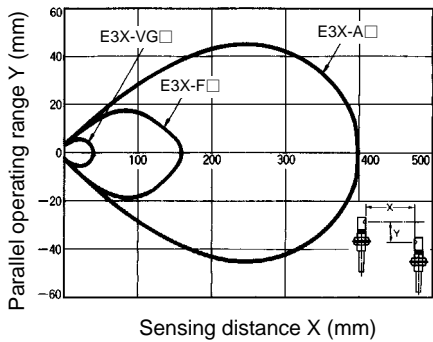

**E32-T11L with E39-F3 and E3X-A and E3X-F amplifiers**

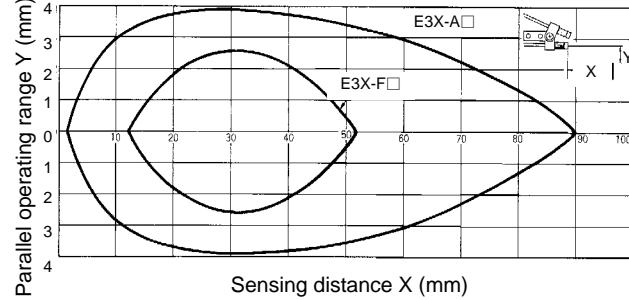

**E32-T11L with E3X-H11 amplifier**

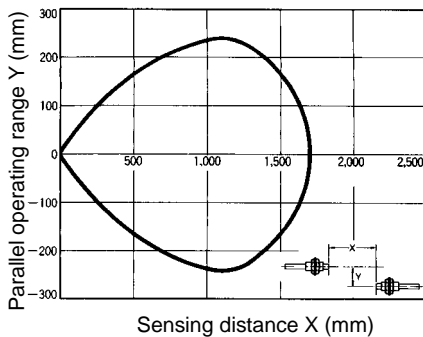

**E32-T11L with E39-F1 and E3X-H11 amplifier**

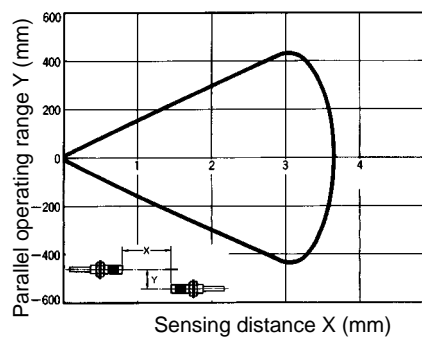

■ OPERATING RANGE (CONT.)

Through-beam, General Purpose Type

E32-T11L with E39-F2 and E3X-H11 amplifier

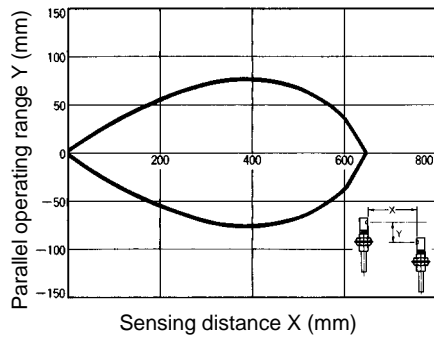

E32-T11L with E3X-NH amplifier

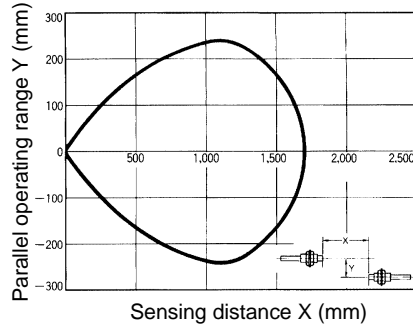

E32-T11L with E39-F1 and E3X-NH amplifier

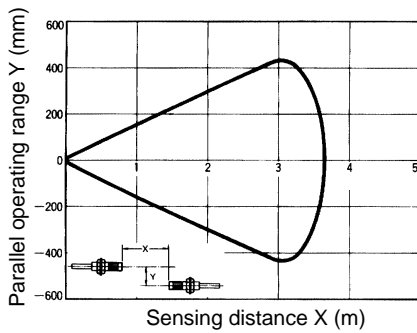

E32-T11L with E39-F2 and E3X-NH amplifier

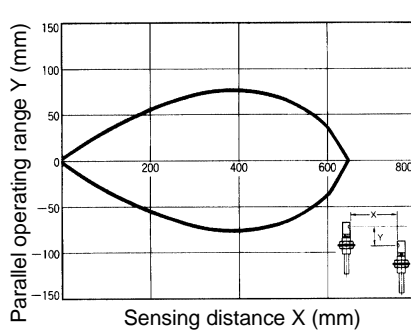

E32-T11L with E39-F3 and E3X-NH amplifier

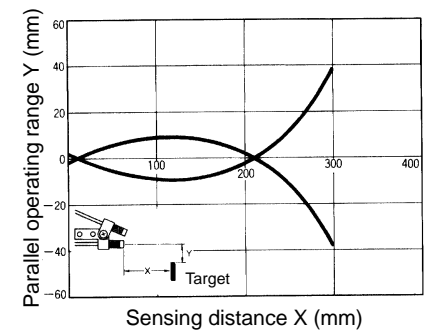

E32-T11L with E3X-NVG amplifier

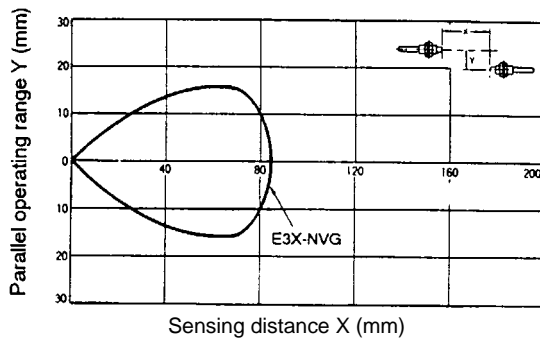

E32-T11R with E3X-NH amplifier

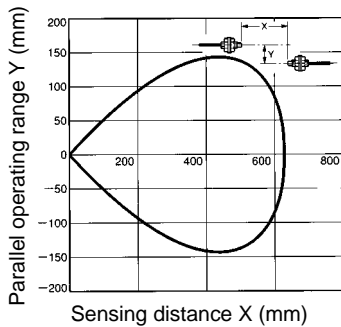

E32-T11R with E3X-DA amplifier

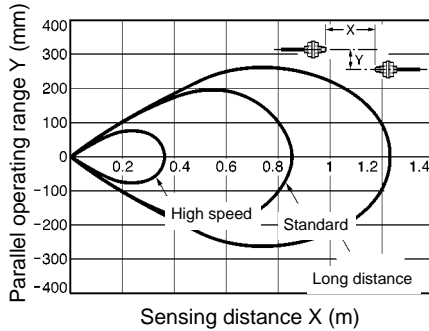

**OPERATING RANGE (CONT.)**

Through-beam, general purpose type

**E32-T12L with E3X-A, E3X-F, and E3X-VG amplifiers**

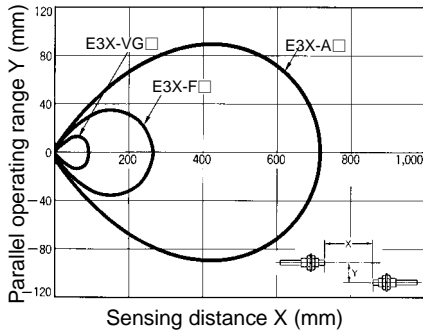

**E32-T12L with E3X-NVG amplifier**

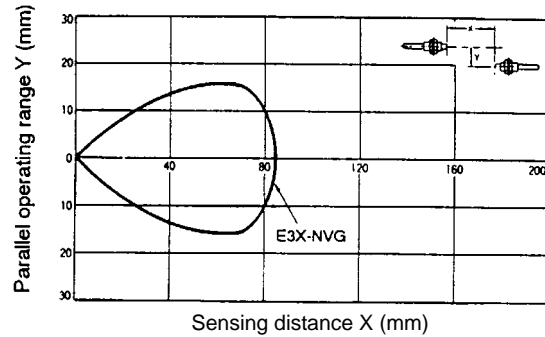

**E32-T17L with E3X-A, E3X-F and E3X-VG amplifiers**

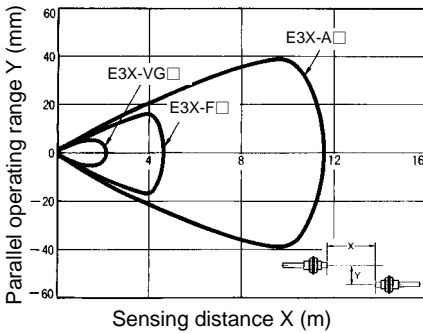

**E32-T17L with E3X-H11 amplifier**

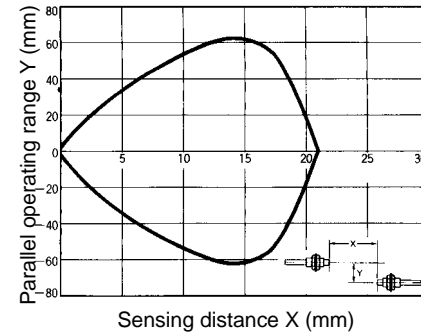

**E32-T17L with E3X-NH amplifier**

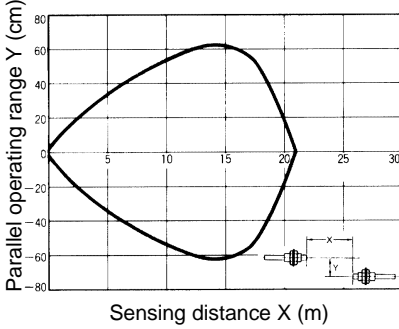

**E32-T21 with E3JU-XR amplifier**

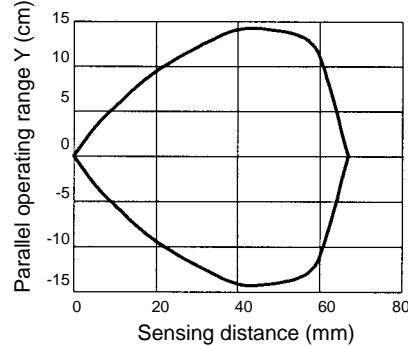

**E32-T21 with E3X-NH amplifier**

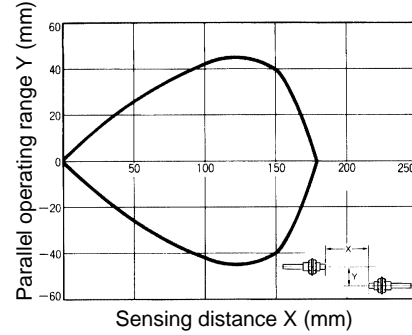

**E32-T21L with E3X-A, E3X-F, and E3X-VG amplifiers**

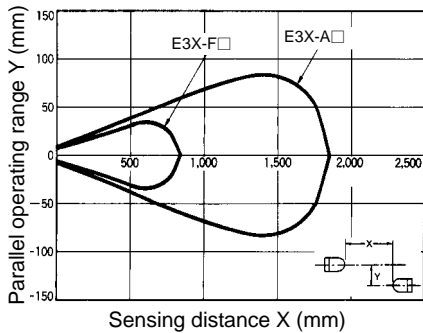

**E32-T21L with E3X-H11 amplifier**

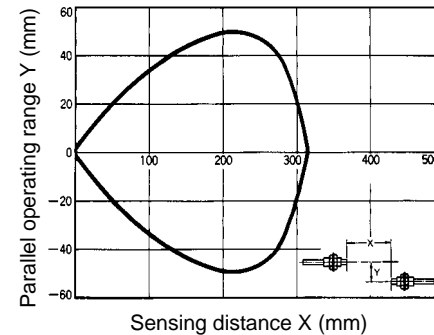

■ OPERATING RANGE (CONT.)

Through-beam, General Purpose Type

E32-T21L with E3X-NH amplifier

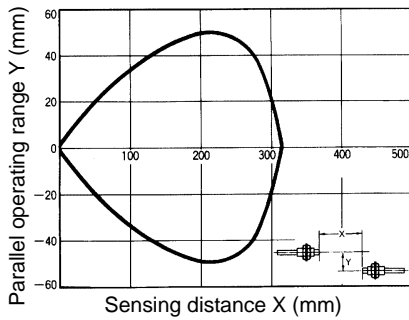

E32-T21R with E3X-NH amplifier

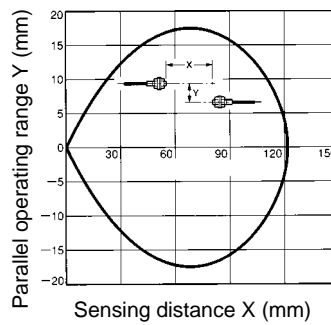

E32-T22 with E3X-A, E3X-F, and E3X-VG amplifiers

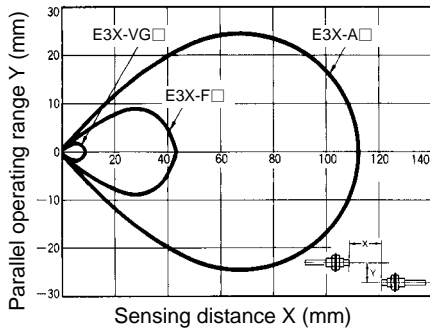

E32-T22 with E3X-NH amplifier

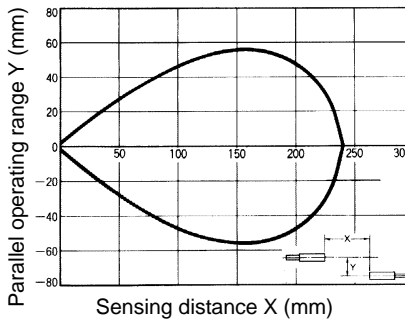

E32-T22 with E3JU-XR amplifier

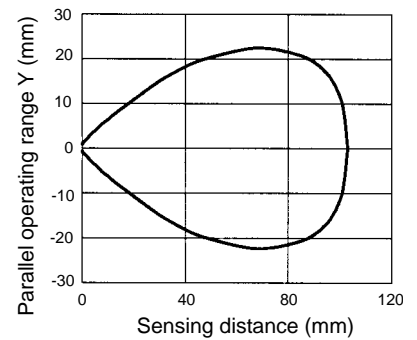

E32-T22L with E3X-A, E3X-F, and E3X-VG amplifiers

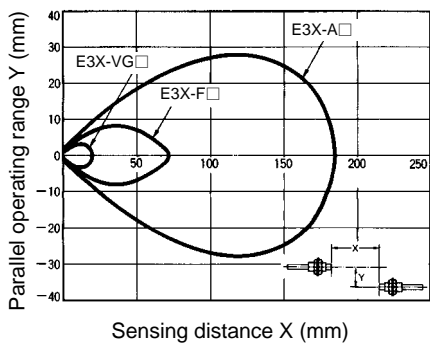

E32-TC50 with E3X-A11 amplifier

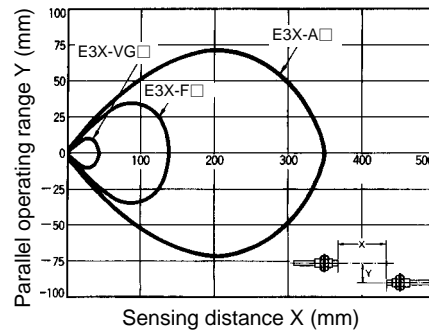

E32-TC200 with E3X-A11 amplifier

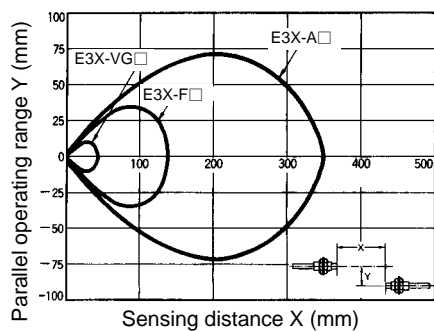

E32-TC200 with E3X-DA amplifier

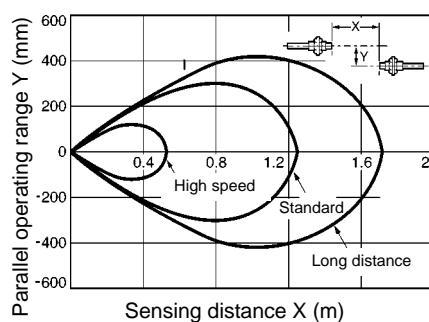

■ OPERATING RANGE (CONT.)

Through-beam, General Purpose Type

E32-TC200 with E3X-H11 amplifier

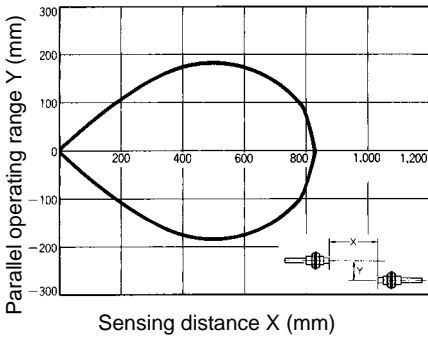

E32-TC200 with E3X-NM and E3X-NT amplifiers

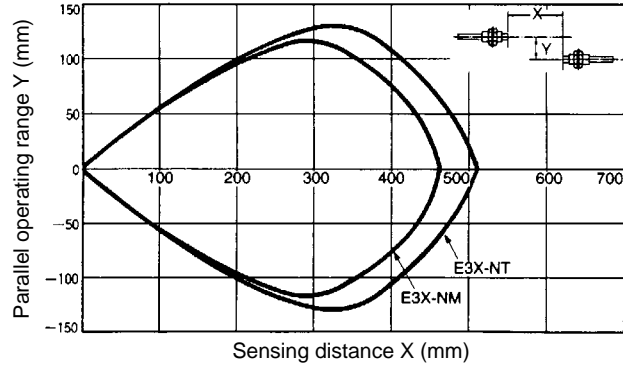

E32-TC200 with E3X-NH amplifier

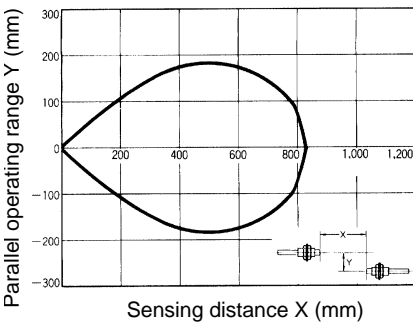

E32-TC200 with E39-F2 and E3X-NH amplifier

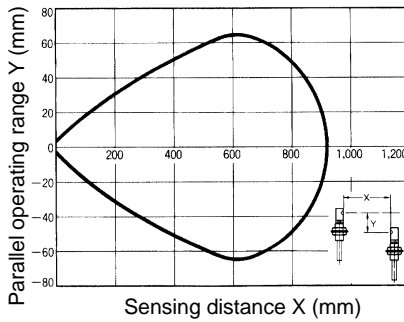

E32-TC200 with E3JU-XR amplifier

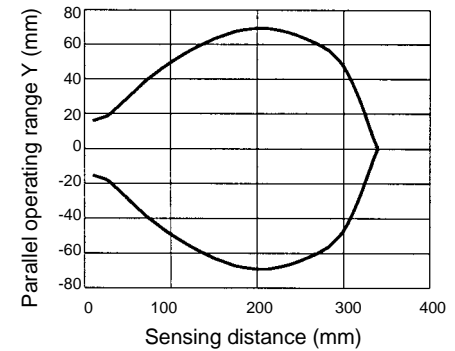

E32-TC200 with E3X-NV amplifier

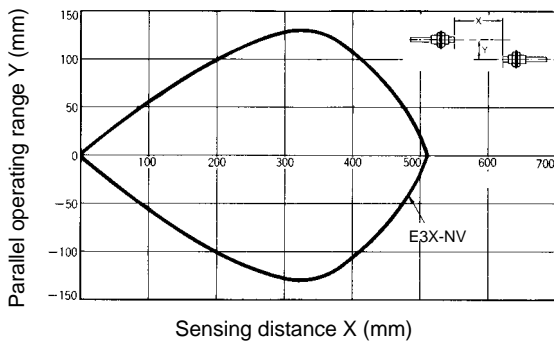

E32-TC200A with E3X-A, E3X-F, and E3X-VG amplifiers

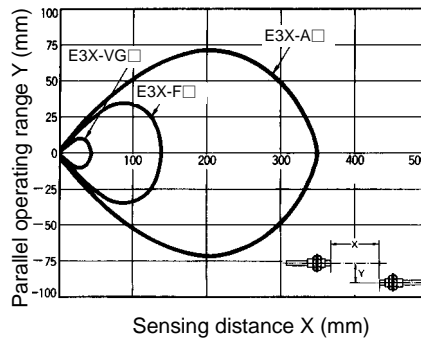



**OPERATING RANGE (CONT.)**

**Through-beam, General Purpose Type**

**E32-TC200C with E3X-A11 amplifier**

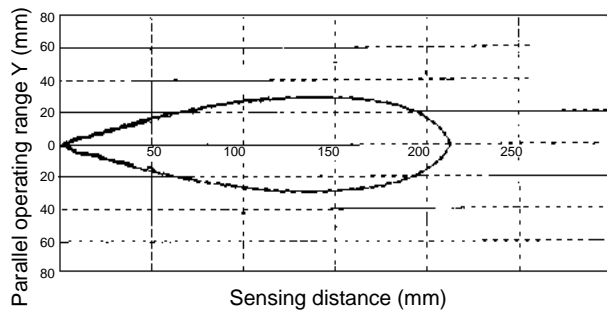

**E32-TC200E with E3X-A, E3X-F and E3X-VG amplifiers**

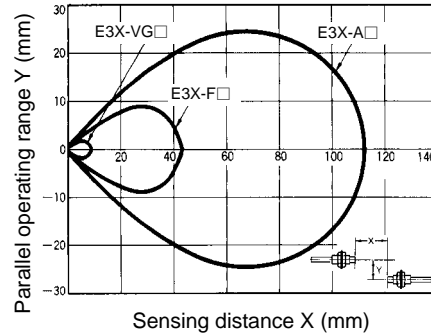

**Through-beam, Armored Type**

**E32-UTAT1-3F with E3JU-XR amplifier**

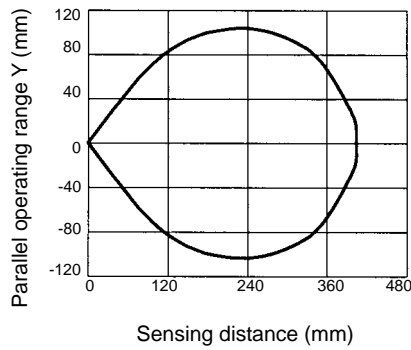

**E32-UTAT1-6F with E3JU-XR amplifier**

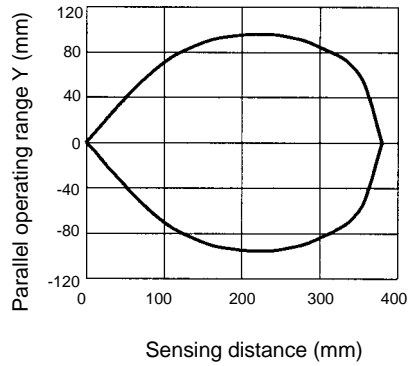

**E32-UTBT1-3F with E3JU-X amplifier**

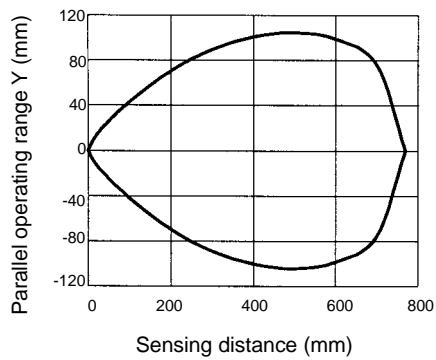

**E32-UTBT1-6F with E3JU-X amplifier**

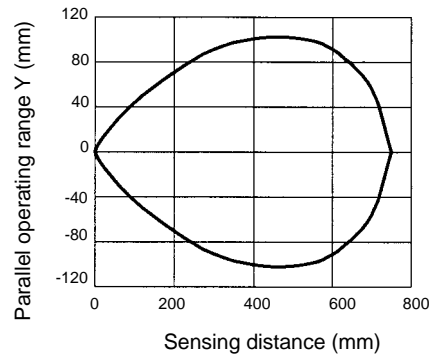

**OPERATING RANGE (CONT.)**

**Through-beam, Probe Type**

**E32-TC200B and E32-TC200B4 with E3X-A11 amplifier**

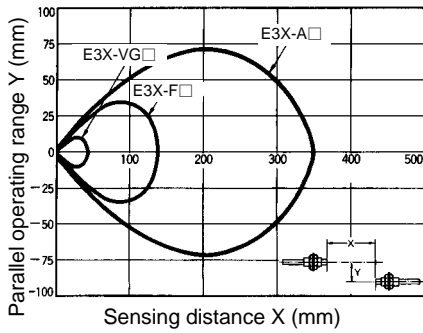

**E32-TC200D and E32-TC200D4 with E3X-A11 amplifier**

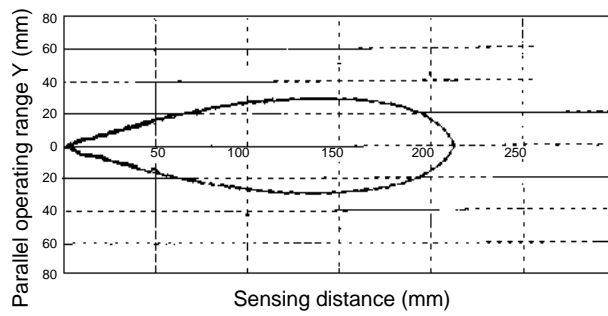

**E32-TC200F and E32-TC200F4 with E3X-A11 amplifier**

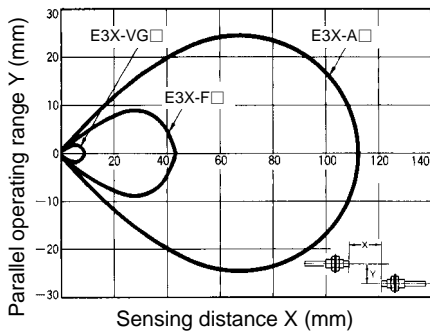

**Through-beam, Side Beam Type**

**E32-T14 with E3X-A11 amplifier**

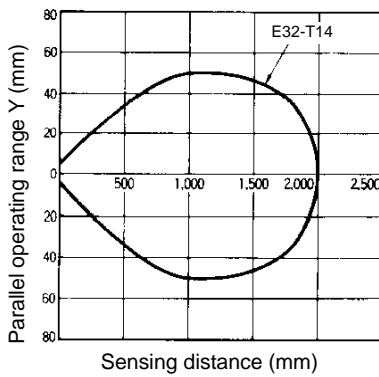

**E32-T14 with E3X-NH amplifier**

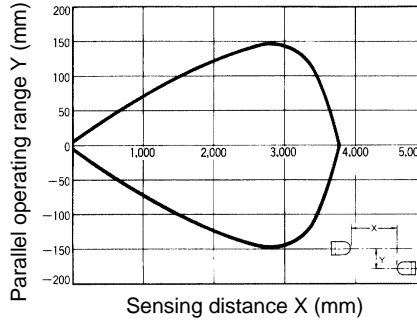

**E32-T14L with E3X-A11, E3X-F, and E3X-VG amplifiers**

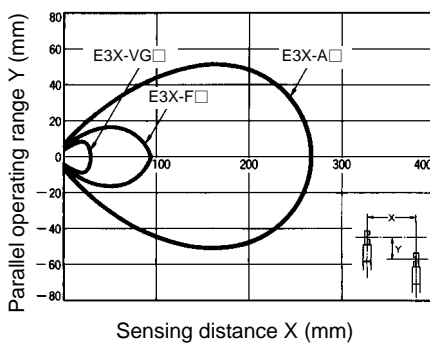

**E32-T14L with E3X-H11 amplifier**

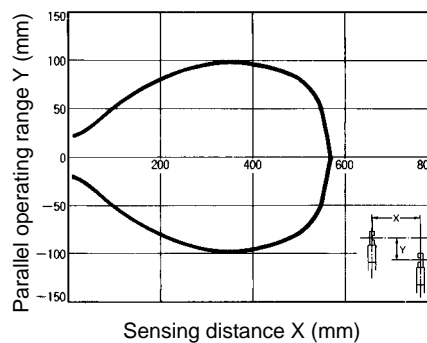

■ OPERATING RANGE (CONT.)

Through-beam, Side Beam Type

E32-T14L with E3X-NH amplifier

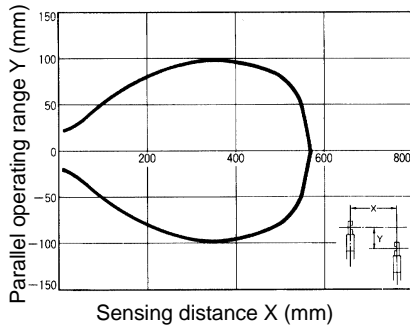

E32-T16 with E3X-A11 amplifier

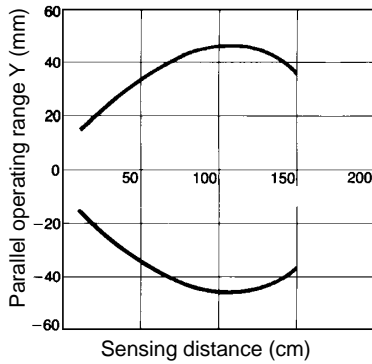

E32-T16 with E3XA-CC4A amplifier and 0.5 mm slit

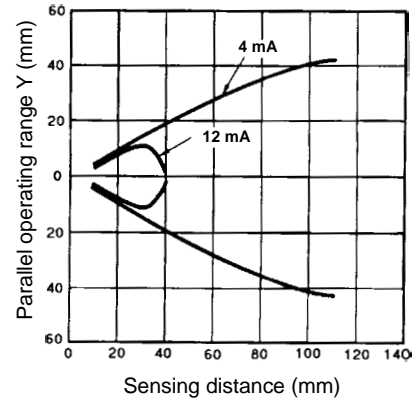

E32-T16 with E3XA-CC4A amplifier and 1 mm slit

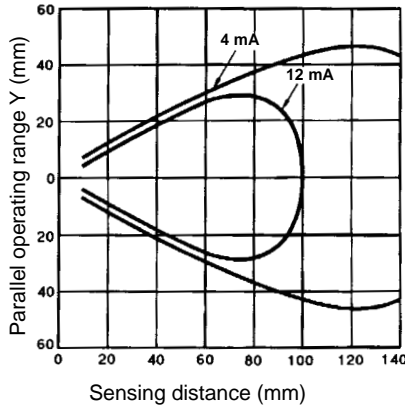

E32-T24 with E3X-A11 amplifier

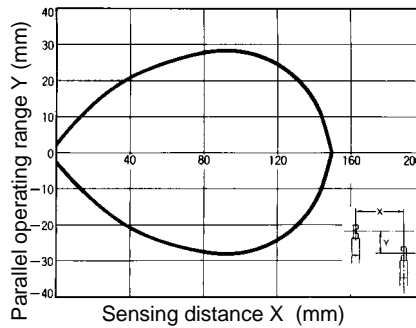

E32-T24 with E3X-NH amplifier

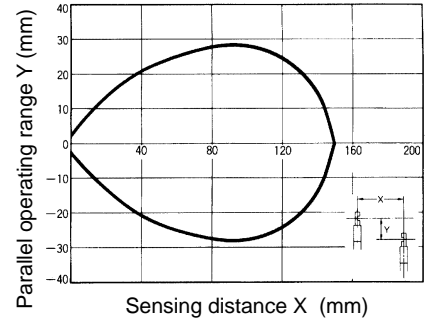

Through-beam, High Temperature Type

E32-T51 with E3X-A and E3X-F amplifiers

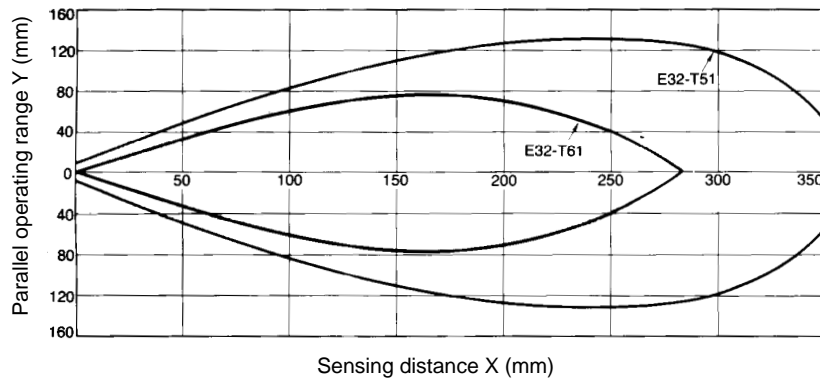

E32-T51 with E3X-NH amplifier

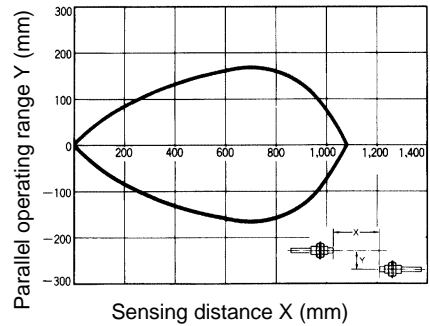

**OPERATING RANGE (CONT.)**

**Through-beam, High Temperature Type**

**E32-T51 with E3JU-XR amplifier**

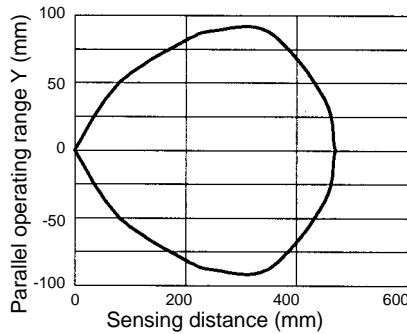

**E32-T61 with E3X-H11 amplifier**

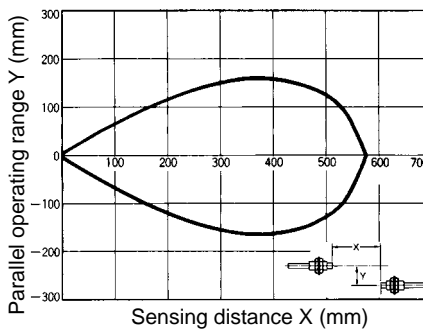

**E32-T61 with E3X-NH amplifier**

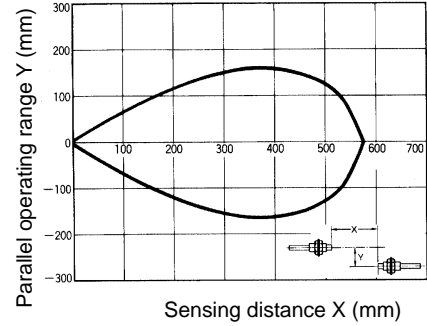

**Through-beam, Special Purpose Type**

**E32-M21 with E3X-A11 amplifier**

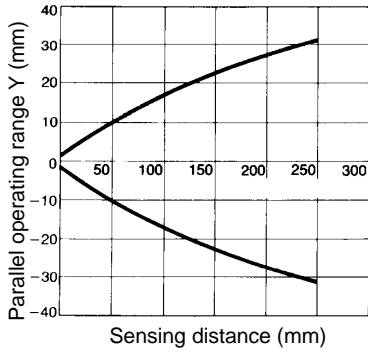

**E32-M21 with E3X-NH amplifier**

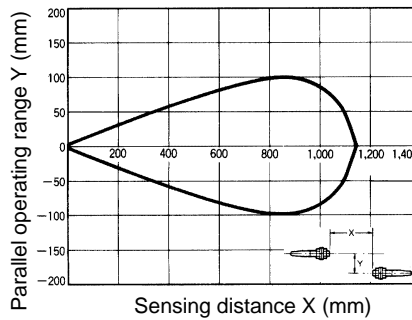

**E32-T12F with E3X-NH amplifier**

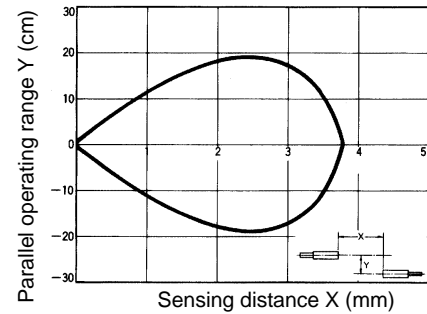

**E32-T12F with E3X-A, E3X-F, and E3X-VG amplifiers**

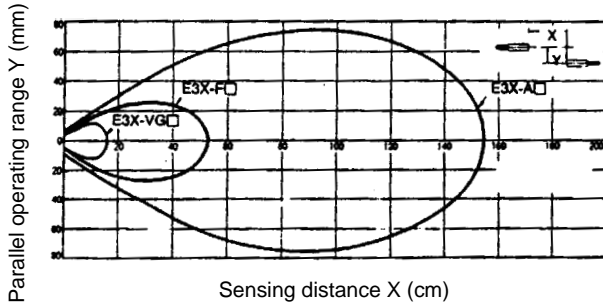

**E32-T12F with E3X-H11 amplifier**

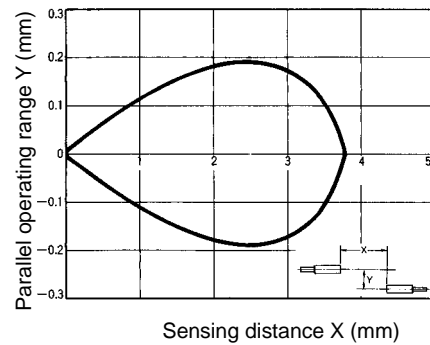

**E32-T22S with E3X-NH amplifier**

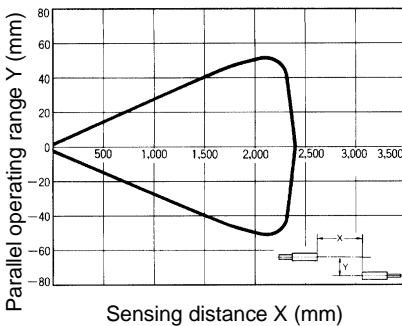

**E32-T24S with E3X-NH amplifier**

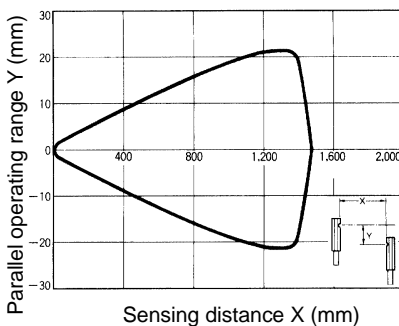

**E32-T84S with E3X-NH amplifier**

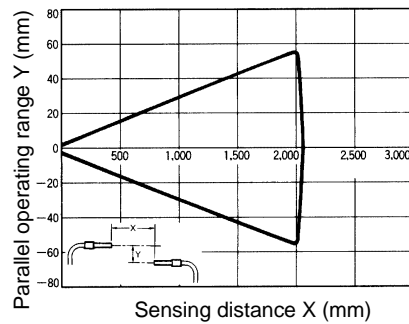

■ OPERATING RANGE (CONT.)

Diffuse, General Purpose Type

E32-CC200 with E3X-A and E3X-F amplifiers

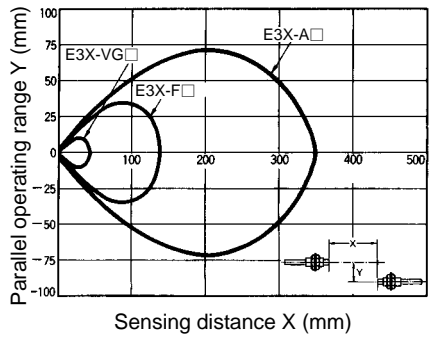

E32-CC200 with E3X-NH amplifier

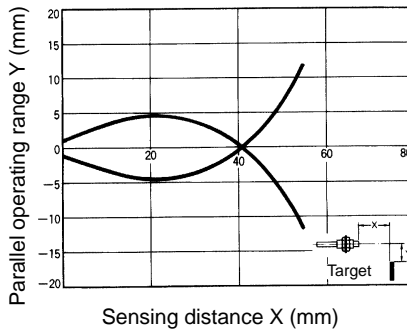

E32-CC200 with E3MC-Y amplifier

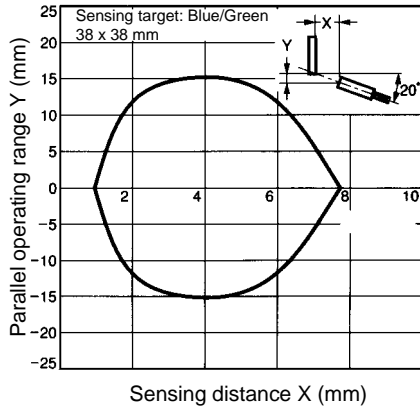

E32-D11 with E3X-NH amplifier

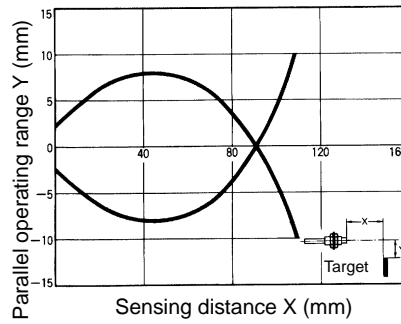

E32-D11 with E3JU-XR amplifier

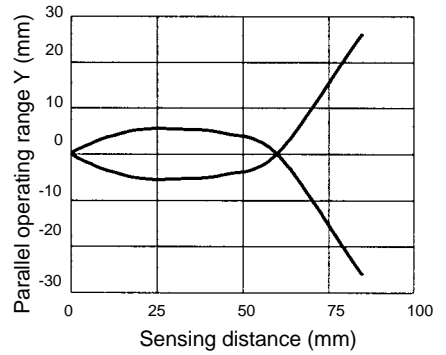

E32-D11L with E3X-A, E3X-F, and E3X-VG amplifiers

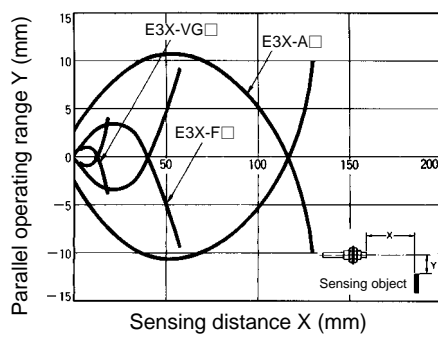

E32-D11L with E3X-H11 amplifier

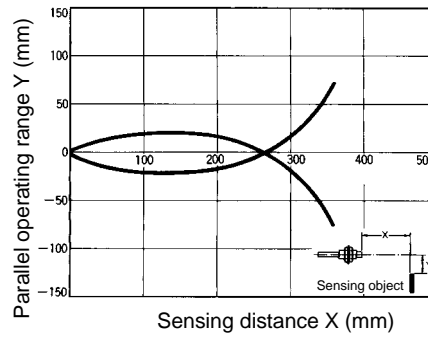

E32-D11L with E3X-NH amplifier

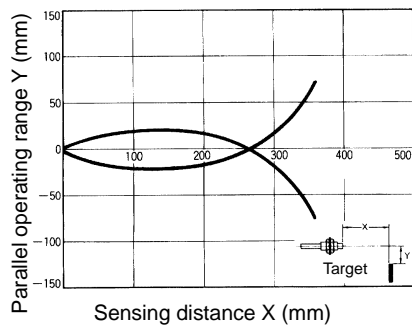

E32-D11L with E3X-NVG amplifier

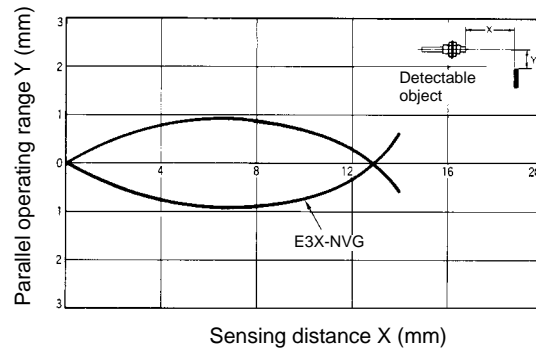

**OPERATING RANGE (CONT.)**

**Diffuse, General Purpose Type**

**E32-D11L with E3MC-Y amplifier**

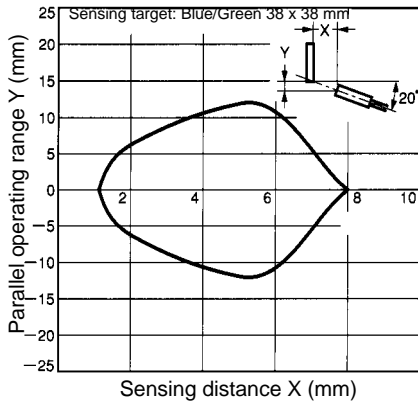

**E32-D11R with E3X-NH amplifier**

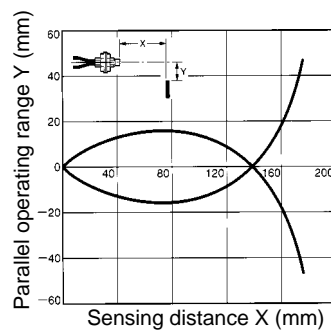

**E32-D21 with E3X-A, E3X-F and E3X-VG amplifiers**

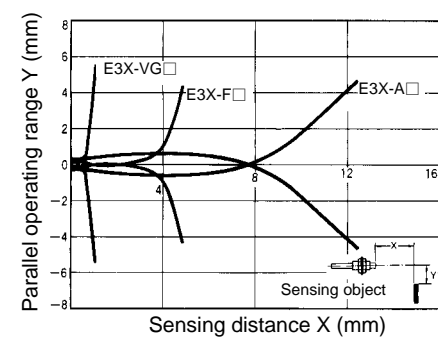

**E32-D21 with E3X-NH amplifier**

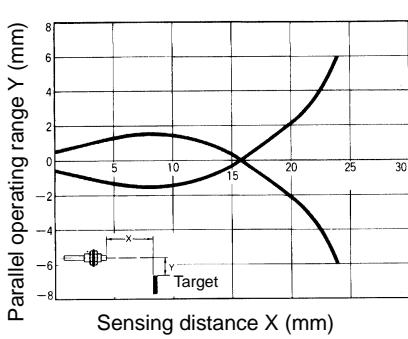

**E32-D21 with E3JU-XR amplifier**

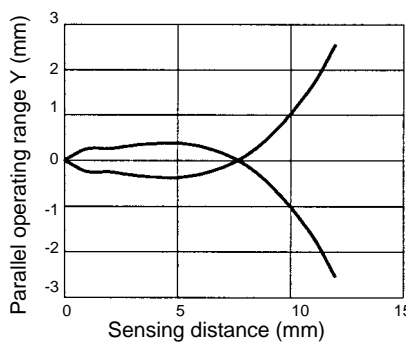

**E32-D21L with E3X-A and E3X-F amplifiers**

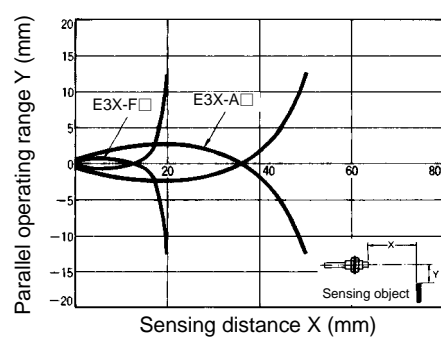

**E32-D21L with E3X-H11 amplifier**

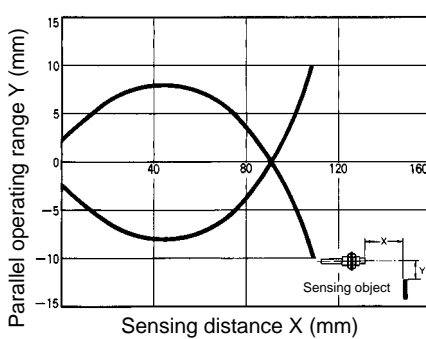

**E32-D21L with E3X-NH amplifier**

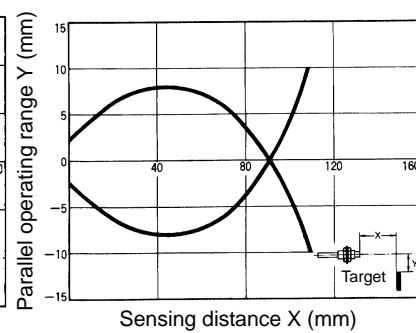

**E32-D21R with E3X-DA amplifier**

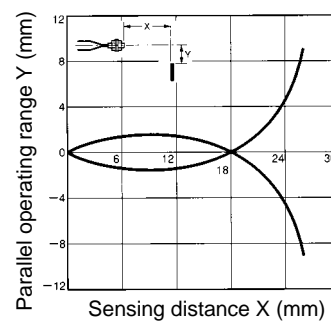

**E32-D22L with E3X-A and E3X-F amplifiers**

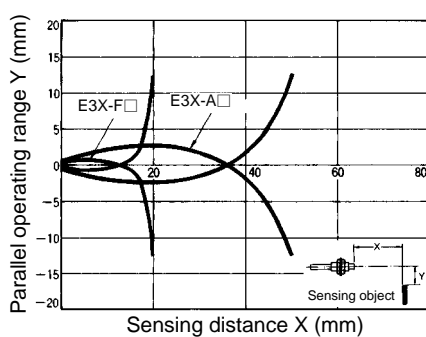

**E32-D32 with E3X-A11 amplifier**

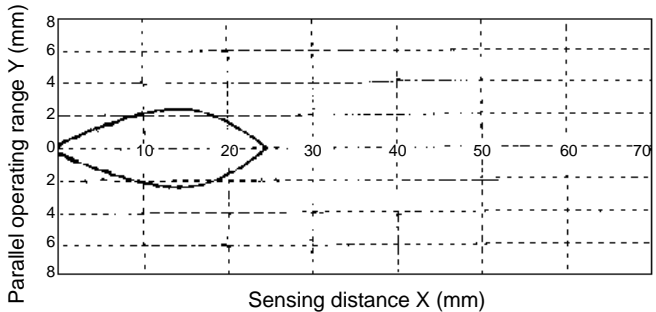

■ OPERATING RANGE (CONT.)

Diffuse, General Purpose Type

E32-D32 with E3X-NH amplifier

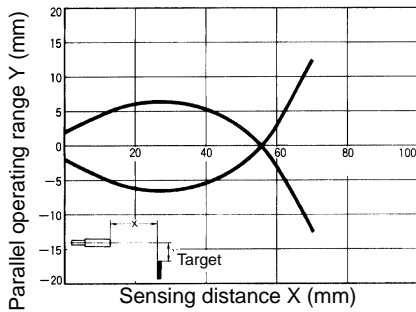

E32-D32 with E3JU-XR amplifier

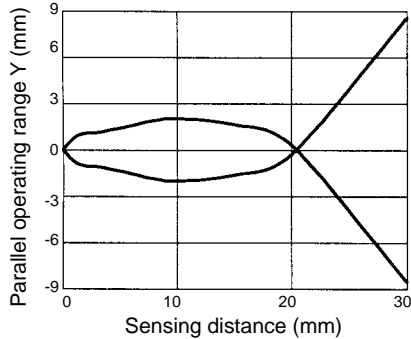

E32-D32L with E3X-A, E3X-F, and E3X-VG amplifiers

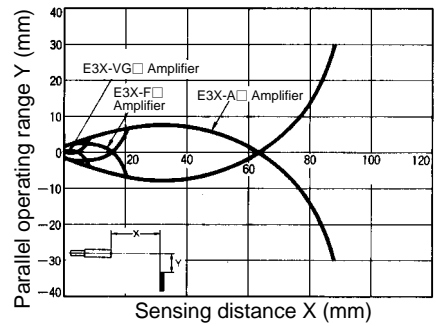

E32-D32L with E3X-NH amplifier

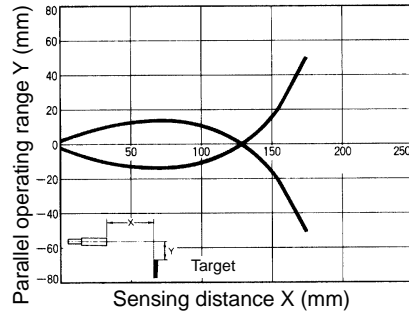

E32-D32L with E3MC-Y amplifier

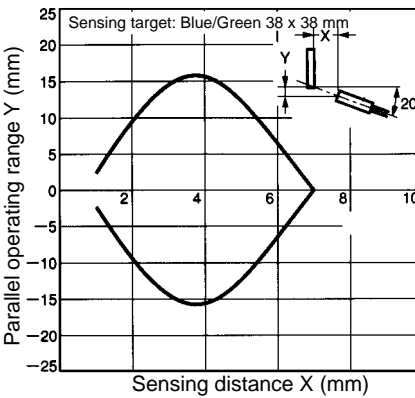

E32-DC50 with E3X-A, E3X-F, and E3X-VG amplifiers

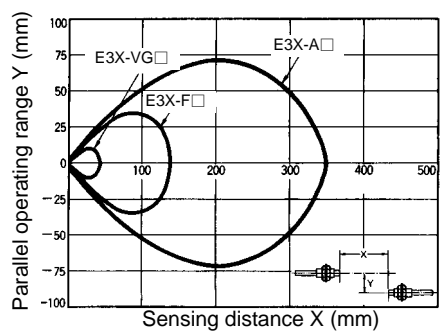

E32-DC200 with E3X-A, E3X-F, and E3X-VG amplifier

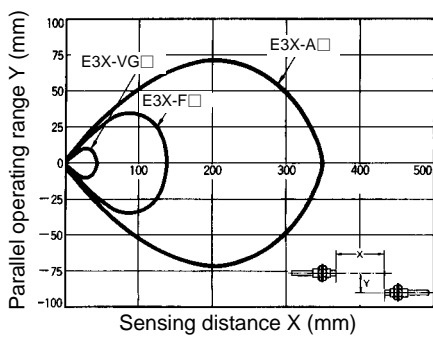

E32-DC200 with E3X-H11 amplifier

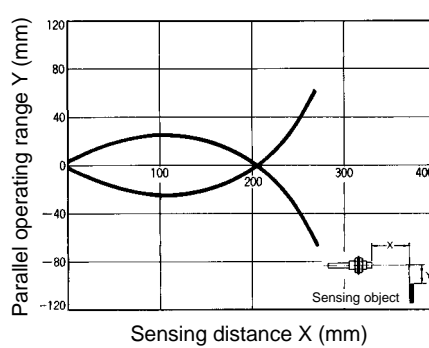

E32-DC200 with E3X-DA amplifier

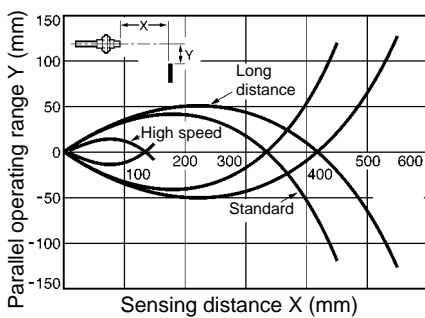

E32-DC200 with E3X-NH amplifier

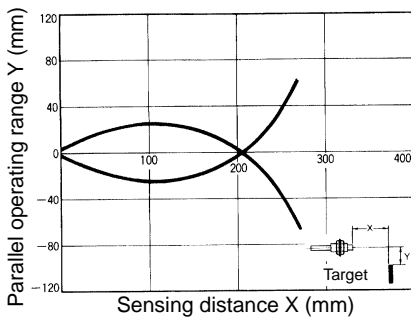

E32-DC200 with E3JU-XR amplifier

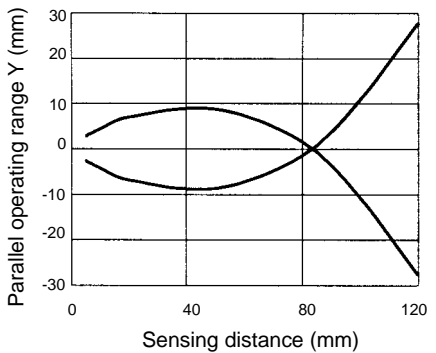

**OPERATING RANGE (CONT.)**

**Diffuse, General Purpose Type**

**E32-DC200 with E3X-NM and E3X-NT amplifiers**

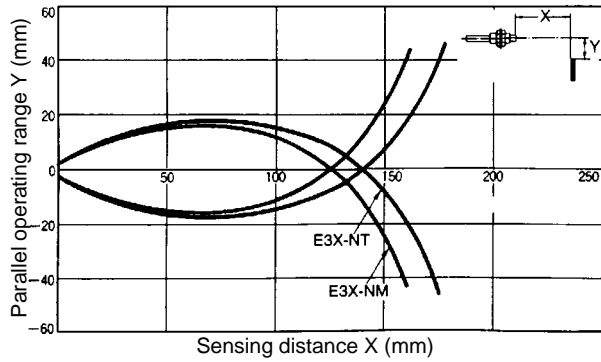

**E32-DC200 with E3X-NV amplifier**

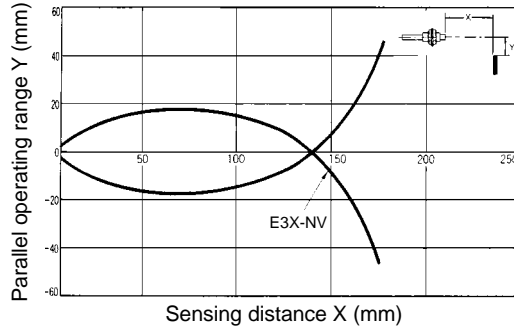

**E32-DC200 with E3MC-Y amplifier**

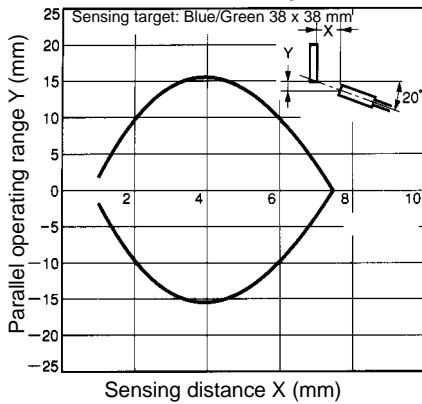

**E32-DC200C with E3X-A11 amplifier**

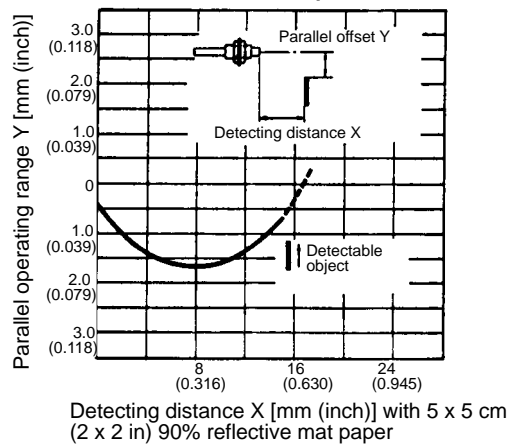

**E32-DC200E with E3X-A11 amplifier**

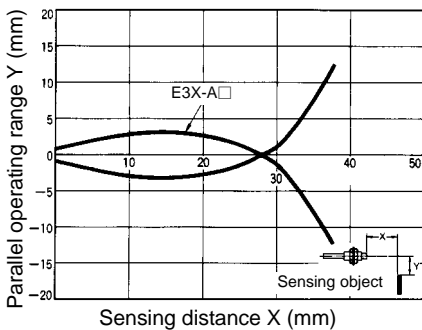

**Diffuse, Armored Type**

**E32-UDAT1-3F with E3JU-XR amplifier**

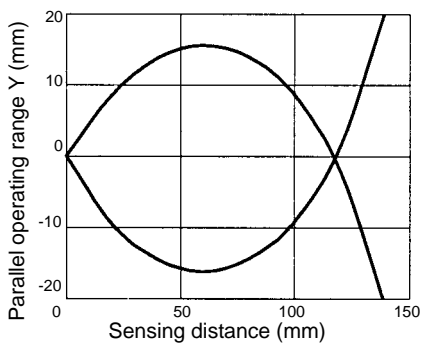

**E32-UDAT1-6F with E3JU-XR amplifier**

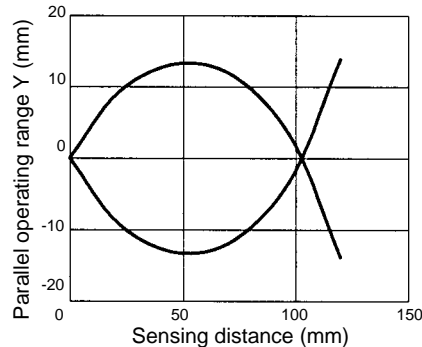



■ OPERATING RANGE (CONT.)

Diffuse, Armored Type

E32-UDAT1-3F and E32-UDAT1-6F with E3X-A11 amplifier

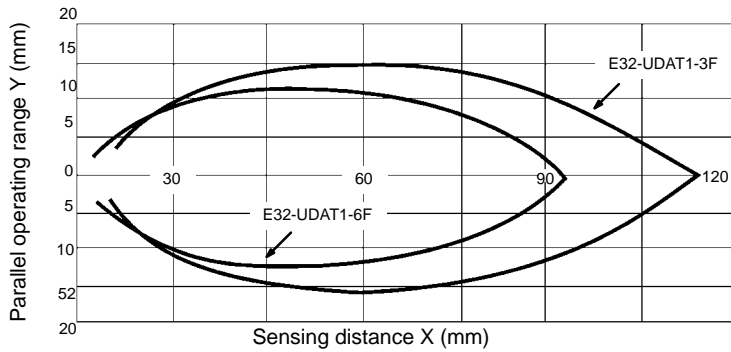

E32-UDBT1-3F with E3JU-X amplifier

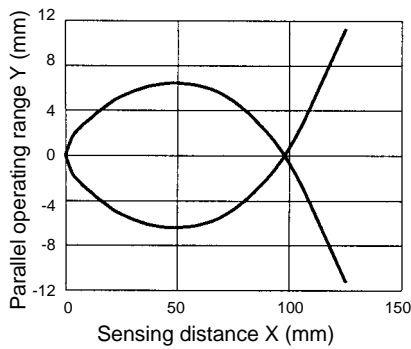

E32-UDBT1-6F with E3JU-X amplifier

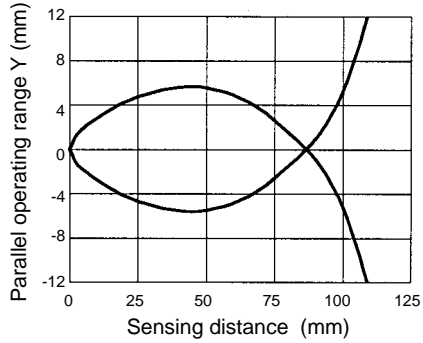

Diffuse, Probe Type

E32-D33 with E3X-A11 amplifier

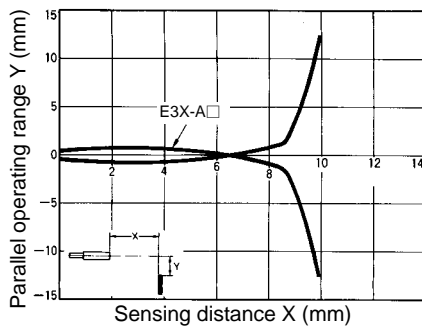

E32-D33 with E3X-DA amplifier

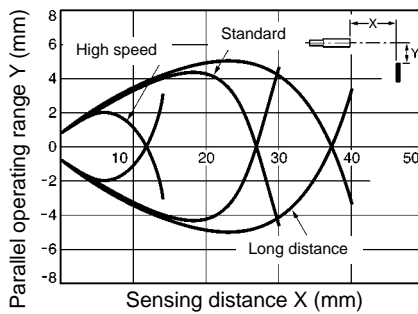

E32-D33 with E3X-NH amplifier

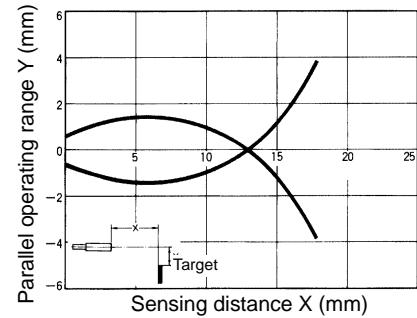

E32-DC200B and E32-DC200B4 with E3X-A and E3X-F amplifiers

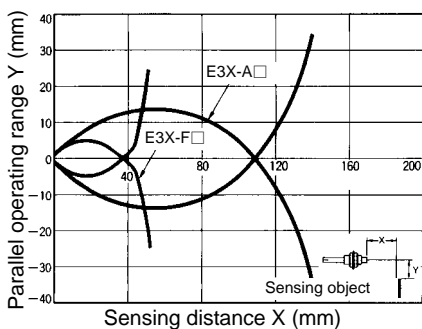

E32-DC200F with E3X-NH amplifier

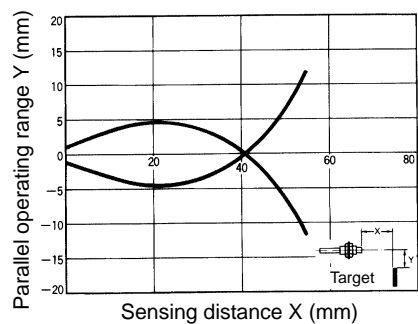

E32-DC200F and E32-DC200F4 with E3X-A11 amplifier

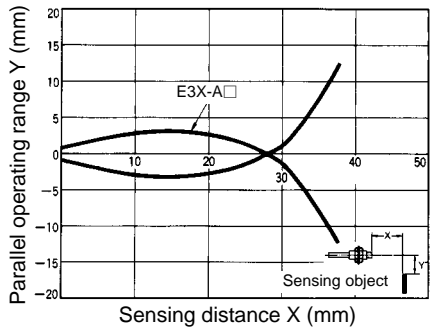

**OPERATING RANGE (CONT.)**

**Diffuse, Side Beam Type**

**E32-D14L with E3X-A, E3X-F and E3X-VG amplifiers**

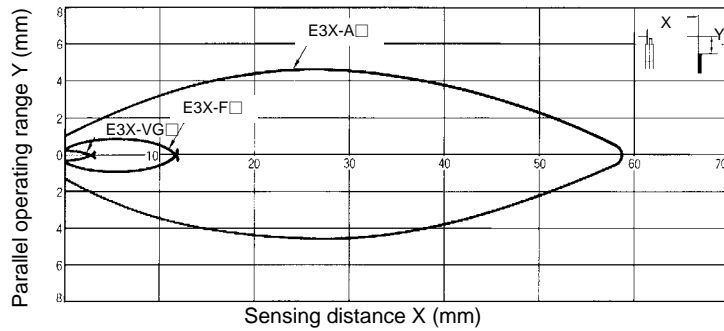

**E32-D24 with E3X-A and E3X-F amplifiers**

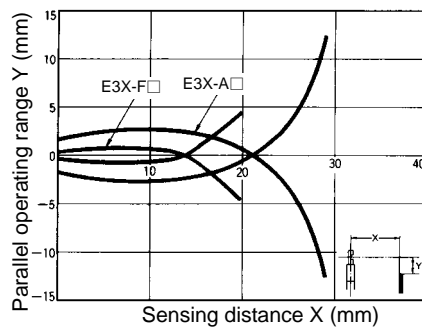

**Diffuse, High Temperature Type**

**E32-D51 with E3X-A and E3X-F amplifiers**

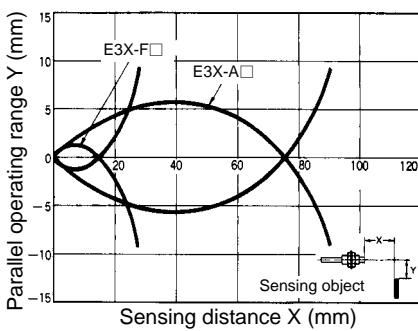

**E32-D51 with E3X-NH amplifier**

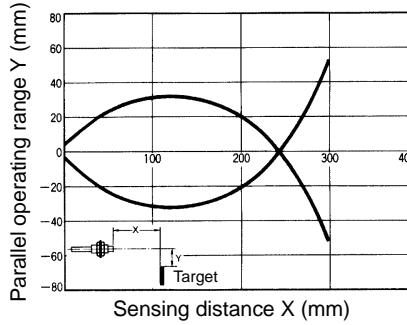

**E32-D51 with E3JU-XR amplifier**

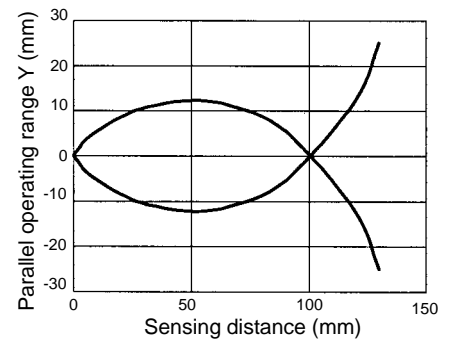

**E32-D61 with E3X-A and E3X-F amplifiers**

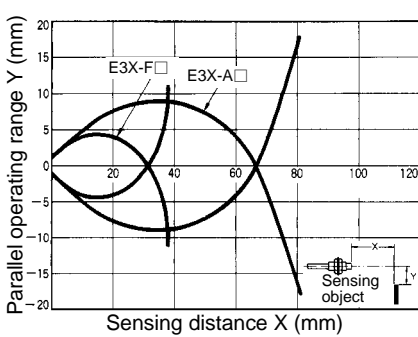

**E32-D73 with E3X-A and E3X-F amplifiers**

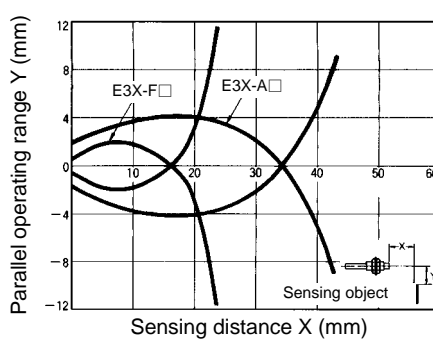

**OPERATING RANGE (CONT.)**

Diffuse, Convergent and Special Purpose Types

**E32-D12F with E3X-A, E3X-F and E3X-VG amplifiers**

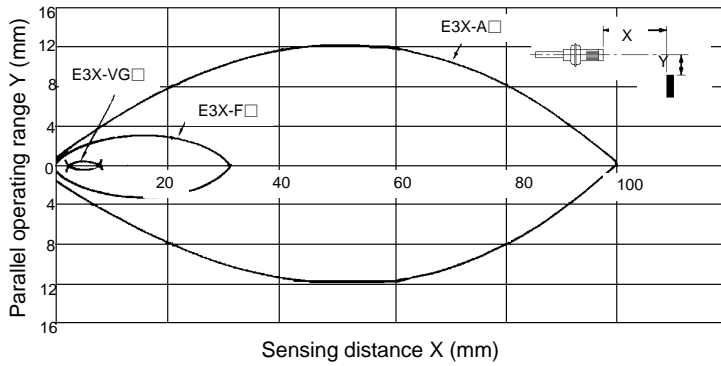

**E32-L25 and E32-L25A with E3X-A11 amplifier**

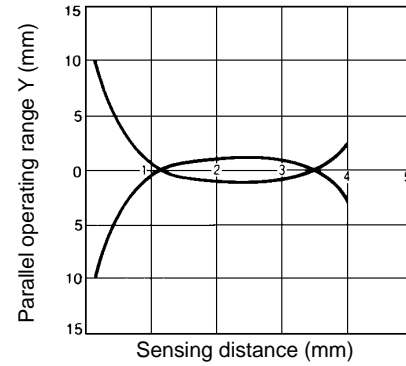

**E32-L25L with E3X-A amplifier**

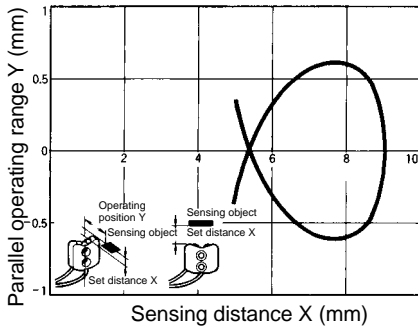

**E32-L25L with E3X-DA amplifier**

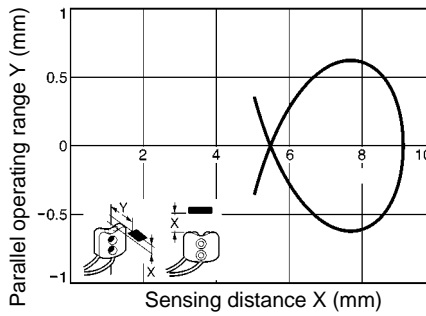

**E32-L25L with E3X-NH amplifier**

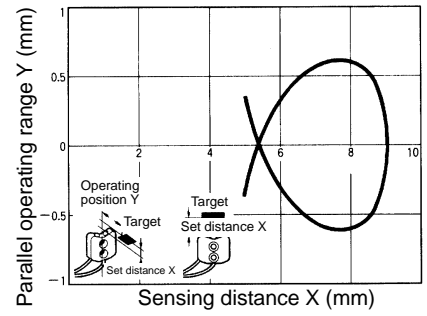

**Retroreflective Type**

**E32-R21 with E3X-A11 amplifiers**

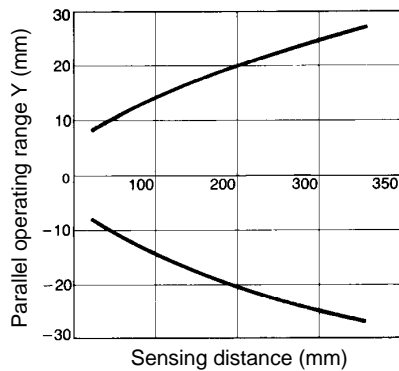

**E32-R21 with E3XA-CC4A amplifier and E39-R3 reflector**

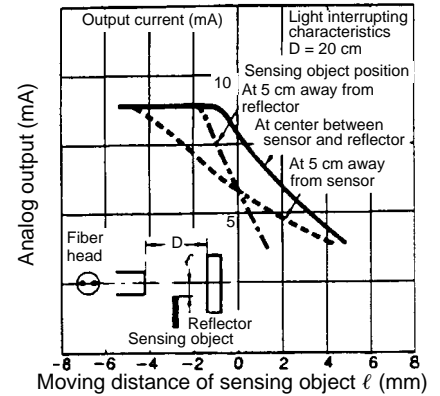
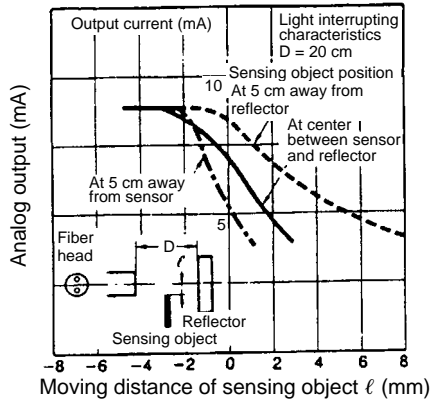

# Dimensions

Unit: mm (inch)

## THROUGH-BEAM TYPE

(Sold in pairs)

### General Purpose

#### E32-T11

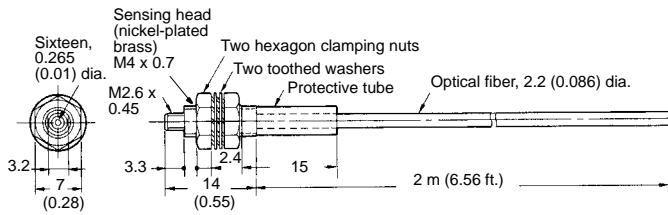

#### E32-T11L

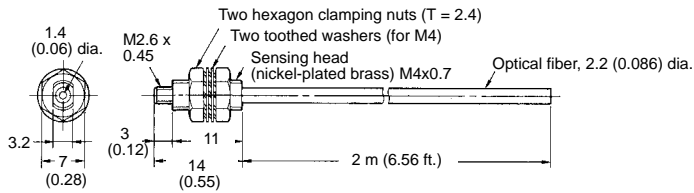

#### E32-T11R

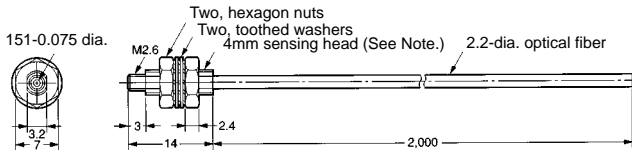

Note: The sensing head is made of nickel-plated brass.

#### E32-T12L

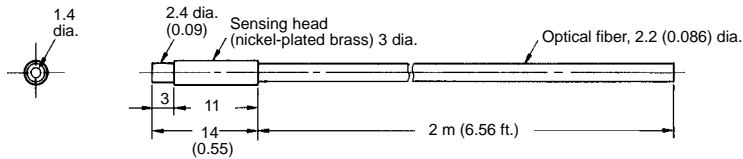

#### E32-T17L

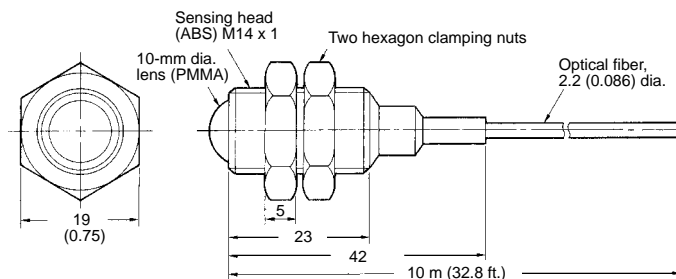

## ■ THROUGH-BEAM TYPE (CONT.)

### E32-T21

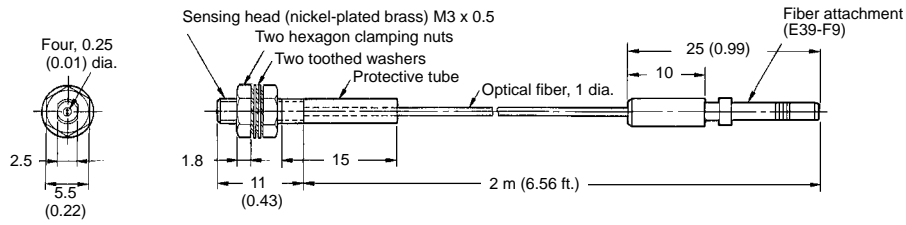

### E32-T21L

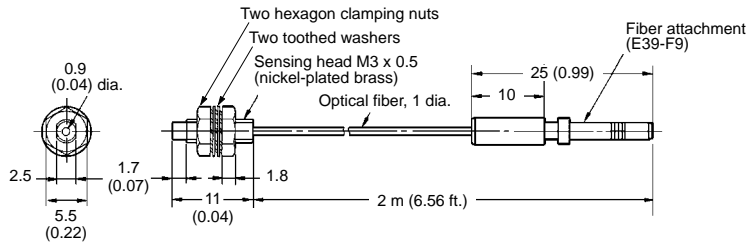

### E32-T21R

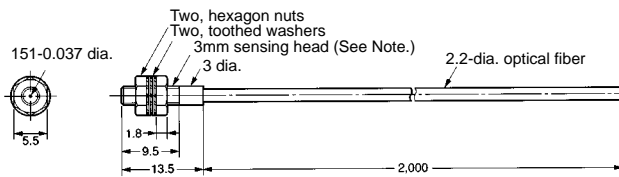

Note: The sensing head is made of nickel-plated brass.

### E32-T22

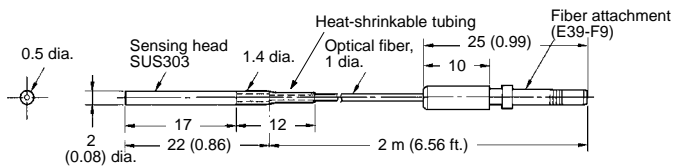

### E32-T22L

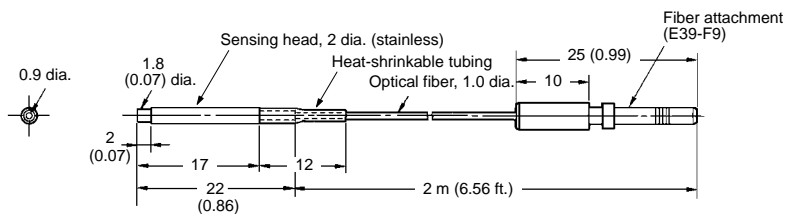

■ THROUGH-BEAM TYPE (CONT.)

E32-TC50, E32-TC200, E32-TC500,  
E32-TC1000

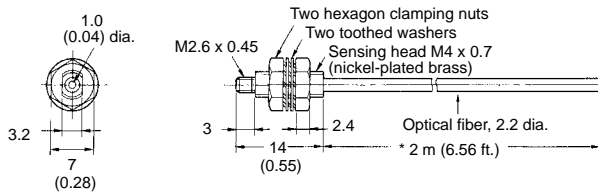

\* This length is 50 cm for E32-TC50, 5 m for E32-TC500 and 10 m for E32-TC10000.

E32-TC200A

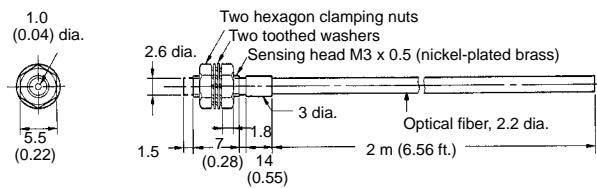

E32-TC200C

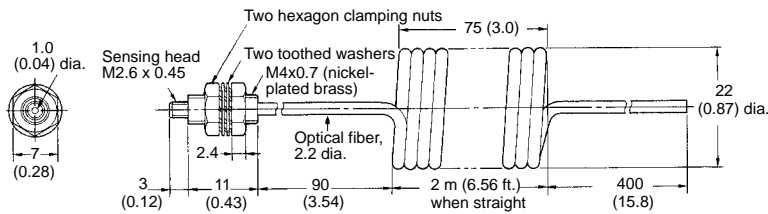

E32-TC200E

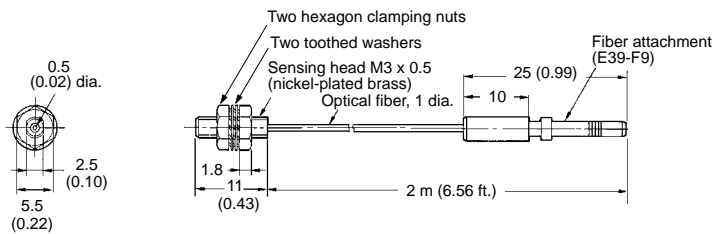

Armored Type

E32-UTAT1-3F  
E32-UTAT1-6F

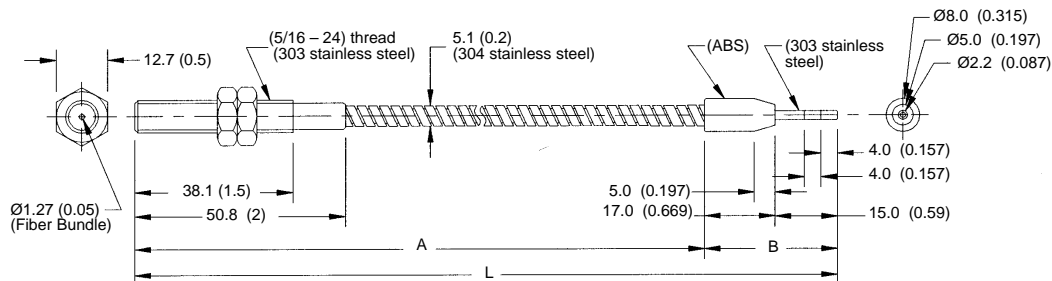

Note: 1. Distance A can withstand 150°C (302°F); Distance B can withstand 70°C (158°F);  
2. L = 3ft. for E32-UTAT1-3F; 6ft. for E32-UTAT1-6F

■ THROUGH-BEAM TYPE (CONT.)

E32-UTBT1-3F  
E32-UTBT1-6F

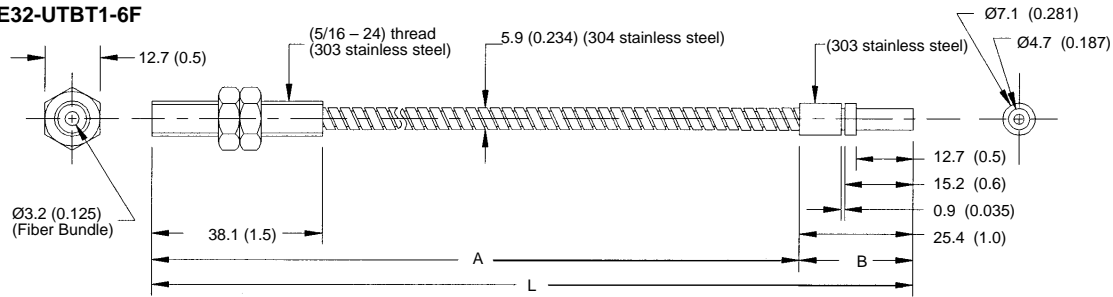

- Note: 1. Distance A can withstand 200°C (392°F); Distance B can withstand 70°C (158°F);  
2. L = 3ft. for E32-UTAT1-3F; 6ft. for E32-UTAT1-6F

Probe Type

E32-T33-1

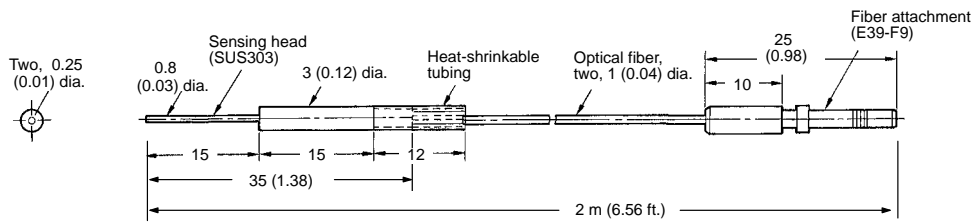

E32-TC200B  
E32-TC200B4

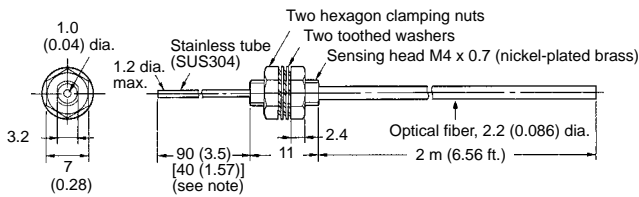

Note: The values in the brackets are for the E32-TC200B4.

E32-TC200D  
E32-TC200D4

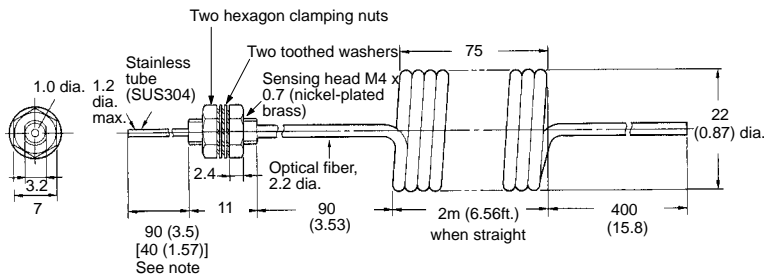

Note: The values in the brackets are for the E32-TC200D4.

■ THROUGH-BEAM TYPE (CONT.)

E32-TC200F  
E32-TC200F4

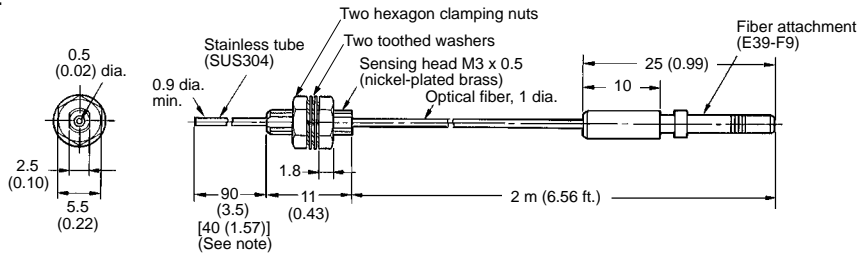

Note: The values in the brackets are for the E32-TC200F4.

Side Sensing Type

E32-T14

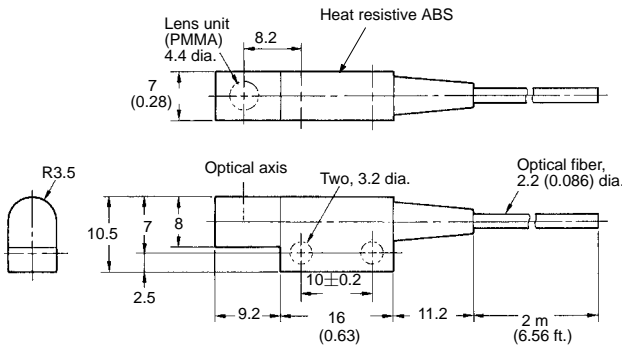

E32-T14L

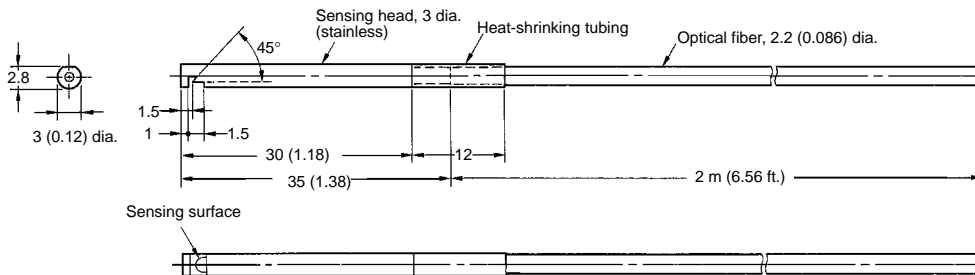



■ THROUGH-BEAM TYPE (CONT.)

Side Sensing Type

E32-T16

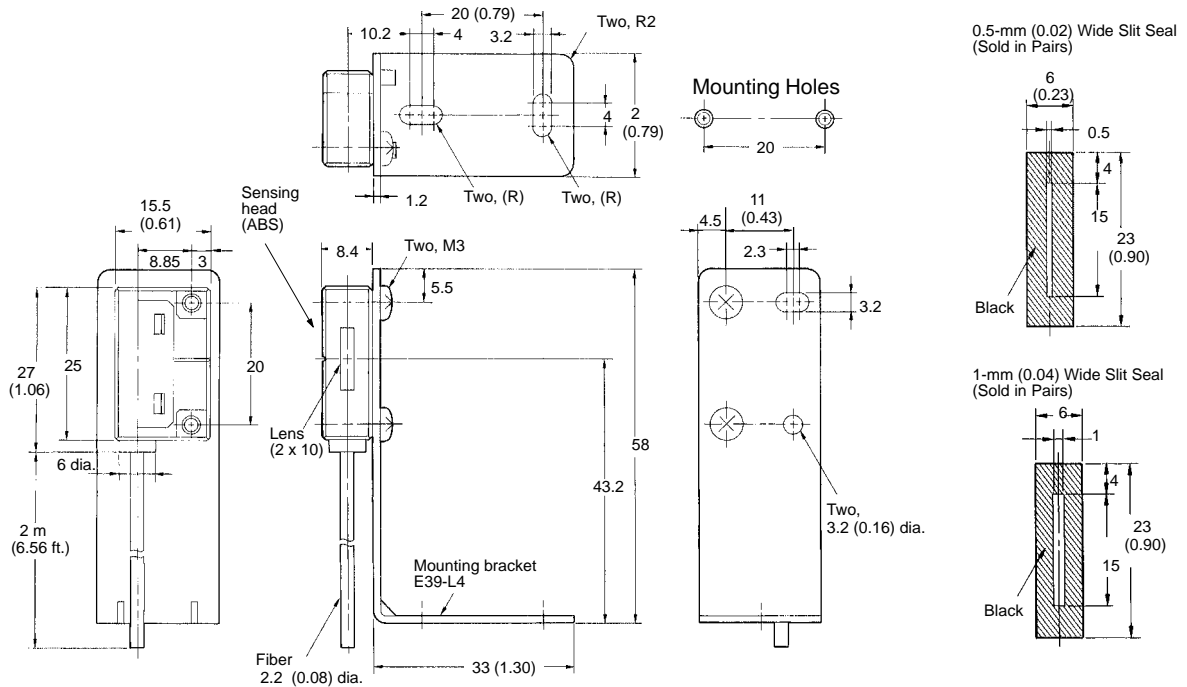

E32-T16P

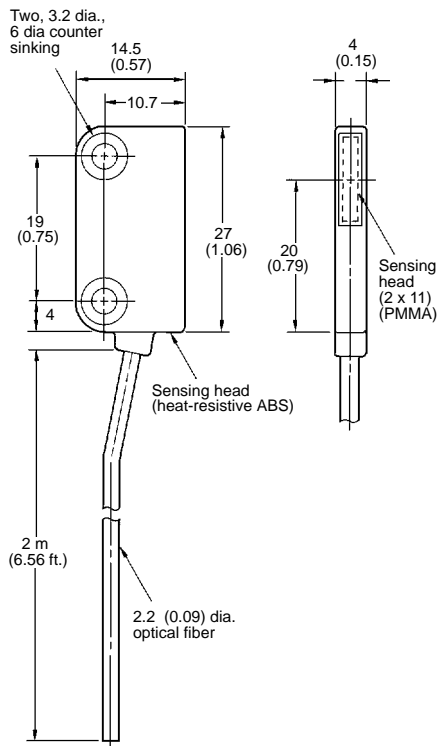

0.5-mm (0.02) wide Seal Slit  
(Two slits are provided)

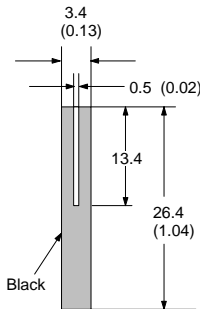

1-mm (0.04) wide Seal Slit  
(Two slits are provided)

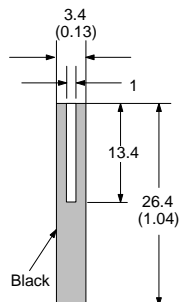

E32-T16P + E39-L94 Mounting

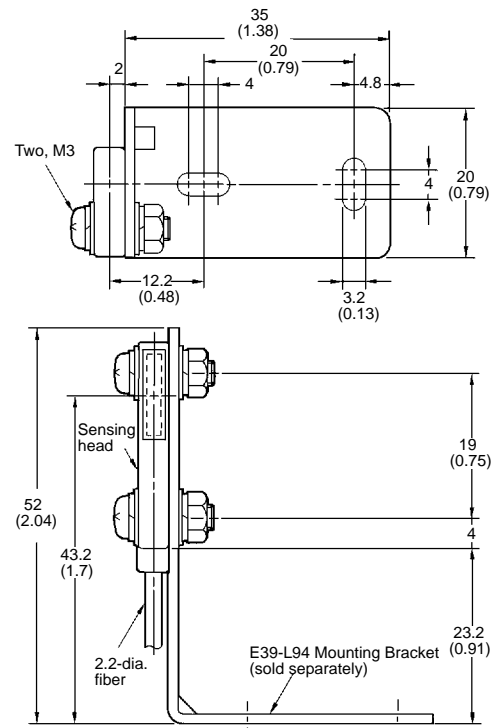

■ THROUGH-BEAM TYPE (CONT.)

Side Sensing Type

E32-T24

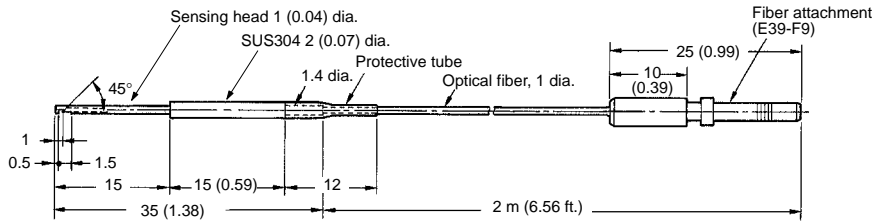

High Temperature Type

E32-T51

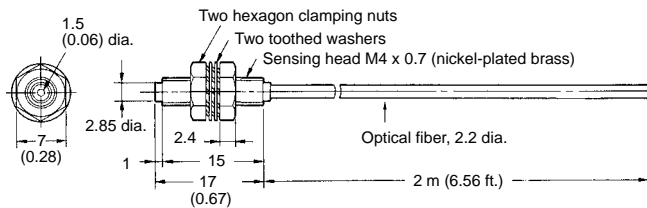

Note: Resistant temperature is 150°C (302°F). Resistant temperature is 130°C (266°F) when used continuously.

E32-T61

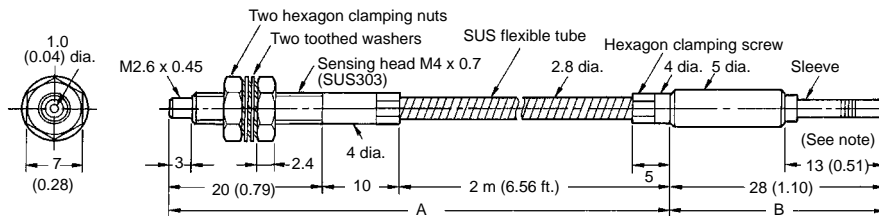

Note: Section A resists 300°C and section B (which is inserted to the amplifier) resists 110°C. The operating temperature of section B must also be within the withstand temperature range of the amplifier.

Special Purpose

E32-G14

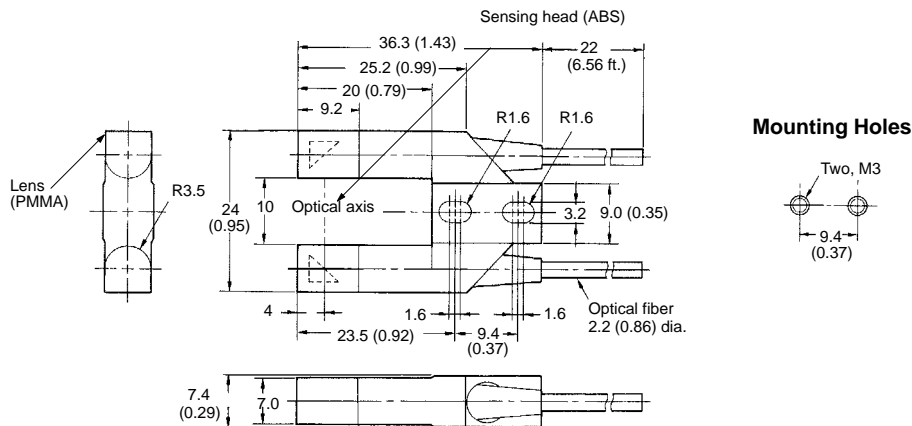

■ THROUGH-BEAM TYPE (CONT.)

Special Purpose

E32-M21

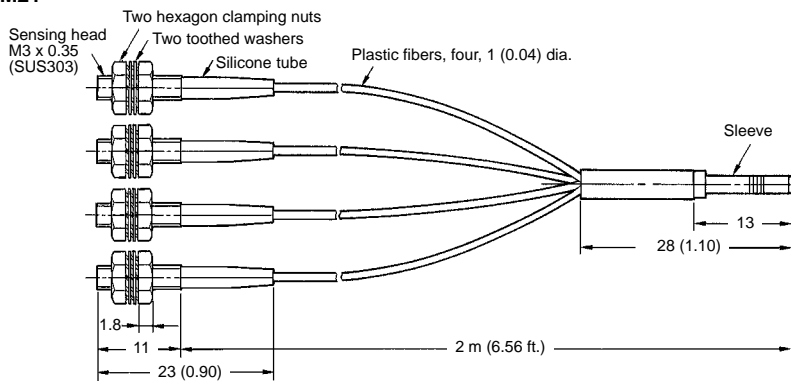

Note: One set of silicone tubes is black while the other set is gray for easy identification when they are connected to the light source and receiver.

E32-T12F

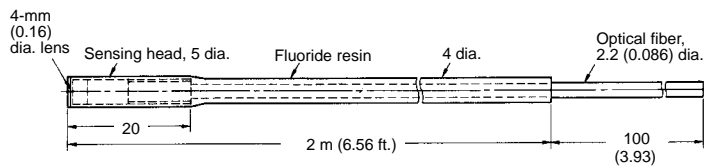

E32-T22S

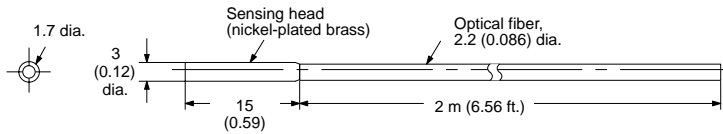

E32-T24S

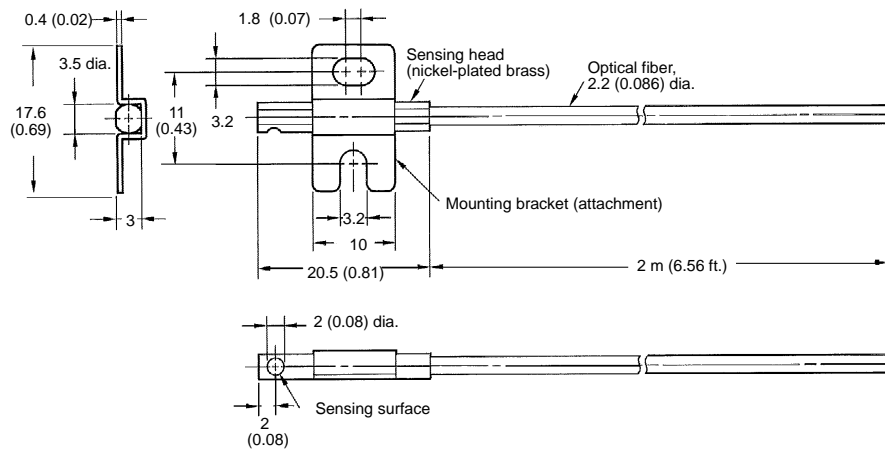

THROUGH-BEAM TYPE (CONT.)

Special Purpose

E32-T84S

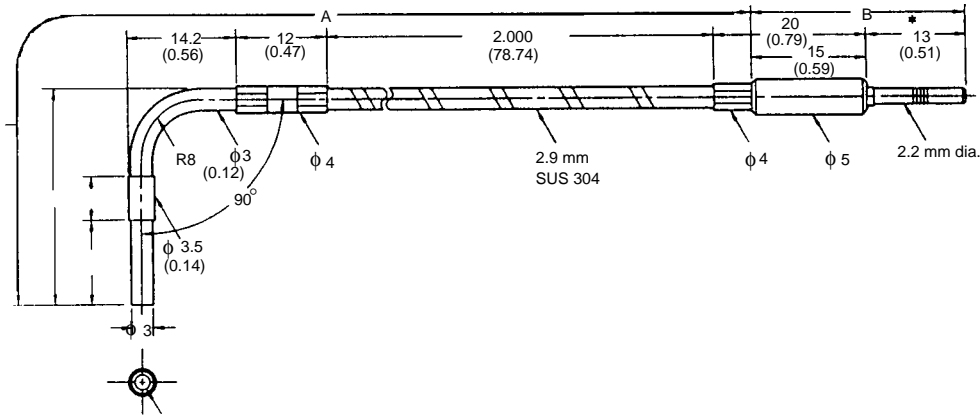

DIFFUSE TYPE

General Purpose

E32-CC200

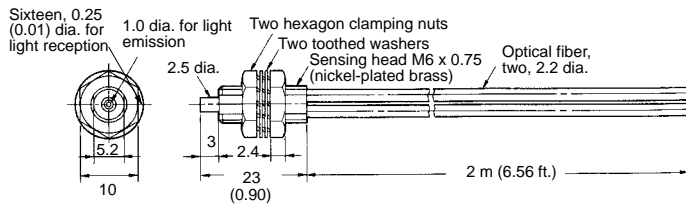

E32-D11

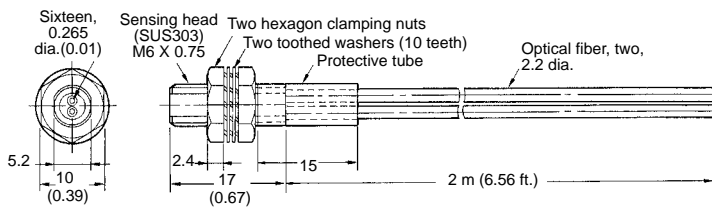

E32-D11L

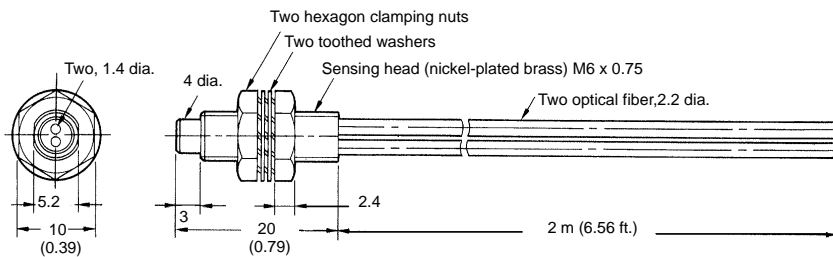

■ DIFFUSE TYPE (CONT.)

General Purpose

E32-D11R

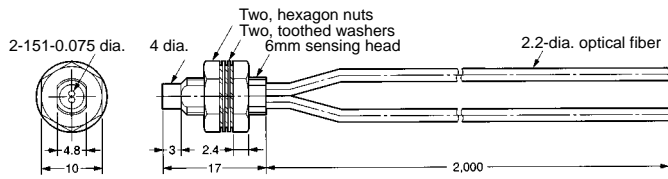

Note: The material is ADC (aluminum die-cast)

E32-D21

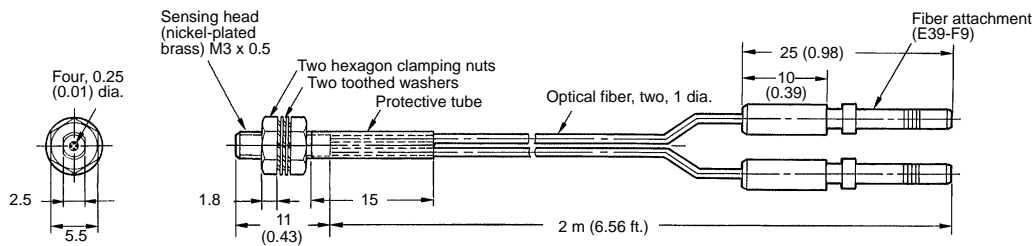

E32-D21L

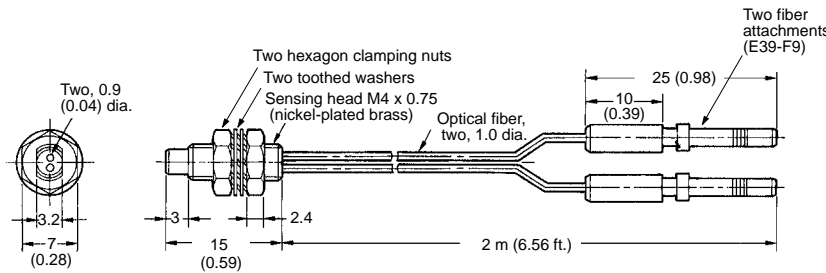

E32-D21R

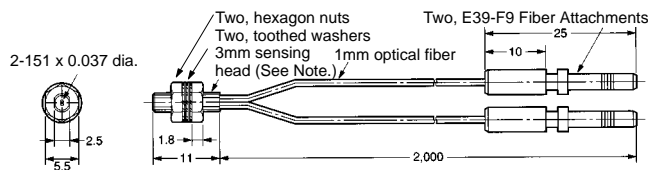

Note: The sensing head is made of nickel-plated brass.

E32-D22L

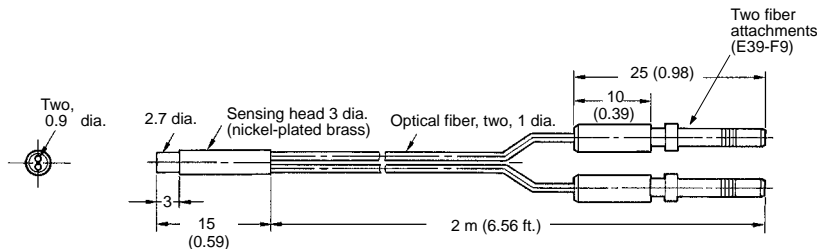

■ DIFFUSE TYPE (CONT.)

General Purpose

E32-D32

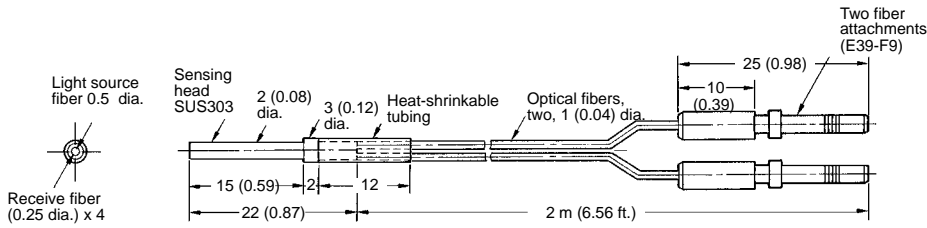

E32-D32L

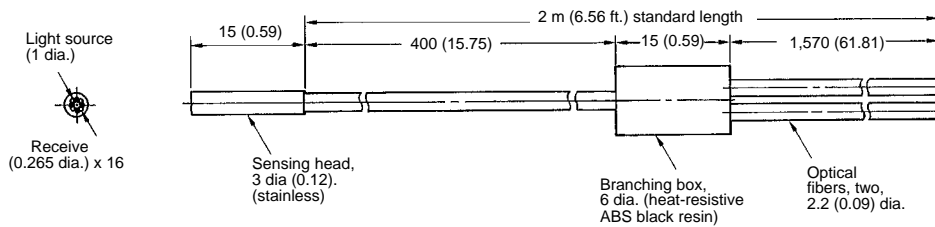

E32-DC50, E32-DC200,  
E32-DC500, E32-DC1000

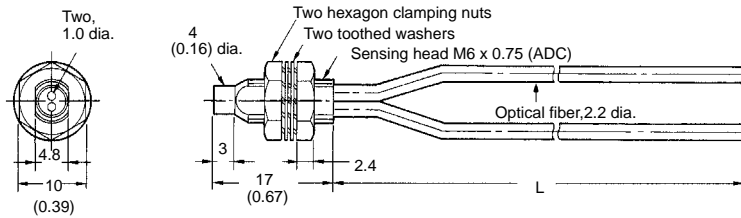

Part number	L
E32-DC50	50 cm (19 in)
E32-DC200	2 m (6.56 ft.)
E32-DC500	5 m (16.3 ft.)
E32-DC1000	10 m (32.8 ft.)

E32-DC200C

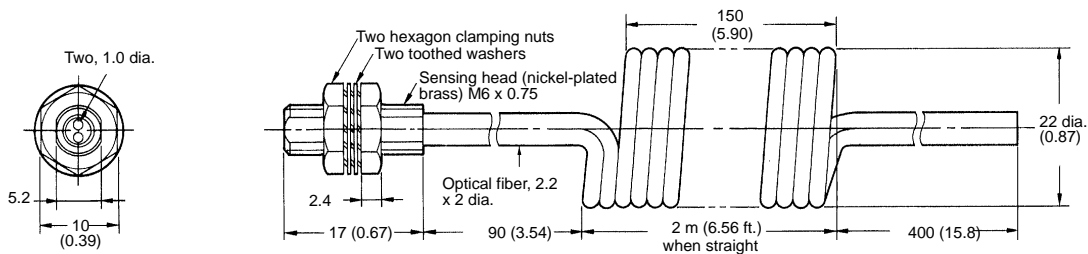

E32-DC200E

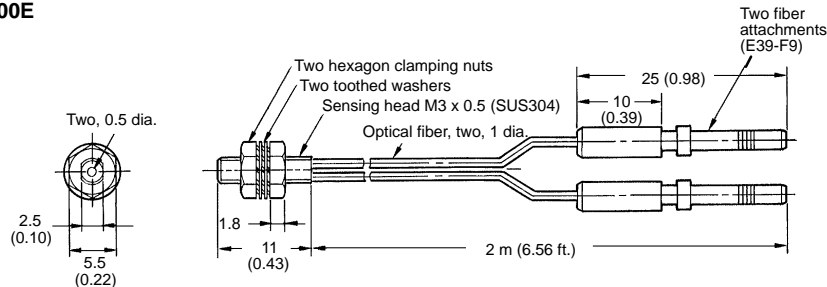

■ DIFFUSE TYPE (CONT.)

Armored Type

E32-UDAT1-3F  
E32-UDAT1-6F

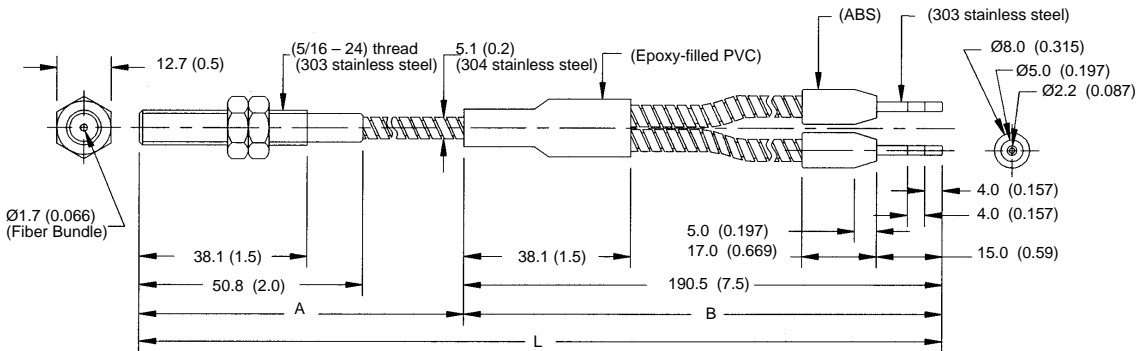

Note: 1. Distance A can withstand 150°C (302°F); Distance B can withstand 70°C (158°F); L= 3ft. or 6ft.  
2. L = 3ft. for E32-UDAT1-3F; 6ft. for E32-UDAT1-6F

E32-UDBT1-3F  
E32-UDBT1-6F

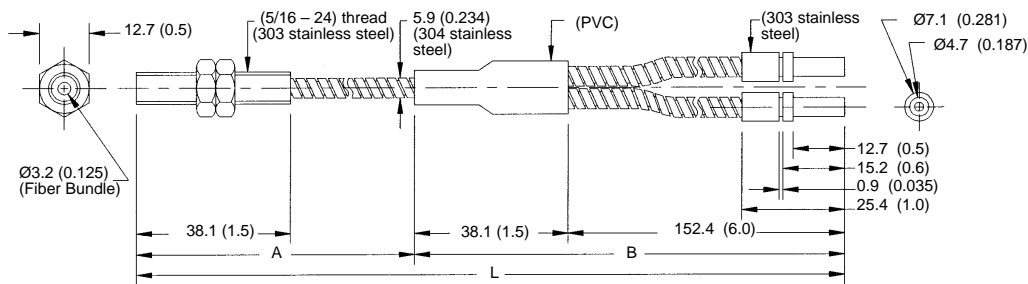

Note: 1. Distance A can withstand 200°C (392°F); Distance B can withstand 70°C (158°F)  
2. L = 3ft. for E32-UDBT1-3F; 6ft. for E32-UDBT1-6F

Probe Type

E32-D33

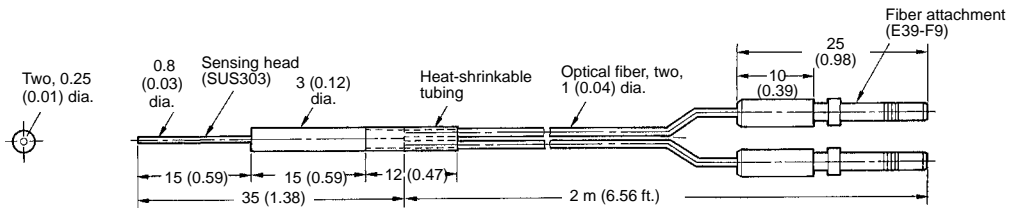

E32-DC200B  
E32-DC200B4

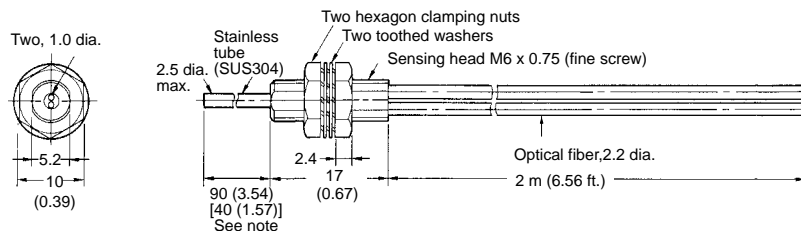

Note: The values in the brackets are for the E32-DC200B4.

■ DIFFUSE TYPE (CONT.)

Probe Type

E32-DC200D  
E32-DC200D4

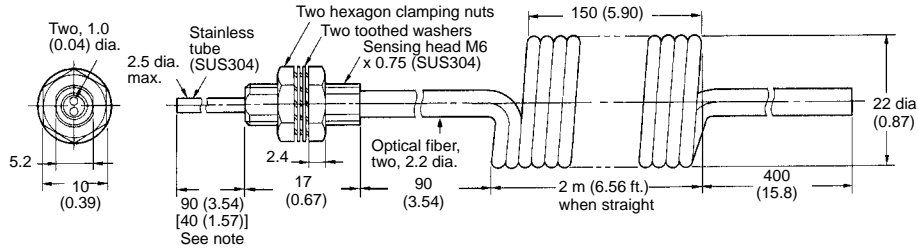

Note: The values in the brackets are for the E32-DC200D4.

E32-DC200F  
E32-DC200F4

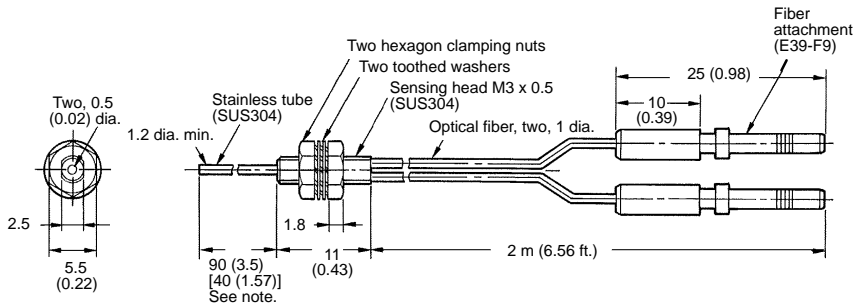

Note: The values in the brackets are for the E32-TC200F4.

E32-DC9G  
E32-DC9G4

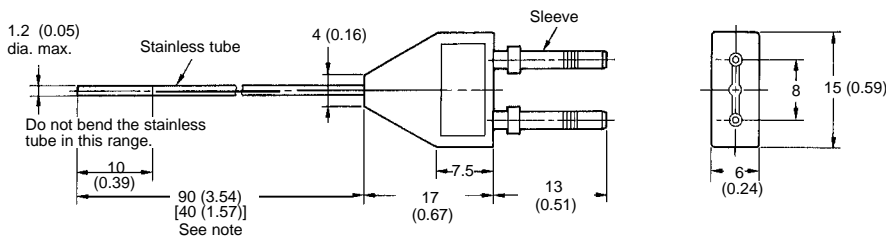

Note: The values in the brackets are for the E32-DC9G4.

Side Sensing Type

E32-D14L

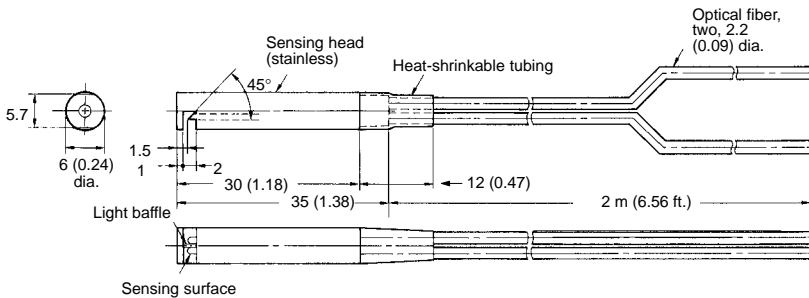



■ DIFFUSE TYPE (CONT.)

Side Sensing Type

E32-D24

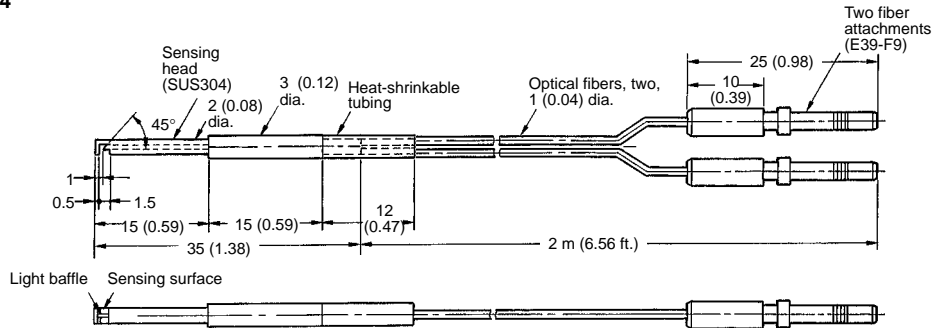

High Temperature Type

E32-D51

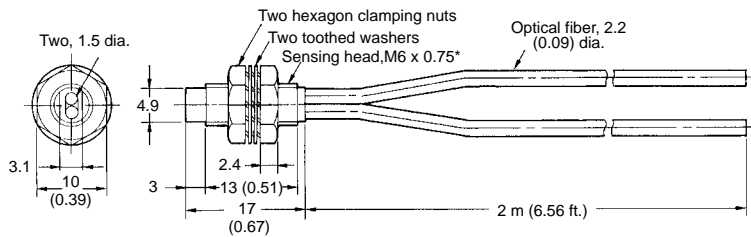

\*nickel-plated brass

Note: Resistant temperature is 150°C (302°F). Resistant temperature is 130°C (266°F) when used continuously.

E32-D61

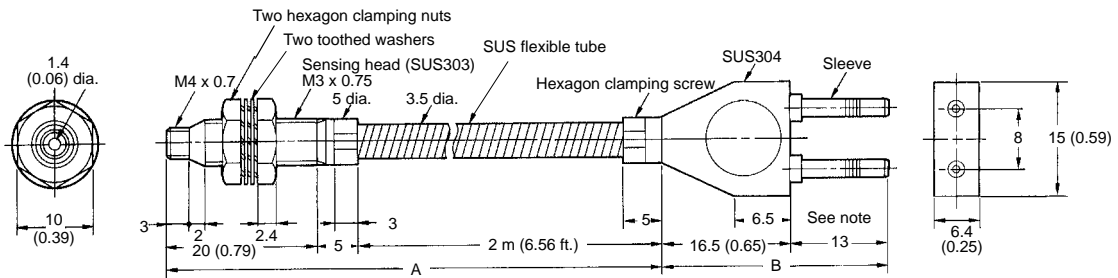

Note: Section A resists 300°C (572°F) and section B (which is inserted to the amplifier) resists 110°C (230°F). The operating temperature of section B must also be within the withstand temperature range of the amplifier.

■ DIFFUSE TYPE (CONT.)

High Temperature Type

E32-D73

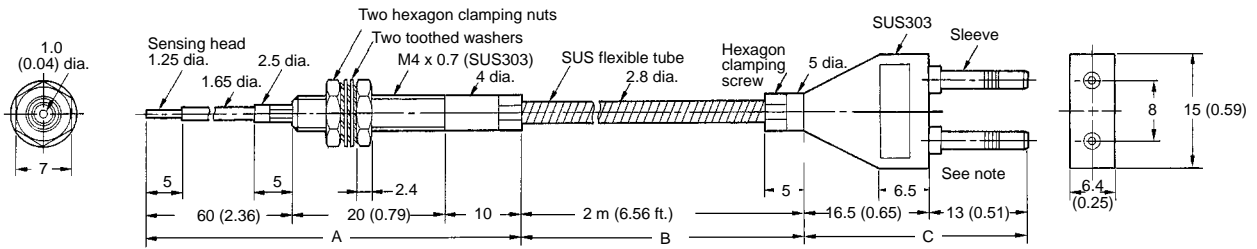

Note: Section A resists 400°C (752°F), section B resists 300°C (572°F) and section C (which is inserted to the amplifier) resists 110°C (230°F). The operating temperature of section C must also be within the withstand temperature range of the amplifier.

Convergent Type and Special Purpose

E32-D12F

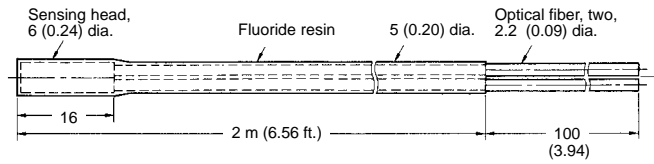

E32-L24L

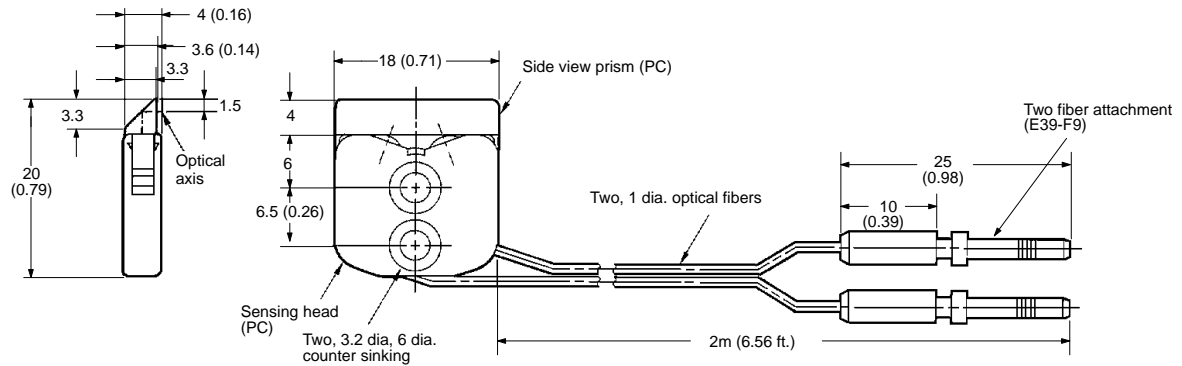

■ DIFFUSE TYPE (CONT.)

Convergent Type

E32-L25

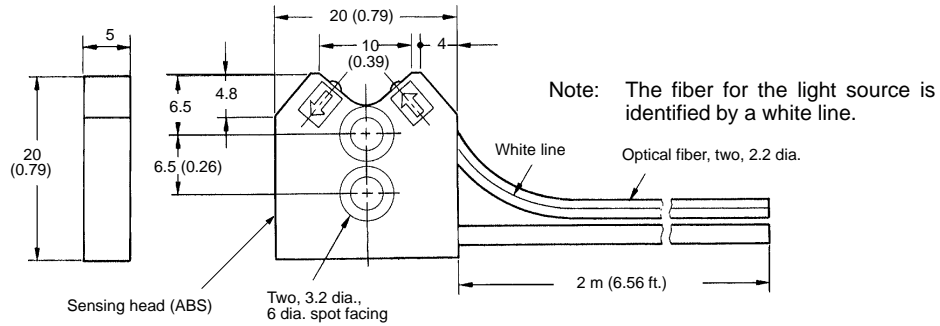

E32-L25A

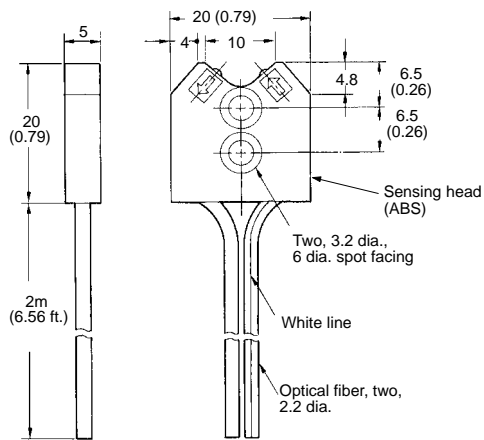

E32-L25L

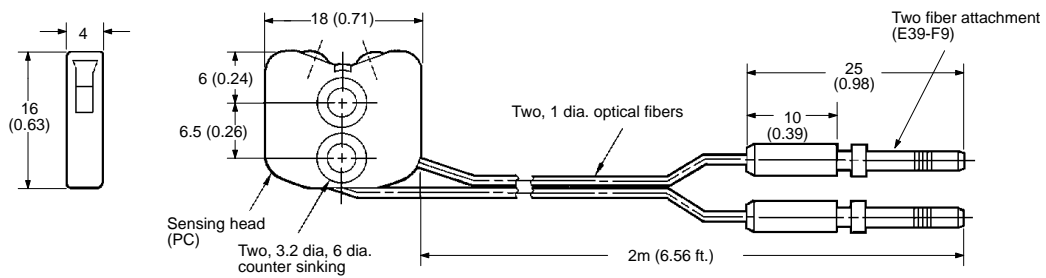

■ RETROREFLECTIVE TYPE

E32-R16

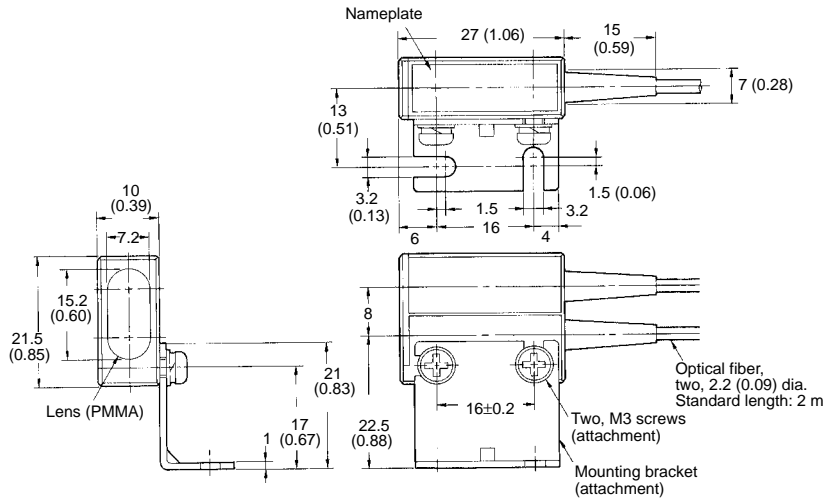

E32-R21

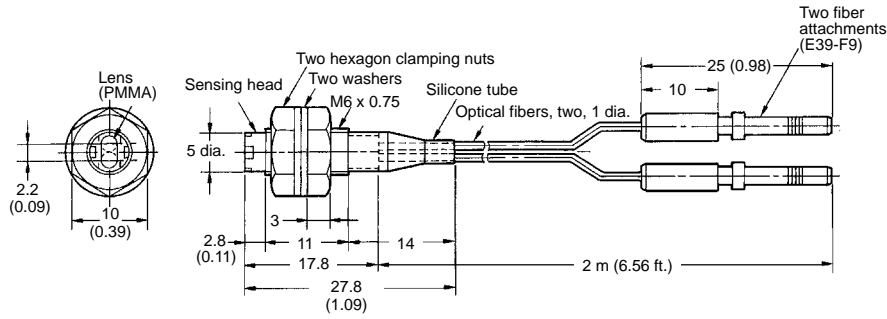

# Installation

## ■ SENSING HEAD

### Mounting Sensing Head in a Panel

Prepare a hole in the panel that can accommodate the threaded cylindrical sensing head. Be sure to place the washer in front of the mounting nut before inserting the sensing head through the hole. Tighten the front mounting nut using no more than the maximum torque recommended in the table.

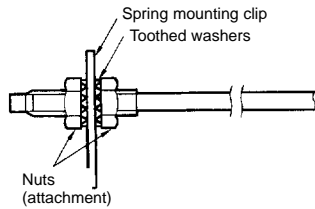

### Mounting Sensing Head in a Channel

Insert the sensing head at the desired location in the channel as shown in the illustration, then use a set screw to fasten the head in place. Apply no more than 2.6 in-lb of force in tightening the set screw.

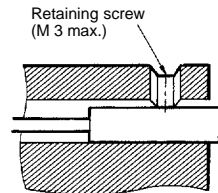

### Tightening Torque

Use a proper-sized wrench and do not exceed the torque recommended for the sensing head.

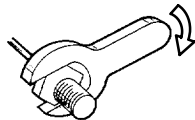

Sensing heads	Maximum torque
M3 and M4 threads	6.88 in-lb
M6 threads	8.66 in-lb
2 mm dia., no thread	2.6 in-lb
3 mm dia., no thread	2.6 in-lb
E32-D14L	8.66 in-lb
E32-T12F	6.88 in-lb
E32-D12F	6.88 in-lb
E32-T16	4.33 in-lb
E32-R21	5.2 in-lb
E32-M21	4.33 in-lb
E32-L25A	6.88 in-lb

## ■ CUTTING FIBER

Insert a fiber into the Fiber and determine the length of the fiber to be cut.

Press down the Fiber Cutter in a single stroke to cut the fiber.

When the fiber is cut, an insertion mark is inscribed on the fiber.

For a 2.2-mm dia. standard fiber only.

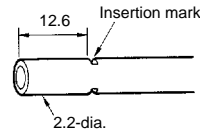

Insert a fiber into the Fiber Cutter in the direction indicated by the arrow (refer to the following figure).

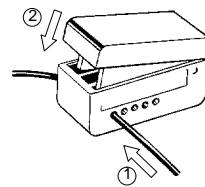

The cutting holes cannot be used twice. If the same hole is used twice, the cutting face of the fiber will be rough and the sensing distance will be reduced. Always use an unused hole.

Use either one of the two holes on the right (refer to the following figure) to cut a thin fiber as follows:

1. An attachment is temporarily fitted to a thin fiber before shipment.

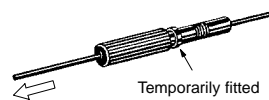

2. Secure the attachment after adjusting the position of it in the direction indicated by the arrow.
3. Insert the fiber into the E39-F4 to cut.

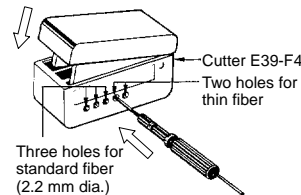

Note: Insert the fiber in the direction indicated by the arrow.

## ■ FIBER UNITS WITH 90° BEND IN STAINLESS STEEL PROBE

### Applicable Models

E32-TC200B/TC200F/DC200F

### Appearance

#### Stainless Steel Probe with a 90° Bend at the Tip

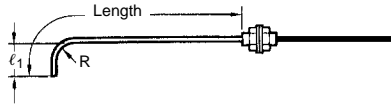

Bending radius	$l_1 (+1)$	
R 5.0	10.0 mm	15.0 mm
R 7.5	12.5 mm	17.5 mm
R 10.0	15.0 mm	20.0 mm
R 12.5	17.5 mm	22.5 mm

The length overall is 120 mm max.

Note: If larger  $l_1$  is required, use the E39-F11 Sleeve Bender.

#### Stainless Steel Probe with a 90° Bend at the Base

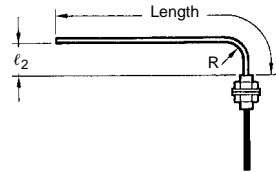

Bending radius	$l_1 (+1)$	
R 5.0	5.0 mm	10.0 mm
R 7.5	7.5 mm	17.5 mm
R 10.0	10.0 mm	20.0 mm
R 12.5	12.5 mm	22.5 mm

The length overall is 120 mm max.

Note: If larger  $l_2$  is required, use the E39-F11 Sleeve Bender.

### Sensing Distance for Probes with 90° Bends

Part number	Amplifier	Bending radius				
		Standard	R5.0	R7.5	R10.0	R12.5
E32-TC200B	E3X-H11	400 mm	260 mm	330 mm	360 mm	400 mm
	E3X-A□□	180 mm	110 mm	140 mm	160 mm	180 mm
E32-TC200F	E3X-H11	100 mm	55 mm	100 mm	100 mm	100 mm
	E3X-A□□	50 mm	30 mm	50 mm	50 mm	50 mm
E32-DC200F	E3X-H11	36 mm	30 mm	36 mm	36 mm	36 mm
	E3X-A□□	18 mm	10 mm	18 mm	18 mm	18 mm

## ■ BENDING RADIUS

### E39-F11 Sleeve Bender

The bending radius of the stainless probe should be as large as possible. The smaller the bending radius becomes, the shorter the sensing distance will be.

Insert the tip of the stainless probe to the Sleeve Bender and bend the stainless probe slowly along the curve of the Sleeve Bender (refer to the figure).

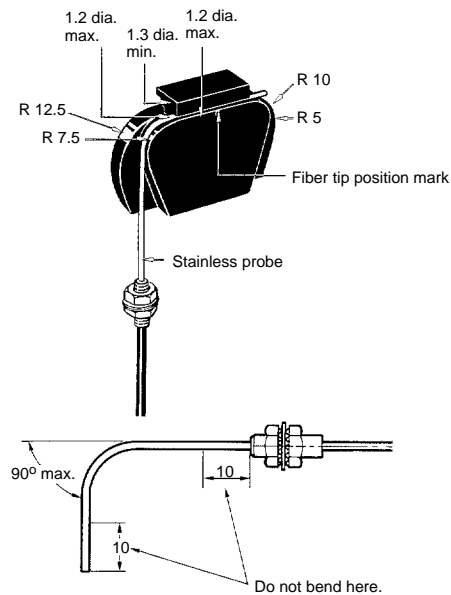

## ■ INSTALLING FIBER CABLES

### Bends in Fiber cables

Plastic and glass filament fiber cables may be bent to avoid obstacles on the way to the sensing site. Here are some guidelines about the location of cable bends: The first bend must be at least 20 mm (0.79 in) away from where the cables enter the amplifier. The last bend must be at least 20 mm (0.79 in) bending the sensing head. We recommend a 25 mm (1.0 in) minimum radius for a right angle bend to maintain the rated sensing distance. The sharpest allowable right angle bend is over a 10 mm (0.39 in) radius, but this will result in a shorter sensing distance. Refer to the bending radius graph.

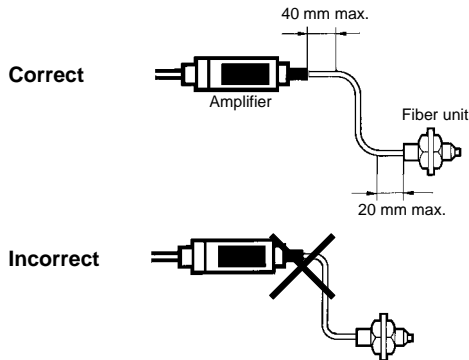

Do not apply excess force on the Fiber Units.

Do not pull or press the Fiber Units. The Fiber Units have a withstand force of 1 kg or 3 kg (pay utmost attention because the fibers are thin).

Do not bend the Fiber Units beyond the permissible bending radius.

Do not bend the edge of the Fiber Units.

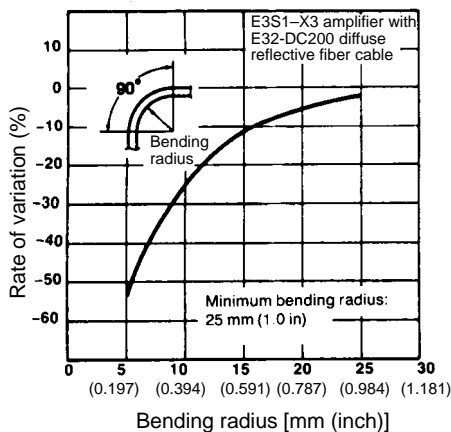

### Proper Supports for Cables

To support the fiber cable between the sensing site and the amplifier, mount the cable using a nylon strap or cable tie. Do not use a U-shaped strap that will compress or put stress on the fiber cable. To prevent damage from excessive vibration, take up the fiber in a loop as shown below.

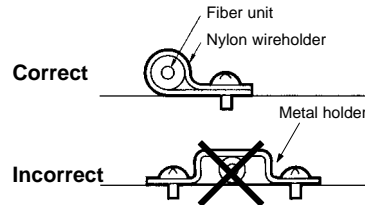

The Fiber Head could be broken by excessive vibration. To prevent this, the following is effective:

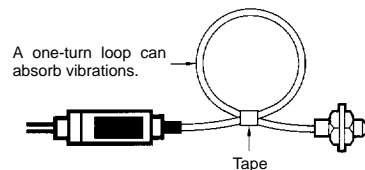

## ■ LONGER FIBER-OPTIC CABLES

### Applicable Models

- E32-TC200/-DC200
- E32-TC200B/-DC200B
- E32-TC200E/-DC200E
- E32-TC200F/-DC200F
- E32-TC200A

### Appearance



The length can be ordered in increments of 1 m between 6 m min. and 20 m max. (2-m and 5-m fiber length types are standard for E32-TC200, E32-DC200.)

### E39-F10 Fiber Connector

Use the following procedure (refer to the figure) to connect fibers via the Fiber Connector.

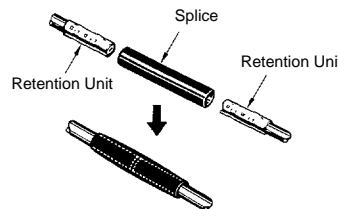

Each fiber should be as close as possible before they are connected.

Sensing distance will be reduced by approximately 25% when fibers are connected.

Only fibers with 2.2 mm dia. can be connected.