

# E3FC

## Best durability for wash-down applications











- High grade steel housing (SUS316L)
- Withstands heat shock conditions
- Epoxy resin preventing water ingress if connector is not fixed properly
- Proven with various industrial detergents of Ecolab and Diversey (Details see page 10)
- Bright visible red LED enabling easy alignment

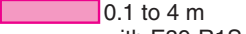

## Ordering Information

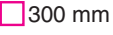
### Sensors

Red light    Infrared light

Sensor type	Sensing distance	Connection method	Model	
			NPN output	PNP output
Through-beam 	 20 m	pre-wired	<b>E3FC-TN11 2M</b> *1	<b>E3FC-TP11 2M</b> *1
		M12 connector	<b>E3FC-TN21</b> *1	<b>E3FC-TP21</b> *1
Retro-reflective with MSR function *2 	 0.1 to 4 m with E39-R1S	pre-wired	<b>E3FC-RN11 2M</b>	<b>E3FC-RP11 2M</b>
		M12 connector	<b>E3FC-RN21</b>	<b>E3FC-RP21</b>
Diffuse-reflective *3 	 300 mm	pre-wired	<b>E3FC-DN12 2M</b>	<b>E3FC-DP12 2M</b>
		M12 connector	<b>E3FC-DN22</b>	<b>E3FC-DP22</b>
	 1 m	pre-wired	<b>E3FC-DN13 2M</b>	<b>E3FC-DP13 2M</b>
		M12 connector	<b>E3FC-DN23</b>	<b>E3FC-DP23</b>
	 300 mm	pre-wired	<b>E3FC-DN15 2M</b>	<b>E3FC-DP15 2M</b>
		M12 connector	<b>E3FC-DN25</b>	<b>E3FC-DP25</b>
	 1 m	pre-wired	<b>E3FC-DN16 2M</b>	<b>E3FC-DP16 2M</b>
		M12 connector	<b>E3FC-DN26</b>	<b>E3FC-DP26</b>
BGS *3 (background suppression) 	 100 mm	pre-wired	<b>E3FC-LN11 2M</b>	<b>E3FC-LP11 2M</b>
		M12 connector	<b>E3FC-LN21</b>	<b>E3FC-LP21</b>
	 200 mm	pre-wired	<b>E3FC-LN12 2M</b>	<b>E3FC-LP12 2M</b>
		M12 connector	<b>E3FC-LN22</b>	<b>E3FC-LP22</b>

\*1. The set type includes the emitter and receiver.

\*2. The Reflector is sold separately. Select the Reflector model most suited to the application.

\*3. L-On fixed output available for Diffuse reflective and BGS models. Please add "A" in order code (e.g. E3FC-DP11A 2M)

# E3FC

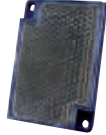

## Reflectors [Refer to Dimensions on page 11.]

Reflectors required for Retro-reflective Sensors: A Reflector is not provided with the Sensor. Be sure to order a Reflector separately.

Sensing distance	Appearance	Model	Remarks
0.1 to 4 m		E39-R1S	IP67
0.1 to 4 m		E39-R50	IP67, IP69K Ecolab tested plastic material

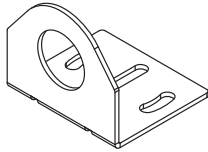

## Mounting brackets [Refer to Dimensions on page 11.]

A Mounting Bracket is not enclosed with the Sensor. Order a Mounting Bracket separately if required.

Sensor	Appearance	Model (Material)	Remarks
all types		E39-L183 (SUS304)	Mounting bracket
		E39-EL16 (SUS316L)	M18 Flush mounting nut

## Sensor I/O connectors

Models for Connectors: A Connector is not provided with the Sensor. Be sure to order a Connector separately.

Sensor	Model	Material	Appearance	Cable type	Model	
M12 connector types	Detergent resistant connector cable	Cable: Detergent resistant PVC Connector: SUS316L	Straight 	2 m	4-wire	Y92E-S12PVC4S2M-L
				5 m		Y92E-S12PVC4S5M-L
			Angle 	2 m		Y92E-S12PVC4A2M-L
				5 m		Y92E-S12PVC4A5M-L

## Ratings and Specifications

Model	Sensing method		Through-beam	Retro-reflective with MSR function
	NPN output	Pre-wired	E3FC-TN11 2M	E3FC-RN11 2M
M12 Connector		E3FC-TN21	E3FC-RN21	
PNP output	Pre-wired	E3FC-TP11 2M	E3FC-RP11 2M	
	M12 Connector	E3FC-TP21	E3FC-RP21	
Item				
Sensing distance		20 m	0.1 to 4 m (with E39-R1S)	
Spot diameter (reference value)		—		
Standard sensing object		Opaque: 7 mm dia.min.	Opaque: 75 mm dia.min.	
Differential travel		—		
Directional angle		2° min.		
Light source (wavelength)		Red LED (624 nm)	Red LED (624 nm)	
Power supply voltage		10 to 30 VDC (include voltage ripple of 10%(p-p) max.)		
Current consumption		40 mA max. (Emitter 25 mA max. Receiver 15 mA max.)	25 mA max.	
Control output		NPN/PNP (open collector) Load current: 100 mA max. (Residual voltage: 3 V max.), Load power supply voltage: 30 VDC max.		
Operation mode		Light-ON/Dark-ON selectable by wiring *1.		
Indicator		Operation indicator (orange) Stability indicator (green) Power indicator (green): only Emitter of Through-beam		
Protection circuits		Power supply reverse polarity protection, Output short-circuit protection, and Output reverse polarity protection		
Response time		0.5 ms		
Sensitivity adjustment		Fixed		
Ambient illumination (Receiver side)		Incandescent lamp: 3,000 lx max./ Sunlight: 10,000 lx max.		
Ambient temperature range		Operating: -25 to 55°C/ Storage: -30 to 70°C (with no icing or condensation)		
Ambient humidity range		Operating: 35 to 85%/ Storage: 35 to 95% (with no condensation)		
Insulation resistance		20 MΩ min. at 500 VDC		
Dielectric strength		1,000 VAC at 50/60 Hz for 1 min. between current-carrying parts and case		
Vibration resistance		Destruction: 10 to 55 Hz, 1.5 mm double amplitude for 2 hours each in X, Y and Z directions		
Shock resistance		Destruction: 500 m/s <sup>2</sup> 3 times each in X, Y and Z directions		
Degree of protection		IEC: IP67, IP68 *2., DIN 40050-9: IP69K *3.		
Weight	Pre-wired cable (2M)	152 g	76 g	
	Connector	44 g	22 g	
Material	Case	SUS 316L (1.4404)		
	Lens and Display	PMMA		
	Adjuster	—		
	Nut	SUS 316L (1.4404)		
Accessories		Instruction sheet M18 nuts (4 pcs)	Instruction sheet M18 nuts (2 pcs)	

\*1. L-On fixed output available for Diffuse reflective and BGS models. Please add "A" in order code (e.g. E3FC-DP11A 2M)

\*2. IP68 Degree of Protection Specifications

IP68 is defined by heat shock resistance with 20 test cycles of 30 min. changing between 3° and 60° surface tensioned water.

\*3. IP69K Degree of Protection Specifications

IP69K is a protection specification stipulated by DIN 40050 Part 9 of the German standards.

The test item is sprayed with 80°C water from a nozzle of a specified shape at a water pressure of 80 to 100 bar. The amount of water is 14 to 16 liters per minute.

The distance between the test item and the nozzle is 10 to 15 cm. The water is discharged at angles of 0°, 30°, 60°, and 90° from the horizontal plane for 30 seconds at each angle while the test item is rotated horizontally.

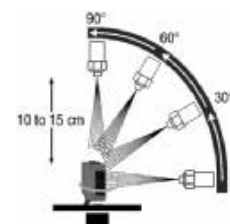

Model	Sensing method		Diffuse-reflective			
	NPN output	Pre-wired M12 Connector	E3FC-DN12 2M	E3FC-DN13 2M	E3FC-DN15 2M	E3FC-DN16 2M
Item	PNP output	Pre-wired M12 Connector	E3FC-DP12 2M	E3FC-DP13 2M	E3FC-DP15 2M	E3FC-DP16 2M
			E3FC-DP22	E3FC-DP23	E3FC-DP25	E3FC-DP26
<b>Sensing distance</b>			300 mm (white paper: 300 × 300 mm)	1 m (white paper: 300 × 300 mm)	300 mm (white paper: 300 × 300 mm)	1 m (white paper: 300 × 300 mm)
<b>Spot diameter (reference value)</b>			40 × 50 mm Sensing distance of 300 mm	120 × 150 mm Sensing distance of 1 m	40 × 50 mm Sensing distance of 300 mm	120 × 150 mm Sensing distance of 1 m
<b>Standard sensing object</b>			—			
<b>Differential travel</b>			20% max.			
<b>Directional angle</b>			—			
<b>Light source (wavelength)</b>			Red LED (624 nm)		Infrared LED (850 nm)	
<b>Power supply voltage</b>			10 to 30 VDC (include voltage ripple of 10%(p-p) max.)			
<b>Current consumption</b>			25 mA max.			
<b>Control output</b>			NPN/PNP (open collector) Load current: 100 mA max. (Residual voltage: 3 V max.), Load power supply voltage: 30 VDC max.			
<b>Operation mode</b>			Light-ON/Dark-ON selectable by wiring *3.			
<b>Indicator</b>			Operation indicator (orange) Stability indicator (green)			
<b>Protection circuits</b>			Power supply reverse polarity protection, Output short-circuit protection, and Output reverse polarity protection			
<b>Response time</b>			0.5 ms			
<b>Sensitivity adjustment</b>			One-turn adjuster			
<b>Ambient illumination</b>			Incandescent lamp: 3,000 lx max./ Sunlight: 10,000 lx max.			
<b>Ambient temperature range</b>			Operating: -25 to 55°C/ Storage: -30 to 70°C (with no icing or condensation)			
<b>Ambient humidity range</b>			Operating: 35 to 85%/ Storage: 35 to 95% (with no condensation)			
<b>Insulation resistance</b>			20 MΩ min. at 500 VDC			
<b>Dielectric strength</b>			1,000 VAC at 50/60 Hz for 1 min. between current-carrying parts and case			
<b>Vibration resistance</b>			Destruction: 10 to 55 Hz, 1.5 mm double amplitude for 2 hours each in X, Y and Z directions			
<b>Shock resistance</b>			Destruction: 500 m/s <sup>2</sup> 3 times each in X, Y and Z directions			
<b>Degree of protection</b>			IEC: IP67, IP68 *2., DIN 40050-9: IP69K *3.			
<b>Weight</b>	<b>Pre-wired cable (2M)</b>		76 g			
	<b>Connector</b>		22 g			
<b>Material</b>	<b>Case</b>		SUS 316L (1.4404)			
	<b>Lens and Display</b>		PMMA			
	<b>Adjuster</b>		POM			
	<b>Nut</b>		SUS 316L (1.4404)			
<b>Accessories</b>			Instruction sheet M18 nuts (2 pcs)			

\*1. L-On fixed output available for Diffuse reflective and BGS models. Please add "A" in order code (e.g. E3FC-DP11A 2M)

\*2. IP68 Degree of Protection Specifications

IP68 is defined by heat shock resistance with 20 test cycles of 30 min. changing between 3° and 60° surface tensioned water.

\*3. IP69K Degree of Protection Specifications

IP69K is a protection specification stipulated by DIN 40050 Part 9 of the German standards.

The test item is sprayed with 80°C water from a nozzle of a specified shape at a water pressure of 80 to 100 bar. The amount of water is 14 to 16 liters per minute.

The distance between the test item and the nozzle is 10 to 15 cm. The water is discharged at angles of 0°, 30°, 60°, and 90° from the horizontal plane for 30 seconds at each angle while the test item is rotated horizontally.

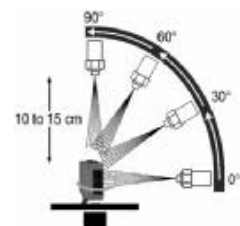

Model	Sensing method		BGS (Background suppression)	
	NPN output	Pre-wired	E3FC-LN11 2M	E3FC-LN12 2M
Item	PNP output	M12 Connector	E3FC-LN21	E3FC-LN22
		Pre-wired	E3FC-LP11 2M	E3FC-LP12 2M
		M12 Connector	E3FC-LP21	E3FC-LP22
Sensing distance			100 mm (white paper: 300 × 300 mm)	200 mm (white paper: 300 × 300 mm)
Spot diameter (reference value)			10 × 10 mm Sensing distance of 100 mm	10 × 15 mm Sensing distance of 200 mm
Standard sensing object			—	
Differential travel			20% max.	
Directional angle			—	
Light source (wavelength)			Red LED (624 nm)	
Power supply voltage			10 to 30 VDC (include voltage ripple of 10%(p-p) max.)	
Current consumption			25 mA max.	
Control output			NPN/PNP (open collector) Load current: 100 mA max. (Residual voltage: 3 V max.), Load power supply voltage: 30 VDC max.	
Operation mode			Light-ON/Dark-ON selectable by wiring *1.	
Indicator			Operation indicator (orange) Stability indicator (green)	
Protection circuits			Power supply reverse polarity protection, Output short-circuit protection, and Output reverse polarity protection	
Response time			0.5 ms	
Sensitivity adjustment			Fixed	
Ambient illumination			Incandescent lamp: 3,000 lx max./ Sunlight: 10,000 lx max.	
Ambient temperature range			Operating: -25 to 55°C/ Storage: -30 to 70°C (with no icing or condensation)	
Ambient humidity range			Operating: 35 to 85%/ Storage: 35 to 95% (with no condensation)	
Insulation resistance			20 MΩ min. at 500 VDC	
Dielectric strength			1,000 VAC at 50/60 Hz for 1 min. between current-carrying parts and case	
Vibration resistance			Destruction: 10 to 55 Hz, 1.5 mm double amplitude for 2 hours each in X, Y and Z directions	
Shock resistance			Destruction: 500 m/s <sup>2</sup> 3 times each in X, Y and Z directions	
Degree of protection			IEC: IP67, IP68 *2., DIN 40050-9: IP69K *3.	
Weight (packed state/only sensor)	Pre-wired cable (2M)		76 g	
	Connector		22 g	
Material	Case		SUS316L (1.4404)	
	Lens and Display		PMMA	
	Adjuster		—	
	Nut		SUS316L (1.4404)	
Accessories			Instruction sheet M18 nuts (2 pcs)	

\*1. L-On fixed output available for Diffuse reflective and BGS models. Please add "A" in order code (e.g. E3FC-DP11A 2M)

\*2. IP68 Degree of Protection Specifications

IP68 is defined by heat shock resistance with 20 test cycles of 30 min. changing between 3° and 60° surface tensioned water.

\*3. IP69K Degree of Protection Specifications

IP69K is a protection specification stipulated by DIN 40050 Part 9 of the German standards.

The test item is sprayed with 80°C water from a nozzle of a specified shape at a water pressure of 80 to 100 bar. The amount of water is 14 to 16 liters per minute.

The distance between the test item and the nozzle is 10 to 15 cm. The water is discharged at angles of 0°, 30°, 60°, and 90° from the horizontal plane for 30 seconds at each angle while the test item is rotated horizontally.

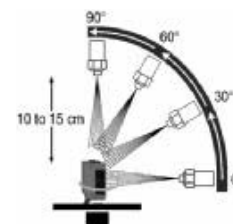

# E3FC

## Engineering Data (Reference Value)

### Parallel Operating Range

#### Through-beam Models

##### E3FC-T□

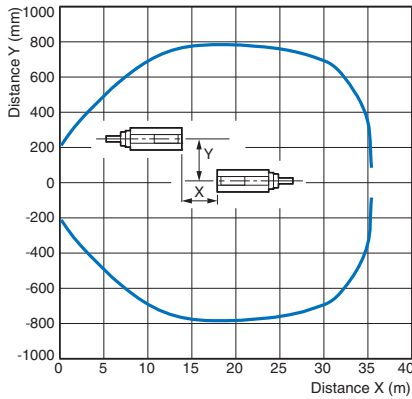

#### Retro-reflective Models (with MSR function)

##### E3FC-R□

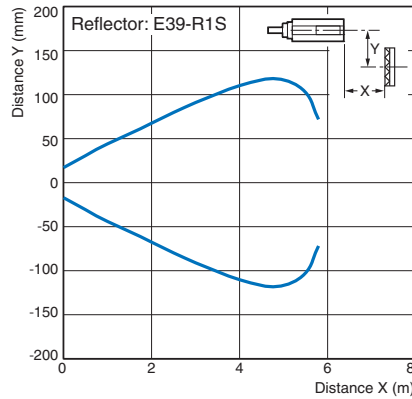

### Operating Range

#### Diffuse-reflective Models

##### E3FC-D□2

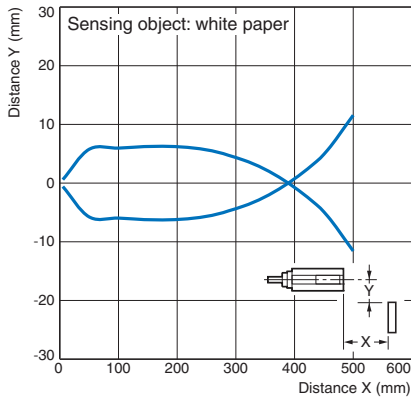

##### E3FC-D□3

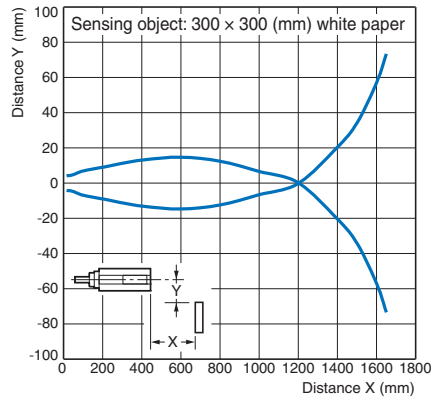

##### E3FC-D□5

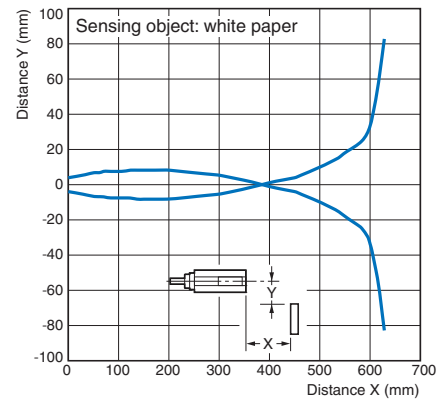

##### E3FC-D□6

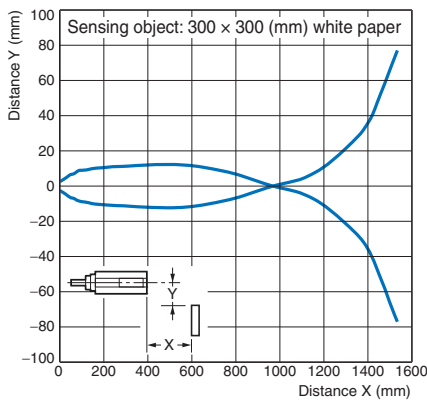

#### BGS Models

##### E3FC-L□1, E3FC-L□2

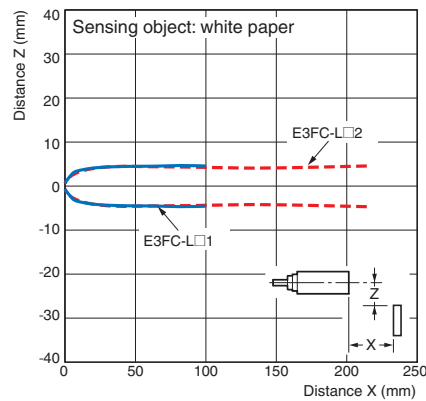

**Excess Gain vs. Distance**  
**Through-beam Models**  
**E3FC-T□□**

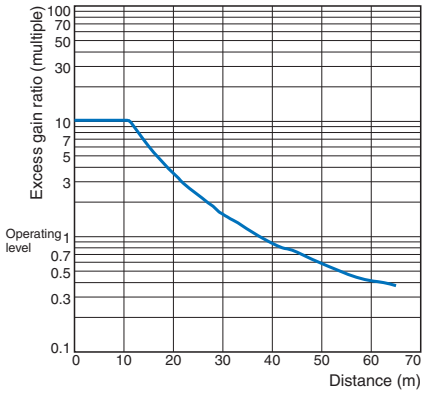

**Retro-reflective Models (with MSR function)**  
**E3FC-R□□**

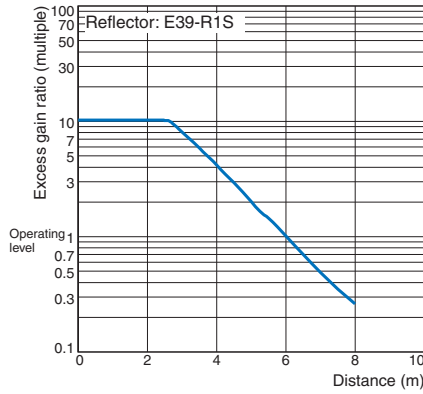

**Diffuse-reflective Models**  
**E3FC-D□□2**

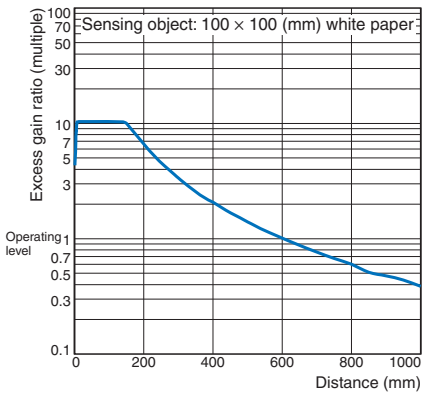

**E3FC-D□□3**

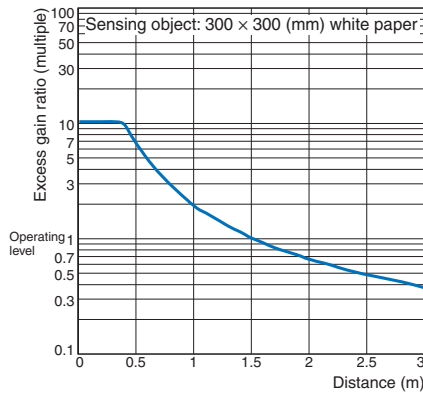

**E3FC-D□□5**

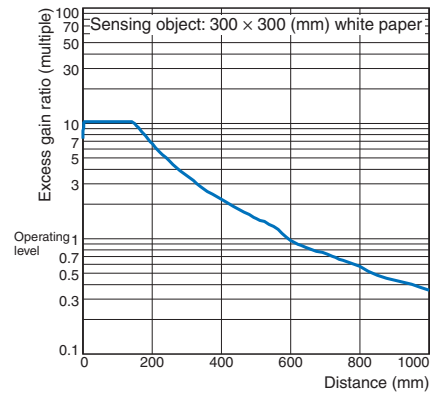

**E3FC-D□□6**

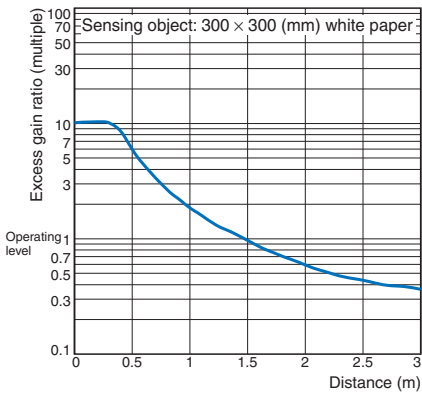

**Sensing Distance vs. Sensing Object Material**

**BGS Models**  
**E3FC-L□□1**

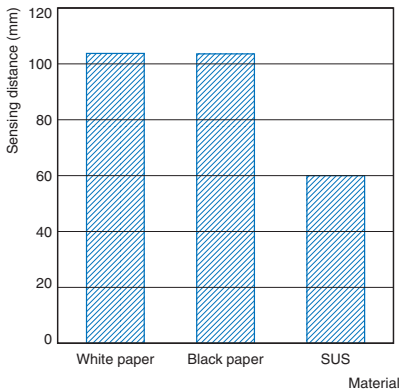

**E3FC-L□□2**

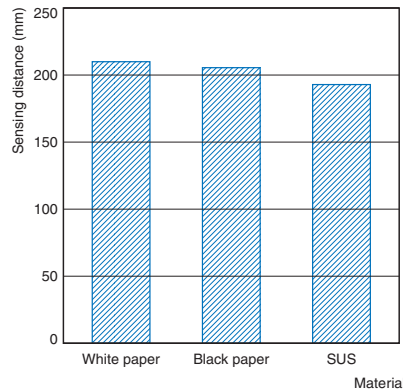

# E3FC

## Output circuit diagram

### PNP Output

Model	Operation mode	Timing charts	Operation selector	Output circuit
E3FC-TP□ E3FC-RP□ E3FC-DP□	Light-ON		Connect the pink wire (Pin(2)) to the brown (Pin(1))	<p>Through-beam Receivers, Retro-reflective Models, Diffuse-reflective Models</p>
	Dark-ON		Connect the pink wire (Pin(2)) to the blue (Pin(3)) or open the pink wire (Pin(2))	
<p>Through-beam Emitter</p>				
E3FC-LP□	Light-ON		Connect the pink wire (Pin(2)) to the brown (Pin(1))	<p>Background suppression.</p>
	Dark-ON		Connect the pink wire (Pin(2)) to the blue (Pin(3)) or open the pink wire (Pin(2))	



## NPN Output

Model	Operation mode	Timing charts	Operation selector	Output circuit
E3FC-TN□ E3FC-RN□ E3FC-DN□	Light-ON	Light incident: ON Light interrupted: OFF Operation indicator (orange): ON Output transistor: ON Load (e.g., relay): Operate Reset: (Between brown and black leads)	Connect the pink wire (Pin(2)) to the brown (Pin(1)) or open the pink wire (Pin(2))	Through-beam Receivers, Retro-reflective Models, Diffuse-reflective Models 
	Dark-ON	Light incident: ON Light interrupted: OFF Operation indicator (orange): OFF Output transistor: OFF Load (e.g., relay): Operate Reset: (Between brown and black leads)	Connect the pink wire (Pin(2)) to the blue (Pin(3))	
Through-beam Emitter 				
E3FC-LN□	Light-ON	NEAR FAR Operation indicator (orange): ON OFF Output transistor: ON OFF Load (e.g., relay): Operate Reset: (Between brown and black leads)	Connect the pink wire (Pin(2)) to the brown (Pin(1)) or open the pink wire (Pin(2))	Background suppression. 
	Dark-ON	NEAR FAR Operation indicator (orange): ON OFF Output transistor: ON OFF Load (e.g., relay): Operate Reset: (Between brown and black leads)	Connect the pink wire (Pin(2)) to the blue (Pin(3))	

### Connector Pin Arrangement M12 Connector Pin Arrangement



### Connectors (Sensor I/O connectors) M12 4-wire Connectors

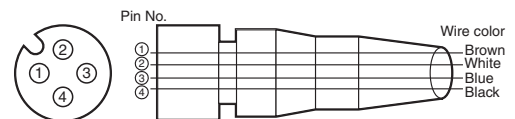

Classification	Wire color	Connector pin No.	Application
DC	Brown	①	Power supply (+V)
	White	②	L/on · D/on selectable
	Blue	③	Power supply (0 V)
	Black	④	Output

# E3FC

## Safety Precautions

Refer to *Warranty and Limitations of Liability*.

### WARNING

This product is not designed or rated for directly or indirectly ensuring safety of persons. Do not use it for such a purpose.



### CAUTION

Never use the product with an AC power supply. Do not use the product with voltage in excess of the rated voltage.



Do not use the product with incorrect wiring. Otherwise, explosion, fire, malfunction may result.



### Precautions for Safe Use

Be sure to follow the safety precautions below for added safety.

1. Do not use the sensor under the environment with explosive, flammable or corrosive gas.
2. Do not use the sensor under the oil or chemical environment exceeding specifications. Performance is assured for typical detergents and disinfectants used in Food & Beverage industry.

Refer to the following table when using these agents:

Manufacturer	Product name	Concentration	Testtime
Diversey	Diverfoam SMS HD	5%	720 h
	Oxofoam	5%	720 h
	Acifoam	5%	720 h
	Divosan Hypochlorit	1%	720 h
	Divosan Forte	1%	720 h
Ecolab	P3-topactive® 200	5%	720 h
	P3-topax® 56	5%	720 h
	P3-topactive® OKTO	3%	720 h
	P3-topax® 990	3%	720 h
	P3-topax® 66	3%	720 h

3. Do not use the sensor under the environment under the other conditions in excess of rated.
4. Do not use the sensor in place that is exposed by direct sunlight.
5. Do not use the sensor in place where the sensor may receive direct vibration or shock.
6. Do not use the thinner, alcohol, or other organic solvents.
7. Never disassemble, repair nor tamper with the sensor.
8. Please process it as industrial waste.

### Precautions for Correct Use

1. Laying Sensor wiring in the same conduit or duct as high-voltage wires or power lines may result in malfunction or damage due to conduit or use shielded cable.
2. Do not pull on the cable with excessive force.
3. If a commercial switching regulator is used, ground the FG (frame ground) terminal.
4. The sensor will be available 100 ms after the power supply is tuned ON. Start to use the sensor 100 ms or more after turning ON the power supply. If the load and the sensor are connected to separate power supplies, be sure to turn ON the sensor first.
5. Output pulses may be generated even when the power supply is OFF. Therefore, it is recommended to first turn OFF the power supply for the load or the load line.
6. The sensor must be mounted using the provided nuts. The proper tightening torque is 20 N·m max..

## Dimensions

(Unit: mm)  
Tolerance class IT16 applies to dimensions in this data sheet unless otherwise specified.

### Sensors

#### Pre-wired Models

- E3FC-T□□□
- E3FC-R□□□
- E3FC-D□□□
- E3FC-L□□□

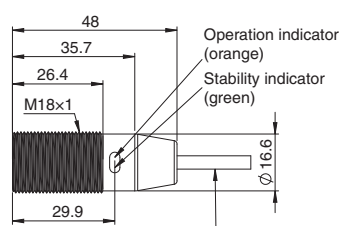

Vinyl insulated round cord 4 dia. 4 cores (conductor cross sectional area: 0.128 mm<sup>2</sup> (AWG26)/insulation outside diameter: 0.85 dia.) standard length 2 m

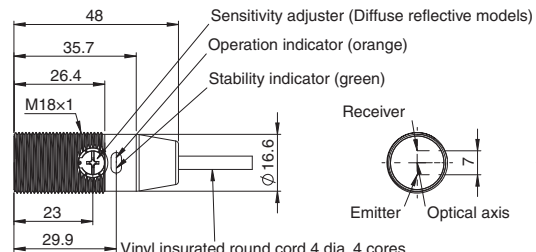

Vinyl insulated round cord 4 dia. 4 cores (conductor cross sectional area: 0.128 mm<sup>2</sup> (AWG26)/insulation outside diameter: 0.85 dia.) standard length 2 m

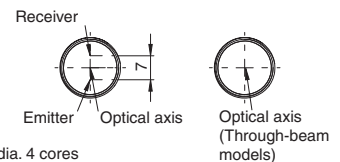

**M12 Connector Models**

- E3FC-T□□
- E3FC-R□□
- E3FC-D□□
- E3FC-L□□

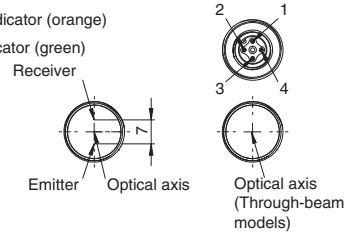
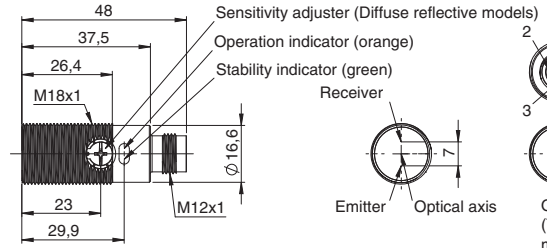
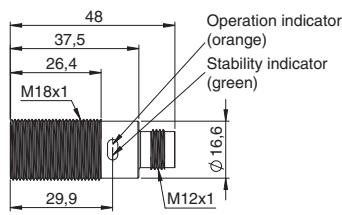

Terminal No.	Specification
1	+V
2	L/on · D/on selectable
3	0V
4	Output

**Attached nut**

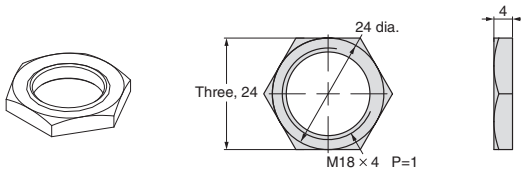

**Accessories (Order Separately)**

**Reflectors**

**E39-R1S**

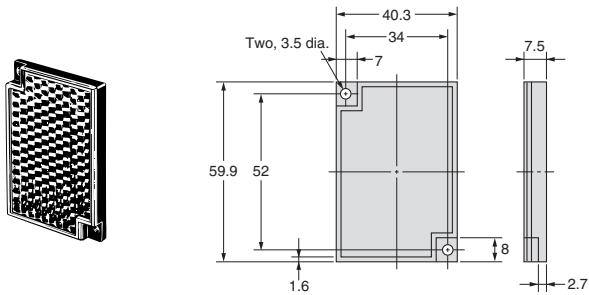

**E39-R50**

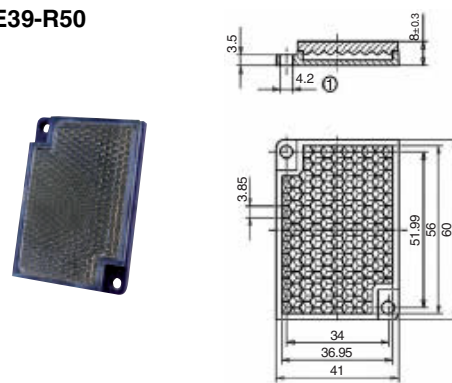

**Mounting brackets**

**E39-L183**

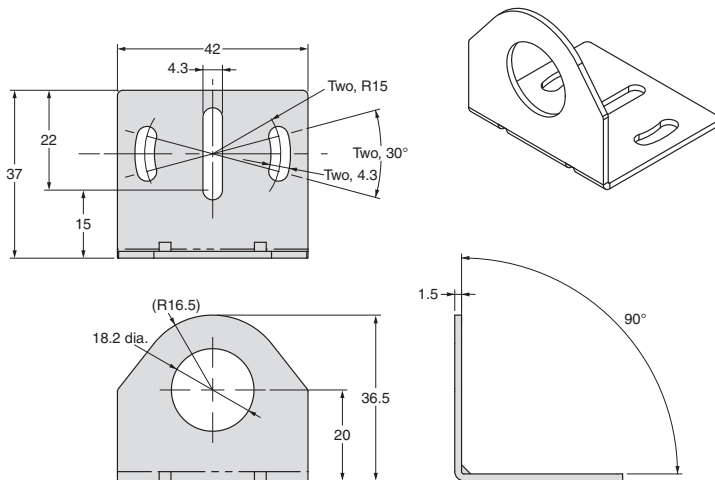

**Flush mounting nut**

**E39-EL16**

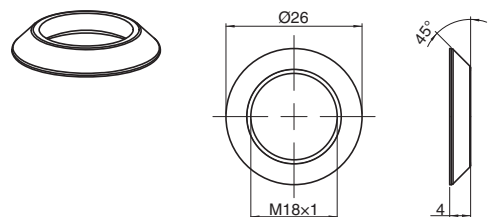

ALL DIMENSIONS SHOWN ARE IN MILLIMETERS.  
 To convert millimeters into inches, multiply by 0.03937. To convert grams into ounces, multiply by 0.03527.