

E3FC

Best durability for wash-down applications











- High grade steel housing (SUS316L)
- Withstands heat shock conditions
- Epoxy resin preventing water ingress if connector is not fixed properly
- Proven with various industrial detergents of Ecolab and Diversey (Details see page 10)
- Bright visible red LED enabling easy alignment

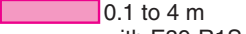

Ordering Information

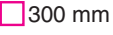
Sensors

Red light Infrared light

Sensor type	Sensing distance	Connection method	Model	
			NPN output	PNP output
Through-beam 	 20 m	pre-wired	E3FC-TN11 2M *1	E3FC-TP11 2M *1
		M12 connector	E3FC-TN21 *1	E3FC-TP21 *1
Retro-reflective with MSR function *2 	 0.1 to 4 m with E39-R1S	pre-wired	E3FC-RN11 2M	E3FC-RP11 2M
		M12 connector	E3FC-RN21	E3FC-RP21
Diffuse-reflective *3 	 300 mm	pre-wired	E3FC-DN12 2M	E3FC-DP12 2M
		M12 connector	E3FC-DN22	E3FC-DP22
	 1 m	pre-wired	E3FC-DN13 2M	E3FC-DP13 2M
		M12 connector	E3FC-DN23	E3FC-DP23
	 300 mm	pre-wired	E3FC-DN15 2M	E3FC-DP15 2M
		M12 connector	E3FC-DN25	E3FC-DP25
	 1 m	pre-wired	E3FC-DN16 2M	E3FC-DP16 2M
		M12 connector	E3FC-DN26	E3FC-DP26
BGS *3 (background suppression) 	 100 mm	pre-wired	E3FC-LN11 2M	E3FC-LP11 2M
		M12 connector	E3FC-LN21	E3FC-LP21
	 200 mm	pre-wired	E3FC-LN12 2M	E3FC-LP12 2M
		M12 connector	E3FC-LN22	E3FC-LP22

*1. The set type includes the emitter and receiver.

*2. The Reflector is sold separately. Select the Reflector model most suited to the application.

*3. L-On fixed output available for Diffuse reflective and BGS models. Please add "A" in order code (e.g. E3FC-DP11A 2M)

E3FC

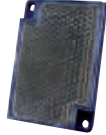

Reflectors [Refer to Dimensions on page 11.]

Reflectors required for Retro-reflective Sensors: A Reflector is not provided with the Sensor. Be sure to order a Reflector separately.

Sensing distance	Appearance	Model	Remarks
0.1 to 4 m		E39-R1S	IP67
0.1 to 4 m		E39-R50	IP67, IP69K Ecolab tested plastic material

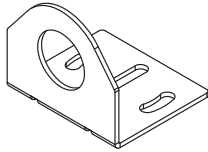

Mounting brackets [Refer to Dimensions on page 11.]

A Mounting Bracket is not enclosed with the Sensor. Order a Mounting Bracket separately if required.

Sensor	Appearance	Model (Material)	Remarks
all types		E39-L183 (SUS304)	Mounting bracket
		E39-EL16 (SUS316L)	M18 Flush mounting nut

Sensor I/O connectors

Models for Connectors: A Connector is not provided with the Sensor. Be sure to order a Connector separately.

Sensor	Model	Material	Appearance	Cable type	Model	
M12 connector types	Detergent resistant connector cable	Cable: Detergent resistant PVC Connector: SUS316L	Straight 	2 m	4-wire	Y92E-S12PVC4S2M-L
				5 m		Y92E-S12PVC4S5M-L
			Angle 	2 m		Y92E-S12PVC4A2M-L
				5 m		Y92E-S12PVC4A5M-L

Ratings and Specifications

Model	Sensing method		Through-beam	Retro-reflective with MSR function
	Item	NPN output	Pre-wired	E3FC-TN11 2M
M12 Connector			E3FC-TN21	E3FC-RN21
Item	PNP output	Pre-wired	E3FC-TP11 2M	E3FC-RP11 2M
		M12 Connector	E3FC-TP21	E3FC-RP21
Sensing distance			20 m	0.1 to 4 m (with E39-R1S)
Spot diameter (reference value)			—	
Standard sensing object			Opaque: 7 mm dia.min.	Opaque: 75 mm dia.min.
Differential travel			—	
Directional angle			2° min.	
Light source (wavelength)			Red LED (624 nm)	Red LED (624 nm)
Power supply voltage			10 to 30 VDC (include voltage ripple of 10%(p-p) max.)	
Current consumption			40 mA max. (Emitter 25 mA max. Receiver 15 mA max.)	25 mA max.
Control output			NPN/PNP (open collector) Load current: 100 mA max. (Residual voltage: 3 V max.), Load power supply voltage: 30 VDC max.	
Operation mode			Light-ON/Dark-ON selectable by wiring *1.	
Indicator			Operation indicator (orange) Stability indicator (green) Power indicator (green): only Emitter of Through-beam	
Protection circuits			Power supply reverse polarity protection, Output short-circuit protection, and Output reverse polarity protection	
Response time			0.5 ms	
Sensitivity adjustment			Fixed	
Ambient illumination (Receiver side)			Incandescent lamp: 3,000 lx max./ Sunlight: 10,000 lx max.	
Ambient temperature range			Operating: -25 to 55°C/ Storage: -30 to 70°C (with no icing or condensation)	
Ambient humidity range			Operating: 35 to 85%/ Storage: 35 to 95% (with no condensation)	
Insulation resistance			20 MΩ min. at 500 VDC	
Dielectric strength			1,000 VAC at 50/60 Hz for 1 min. between current-carrying parts and case	
Vibration resistance			Destruction: 10 to 55 Hz, 1.5 mm double amplitude for 2 hours each in X, Y and Z directions	
Shock resistance			Destruction: 500 m/s ² 3 times each in X, Y and Z directions	
Degree of protection			IEC: IP67, IP68 *2., DIN 40050-9: IP69K *3.	
Weight	Pre-wired cable (2M)		152 g	76 g
	Connector		44 g	22 g
Material	Case		SUS 316L (1.4404)	
	Lens and Display		PMMA	
	Adjuster		—	
	Nut		SUS 316L (1.4404)	
Accessories			Instruction sheet M18 nuts (4 pcs)	Instruction sheet M18 nuts (2 pcs)

*1. L-On fixed output available for Diffuse reflective and BGS models. Please add "A" in order code (e.g. E3FC-DP11A 2M)

*2. IP68 Degree of Protection Specifications

IP68 is defined by heat shock resistance with 20 test cycles of 30 min. changing between 3° and 60° surface tensioned water.

*3. IP69K Degree of Protection Specifications

IP69K is a protection specification stipulated by DIN 40050 Part 9 of the German standards.

The test item is sprayed with 80°C water from a nozzle of a specified shape at a water pressure of 80 to 100 bar. The amount of water is 14 to 16 liters per minute.

The distance between the test item and the nozzle is 10 to 15 cm. The water is discharged at angles of 0°, 30°, 60°, and 90° from the horizontal plane for 30 seconds at each angle while the test item is rotated horizontally.

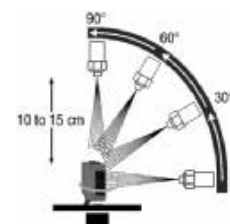

Model	Sensing method		Diffuse-reflective			
	NPN output	Pre-wired	E3FC-DN12 2M	E3FC-DN13 2M	E3FC-DN15 2M	E3FC-DN16 2M
Item		M12 Connector	E3FC-DN22	E3FC-DN23	E3FC-DN25	E3FC-DN26
		PNP output	E3FC-DP12 2M	E3FC-DP13 2M	E3FC-DP15 2M	E3FC-DP16 2M
		M12 Connector	E3FC-DP22	E3FC-DP23	E3FC-DP25	E3FC-DP26
Sensing distance			300 mm (white paper: 300 × 300 mm)	1 m (white paper: 300 × 300 mm)	300 mm (white paper: 300 × 300 mm)	1 m (white paper: 300 × 300 mm)
Spot diameter (reference value)			40 × 50 mm Sensing distance of 300 mm	120 × 150 mm Sensing distance of 1 m	40 × 50 mm Sensing distance of 300 mm	120 × 150 mm Sensing distance of 1 m
Standard sensing object			—			
Differential travel			20% max.			
Directional angle			—			
Light source (wavelength)			Red LED (624 nm)		Infrared LED (850 nm)	
Power supply voltage			10 to 30 VDC (include voltage ripple of 10%(p-p) max.)			
Current consumption			25 mA max.			
Control output			NPN/PNP (open collector) Load current: 100 mA max. (Residual voltage: 3 V max.), Load power supply voltage: 30 VDC max.			
Operation mode			Light-ON/Dark-ON selectable by wiring *3.			
Indicator			Operation indicator (orange) Stability indicator (green)			
Protection circuits			Power supply reverse polarity protection, Output short-circuit protection, and Output reverse polarity protection			
Response time			0.5 ms			
Sensitivity adjustment			One-turn adjuster			
Ambient illumination			Incandescent lamp: 3,000 lx max./ Sunlight: 10,000 lx max.			
Ambient temperature range			Operating: -25 to 55°C/ Storage: -30 to 70°C (with no icing or condensation)			
Ambient humidity range			Operating: 35 to 85%/ Storage: 35 to 95% (with no condensation)			
Insulation resistance			20 MΩ min. at 500 VDC			
Dielectric strength			1,000 VAC at 50/60 Hz for 1 min. between current-carrying parts and case			
Vibration resistance			Destruction: 10 to 55 Hz, 1.5 mm double amplitude for 2 hours each in X, Y and Z directions			
Shock resistance			Destruction: 500 m/s ² 3 times each in X, Y and Z directions			
Degree of protection			IEC: IP67, IP68 *2., DIN 40050-9: IP69K *3.			
Weight	Pre-wired cable (2M)		76 g			
	Connector		22 g			
Material	Case		SUS 316L (1.4404)			
	Lens and Display		PMMA			
	Adjuster		POM			
	Nut		SUS 316L (1.4404)			
Accessories			Instruction sheet M18 nuts (2 pcs)			

*1. L-On fixed output available for Diffuse reflective and BGS models. Please add "A" in order code (e.g. E3FC-DP11A 2M)

*2. IP68 Degree of Protection Specifications

IP68 is defined by heat shock resistance with 20 test cycles of 30 min. changing between 3° and 60° surface tensioned water.

*3. IP69K Degree of Protection Specifications

IP69K is a protection specification stipulated by DIN 40050 Part 9 of the German standards.

The test item is sprayed with 80°C water from a nozzle of a specified shape at a water pressure of 80 to 100 bar. The amount of water is 14 to 16 liters per minute.

The distance between the test item and the nozzle is 10 to 15 cm. The water is discharged at angles of 0°, 30°, 60°, and 90° from the horizontal plane for 30 seconds at each angle while the test item is rotated horizontally.

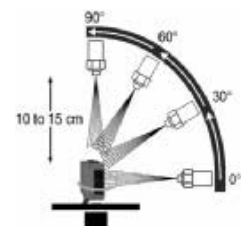

Model	Sensing method		BGS (Background suppression)	
	NPN output	Pre-wired	E3FC-LN11 2M	E3FC-LN12 2M
Item	PNP output	M12 Connector	E3FC-LN21	E3FC-LN22
		Pre-wired	E3FC-LP11 2M	E3FC-LP12 2M
		M12 Connector	E3FC-LP21	E3FC-LP22
Sensing distance			100 mm (white paper: 300 × 300 mm)	200 mm (white paper: 300 × 300 mm)
Spot diameter (reference value)			10 × 10 mm Sensing distance of 100 mm	10 × 15 mm Sensing distance of 200 mm
Standard sensing object			—	
Differential travel			20% max.	
Directional angle			—	
Light source (wavelength)			Red LED (624 nm)	
Power supply voltage			10 to 30 VDC (include voltage ripple of 10%(p-p) max.)	
Current consumption			25 mA max.	
Control output			NPN/PNP (open collector) Load current: 100 mA max. (Residual voltage: 3 V max.), Load power supply voltage: 30 VDC max.	
Operation mode			Light-ON/Dark-ON selectable by wiring *1.	
Indicator			Operation indicator (orange) Stability indicator (green)	
Protection circuits			Power supply reverse polarity protection, Output short-circuit protection, and Output reverse polarity protection	
Response time			0.5 ms	
Sensitivity adjustment			Fixed	
Ambient illumination			Incandescent lamp: 3,000 lx max./ Sunlight: 10,000 lx max.	
Ambient temperature range			Operating: -25 to 55°C/ Storage: -30 to 70°C (with no icing or condensation)	
Ambient humidity range			Operating: 35 to 85%/ Storage: 35 to 95% (with no condensation)	
Insulation resistance			20 MΩ min. at 500 VDC	
Dielectric strength			1,000 VAC at 50/60 Hz for 1 min. between current-carrying parts and case	
Vibration resistance			Destruction: 10 to 55 Hz, 1.5 mm double amplitude for 2 hours each in X, Y and Z directions	
Shock resistance			Destruction: 500 m/s ² 3 times each in X, Y and Z directions	
Degree of protection			IEC: IP67, IP68 *2., DIN 40050-9: IP69K *3.	
Weight (packed state/only sensor)	Pre-wired cable (2M)		76 g	
	Connector		22 g	
Material	Case		SUS316L (1.4404)	
	Lens and Display		PMMA	
	Adjuster		—	
	Nut		SUS316L (1.4404)	
Accessories			Instruction sheet M18 nuts (2 pcs)	

*1. L-On fixed output available for Diffuse reflective and BGS models. Please add "A" in order code (e.g. E3FC-DP11A 2M)

*2. IP68 Degree of Protection Specifications

IP68 is defined by heat shock resistance with 20 test cycles of 30 min. changing between 3° and 60° surface tensioned water.

*3. IP69K Degree of Protection Specifications

IP69K is a protection specification stipulated by DIN 40050 Part 9 of the German standards.

The test item is sprayed with 80°C water from a nozzle of a specified shape at a water pressure of 80 to 100 bar. The amount of water is 14 to 16 liters per minute.

The distance between the test item and the nozzle is 10 to 15 cm. The water is discharged at angles of 0°, 30°, 60°, and 90° from the horizontal plane for 30 seconds at each angle while the test item is rotated horizontally.

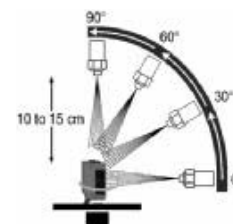

E3FC

Engineering Data (Reference Value)

Parallel Operating Range

Through-beam Models

E3FC-T□

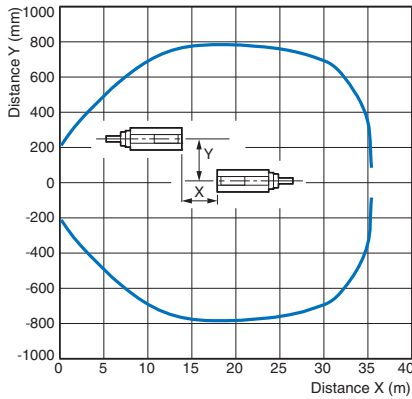

Retro-reflective Models (with MSR function)

E3FC-R□

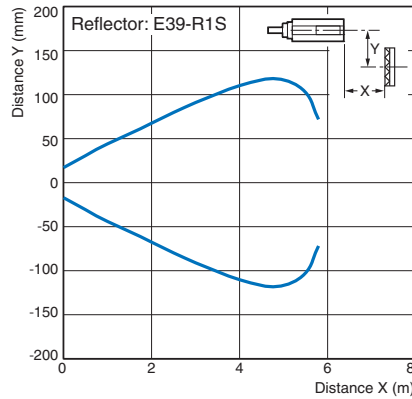

Operating Range

Diffuse-reflective Models

E3FC-D□2

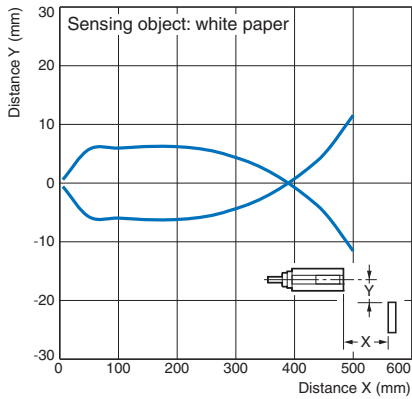

E3FC-D□3

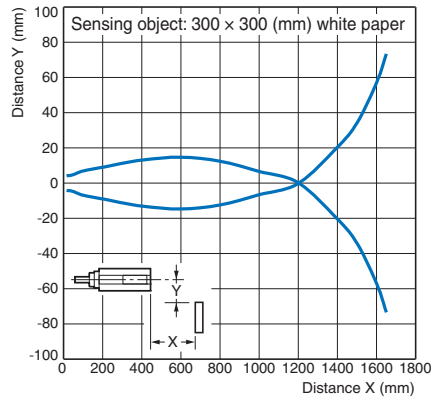

E3FC-D□5

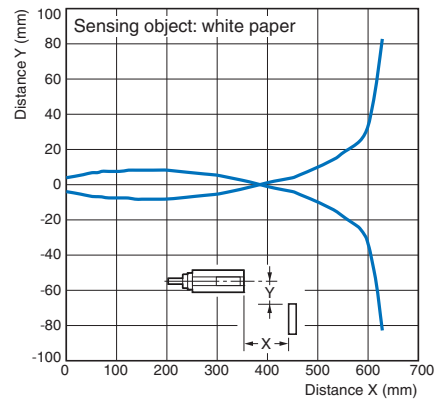

E3FC-D□6

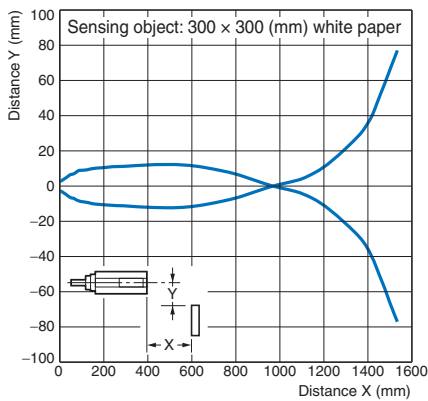

BGS Models

E3FC-L□1, E3FC-L□2

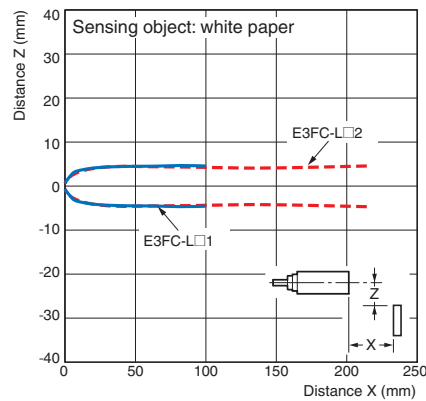

Excess Gain vs. Distance
Through-beam Models
E3FC-T□□

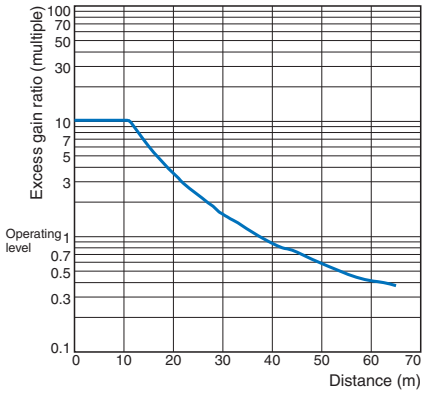

Retro-reflective Models (with MSR function)
E3FC-R□□

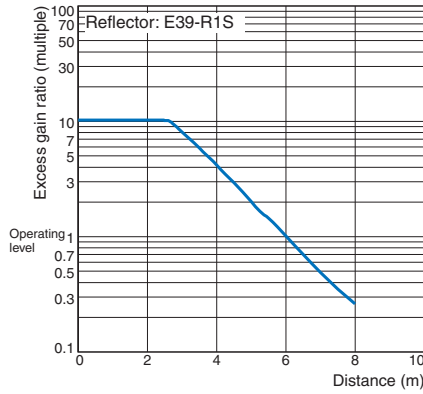

Diffuse-reflective Models
E3FC-D□□2

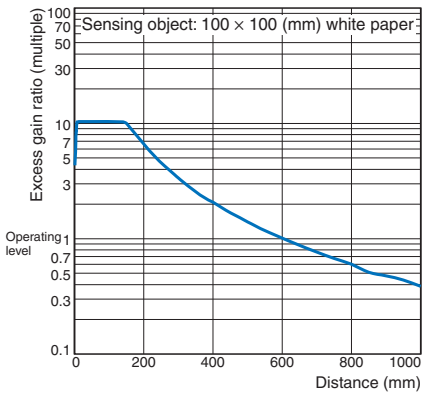

E3FC-D□□3

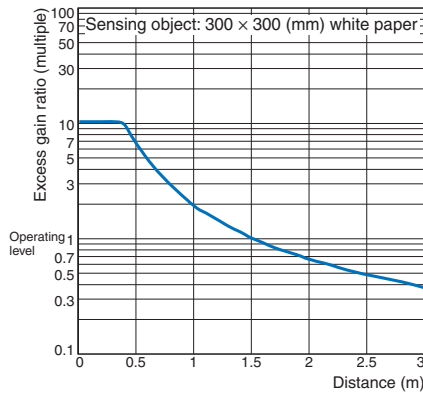

E3FC-D□□5

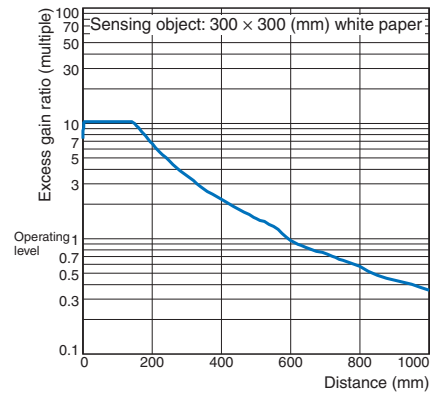

E3FC-D□□6

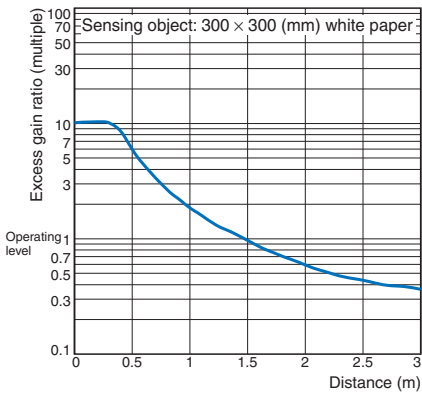

Sensing Distance vs. Sensing Object Material

BGS Models
E3FC-L□□1

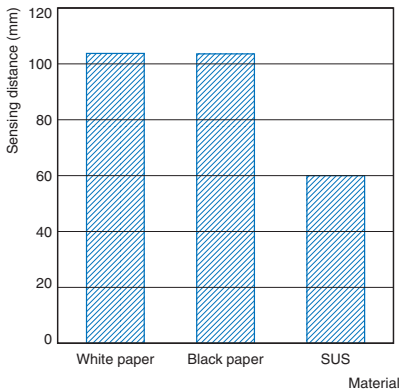

E3FC-L□□2

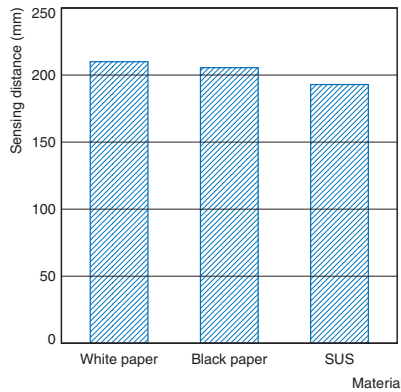

E3FC

Output circuit diagram

PNP Output

Model	Operation mode	Timing charts	Operation selector	Output circuit
E3FC-TP□ E3FC-RP□ E3FC-DP□	Light-ON		Connect the pink wire (Pin(2)) to the brown (Pin(1))	<p>Through-beam Receivers, Retro-reflective Models, Diffuse-reflective Models</p>
	Dark-ON		Connect the pink wire (Pin(2)) to the blue (Pin(3)) or open the pink wire (Pin(2))	
<p>Through-beam Emitter</p>				
E3FC-LP□	Light-ON		Connect the pink wire (Pin(2)) to the brown (Pin(1))	<p>Background suppression.</p>
	Dark-ON		Connect the pink wire (Pin(2)) to the blue (Pin(3)) or open the pink wire (Pin(2))	

NPN Output

Model	Operation mode	Timing charts	Operation selector	Output circuit
E3FC-TN□ E3FC-RN□ E3FC-DN□	Light-ON	Light incident: ON Light interrupted: OFF Operation indicator (orange): ON Output transistor: ON Load (e.g., relay): Operate Reset: (Between brown and black leads)	Connect the pink wire (Pin(2)) to the brown (Pin(1)) or open the pink wire (Pin(2))	Through-beam Receivers, Retro-reflective Models, Diffuse-reflective Models
	Dark-ON	Light incident: ON Light interrupted: OFF Operation indicator (orange): OFF Output transistor: OFF Load (e.g., relay): Operate Reset: (Between brown and black leads)	Connect the pink wire (Pin(2)) to the blue (Pin(3))	
Through-beam Emitter 				
E3FC-LN□	Light-ON	NEAR FAR Operation indicator (orange): ON OFF Output transistor: ON OFF Load (e.g., relay): Operate Reset: (Between brown and black leads)	Connect the pink wire (Pin(2)) to the brown (Pin(1)) or open the pink wire (Pin(2))	Background suppression.
	Dark-ON	NEAR FAR Operation indicator (orange): ON OFF Output transistor: ON OFF Load (e.g., relay): Operate Reset: (Between brown and black leads)	Connect the pink wire (Pin(2)) to the blue (Pin(3))	

Connector Pin Arrangement M12 Connector Pin Arrangement



Connectors (Sensor I/O connectors) M12 4-wire Connectors

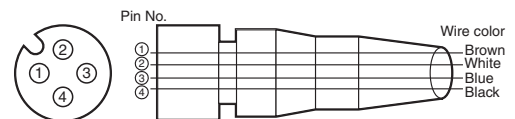

Classification	Wire color	Connector pin No.	Application
DC	Brown	①	Power supply (+V)
	White	②	L/on · D/on selectable
	Blue	③	Power supply (0 V)
	Black	④	Output

E3FC

Safety Precautions

Refer to *Warranty and Limitations of Liability*.

WARNING

This product is not designed or rated for directly or indirectly ensuring safety of persons. Do not use it for such a purpose.



CAUTION

Never use the product with an AC power supply. Do not use the product with voltage in excess of the rated voltage.



Do not use the product with incorrect wiring. Otherwise, explosion, fire, malfunction may result.



Precautions for Safe Use

Be sure to follow the safety precautions below for added safety.

1. Do not use the sensor under the environment with explosive, flammable or corrosive gas.
2. Do not use the sensor under the oil or chemical environment exceeding specifications. Performance is assured for typical detergents and disinfectants used in Food & Beverage industry.

Refer to the following table when using these agents:

Manufacturer	Product name	Concentration	Testtime
Diversey	Diverfoam SMS HD	5%	720 h
	Oxofoam	5%	720 h
	Acifoam	5%	720 h
	Divosan Hypochlorit	1%	720 h
	Divosan Forte	1%	720 h
Ecolab	P3-topactive® 200	5%	720 h
	P3-topax® 56	5%	720 h
	P3-topactive® OKTO	3%	720 h
	P3-topax® 990	3%	720 h
	P3-topax® 66	3%	720 h

3. Do not use the sensor under the environment under the other conditions in excess of rated.
4. Do not use the sensor in place that is exposed by direct sunlight.
5. Do not use the sensor in place where the sensor may receive direct vibration or shock.
6. Do not use the thinner, alcohol, or other organic solvents.
7. Never disassemble, repair nor tamper with the sensor.
8. Please process it as industrial waste.

Precautions for Correct Use

1. Laying Sensor wiring in the same conduit or duct as high-voltage wires or power lines may result in malfunction or damage due to conduit or use shielded cable.
2. Do not pull on the cable with excessive force.
3. If a commercial switching regulator is used, ground the FG (frame ground) terminal.
4. The sensor will be available 100 ms after the power supply is tuned ON. Start to use the sensor 100 ms or more after turning ON the power supply. If the load and the sensor are connected to separate power supplies, be sure to turn ON the sensor first.
5. Output pulses may be generated even when the power supply is OFF. Therefore, it is recommended to first turn OFF the power supply for the load or the load line.
6. The sensor must be mounted using the provided nuts. The proper tightening torque is 20 N·m max..

Dimensions

(Unit: mm)
Tolerance class IT16 applies to dimensions in this data sheet unless otherwise specified.

Sensors

Pre-wired Models

- E3FC-T□□□
- E3FC-R□□□
- E3FC-D□□□
- E3FC-L□□□

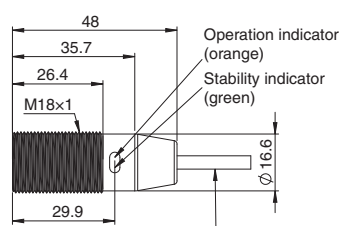

Vinyl insulated round cord 4 dia. 4 cores (conductor cross sectional area: 0.128 mm² (AWG26)/insulation outside diameter: 0.85 dia.) standard length 2 m

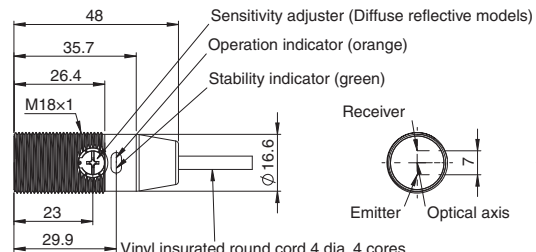

Vinyl insulated round cord 4 dia. 4 cores (conductor cross sectional area: 0.128 mm² (AWG26)/insulation outside diameter: 0.85 dia.) standard length 2 m

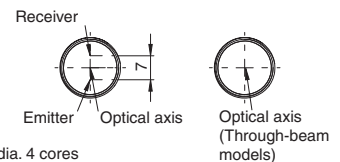

M12 Connector Models

- E3FC-T□□
- E3FC-R□□
- E3FC-D□□
- E3FC-L□□

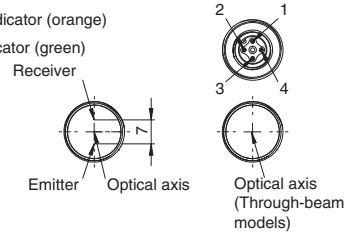
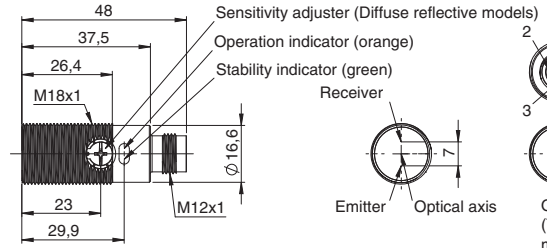
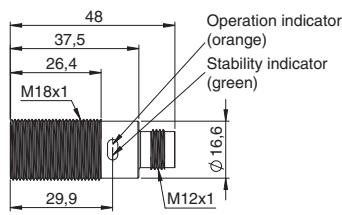

Terminal No.	Specification
1	+V
2	L/on · D/on selectable
3	0V
4	Output

Attached nut

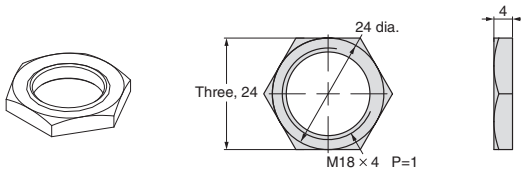

Accessories (Order Separately)

Reflectors

E39-R1S

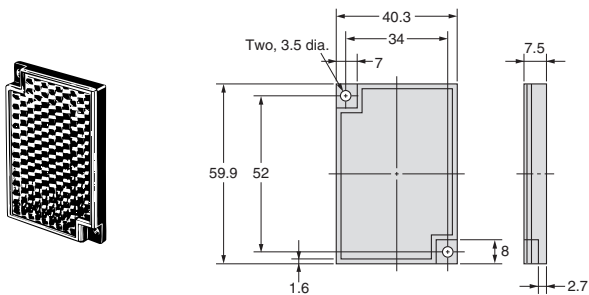

E39-R50

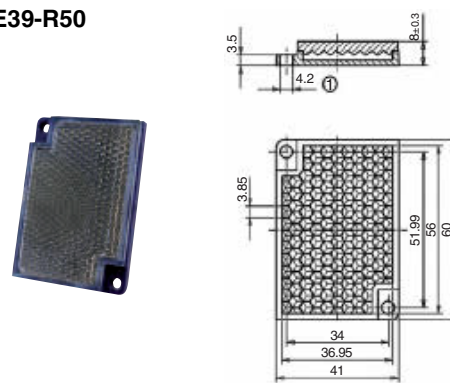

Mounting brackets

E39-L183

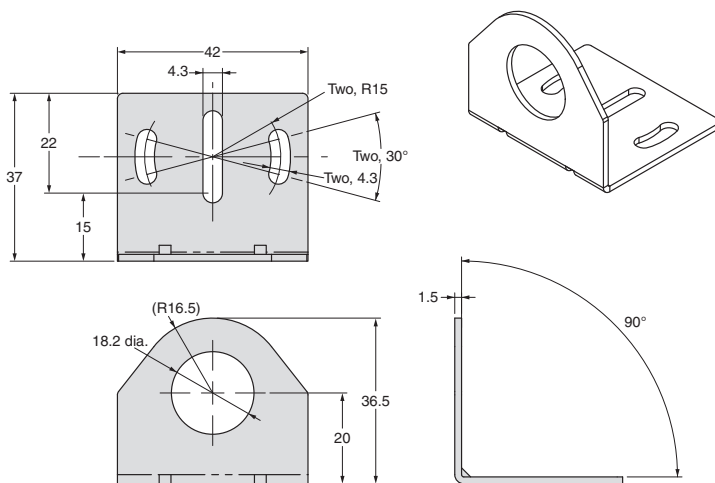

Flush mounting nut

E39-EL16

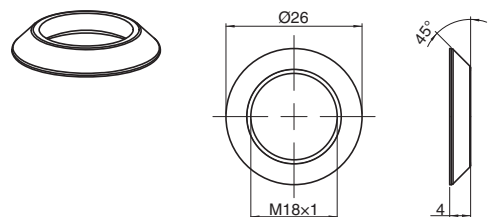

ALL DIMENSIONS SHOWN ARE IN MILLIMETERS.
 To convert millimeters into inches, multiply by 0.03937. To convert grams into ounces, multiply by 0.03527.