

Oil-resistant Photoelectric Sensors

E3ZR-C

Photoelectric Sensors That Withstand Cutting Oil to Reduce Failures Caused by Ingress of Cutting Oil

- Fluororesin cables that strongly resist cutting oil.
- Sealing methods that prevent gaps at joints block the ingress of cutting oil.
- IP67G * degree of protection (JIS C 0920 Annex 1).

 Refer to *Safety Precautions* on page 7.

*The IP67G is the degree of protection which is defined according to the JIS (Japanese Industrial Standards). The IP67 indicates the same level of protection as defined by the IEC, and the G indicates that a device has resistance to oil.



For the most recent information on models that have been certified for safety standards, refer to your OMRON website.

Features

Fluororesin Outer Cable Sheath

Fluororesin, which provides superior resistance to corrosion, is used for the outer cable sheath to suppress cable swelling and deterioration and prevent the ingress of cutting oil into the PCB inside the Sensor.



New Rubber Material Combining HNBR and Fluororubber Provides Superior Resistance to Oil

This new rubber material has been used in all vital seals to prevent the ingress of cutting oils.

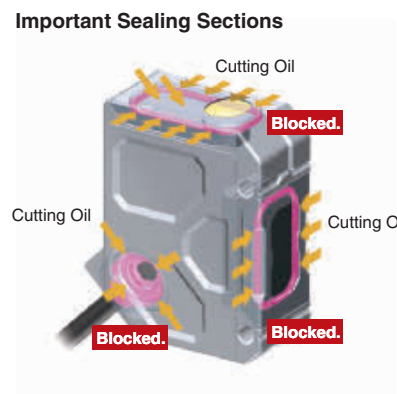

Method for Complete Sealing without Adhesive Joints between Metal Parts

Gaps are sealed by fusing the metal case and cover with a laser beam.

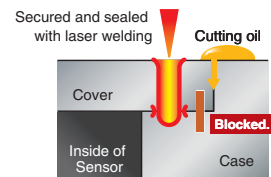

Joints between Metal and Non-metal Parts

Securing the metal case and lens cover with laser welding makes the compressed O-ring seal the gap.

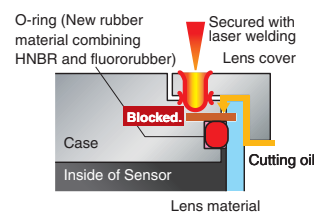

Applications

Engine Block Passage Detection

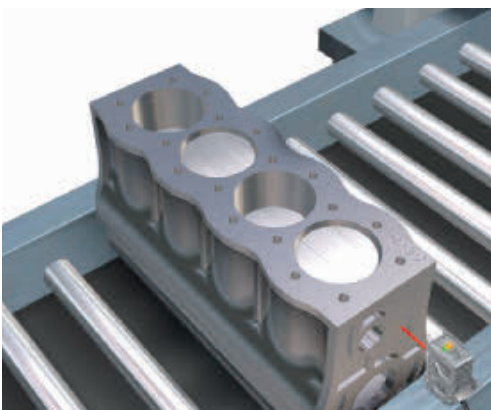

Metal Workpiece Detection

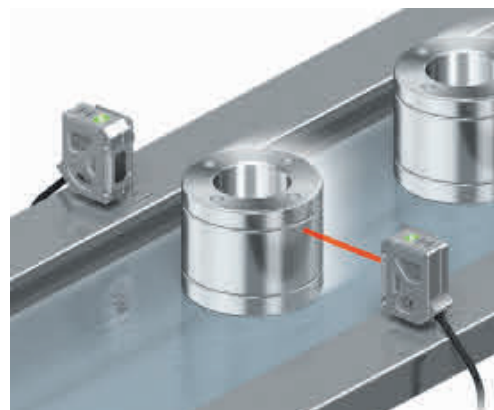





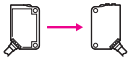

E3ZR-C

Ordering Information

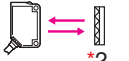
Sensors [Refer to *Dimensions* on page 9.]

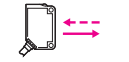
 Red light

Sensing method	Appearance	Connection method	Sensing distance	Operation mode	Model	
					NPN output	PNP output
Through-beam (Emitter + Receiver) *1		Pre-wired (2 m) *4	 30 m	Light ON	E3ZR-CT61L 2M Emitter E3ZR-CT61L-L 2M Receiver E3ZR-CT61L-D 2M	E3ZR-CT81L 2M Emitter E3ZR-CT81L-L 2M Receiver E3ZR-CT81L-D 2M
		M12 Smartclick pre-wired connector (0.3 m)			E3ZR-CT61L-M1TJ 0.3M Emitter E3ZR-CT61L-L-M1TJ 0.3M Receiver E3ZR-CT61L-D-M1TJ 0.3M	E3ZR-CT81L-M1TJ 0.3M Emitter E3ZR-CT81L-L-M1TJ 0.3M Receiver E3ZR-CT81L-D-M1TJ 0.3M
		Pre-wired (2 m) *4		Dark ON	E3ZR-CT61D 2M Emitter E3ZR-CT61D-L 2M Receiver E3ZR-CT61D-D 2M	E3ZR-CT81D 2M Emitter E3ZR-CT81D-L 2M Receiver E3ZR-CT81D-D 2M
		M12 Smartclick pre-wired connector (0.3 m)			E3ZR-CT61D-M1TJ 0.3M Emitter E3ZR-CT61D-L-M1TJ 0.3M Receiver E3ZR-CT61D-D-M1TJ 0.3M	E3ZR-CT81D-M1TJ 0.3M Emitter E3ZR-CT81D-L-M1TJ 0.3M Receiver E3ZR-CT81D-D-M1TJ 0.3M
Retro-reflective with MSR function		Pre-wired (2 m) *4	 2.5 m *3 (100 mm) <small>(When using E39-R1R Oil-resistant Reflector)</small>	Light ON	E3ZR-CR61L 2M	E3ZR-CR81L 2M
		M12 Smartclick pre-wired connector (0.3 m)			E3ZR-CR61L-M1TJ 0.3M	E3ZR-CR81L-M1TJ 0.3M
		Pre-wired (2 m) *4		Dark ON	E3ZR-CR61D 2M	E3ZR-CR81D 2M
		M12 Smartclick pre-wired connector (0.3 m)			E3ZR-CR61D-M1TJ 0.3M	E3ZR-CR81D-M1TJ 0.3M
Diffuse-reflective		Pre-wired (2 m) *4	 0.5 m	Light ON	E3ZR-CD61L 2M	E3ZR-CD81L 2M
		M12 Smartclick pre-wired connector (0.3 m)			E3ZR-CD61L-M1TJ 0.3M	E3ZR-CD81L-M1TJ 0.3M
		Pre-wired (2 m) *4		Dark ON	E3ZR-CD61D 2M	E3ZR-CD81D 2M
		M12 Smartclick pre-wired connector (0.3 m)			E3ZR-CD61D-M1TJ 0.3M	E3ZR-CD81D-M1TJ 0.3M

*1. Through-beam Sensors are sold in sets that include both the Emitter and Receiver. An order for the Emitter or Receiver alone cannot be accepted.

*2. The Reflector is sold separately. Select the Reflector model most suited to the application.

*3. Values in parentheses indicate the minimum required distance between the Sensor and Reflector.

*4. Models with 5-m cable length are also available with "5M" suffix. (Example: E3ZR-CT61L 5M)

Accessories (Sold Separately)



Sensor I/O Connectors (M12, Sockets on One Cable End)

(Models for Pre-wired Connectors) A Sensor I/O Connector is not provided with the Sensor. It must be ordered separately as required.

Appearance	Cable diameter (mm)	Cable length	Sensor I/O Connector model number	Applicable Photoelectric Sensor model number
	4 dia.	2 m	XS5FR-D423-D80-RB1	E3ZR-C□□1□-M1TJ
		5 m	XS5FR-D423-G80-RB1	
		10 m	XS5FR-D423-J80-RB1	

Note: Refer to the XS5□R on page 51 for connector details and for information on cables with connectors on both ends.

Mounting Brackets A Mounting Bracket is not provided with the Sensor. Order a Mounting Bracket separately if required.

Appearance	Model (material)	Quantity	Remarks
	E39-L153 (SUS304)	1	Mounting Brackets
	E39-L104 (SUS304)	1	
	E39-L98 (SUS304)	1	Metal Protective Cover Bracket

Note: 1. When using Through-beam models, order one bracket for the Receiver and one for the Emitter.
2. Refer to *Mounting Brackets on E39-L/E39-S/E39-R* on your OMRON website for details.

Reflector (A Reflector is required for each Retro-reflective Sensor: A Reflector is not provided with the Sensor. Be sure to order a Reflector.)

Name	E3ZM-CR sensing distance		Model	Quantity	Remarks
	Rated value	Reference value			
Oil-resistant Reflector	2.5 m (100 mm) *	---	E39-R1R	1	<ul style="list-style-type: none"> · Reflectors are not provided with Retro-reflective models. · The MSR function is enabled.

Note: Refer to *Reflectors on E39-L/E39-S/E39-R* on your OMRON website for details.
*Values in parentheses indicate the minimum required distance between the Sensor and Reflector.

E3ZR-C

Ratings and Specifications

Sensors

Model Item	Sensing method	Through-beam	Retro-reflective with MSR function	Diffuse-reflective
	NPN output	E3ZR-CT61□ (-M1TJ)	E3ZR-CR61□ (-M1TJ)	E3ZR-CD61□ (-M1TJ)
	PNP output	E3ZR-CT81□ (-M1TJ)	E3ZR-CR81□ (-M1TJ)	E3ZR-CD81□ (-M1TJ)
Sensing distance		30 m	2.5 m [100 mm] *1 (Using E39-R1R)	0.5 m (White paper 300 × 300 mm)
Standard sensing object		Opaque: 12-mm dia. min.	Opaque: 75-mm dia. min.	---
Differential travel		---		20% of sensing distance max.
Directional angle		Emitter, Receiver: 3° to 15° (Distance between emitter and receiver. Rated sensing distance)	Sensor: 2° to 10° Reflector: 30° (Distance to Reflector. Rated sensing distance)	---
Light source (wavelength)		Red LED (624 nm)	Red LED (660 nm)	Red LED (624 nm)
Power supply voltage		12 to 24 VDC ±10%, ripple (p-p) 10% max.		
Current consumption		35 mA max. (Emitter 15 mA max., Receiver 20 mA max.)	30 mA max.	
Control output		Output power supply voltage: 26.4 VDC max., Output current: 100 mA max. (Residual voltage: 2 V max.) Open-collector output (NPN/PNP output depending on model)		
Protection circuits		Reversed power supply polarity protection, output short-circuit protection, and reversed output polarity protection	Reversed power supply polarity protection, output short-circuit protection, reversed output polarity protection, and mutual interference prevention function (with up to two Units)	
Response time		Operate or reset: 1 ms max.		
Sensitivity adjustment		None		
Ambient illumination (Receiver side)		Incandescent lamp: 5,000 lx max., Sunlight: 10,000 lx max.		
Ambient temperature range		Operating: -25 to 55°C, Storage: -40 to 70°C (with no icing or condensation)		
Ambient humidity range		Operating: 35% to 85%, Storage: 35% to 95% (with no condensation)		
Insulation resistance		20 MΩ min. at 500 VDC		
Dielectric strength		1,000 VAC, 50/60 Hz for 1 min		
Vibration resistance		Destruction: 10 to 55 Hz, 1.5-mm double amplitude for 2 hours each in X, Y, and Z directions		
Shock resistance		Destruction: 1,000 m/s ² 3 times each in X, Y, and Z directions		
Degree of protection		IP67 (IEC 60529) and IP67G *2 (JIS C 0920 Annex 1) Passed OMRON's Oil-resistant Component Evaluation Standards *3 (Cutting oil type: specified in JIS K 2241:2000; Temperature: 35°C max.)		
Connection method		Pre-wired (standard length: 2 m), -M1TJ: Pre-wired connector (standard length: 0.3 m)		
Indicators		Operation indicator (orange) and stability indicator (green) (The Emitter has only a power indicator (green).)		
Weight (packed state)	Pre-wired models	Approx. 200 g	Approx. 100 g	
	Pre-wired connector	Approx. 140 g	Approx. 70 g	
Housing material		SUS316L		
Cable material		Fluororesin		
Lens material		Methacrylate resin (Oil-resistant high molecular weight type)		
Indicator material		Polyetherimide resin		
Accessories		Instruction manual		

*1. Values in parentheses indicate the minimum required distance between the Sensor and Reflector.

*2. The IP67G is the degree of protection which is defined according to the JIS (Japanese Industrial Standards).

The IP67 indicates the same level of protection as defined by the IEC, and the G indicates that a device has resistance to oil.

*3. The Oil-resistant Component Evaluation Standards are OMRON's own durability evaluation standards.

The Pre-wired Connector Model meets the degree of protection when it is correctly connected with an XS5□R Oil-resistant Connector.

The degree of protection is not satisfied with the part where there is no XS5FR Oil-resistant Connector connected and cable wires are uncovered.

And as for the Pre-wired Models, the degree of protection is not satisfied with the part where cable wires are uncovered.

Accessories (Sold Separately)

Reflector

Item	Name	Oil-resistant Reflector
	Model	E39-R1R
Directional angle	30° min.	
Ambient temperature range	Operating: -25 to 55°C, Storage: -40 to 70°C (with no icing or condensation)	
Ambient humidity range	Operating: 35% to 85%, Storage: 35% to 95% (with no condensation)	
Degree of protection	IP67 (IEC 60529) and IP67G *1 (JIS C 0920 Annex 1) Passed OMRON's Oil-resistant Component Evaluation Standards *2 (Cutting oil type: specified in JIS K 2241:2000, Temperature: 35°C max.)	

*1. The IP67G is the degree of protection which is defined according to the JIS (Japanese Industrial Standards).

The IP67 indicates the same level of protection as defined by the IEC, and the G indicates that a device has resistance to oil.

*2. The Oil-resistant Component Evaluation Standards are OMRON's own durability evaluation standards.

Engineering Data (Reference Value)

Parallel Operating Range

Through-beam Models

E3ZR-CT□1□

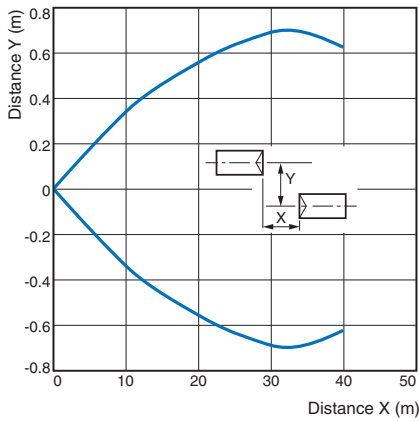

Retro-reflective Models

E3ZR-CR□1□

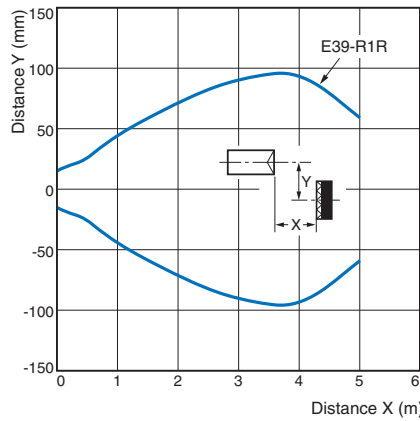

Operating Range

Diffuse-reflective Models

E3ZR-CD□1□

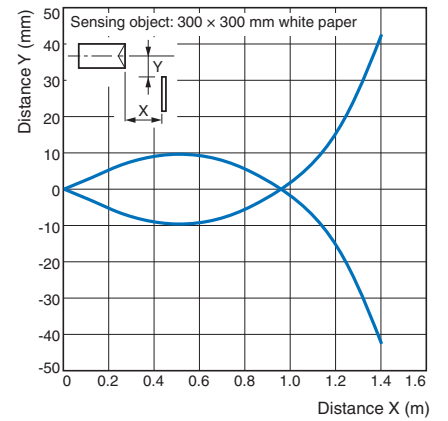

Excess Gain vs. Distance

Through-beam Models

E3ZR-CT□1□

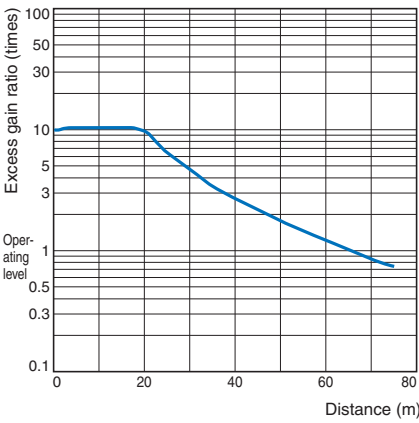

Retro-reflective Models

E3ZR-CR□1□

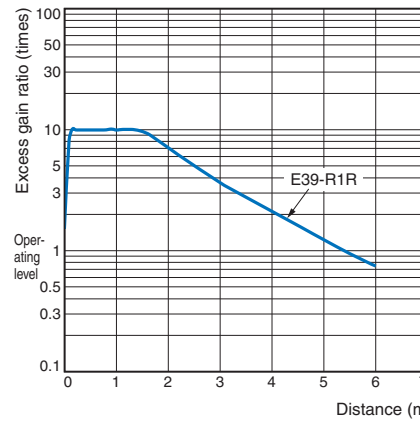

Diffuse-reflective Models

E3ZR-CD□1□

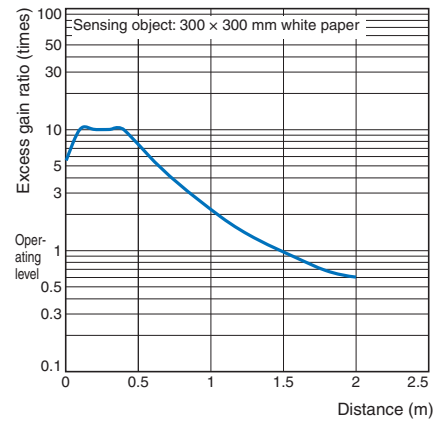

Sensing Object Size vs. Distance

Diffuse-reflective Models

E3ZR-CD□1□

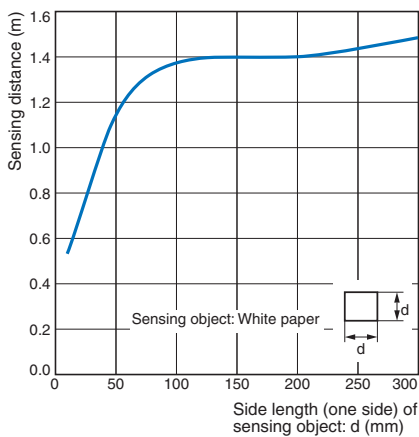

E3ZR-C

I/O Circuit Diagrams

NPN Output

Model	Operation mode	Timing charts	Output circuit
E3ZR-CT61L E3ZR-CR61L E3ZR-CD61L	Light ON		
E3ZR-CT61D E3ZR-CR61D E3ZR-CD61D	Dark ON		

PNP Output

Model	Operation mode	Timing charts	Output circuit
E3ZR-CT81L E3ZR-CR81L E3ZR-CD81L	Light ON		
E3ZR-CT81D E3ZR-CR81D E3ZR-CD81D	Dark ON		

Emitter (Either NPN or PNP Output)

Model	Circuit
E3ZR-CT61□ E3ZR-CT81□	

Connector Pin Arrangement

M12 Pre-wired Connector

M12 Connector Pin Arrangement



Plugs (Sensor I/O Connectors)

M12 Smartclick Connector

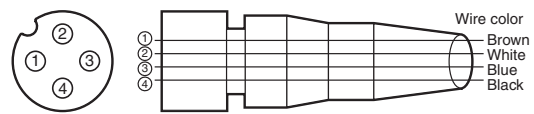

XS5FR-D423-D80-RB1 (2 m)
XS5FR-D423-G80-RB1 (5 m)
XS5FR-D423-J80-RB1 (10 m)

Nomenclature

Sensors with Sensitivity Adjuster and Operation Selector

Through-beam Models

E3ZR-CT□1□-D (Receiver)

Retro-reflective Models

E3ZR-CR□1□

Diffuse-reflective Models



E3ZR-CD□1□







Safety Precautions

Be sure to read the precautions for all models in the website at: <http://www.ia.omron.com/>.

Warning Indications

 WARNING	Warning level Indicates a potentially hazardous situation which, if not avoided, will result in minor or moderate injury, or may result in serious injury or death. Additionally there may be significant property damage.
 CAUTION	Caution level Indicates a potentially hazardous situation which, if not avoided, may result in minor or moderate injury or in property damage.
Precautions for Safe Use	Supplementary comments on what to do or avoid doing, to use the product safely.
Precautions for Correct Use	Supplementary comments on what to do or avoid doing, to prevent failure to operate, malfunction or undesirable effect on product performance.

Meaning of Product Safety Symbols

	General prohibition Indicates the instructions of unspecified prohibited action.
	Caution, fire Indicates the possibility of fires under specific conditions.
	Caution, explosion Indicates the possibility of explosion under specific conditions.
	General caution Indicates unspecified general alert.
	Caution, high temperature Indicates the possibility of injuries by high temperature under specific conditions.

WARNING

This product is not designed or rated for ensuring safety of persons either directly or indirectly. Do not use it for such purposes.



CAUTION

Do not use it exceeding the rated voltage. There is a possibility of failure and fire.



Risk of explosion. Do not connect the product to an AC power supply.



Do not jet the high pressure water concentrating on one place when washing the product, because it might damage of parts and deteriorate the degree of protection.



Do not use this product under ambient conditions that exceed the ratings. High-temperature environments may result in burn injury.



Precautions for Safe Use

The following precautions must be observed to ensure safe operation.

- (1) Operating Environment
 1. Do not use the product in an environment where flammable or explosive gas is present.
 2. Do not use the product in environments subject to cleaners and disinfectants. They may reduce the degree of protection.
- (2) Output short-circuit

Please do not connect a output short-circuit. Please do not throw the current that exceeds ratings into the control output. When an excessive electric current was thrown, the output short-circuit protection function installed, but it'll be the cause which breaks down.
- (3) Low-temperature Environments

Do not touch the metal surface with your bare hands when the temperature is low.
Touching the surface may result in a cold burn.
- (4) Modifications

Do not attempt to disassemble, repair, or modify the product.
- (5) Protective structure

Do not use the product with degrade protective structure such as swelling and crack in housing and/or sealing components. Otherwise cutting oil or other substance may enter the product, resulting in a risk of corruption or burning.

Precautions for Correct Use

- (1) Do not install the product in the following locations.
 1. In the place exposed to the direct sunlight.
 2. In the place where humidity is high and condensation may occur.
 3. In the place where corrosive gas exists.
 4. In the place where vibration or shock is directly transmitted to the product.
- (2) Connection and Mounting
 - Be sure that before making supply the supply voltage is less than the maximum rated supply voltage. (26.4V DC)
 - If the Sensor wiring is placed in the same conduits or ducts as high-voltage or high-power lines, inductive noise may cause malfunction or damage. Wire the cables separately or use a shielded cable.
 - For extending cable, use a cable 0.3 mm² min. and 100 m max. in length.
 - Do not pull the cable strongly.
 - Excessive force (hitting by hammer, etc.) should not be put on the Sensor because it may damage its water-resistance and oil-resistance characteristic.
 - Mount the Sensor either using the bracket (sold separately) or on a flat surface.
 - Use M3 screws to mount the Sensor.
 - Use tightening torque 0.5 N·m max.
 - Be sure to turn OFF the power supply before inserting or removing the connector.

Mounting Diagram

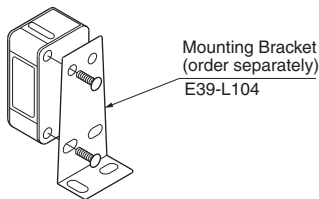

- (3) Connecting Connectors
 - Be sure to hold the connector cover when inserting or removing the connector.
 - Be sure to tighten the connector lock by hand; do not use pliers or other tools.
 - If the tightening is insufficient, the degree of protection will not be maintained and the Sensor may become loose due to vibration.
- (4) Pre-wired Connector Model
 - The E3ZR-C can be used in conditions of cutting oil use described in the specifications.
 - The oil resistance may not be ensured when the products are not mated to XS5□R Connectors, so use the products correctly.
 - When mating the products to XS2 or other M12 Connectors, tighten the lock to a torque of 0.39 to 0.49 N·m.
- (5) Oil resistance

The following conditions shall be observed if you use the product under an environment using cutting oil that may affect product's life and/or performance.

 - Usage under the cutting oil condition designated by the specification
 - Usage under the cutting oil dilution ratio recommended by its manufacturer
 - Usage in oil or water is prohibited

Impact on the product life may differ depending on the oil you use.

Before using the cutting oil, make sure that it should not cause deterioration or degradation of sealing components.

- (6) Water resistance

This product fit in with IP67/67G, but this product isn't perfect waterproofing.

Avoid using the product in the water or locations subject to water drops.
- (7) Power supply

When using a commercially available switching regulator, be sure to ground the FG (Frame Ground) terminals.
- (8) Power supply reset time

The Sensor will begin sensing no later than 100 ms after the power is turned on.

If the load and the Sensor is connected to different power supply, the Sensor must be always turned on first.
- (9) Turning off the power supply

When turning off the power, output pulse may be generated. We recommend turning off the power supply of the load or load line first.
- (10) Overcurrent

External overcurrent protection of 1 A for AWG25 wire must be provided for cable protection.
- (11) Output short-circuit protection

If the output short-circuit occurs, the output will turn off. Check the wiring before turning ON the power supply again.

The output short-circuit protection will operate when the current flow reaches 1.8 times the rated load current.

When using a capacitive load, use an inrush current of 1.8 times the rated load current or lower.
- (12) Cleaning

Never use thinner or other solvents. Otherwise, the Sensor surface may be dissolved.
- (13) Disposing

Please process this product as industrial waste.

Dimensions

Tolerance class IT16 applies to dimensions in this data sheet unless otherwise specified.

Sensors

Through-beam Models*

Pre-wired Models

E3ZR-CT61□

E3ZR-CT81□

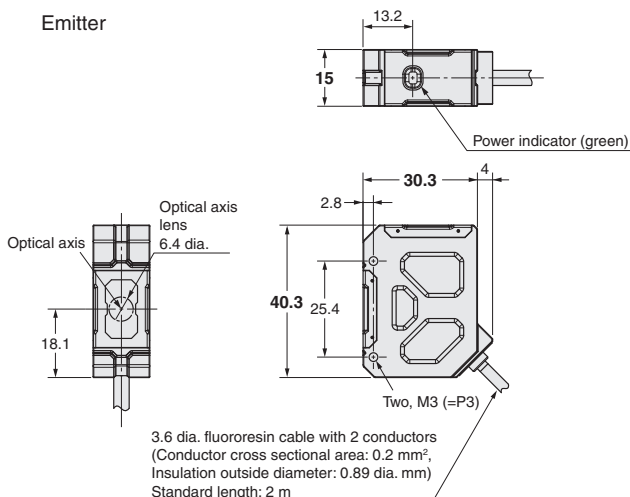

M12 Pre-wired Connector (E3ZR-C□□1□-M1TJ)

3.6 dia. fluororesin cable with 2 conductors
(Conductor cross sectional area: 0.2 mm²,
Insulation outside diameter: 0.89 dia. mm)
Standard length: 0.3 m

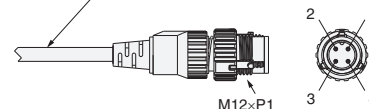

Terminal No.	Specifications
1	+V
2	---
3	0V
4	---

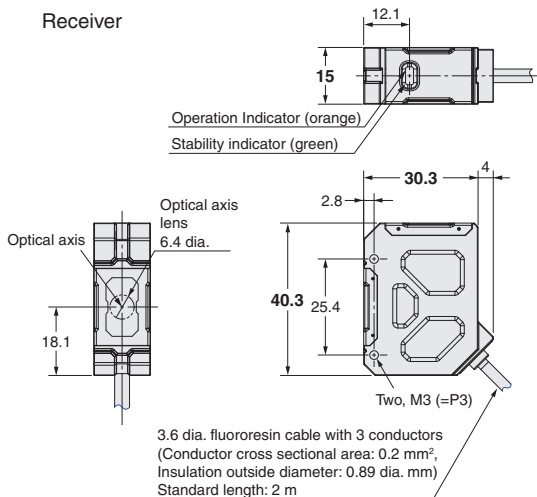

M12 Pre-wired Connector (E3ZR-C□□1□-M1TJ)

3.6 dia. fluororesin cable with 3 conductors
(Conductor cross sectional area: 0.2 mm²,
Insulation outside diameter: 0.89 dia. mm)
Standard length: 0.3 m

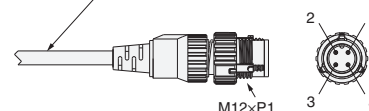

Terminal No.	Specifications
1	+V
2	---
3	0V
4	Output

Retro-reflective Models

Pre-wired Models

E3ZR-CR61□

E3ZR-CR81□

Diffuse-reflective Models

Pre-wired Models

E3ZR-CD61□

E3ZR-CD81□

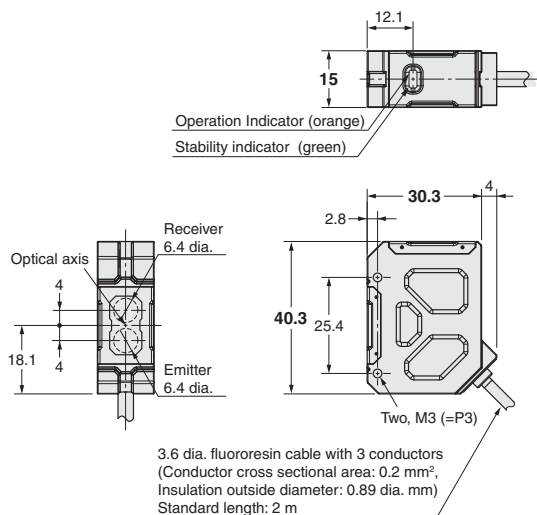

M12 Pre-wired Connector (E3ZR-C□□1□-M1TJ)

3.6 dia. fluororesin cable with 3 conductors
(Conductor cross sectional area: 0.2 mm²,
Insulation outside diameter: 0.89 dia. mm)
Standard length: 0.3 m

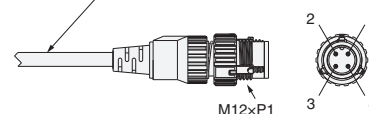

Terminal No.	Specifications
1	+V
2	---
3	0V
4	Output

*Models numbers for Through-beam Sensors (E3ZR-CT□□1□(-M1TJ)) are for sets that include both the Emitter and Receiver.

The model number of the Emitter is expressed by adding "-L" to the set model number (example: E3ZR-CT61L-L 2M), the model number of the Receiver, by adding "-D" (example: E3ZR-CT61L-D 2M.) Refer to *Ordering Information* to confirm model numbers for Emitters and Receivers.

Cable bend radius

