

Temperature Sensor E52

CSM_E52_DS_E_10_1

A Wide Variety of High-precision Temperature Sensors













- New and improved E52 temperature sensor series. Wide selection of sensors compatible with M3 screws
- Ideal for the thermal input devices of Temperature Controllers.
- Select from a wide variety of Temperature Sensors according to the temperature to be measured, location, and environment, and also according to the type and shape of the terminal.











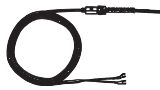

 Refer to *Safety Precautions for All Temperature Controllers*.

Ordering Information

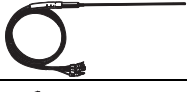
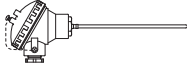
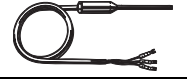
List of Models

Classification	Description	Model and appearance	Temperature range (See note 3.)	Element type	Conductor type	Class	Protective tubing material	Terminal type	Page	
General-purpose Models	Sheathed platinum resistance thermometer	E52-P□AY 	-196 C to 450 C	Pt100	3-conductor system	B	SUS316	Exposed lead wires	5	
		E52-P□C-N 					-200 C to 450 C	ASTM316L	Enclosed terminals	6
		E52-P□B-N 							Exposed terminals	
	Standard platinum resistance thermometer	E52-P□C-N 	0 C to 450 C				SUS316	Enclosed terminals	7	
	Sheathed thermocouple	E52-CA□AY E52-IC□AY 	E52-CA□B-N E52-IC□B-N 	0 C to 900 C	K (CA) J (IC)	Non-grounded type	2 (0.75)	ASTM316L	Exposed lead wires	9 to 12
									Exposed terminals	13
									Enclosed terminals	
Standard thermocouple		E52-CA□B-N E52-IC□B-N 	E52-CA□C-N E52-IC□C-N 	0 C to 900 C	K (CA) J (IC)	Non-grounded type	2 (0.75)	SUS316	Exposed terminals	14
									Enclosed terminals	15
									E52-PR□C-N 	0 C to 1,400 C
Low-cost Models	Low-cost platinum resistance thermometer	E52-P10AEY	-50 C to 250 C	Pt100	3-conductor system	B	SUS316 SUS304	Exposed lead wires	17	
		E52-P6DY								
		E52-P6FY								
	Low-cost thermocouple	E52-CA□ASY E52-IC□ASY 	E52-CA1DY E52-IC1DY 	0 C to 400 C	K (CA) J (IC)	Non-grounded type Grounded type	2 (0.75)	SUS316 SUS304	Exposed lead wires	18
										19
										20
										E52-CA6F-N E52-IC6F-N E52-CA6D-N E52-IC6D-N 

- Note:**
1. Exclusive models are provided on the following page.
 2. These tables provide general specifications only. Be sure to read the detailed specifications and precautions before use.
 3. The temperature range varies with the material, thickness, construction, and element type of the protective tubing.

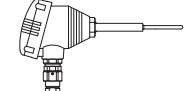
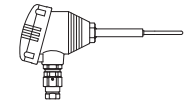
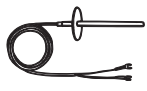
Classification	Description	Model and appearance	Temperature range (See note 3.)	Element type	Conductor type	Class	Protective tubing material	Terminal type	Page
Exclusive Models	Bayonet spring for molding machines	E52-CA2GVY E52-IC2GVY 	0 C to 350 C	K (CA) J (IC)	Grounded type	2 (0.75)	SUS304	Exposed lead wires	21
	Crimping terminals	E52-CA1GTY E52-IC1GTY 	0 C to 300 C						
	Used for measuring surface temperatures	E52-P2GSY 	-50 C to 250 C	Pt100	3-conductor system	B	SUS304		22
	Used for room temperature measurement	E52-P10GRY 	-50 C to 60 C						
	Double-element model	E52-CA20AY-7 	0 C to 900 C	K (CA)	Two non-grounded types	2 (0.75)	ASTM316L		25
		E52-P20AY-7 	-196 C to 250 C	Pt100	Two 3-conductor systems				
		E52-P20C-N-7 	-200 C to 450 C					Enclosed terminals	26
	Water-proof model	E52-P10GPY 	0 C to 70 C		3-conductor system		SUS304	Exposed lead wires	22
		E52-P5AY-40 	-50 C to 180 C				Fluoro-resin tubing		23
	Corrosion-resistant model	E52-P20AY-1 	-80 C to 180 C			2 (0.75)			
E52-CA20AY-1 		0 C to 180 C	K (CA)						
Silicone-covered lead wires	E52-CA1DY-40 	0 C to 300 C			2 (0.75)		SUS304		26
	E52-CA1GTY-14 	0 C to 200 C							
Explosion-proof model	E52-P□□C-N-6 	---	Pt100	3-conductor system	B	ASTM316L		Enclosed terminals	24
	E52-CA□□C-N-6 	---	K (CA)	Non-grounded type					
Thermistors	E52-THE5A E52-THE6F E52-THE6D 	-50 C to 300 C	Thermistor	Element-interchangeable thermistor	1	SUS304	Exposed lead wires	28	

- Note:**
1. General-purpose models and low-cost models are provided on the previous page.
 2. These tables provide general specifications only. Be sure to read the detailed specifications and precautions before use.
 3. The temperature range varies with the material, thickness, construction, and element type of the protective tubing.

■ Accessories

It is recommended that the following accessories be used for mounting Temperature Sensors.

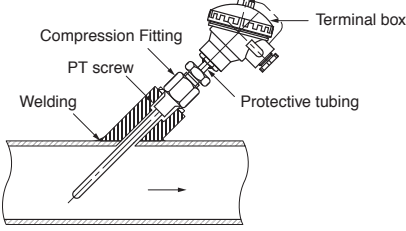
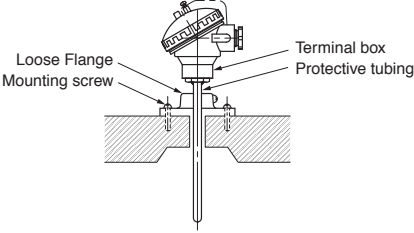
Accessory	Temperature range	Mounting example	Page
Compression Fitting	600 C max.	<p>Mounting with Compression Fitting</p>  <p>Note: The Compression Fitting is not of airtight construction. Do not use the Compression Fitting for applications in which the exposure of the sensing object will cause problems.</p>	29
Loose Flange	400 C max.	<p>Mounting with Loose Flange</p>  <p>Note:</p> <ol style="list-style-type: none"> 1. Use the Loose Flange in normal atmospheric pressure. The Loose Flange is not of airtight construction. 2. Use the Loose Flange at 400 C max. 3. Do not apply the Loose Flange to protective tubing diameters other than the applicable ones. 	

General-purpose Models

Model Number Legend

The type of resistance thermometer, protective tubing length, and lead length can be specified as shown below.

Platinum Resistance Thermometers

E52- $\overbrace{\square\square\square}^{1\ 2\ 3}$ D= $\overbrace{\square\square\square}^{4\ 5\ 6}$ M

1. Element type

P: Pt100

2. Protective tubing length (L)

Specify the length in centimeters within the following range:
Unit (cm)

E52- $\square\square$ AY

Diameter (D)	Length (L)
3.2	7 to 100
4.8	10 to 600
6.4	13 to 1,300

E52- $\square\square$ B-N

Diameter (D)	Length (L)
8	20 to 100

E52- $\square\square$ C-N

Diameter (D)	Length (L)
3.2	12 to 100
4.8	15 to 600
6.4	18 to 1,300
8	21 to 100
10	26 to 100

3. Terminal

AY: Exposed lead wires (Y-type crimp terminal for M3.5)

B-N: Exposed terminals

C-N: Enclosed terminals

Examples

Element: Pt100, protective tubing length: 420 mm, exposed leads, protective tubing dia.: 4.8 mm, heat resistive, lead length: 10 m
E52-P42AY D=4.8 NETU 10M

Sheathed Platinum Resistance Thermometers

Refer to *Model Number Legend* above for the Pt100.

Specifications

Element type	Pt100
Class	JIS class B
Sheath material	SUS316 (E52-P \square AY) ASTM316L (E52-P \square B-N, E52-P \square C-N)
Sheath outer diameter	3.2 dia., 4.8 dia., 6.4 dia., 8 dia
Conductor type	3-conductor system
Temperature range	-200 C to 450 C (in dry air)

4. Diameter

3.2: 3.2-mm dia. (Protective tubing construction: Sheathed)
E52- $\square\square$ AY and E52- $\square\square$ C-N only

4.8: 4.8-mm dia. (Protective tubing construction: Sheathed)
E52- $\square\square$ AY and E52- $\square\square$ C-N only

6.4: 6.4-mm dia. (Protective tubing construction: Sheathed)
E52- $\square\square$ AY and E52- $\square\square$ C-N only

8: 8-mm dia. (Protective tubing construction: Sheathed)
E52- $\square\square$ B-N and E52- $\square\square$ C-N only

10: 10-mm dia. (Protective tubing construction: Standard)
E52- $\square\square$ C-N only

5. Heat resistance

Code	Temperature range	Lead type
---	-20 C to 70 C Sleeve: 0 C to 70 C	Vinyl-covered
NETU	0 C to 180 C Sleeve: 0 C to 100 C	Glass-wool-covered, externally shielded with stainless

Specify for E52- $\square\square$ AY model only.

6. Lead length (M)

Specify the length in meters within the following range for the E52- $\square\square$ A only:

Range: 0.5, 1 to 100 m

Exposed-lead Models

E52-P□AY

Dimensions

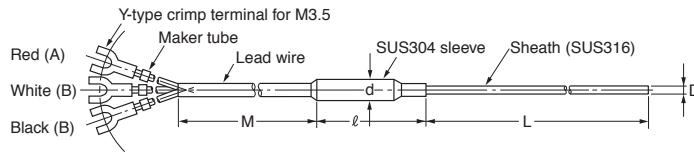

Unit (mm)

D	d	ℓ
3.2 dia.	8	40
4.8 dia.	8	40
6.4 dia.	8	40

Lead Wire

- Standard (-20 C to 70 C): Fully vinyl-covered with twelve 0.18-dia conductors (0.3 mm thick) and 4.8 mm in outer dia. The sleeve resists a temperature range between 0 C and 70 C.
- Heat Resistant (0 C to 180 C): Fully glass-wool-covered with thirty 0.12-dia. conductors (0.3 mm thick) externally shielded with stainless steel, 4 mm in outer dia. The sleeve resists a temperature range between 0 C and 100 C.
- Lead Wire Length (M): 1, 2, 4, or 8 m

Model Information

Custom-made models are available on request. Refer to page 4 for details.

Terminal type	Protective tubing diameter D (mm)	Protective tubing length L (cm)	Lead wire type	Lead wire length M (m)			
				1	2	4	8
				Model			
Exposed-lead Models	3.2 dia.	15	Standard	E52-P15AY D=3.2 1M	E52-P15AY D=3.2 2M	E52-P15AY D=3.2 4M	E52-P15AY D=3.2 8M
			Heat resistive	E52-P15AY D=3.2 NETU 1M	E52-P15AY D=3.2 NETU 2M	E52-P15AY D=3.2 NETU 4M	E52-P15AY D=3.2 NETU 8M
		20	Standard	E52-P20AY D=3.2 1M	E52-P20AY D=3.2 2M	E52-P20AY D=3.2 4M	E52-P20AY D=3.2 8M
			Heat resistive	E52-P20AY D=3.2 NETU 1M	E52-P20AY D=3.2 NETU 2M	E52-P20AY D=3.2 NETU 4M	E52-P20AY D=3.2 NETU 8M
		35	Standard	E52-P35AY D=3.2 1M	E52-P35AY D=3.2 2M	E52-P35AY D=3.2 4M	E52-P35AY D=3.2 8M
			Heat resistive	E52-P35AY D=3.2 NETU 1M	E52-P35AY D=3.2 NETU 2M	E52-P35AY D=3.2 NETU 4M	E52-P35AY D=3.2 NETU 8M
	4.8 dia.	20	Standard	E52-P20AY D=4.8 1M	E52-P20AY D=4.8 2M	E52-P20AY D=4.8 4M	E52-P20AY D=4.8 8M
			Heat resistive	E52-P20AY D=4.8 NETU 1M	E52-P20AY D=4.8 NETU 2M	E52-P20AY D=4.8 NETU 4M	E52-P20AY D=4.8 NETU 8M
		35	Standard	E52-P35AY D=4.8 1M	E52-P35AY D=4.8 2M	E52-P35AY D=4.8 4M	E52-P35AY D=4.8 8M
			Heat resistive	E52-P35AY D=4.8 NETU 1M	E52-P35AY D=4.8 NETU 2M	E52-P35AY D=4.8 NETU 4M	E52-P35AY D=4.8 NETU 8M
		50	Standard	E52-P50AY D=4.8 1M	E52-P50AY D=4.8 2M	E52-P50AY D=4.8 4M	E52-P50AY D=4.8 8M
			Heat resistive	E52-P50AY D=4.8 NETU 1M	E52-P50AY D=4.8 NETU 2M	E52-P50AY D=4.8 NETU 4M	E52-P50AY D=4.8 NETU 8M
6.4 dia.	20	Standard	E52-P20AY D=6.4 1M	E52-P20AY D=6.4 2M	E52-P20AY D=6.4 4M	E52-P20AY D=6.4 8M	
		Heat resistive	E52-P20AY D=6.4 NETU 1M	E52-P20AY D=6.4 NETU 2M	E52-P20AY D=6.4 NETU 4M	E52-P20AY D=6.4 NETU 8M	
	35	Standard	E52-P35AY D=6.4 1M	E52-P35AY D=6.4 2M	E52-P35AY D=6.4 4M	E52-P35AY D=6.4 8M	
		Heat resistive	E52-P35AY D=6.4 NETU 1M	E52-P35AY D=6.4 NETU 2M	E52-P35AY D=6.4 NETU 4M	E52-P35AY D=6.4 NETU 8M	
	50	Standard	E52-P50AY D=6.4 1M	E52-P50AY D=6.4 2M	E52-P50AY D=6.4 4M	E52-P50AY D=6.4 8M	
		Heat resistive	E52-P50AY D=6.4 NETU 1M	E52-P50AY D=6.4 NETU 2M	E52-P50AY D=6.4 NETU 4M	E52-P50AY D=6.4 NETU 8M	

Enclosed-terminal Models

E52-P□C-N

Dimensions

Dimensions are given in millimeters, except for the length (L), which is provided in centimeters.

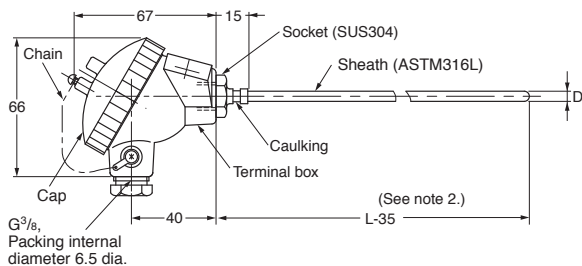

Use wiring terminals that fit M3 screws.

Terminal box: The permissible temperature is 0 C to 90 C.

Note: 1. The terminals in the cap indicate polarity (A, B, b).

2. The length L is in centimeters, but "35" is 35 millimeters.

Therefore, for the E52-P35C-N: L = 35 (cm), the sheath length $L - 35 = 350 - 35 = 315$ mm.

Model Information

Custom-made models are available on request. Refer to page 4 for details.

Terminal type	Protective tubing length L (cm)	Protective tubing diameter D (mm)			
		3.2 dia.	4.8 dia.	6.4 dia.	8 dia.
Model					
Enclosed-terminal Models	20	E52-P20C-N D=3.2	E52-P20C-N D=4.8	E52-P20C-N D=6.4	E52-P20C-N D=8
	35	E52-P35C-N D=3.2	E52-P35C-N D=4.8	E52-P35C-N D=6.4	E52-P35C-N D=8
	50	E52-P50C-N D=3.2	E52-P50C-N D=4.8	E52-P50C-N D=6.4	E52-P50C-N D=8
	75	---	E52-P75C-N D=4.8	E52-P75C-N D=6.4	---

Exposed-terminal Models

E52-P□B-N

Dimensions

Dimensions are given in millimeters, except for the length (L), which is provided in centimeters.

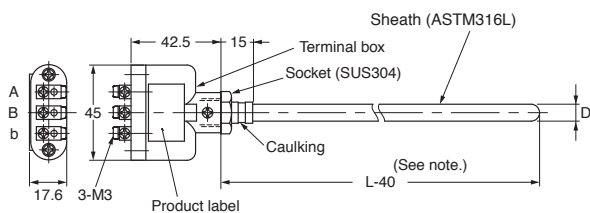

Terminal box: The permissible temperature is 0 C to 100 C.

Model Information

Custom-made models are available on request. Refer to page 4 for details

Terminal type	Protective tubing length L (cm)	Protective tubing diameter D (mm)
		8 dia.
Model		
Exposed-terminal Models	20	E52-P20B-N D=8
	35	E52-P35B-N D=8
	50	E52-P50B-N D=8

Note: The length L is in centimeters, but "40" is 40 millimeters.

Therefore, for the E52-P35B-N: L = 35 (cm), the sheath length $L - 40 = 350 - 40 = 310$ mm.

Standard Platinum Resistance Thermometers

Refer to *Model Number Legend* on page 4 for the Pt100.

Specifications

Element type	Pt100
Class	JIS class B (See note 2.)
Protective tubing material	SUS316
Conductor type	3-conductor system
Temperature range	0 C to 450 C (in dry air)

- Note:**
1. Use the sheathed platinum resistance thermometer if condensation is likely to result.
 2. Be sure that the thermometer is free of vibration or shock if high temperatures are measured.

Enclosed-terminal Models

E52-P□C-N

Dimensions

Dimensions are given in millimeters, except for the length (L), which is provided in centimeters.

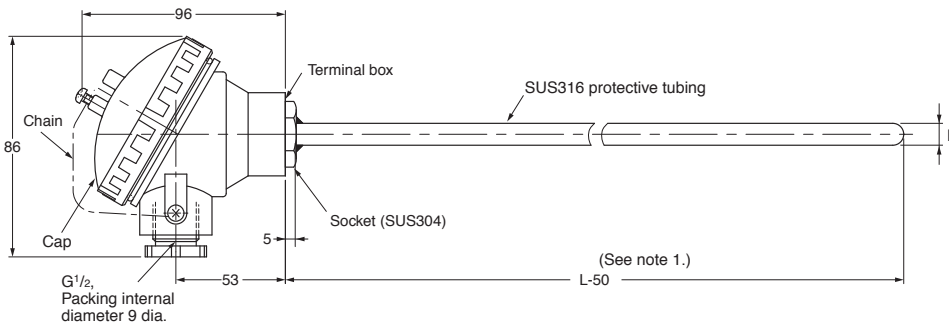

- Note:**
1. The length L is in centimeters, but "50" is 50 millimeters. Therefore, for the E52-P75C-N: $L = 75$ (cm), the protective tubing length $L - 50 = 750 - 50 = 700$ mm.

Terminal box: The permissible temperature is 0 C to 90 C.

Note: The terminals in the cap indicate polarity (A, B, B).

Model Information

Custom-made models are available on request. Refer to page 4 for details.

Terminal type	Protective tubing length L (cm)	Protective tubing diameter D (mm)
		10 dia. Model
Enclosed-terminal Models	35	E52-P35C-N D=10
	50	E52-P50C-N D=10
	75	E52-P75C-N D=10
	100	E52-P100C-N D=10

■ Model Number Legend

The type of resistance thermometer, protective tubing length, and lead length can be specified as shown below.

Thermocouples

E52-□□□□ D=□□□□M□
 1 2 3 4 5 6 7

1. Element type

CA:K

IC: J

PR:R

2. Protective tubing length (L)

Specify the length in centimeters in the following range: Unit (cm)

E52-□□AY (Exposed-lead Model)

Diameter (D)	Length (L)
1	2 to 200
1.6	3 to 500
3.2	5 to 2,000
4.8	8 to 2,300
6.4	10 to 1,200
8	12 to 1,000

E52-□□B-N and E52-□□C-N (except E52-PR□C-N)

Diameter (D)	Length (L)
3.2	11 to 2,000
4.8	14 to 2,300
6.4	16 to 1,200
8.0	18 to 1,000
10	21 to 126
12	24 to 126
15	29 to 156
22	39 to 206

E52-PR□C-N

Diameter (D)	Length (L)
15	50, 75, 100

3. Terminal

AY: Exposed lead wires (Y-type crimp terminal for M3.5)
 (element type: K, J)

B-N: Exposed terminals (element type: K, J)

C-N: Enclosed terminals (element type: K, J, R)

Examples

Element: K; protective tubing length: 420 mm, exposed leads, protective tubing dia.: 4.8 mm, heat resistive, lead length: 10 m
 E52-CA42AY D=4.8 NETU 10M

Element: J; protective tubing length: 360 mm, enclosed terminals, protective tubing dia.: 3.2
 E52-IC36C-N D=3.2

4. Diameter

Specify the protective tubing material according to the table.

Code	Diameter (D)	Protective tubing construction	Protective tubing material
1	1 mm	Sheathed	ASTM316L
1.6	1.6 mm	Sheathed	ASTM316L
3.2	3.2 mm	Sheathed	ASTM316L
4.8	4.8 mm	Sheathed	ASTM316L
6.4	6.4 mm	Sheathed	ASTM316L
8	8 mm	Sheathed	ASTM316L
10	10 mm	Standard	SUS316, SUS310S
12	12 mm	Standard	SUS316, SUS310S
15	15 mm	Standard	SUS316, SUS310S
22	22 mm	Standard	SUS316, SUS310S
17	17 mm	Standard	PT1, PT0

5. Heat resistance

Specify this item for the exposed-lead models only.

Code	Temperature range	Lead type
---	-20 C to 70 C Sleeve: 0 C to 70 C	Vinyl-covered
NETU	0 C to 150 C Sleeve: 0 C to 100 C	Glass-wool-covered with external shield of stainless

6. Lead length (M)

Specify the length in meters in the following range for the E52-□□A only.

Range: 1 to 100 m

7. Protective tubing material

Code	Protective tubing material	Element type
---	ASTM316L	K, J
SUS310S	SUS310S	K, D = 10 to 22
PT1	JIS ceramic Cat.1	R
PT0	JIS special ceramic	R

Sheathed Thermocouples

Specifications

Element type	K (CA), J(IC)
Class	JIS class 2 (0.75)
Thermal contact	Non-grounded type
Sheath material	CA: ASTM316L
	IC: ASTM316L

Permissible Temperature in Dry Air

D	Element wire	
	K (CA) ASTM316L	J (IC) ASTM316L
1 dia.	650 C	450 C
1.6 dia.	650 C	450 C
3.2 dia.	750 C	650 C
4.8 dia.	800 C	750 C
6.4 dia.	800 C	750 C
8.0 dia.	900 C	750 C

Note: For details on the permissible temperature, refer to page D-5 of Introduction of Temperature Controllers (Cat. No. H900).

Exposed-lead Models

E52-CA□AY

Dimensions

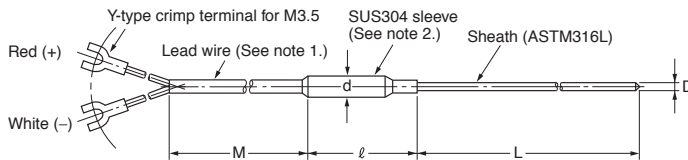

Note: 1. Lead Wire (Compensating Conductor)

- Standard (-20 C to 70 C): Fully vinyl-covered with seven 0.3-dia. conductors (0.5 mm thick) and external dimensions of 2.4 × 4.1.
- Heat Resistant (0 C to 150 C): Fully glass-wool-covered with seven 0.3-dia. conductors (0.5 mm thick) with external shield of stainless steel and external dimensions of 2.8 × 4.6. The heat-resistant lead wires cannot be used in locations exposed to water or other liquids.
- Lead Wire Length (M): 1, 2, 4, or 8 m

- The sleeve resists temperatures ranging between -20 C and 70 C for standard models and 0 C and 100 C for heat-resistant models.

Unit (mm)

D	d	l
1 dia.	8	55
1.6 dia.	8	55
3.2 dia.	8	55
4.8 dia.	8	55
6.4 dia.	11	55
8 dia.	11	55

Permissible Temperature in Dry Air

D	Element wire	
	K (CA) ASTM316L	
1 dia.	650 C	
1.6 dia.	650 C	
3.2 dia.	750 C	
4.8 dia.	800 C	
6.4 dia.	800 C	
8.0 dia.	900 C	

K (CA) Model Information (E52-CA□AY)

Model Information

Custom-made models are available on request. Refer to *Model Number Legend* on page 8 for details.

Terminal type	Protective tubing diameter D (mm)	Protective tubing length L (cm)	Lead wire type	Lead wire length M (m)			
				1	2	4	8
				Model			
Exposed-lead Models	1 dia.	15	Standard	E52-CA15AY D=1 1M	E52-CA15AY D=1 2M	E52-CA15AY D=1 4M	E52-CA15AY D=1 8M
			Heat resistive	E52-CA15AY D=1 NETU 1M	E52-CA15AY D=1 NETU 2M	E52-CA15AY D=1 NETU 4M	E52-CA15AY D=1 NETU 8M
		20	Standard	E52-CA20AY D=1 1M	E52-CA20AY D=1 2M	E52-CA20AY D=1 4M	E52-CA20AY D=1 8M
			Heat resistive	E52-CA20AY D=1 NETU 1M	E52-CA20AY D=1 NETU 2M	E52-CA20AY D=1 NETU 4M	E52-CA20AY D=1 NETU 8M
		35	Standard	E52-CA35AY D=1 1M	E52-CA35AY D=1 2M	E52-CA35AY D=1 4M	E52-CA35AY D=1 8M
			Heat resistive	E52-CA35AY D=1 NETU 1M	E52-CA35AY D=1 NETU 2M	E52-CA35AY D=1 NETU 4M	E52-CA35AY D=1 NETU 8M
	1.6 dia.	15	Standard	E52-CA15AY D=1.6 1M	E52-CA15AY D=1.6 2M	E52-CA15AY D=1.6 4M	E52-CA15AY D=1.6 8M
			Heat resistive	E52-CA15AY D=1.6 NETU 1M	E52-CA15AY D=1.6 NETU 2M	E52-CA15AY D=1.6 NETU 4M	E52-CA15AY D=1.6 NETU 8M
		20	Standard	E52-CA20AY D=1.6 1M	E52-CA20AY D=1.6 2M	E52-CA20AY D=1.6 4M	E52-CA20AY D=1.6 8M
			Heat resistive	E52-CA20AY D=1.6 NETU 1M	E52-CA20AY D=1.6 NETU 2M	E52-CA20AY D=1.6 NETU 4M	E52-CA20AY D=1.6 NETU 8M
		35	Standard	E52-CA35AY D=1.6 1M	E52-CA35AY D=1.6 2M	E52-CA35AY D=1.6 4M	E52-CA35AY D=1.6 8M
			Heat resistive	E52-CA35AY D=1.6 NETU 1M	E52-CA35AY D=1.6 NETU 2M	E52-CA35AY D=1.6 NETU 4M	E52-CA35AY D=1.6 NETU 8M

Terminal type	Protective tubing diameter D (mm)	Protective tubing length L (cm)	Lead wire type	Lead wire length M (m)				
				1	2	4	8	
				Model				
Exposed-lead Models	3.2 dia.	15	Standard	E52-CA15AY D=3.2 1M	E52-CA15AY D=3.2 2M	E52-CA15AY D=3.2 4M	E52-CA15AY D=3.2 8M	
			Heat resistive	E52-CA15AY D=3.2 NETU 1M	E52-CA15AY D=3.2 NETU 2M	E52-CA15AY D=3.2 NETU 4M	E52-CA15AY D=3.2 NETU 8M	
		20	Standard	E52-CA20AY D=3.2 1M	E52-CA20AY D=3.2 2M	E52-CA20AY D=3.2 4M	E52-CA20AY D=3.2 8M	
			Heat resistive	E52-CA20AY D=3.2 NETU 1M	E52-CA20AY D=3.2 NETU 2M	E52-CA20AY D=3.2 NETU 4M	E52-CA20AY D=3.2 NETU 8M	
		35	Standard	E52-CA35AY D=3.2 1M	E52-CA35AY D=3.2 2M	E52-CA35AY D=3.2 4M	E52-CA35AY D=3.2 8M	
			Heat resistive	E52-CA35AY D=3.2 NETU 1M	E52-CA35AY D=3.2 NETU 2M	E52-CA35AY D=3.2 NETU 4M	E52-CA35AY D=3.2 NETU 8M	
		50	Standard	E52-CA50AY D=3.2 1M	E52-CA50AY D=3.2 2M	E52-CA50AY D=3.2 4M	E52-CA50AY D=3.2 8M	
			Heat resistive	E52-CA50AY D=3.2 NETU 1M	E52-CA50AY D=3.2 NETU 2M	E52-CA50AY D=3.2 NETU 4M	E52-CA50AY D=3.2 NETU 8M	
		4.8 dia.	20	Standard	E52-CA20AY D=4.8 1M	E52-CA20AY D=4.8 2M	E52-CA20AY D=4.8 4M	E52-CA20AY D=4.8 8M
				Heat resistive	E52-CA20AY D=4.8 NETU 1M	E52-CA20AY D=4.8 NETU 2M	E52-CA20AY D=4.8 NETU 4M	E52-CA20AY D=4.8 NETU 8M
			35	Standard	E52-CA35AY D=4.8 1M	E52-CA35AY D=4.8 2M	E52-CA35AY D=4.8 4M	E52-CA35AY D=4.8 8M
				Heat resistive	E52-CA35AY D=4.8 NETU 1M	E52-CA35AY D=4.8 NETU 2M	E52-CA35AY D=4.8 NETU 4M	E52-CA35AY D=4.8 NETU 8M
	50		Standard	E52-CA50AY D=4.8 1M	E52-CA50AY D=4.8 2M	E52-CA50AY D=4.8 4M	E52-CA50AY D=4.8 8M	
			Heat resistive	E52-CA50AY D=4.8 NETU 1M	E52-CA50AY D=4.8 NETU 2M	E52-CA50AY D=4.8 NETU 4M	E52-CA50AY D=4.8 NETU 8M	
	6.4 dia.	20	Standard	E52-CA20AY D=6.4 1M	E52-CA20AY D=6.4 2M	E52-CA20AY D=6.4 4M	E52-CA20AY D=6.4 8M	
			Heat resistive	E52-CA20AY D=6.4 NETU 1M	E52-CA20AY D=6.4 NETU 2M	E52-CA20AY D=6.4 NETU 4M	E52-CA20AY D=6.4 NETU 8M	
		35	Standard	E52-CA35AY D=6.4 1M	E52-CA35AY D=6.4 2M	E52-CA35AY D=6.4 4M	E52-CA35AY D=6.4 8M	
			Heat resistive	E52-CA35AY D=6.4 NETU 1M	E52-CA35AY D=6.4 NETU 2M	E52-CA35AY D=6.4 NETU 4M	E52-CA35AY D=6.4 NETU 8M	
		50	Standard	E52-CA50AY D=6.4 1M	E52-CA50AY D=6.4 2M	E52-CA50AY D=6.4 4M	E52-CA50AY D=6.4 8M	
			Heat resistive	E52-CA50AY D=6.4 NETU 1M	E52-CA50AY D=6.4 NETU 2M	E52-CA50AY D=6.4 NETU 4M	E52-CA50AY D=6.4 NETU 8M	
	8 dia.	20	Standard	E52-CA20AY D=8 1M	E52-CA20AY D=8 2M	E52-CA20AY D=8 4M	E52-CA20AY D=8 8M	
			Heat resistive	E52-CA20AY D=8 NETU 1M	E52-CA20AY D=8 NETU 2M	E52-CA20AY D=8 NETU 4M	E52-CA20AY D=8 NETU 8M	
		35	Standard	E52-CA35AY D=8 1M	E52-CA35AY D=8 2M	E52-CA35AY D=8 4M	E52-CA35AY D=8 8M	
			Heat resistive	E52-CA35AY D=8 NETU 1M	E52-CA35AY D=8 NETU 2M	E52-CA35AY D=8 NETU 4M	E52-CA35AY D=8 NETU 8M	
50		Standard	E52-CA50AY D=8 1M	E52-CA50AY D=8 2M	E52-CA50AY D=8 4M	E52-CA50AY D=8 8M		
		Heat resistive	E52-CA50AY D=8 NETU 1M	E52-CA50AY D=8 NETU 2M	E52-CA50AY D=8 NETU 4M	E52-CA50AY D=8 NETU 8M		

Exposed-lead Models

E52-IC□AY

Dimensions

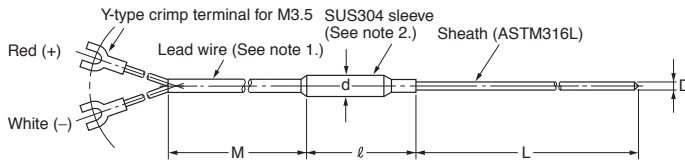

Note: 1. Lead Wire (Compensating Conductor)

- Standard (–20 C to 70 C): Fully vinyl-covered with seven 0.3-dia. conductors (0.5 mm thick) and external dimensions of 2.4 × 4.1.
 - Heat Resistant (0 C to 150 C): Fully glass-wool-covered with seven 0.3-dia. conductors (0.5 mm thick) with external shield of stainless steel and external dimensions of 2.8 × 4.6. The heat-resistant lead wires cannot be used in locations exposed to water or other liquids.
 - Lead Wire Length (M): 1, 2, 4, or 8 m
2. The sleeve resists temperatures ranging between –20 C and 70 C for standard models and 0 C and 100 C for heat-resistant models.

Unit (mm)

D	d	ℓ
1 dia.	8	55
1.6 dia.	8	55
3.2 dia.	8	55
4.8 dia.	8	55
6.4 dia.	11	55
8 dia.	11	55

Permissible Temperature in Dry Air

D	Element wire
	J (IC) ASTM316L
1 dia.	450 C
1.6 dia.	450 C
3.2 dia.	650 C
4.8 dia.	750 C
6.4 dia.	750 C
8.0 dia.	750 C

J (IC) Model Information (E52-IC□AY)

Model Information

Custom-made models are available on request. Refer to *Model Number Legend* on page 8 for details

Terminal type	Protective tubing diameter D (mm)	Protective tubing length L (cm)	Lead wire type	Lead wire length M (m)			
				1	2	4	8
				Model			
Exposed-lead Models	1 dia.	15	Standard	E52-IC15AY D=1 1M	E52-IC15AY D=1 2M	E52-IC15AY D=1 4M	E52-IC15AY D=1 8M
			Heat resistive	E52-IC15AY D=1 NETU 1M	E52-IC15AY D=1 NETU 2M	E52-IC15AY D=1 NETU 4M	E52-IC15AY D=1 NETU 8M
		20	Standard	E52-IC20AY D=1 1M	E52-IC20AY D=1 2M	E52-IC20AY D=1 4M	E52-IC20AY D=1 8M
			Heat resistive	E52-IC20AY D=1 NETU 1M	E52-IC20AY D=1 NETU 2M	E52-IC20AY D=1 NETU 4M	E52-IC20AY D=1 NETU 8M
		35	Standard	E52-IC35AY D=1 1M	E52-IC35AY D=1 2M	E52-IC35AY D=1 4M	E52-IC35AY D=1 8M
			Heat resistive	E52-IC35AY D=1 NETU 1M	E52-IC35AY D=1 NETU 2M	E52-IC35AY D=1 NETU 4M	E52-IC35AY D=1 NETU 8M
	1.6 dia.	15	Standard	E52-IC15AY D=1.6 1M	E52-IC15AY D=1.6 2M	E52-IC15AY D=1.6 4M	E52-IC15AY D=1.6 8M
			Heat resistive	E52-IC15AY D=1.6 NETU 1M	E52-IC15AY D=1.6 NETU 2M	E52-IC15AY D=1.6 NETU 4M	E52-IC15AY D=1.6 NETU 8M
		20	Standard	E52-IC20AY D=1.6 1M	E52-IC20AY D=1.6 2M	E52-IC20AY D=1.6 4M	E52-IC20AY D=1.6 8M
			Heat resistive	E52-IC20AY D=1.6 NETU 1M	E52-IC20AY D=1.6 NETU 2M	E52-IC20AY D=1.6 NETU 4M	E52-IC20AY D=1.6 NETU 8M
		35	Standard	E52-IC35AY D=1.6 1M	E52-IC35AY D=1.6 2M	E52-IC35AY D=1.6 4M	E52-IC35AY D=1.6 8M
			Heat resistive	E52-IC35AY D=1.6 NETU 1M	E52-IC35AY D=1.6 NETU 2M	E52-IC35AY D=1.6 NETU 4M	E52-IC35AY D=1.6 NETU 8M

Terminal type	Protective tubing diameter D (mm)	Protective tubing length L (cm)	Lead wire type	Lead wire length M (m)				
				1	2	4	8	
				Model				
Exposed-lead Models	3.2 dia.	15	Standard	E52-IC15AY D=3.2 1M	E52-IC15AY D=3.2 2M	E52-IC15AY D=3.2 4M	E52-IC15AY D=3.2 8M	
			Heat resistive	E52-IC15AY D=3.2 NETU 1M	E52-IC15AY D=3.2 NETU 2M	E52-IC15AY D=3.2 NETU 4M	E52-IC15AY D=3.2 NETU 8M	
		20	Standard	E52-IC20AY D=3.2 1M	E52-IC20AY D=3.2 2M	E52-IC20AY D=3.2 4M	E52-IC20AY D=3.2 8M	
			Heat resistive	E52-IC20AY D=3.2 NETU 1M	E52-IC20AY D=3.2 NETU 2M	E52-IC20AY D=3.2 NETU 4M	E52-IC20AY D=3.2 NETU 8M	
		35	Standard	E52-IC35AY D=3.2 1M	E52-IC35AY D=3.2 2M	E52-IC35AY D=3.2 4M	E52-IC35AY D=3.2 8M	
			Heat resistive	E52-IC35AY D=3.2 NETU 1M	E52-IC35AY D=3.2 NETU 2M	E52-IC35AY D=3.2 NETU 4M	E52-IC35AY D=3.2 NETU 8M	
		50	Standard	E52-IC50AY D=3.2 1M	E52-IC50AY D=3.2 2M	E52-IC50AY D=3.2 4M	E52-IC50AY D=3.2 8M	
			Heat resistive	E52-IC50AY D=3.2 NETU 1M	E52-IC50AY D=3.2 NETU 2M	E52-IC50AY D=3.2 NETU 4M	E52-IC50AY D=3.2 NETU 8M	
		4.8 dia.	20	Standard	E52-IC20AY D=4.8 1M	E52-IC20AY D=4.8 2M	E52-IC20AY D=4.8 4M	E52-IC20AY D=4.8 8M
				Heat resistive	E52-IC20AY D=4.8 NETU 1M	E52-IC20AY D=4.8 NETU 2M	E52-IC20AY D=4.8 NETU 4M	E52-IC20AY D=4.8 NETU 8M
			35	Standard	E52-IC35AY D=4.8 1M	E52-IC35AY D=4.8 2M	E52-IC35AY D=4.8 4M	E52-IC35AY D=4.8 8M
				Heat resistive	E52-IC35AY D=4.8 NETU 1M	E52-IC35AY D=4.8 NETU 2M	E52-IC35AY D=4.8 NETU 4M	E52-IC35AY D=4.8 NETU 8M
	50		Standard	E52-IC50AY D=4.8 1M	E52-IC50AY D=4.8 2M	E52-IC50AY D=4.8 4M	E52-IC50AY D=4.8 8M	
			Heat resistive	E52-IC50AY D=4.8 NETU 1M	E52-IC50AY D=4.8 NETU 2M	E52-IC50AY D=4.8 NETU 4M	E52-IC50AY D=4.8 NETU 8M	
	6.4 dia.	20	Standard	E52-IC20AY D=6.4 1M	E52-IC20AY D=6.4 2M	E52-IC20AY D=6.4 4M	E52-IC20AY D=6.4 8M	
			Heat resistive	E52-IC20AY D=6.4 NETU 1M	E52-IC20AY D=6.4 NETU 2M	E52-IC20AY D=6.4 NETU 4M	E52-IC20AY D=6.4 NETU 8M	
		35	Standard	E52-IC35AY D=6.4 1M	E52-IC35AY D=6.4 2M	E52-IC35AY D=6.4 4M	E52-IC35AY D=6.4 8M	
			Heat resistive	E52-IC35AY D=6.4 NETU 1M	E52-IC35AY D=6.4 NETU 2M	E52-IC35AY D=6.4 NETU 4M	E52-IC35AY D=6.4 NETU 8M	
		50	Standard	E52-IC50AY D=6.4 1M	E52-IC50AY D=6.4 2M	E52-IC50AY D=6.4 4M	E52-IC50AY D=6.4 8M	
			Heat resistive	E52-IC50AY D=6.4 NETU 1M	E52-IC50AY D=6.4 NETU 2M	E52-IC50AY D=6.4 NETU 4M	E52-IC50AY D=6.4 NETU 8M	
	8 dia.	20	Standard	E52-IC20AY D=8 1M	E52-IC20AY D=8 2M	E52-IC20AY D=8 4M	E52-IC20AY D=8 8M	
			Heat resistive	E52-IC20AY D=8 NETU 1M	E52-IC20AY D=8 NETU 2M	E52-IC20AY D=8 NETU 4M	E52-IC20AY D=8 NETU 8M	
		35	Standard	E52-IC35AY D=8 1M	E52-IC35AY D=8 2M	E52-IC35AY D=8 4M	E52-IC35AY D=8 8M	
			Heat resistive	E52-IC35AY D=8 NETU 1M	E52-IC35AY D=8 NETU 2M	E52-IC35AY D=8 NETU 4M	E52-IC35AY D=8 NETU 8M	
50		Standard	E52-IC50AY D=8 1M	E52-IC50AY D=8 2M	E52-IC50AY D=8 4M	E52-IC50AY D=8 8M		
		Heat resistive	E52-IC50AY D=8 NETU 1M	E52-IC50AY D=8 NETU 2M	E52-IC50AY D=8 NETU 4M	E52-IC50AY D=8 NETU 8M		

Exposed-terminal Models

E52-CA□B-N E52-IC□B-N

Dimensions

Dimensions are given in millimeters, except for the length (L), which is provided in centimeters.

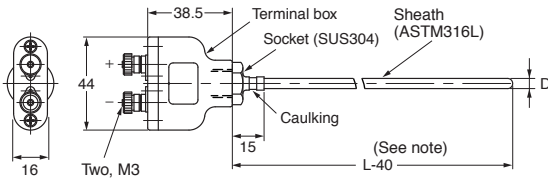

Note: The length L is in centimeters, but “40” is 40 millimeters.
Therefore, for the E52-CA50B-N: L = 50 (cm), the sheath length L – 40 = 500 – 40 = 460 mm.

Model Information

Custom-made models are available on request. Refer to *Model Number Legend* on page 8 for details.

Element type	Terminal type	Protective tubing length L (cm)	Protective tubing diameter D (mm)			
			3.2 dia.	4.8 dia.	6.4 dia.	8 dia.
Model						
K (CA)	Exposed-terminal Models	20	E52-CA20B-N D=3.2	E52-CA20B-N D=4.8	E52-CA20B-N D=6.4	---
		35	E52-CA35B-N D=3.2	E52-CA35B-N D=4.8	E52-CA35B-N D=6.4	E52-CA35B-N D=8
		50	E52-CA50B-N D=3.2	E52-CA50B-N D=4.8	E52-CA50B-N D=6.4	E52-CA50B-N D=8
		75	---	E52-CA75B-N D=4.8	E52-CA75B-N D=6.4	E52-CA75B-N D=8
J (IC)	Exposed-terminal Models	20	E52-IC20B-N D=3.2	E52-IC20B-N D=4.8	E52-IC20B-N D=6.4	---
		35	E52-IC35B-N D=3.2	E52-IC35B-N D=4.8	E52-IC35B-N D=6.4	E52-IC35B-N D=8
		50	E52-IC50B-N D=3.2	E52-IC50B-N D=4.8	E52-IC50B-N D=6.4	E52-IC50B-N D=8
		75	---	E52-IC75B-N D=4.8	E52-IC75B-N D=6.4	E52-IC75B-N D=8

Permissible Temperature in Dry Air

D	Element wire	
	K (CA) ASTM316L	J (IC) ASTM316L
3.2 dia.	750 C	650 C
4.8 dia.	800 C	750 C
6.4 dia.	800 C	750 C
8.0 dia.	900 C	750 C

Terminal box: The permissible temperature is 0 C to 100 C.

Enclosed-terminal Models

E52-CA□C-N E52-IC□C-N

Dimensions

Dimensions are given in millimeters, except for the length (L), which is provided in centimeters.

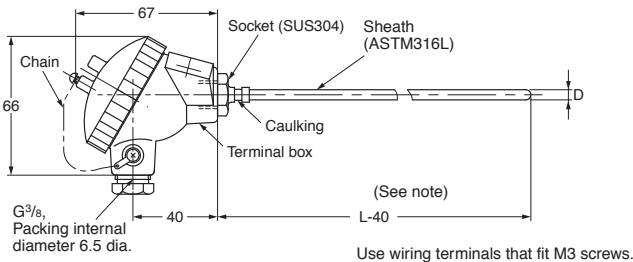

Note: The length L is in centimeters, but “40” is 40 millimeters.
Therefore, for the E52-CA35C-N: L = 35 (cm), the sheath length L – 40 = 350 – 40 = 310 mm.

Model Information

Custom-made models are available on request. Refer to *Model Number Legend* on page 8 for details.

Element type	Terminal type	Protective tubing length L (cm)	Protective tubing diameter D (mm)			
			3.2 dia.	4.8 dia.	6.4 dia.	8 dia.
Model						
K (CA)	Enclosed-terminal Models	20	E52-CA20C-N D=3.2	E52-CA20C-N D=4.8	E52-CA20C-N D=6.4	---
		35	E52-CA35C-N D=3.2	E52-CA35C-N D=4.8	E52-CA35C-N D=6.4	E52-CA35C-N D=8
		50	E52-CA50C-N D=3.2	E52-CA50C-N D=4.8	E52-CA50C-N D=6.4	E52-CA50C-N D=8
		75	---	E52-CA75C-N D=4.8	E52-CA75C-N D=6.4	E52-CA75C-N D=8
J (IC)	Enclosed-terminal Models	20	E52-IC20C-N D=3.2	E52-IC20C-N D=4.8	E52-IC20C-N D=6.4	---
		35	E52-IC35C-N D=3.2	E52-IC35C-N D=4.8	E52-IC35C-N D=6.4	E52-IC35C-N D=8
		50	E52-IC50C-N D=3.2	E52-IC50C-N D=4.8	E52-IC50C-N D=6.4	E52-IC50C-N D=8
		75	---	E52-IC75C-N D=4.8	E52-IC75C-N D=6.4	E52-IC75C-N D=8

Permissible Temperature in Dry Air

D	Element wire	
	K (CA) ASTM316L	J (IC) ASTM316L
3.2 dia.	750 C	650 C
4.8 dia.	800 C	750 C
6.4 dia.	800 C	750 C
8.0 dia.	900 C	750 C

Terminal box: The permissible temperature is 0 C to 90 C.

Note: The terminals in the cap indicate polarity (+ or -).

■ Standard Thermocouples

Specifications

Element wire	K (CA), J (IC), R	
Class	K (CA), J (IC) JIS class 2 (0.75)	
	R, JIS class 2 (0.25)	
Protective tubing material	K (CA)	SUS316
	J (IC)	SUS316
	R (See note.)	JIS ceramic cat. 1 (PT1)
		JIS special ceramic (PT0)
Thermal contact	Non-grounded type	

Note: Specify PT1 or PT0 if the element is R.

Permissible Temperature in Dry Air (See note.)

D	Element wire	
	K (CA) SUS316	J (IC) SUS316
10 dia.	750 C	450 C
12 dia.	850 C	500 C
15 dia.	850 C	550 C
22 dia.	900 C	600 C

Note: For details on the permissible temperature, refer to *Technical Guide for Temperature Sensors*.

D	Element wire
	R
15 dia.	0 C to 1,400 C

Exposed-terminal Models

E52-CA□B-N

E52-IC□B-N

Dimensions

Dimensions are given in millimeters, except for the length (L), which is provided in centimeters.

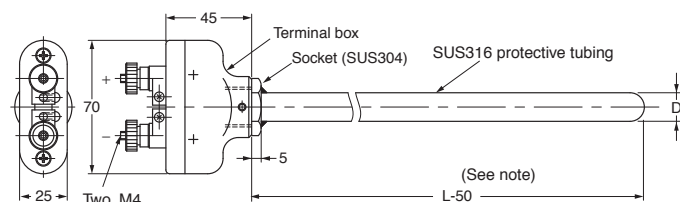

Terminal box: The permissible temperature is 0 C to 100 C.

Note: The length L is in centimeters, but "50" is 50 millimeters.

Therefore, for the E52-CA75B-N: $L = 75$ (cm), the protective tubing length $L - 50 = 75 - 50 = 25$ mm.

Permissible Temperature in Dry Air

D	Element wire	
	K (CA) SUS316	J (IC) SUS316
10 dia.	750 C	450 C
12 dia.	850 C	500 C
15 dia.	850 C	550 C
22 dia.	900 C	600 C

Model Information

Custom-made models are available on request. Refer to *Model Number Legend* on page 8 for details.

Element type	Terminal type	Protective tubing length L (cm)	Protective tubing diameter D (mm)			
			10 dia.	12 dia.	15 dia.	22 dia.
Model						
K (CA)	Exposed-terminal Models	35	E52-CA35B-N D=10	E52-CA35B-N D=12	E52-CA35B-N D=15	---
		50	E52-CA50B-N D=10	E52-CA50B-N D=12	E52-CA50B-N D=15	E52-CA50B-N D=22
		75	E52-CA75B-N D=10	E52-CA75B-N D=12	E52-CA75B-N D=15	E52-CA75B-N D=22
		100	E52-CA100B-N D=10	E52-CA100B-N D=12	E52-CA100B-N D=15	E52-CA100B-N D=22
J (IC)	Exposed-terminal Models	35	E52-IC35B-N D=10	E52-IC35B-N D=12	E52-IC35B-N D=15	---
		50	E52-IC50B-N D=10	E52-IC50B-N D=12	E52-IC50B-N D=15	E52-IC50B-N D=22
		75	E52-IC75B-N D=10	E52-IC75B-N D=12	E52-IC75B-N D=15	E52-IC75B-N D=22
		100	E52-IC100B-N D=10	E52-IC100B-N D=12	E52-IC100B-N D=15	E52-IC100B-N D=22

Enclosed-terminal Models

E52-CA□C-N

E52-IC□C-N

Dimensions

Dimensions are given in millimeters, except for the length (L), which is provided in centimeters.

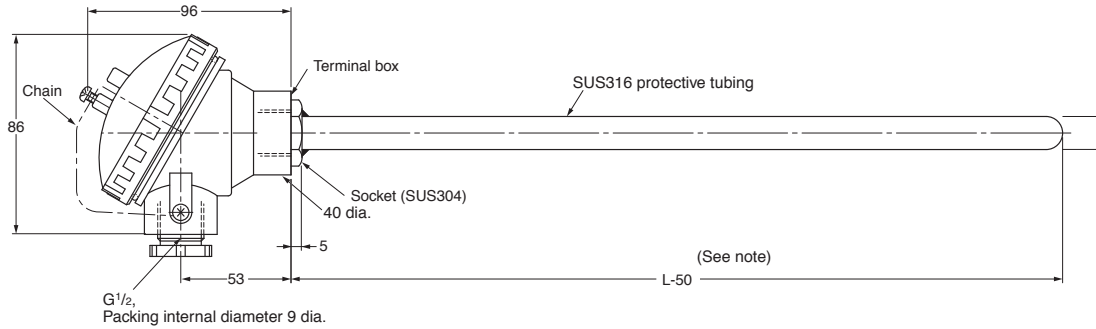

Note: The length L is in centimeters, but “50” is 50 millimeters.
Therefore, for the E52-CA50C-N: L = 50 (cm), the protective tubing length $L - 50 = 500 - 50 = 450$ mm.

Permissible Temperature in Dry Air

D	Element wire	
	K (CA) SUS316	J (IC) SUS316
10 dia.	0 to 750 C	0 to 450 C
12 dia.	0 to 850 C	0 to 500 C
15 dia.	0 to 850 C	0 to 550 C
22 dia.	0 to 900 C	0 to 600 C

Terminal box: The permissible temperature is 0 C to 90 C.

Note: The terminals in the cap indicate polarity (+ or -).

Model Information

Custom-made models are available on request. Refer to *Model Number Legend* on page 8 for details

Element type	Terminal type	Protective tubing length L (cm)	Protective tubing diameter D (mm)			
			10 dia.	12 dia.	15 dia.	22 dia.
Model						
K (CA)	Enclosed-terminal Models	35	E52-CA35C-N D=10	E52-CA35C-N D=12	E52-CA35C-N D=15	---
		50	E52-CA50C-N D=10	E52-CA50C-N D=12	E52-CA50C-N D=15	E52-CA50C-N D=22
		75	E52-CA75C-N D=10	E52-CA75C-N D=12	E52-CA75C-N D=15	E52-CA75C-N D=22
		100	E52-CA100C-N D=10	E52-CA100C-N D=12	E52-CA100C-N D=15	E52-CA100C-N D=22
J (IC)	Enclosed-terminal Models	35	E52-IC35C-N D=10	E52-IC35C-N D=12	E52-IC35C-N D=15	---
		50	E52-IC50C-N D=10	E52-IC50C-N D=12	E52-IC50C-N D=15	E52-IC50C-N D=22
		75	E52-IC75C-N D=10	E52-IC75C-N D=12	E52-IC75C-N D=15	---
		100	E52-IC100C-N D=10	E52-IC100C-N D=12	E52-IC100C-N D=15	---

Enclosed-terminal Models (High-temperature Use)

E52-PR□C-N

Dimensions

Dimensions are given in millimeters, except for the length (L), which is provided in centimeters.

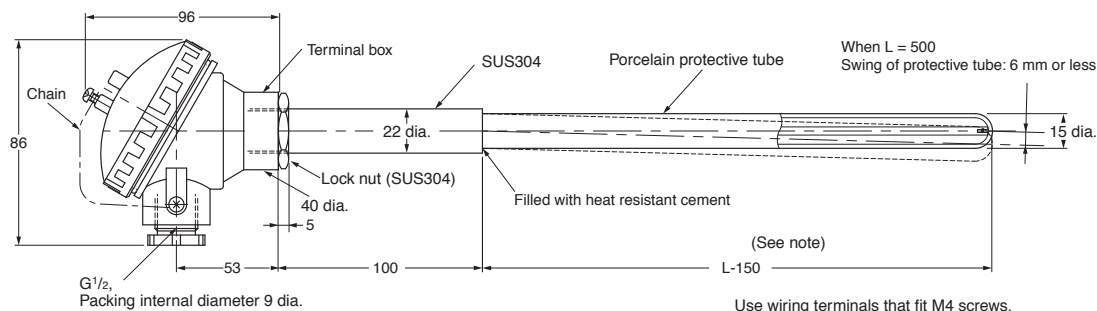

Permissible Temperature in Dry Air

D	Element wire
	R
15 dia.	0 C to 1,400 C

Terminal box: The permissible temperature is 0 C to 90 C.

Note: The terminals in the cap indicate polarity (+ or -).

Note: The length L is in centimeters, but "150" is 150 millimeters. Therefore, for the E52-PR75C-N: L = 75 (cm), the protective tubing length $L - 150 = 75 - 150 = 600$ mm.

Model Information

Element type	Terminal type	Protective tubing length L (cm)	Protective tubing diameter D (mm)
			Model
R (See note 1.)	Enclosed-terminal Models	50	E52-PR50C-N D=15 PT1
		75	E52-PR75C-N D=15 PT1
		100	E52-PR100C-N D=15 PT1
R (See note 2.)	Enclosed-terminal Models	50	E52-PR50C-N D=15 PT0
		75	E52-PR75C-N D=15 PT0
		100	E52-PR100C-N D=15 PT0

Standard	Protective tubing material	Permissible temperature in dry air
Note 1: JIS ceramic Cat.1 (PT1)	Mullite, high alumina, etc.	1,500 C (See note.)
Note 2: JIS special ceramic (PT0)	Recrystallized alumina, fused alumina, etc.	1,700 C (See note.)

Note: The permissible temperature given for the protective tubing is higher than 1,400 C, but the permissible temperature of the thermocouple element wire is only 1,400 C. Therefore, the protective tubing of the E52-PR□C-N can withstand high temperatures momentarily to the levels given in the table as exceptions, but the element wire will deteriorate quickly if the thermocouple is used regularly at temperatures that exceed the permissible temperature for the element wire.

Low-cost Models

Low-cost Platinum Resistance Thermometers

Exposed-lead Models with Screws

Specifications

Element type	Pt100
Conductor type	3-conductor system
Class	Class B
Protective tubing material	SUS304
Sensor length	30 mm
Max. detectable temperature	250 C
Temperature range	-50 C to 250 C
Lead wire	-50 C to 150 C

E52-P6DY

Dimensions

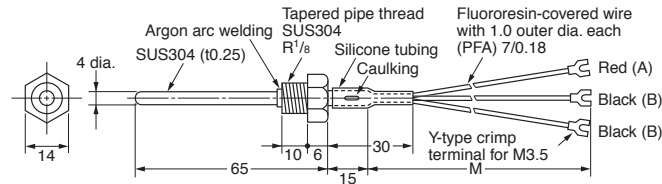

Note: The protective tubing is of pipe construction, which must not be bent.

Lead wire length (m)	Model
1	E52-P6DY 1M
2	E52-P6DY 2M
4	E52-P6DY 4M

Exposed-lead Models with Flange

Specifications

Element wire	Pt100
Conductor type	3-conductor system
Class	Class B
Protective tubing material	SUS304
Sensor length	30 mm
Max. detectable temperature	250 C
Temperature range	-50 C to 250 C
Lead wire	-50 C to 150 C

E52-P6FY

Dimensions

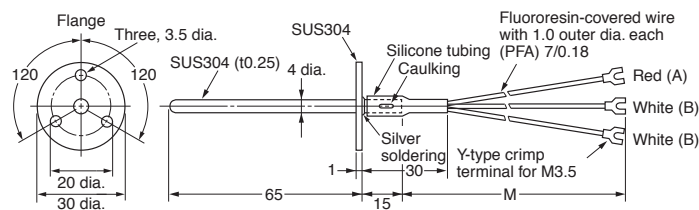

Note: The protective tubing is of pipe construction, which must not be bent.

Lead wire length (m)	Model
1	E52-P6FY 1M
2	E52-P6FY 2M
4	E52-P6FY 4M

Exposed-lead Models

Specifications

Element type	Pt100
Conductor type	3-conductor system
Class	Class B
Protective tubing material	SUS304
Max. detectable temperature	250 C
Temperature range	0 C to 250 C
Lead wire	-50 C to 180 C

E52-P10AEY

Dimensions

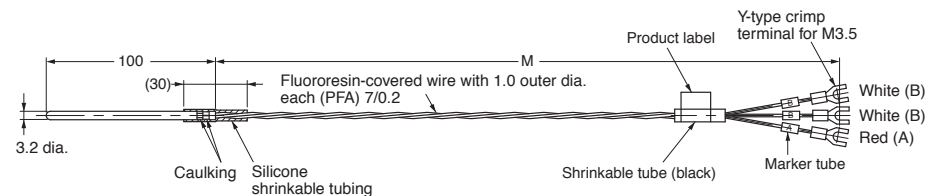

Note: 1. The protective tubing is of pipe construction, which must not be bent.
2. A Compression Fitting (PT□) cannot be used for mounting.

Lead wire length (m)	Model
1	E52-P10AEY 1M
2	E52-P10AEY 2M
4	E52-P10AEY 4M

■ Low-cost Thermocouples

Exposed-lead Models with Spring

Specifications

Element type	K (CA), J (IC)
Element dia.	0.65 mm (single wire)
Class	Class 2 (0.75)
Protective tubing material	SUS304
Thermal contact	Non-grounded type
Temperature range	0 C to 400 C: K (CA) 0 C to 350 C: J (IC)
Lead wire	0 C to 180 C

E52-CA□ASY, E52-IC□ASY

Dimensions

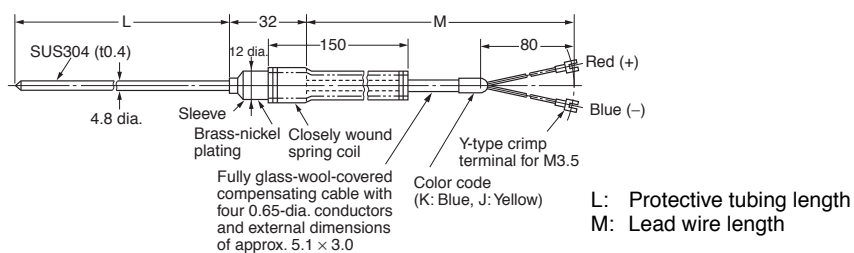

Note: The sleeve resists temperatures ranging between 0 C and 100 C.

Note: The protective tubing is of pipe construction, which must not be bent.

Protective tubing length (mm)	Lead wire length (m)	Element type: K (CA)	Element type: J (IC)
		Model	
65	1	E52-CA6ASY 1M	E52-IC6ASY 1M
	2	E52-CA6ASY 2M	E52-IC6ASY 2M
	4	E52-CA6ASY 4M	E52-IC6ASY 4M
100	1	E52-CA10ASY 1M	E52-IC10ASY 1M
	2	E52-CA10ASY 2M	E52-IC10ASY 2M
	4	E52-CA10ASY 4M	E52-IC10ASY 4M
150	1	E52-CA15ASY 1M	E52-IC15ASY 1M
	2	E52-CA15ASY 2M	E52-IC15ASY 2M
	4	E52-CA15ASY 4M	E52-IC15ASY 4M
200	1	E52-CA20ASY 1M	E52-IC20ASY 1M
	2	E52-CA20ASY 2M	E52-IC20ASY 2M
	4	E52-CA20ASY 4M	E52-IC20ASY 4M

Exposed-lead Models with Screw

Specifications

Element type	K (CA), J (IC)
Element dia.	0.65 mm (single wire)
Class	Class 2 (0.75)
Protective tubing material	SUS304
Thermal contact	Grounded type
Temperature range	0 C to 400 C: K (CA) 0 C to 350 C: J (IC)
Lead wire	0 C to 180 C
Terminal shape	Y-type crimp terminal for M3.5

E52-CA1DY, E52-IC1DY

Dimensions

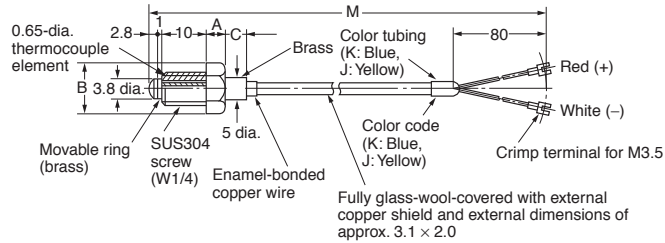

- Note:**
1. The thermocouple is a single wire from the tip to the terminal.
 2. Specify the type of screw (i.e., M6, M8, or W1/4) when ordering.
 3. The thermocouple is not of airtight construction.
 4. OMRON recommends that the tip of the thermocouple is touching the sensing object.

Internal Construction (E52-CA1DY)

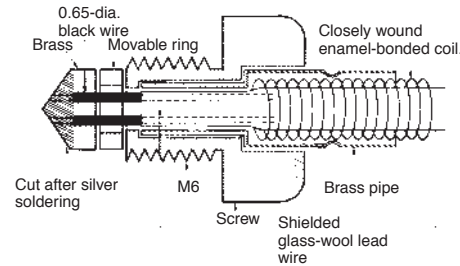

Lead wire length (m)	Screw		
	W1/4	M6	M8
A (mm)	5	4	5.3
B (mm)	11.5	11	14
C (mm)	3	4	2.5

Installation Example

Cut a thread into the workpiece, and screw in the thermocouple while pushing in so that the tip makes complete contact.

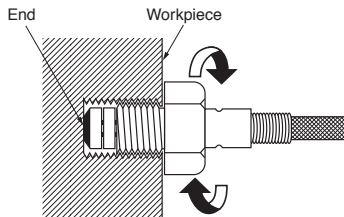

Note: E52-CA1DY with the same shape and multiple element wires are also available (E52-CA1DY-40). Refer to page 26 for details.

Protective tubing length (mm)	Lead wire length (m)	Element type: K (CA)	Element type: J (IC)
		Model	
M6 screw	1	E52-CA1DY M6 1M	E52-IC1DY M6 1M
	2	E52-CA1DY M6 2M	E52-IC1DY M6 2M
	4	E52-CA1DY M6 4M	E52-IC1DY M6 4M
M8 screw	1	E52-CA1DY M8 1M	E52-IC1DY M8 1M
	2	E52-CA1DY M8 2M	E52-IC1DY M8 2M
	4	E52-CA1DY M8 4M	E52-IC1DY M8 4M
W1/4 screw	1	E52-CA1DY W1/4 1M	E52-IC1DY W1/4 1M
	2	E52-CA1DY W1/4 2M	E52-IC1DY W1/4 2M
	4	E52-CA1DY W1/4 4M	E52-IC1DY W1/4 4M

Exposed-lead Models with Flange

Specifications

Element type	K (CA), J (IC)
Class	Class 2 (0.75)
Protective tubing material	SUS304
Thermal contact	Grounded type
Temperature range	0 C to 350 C: K (CA) 0 C to 350 C: J (IC)
Lead wire	0 C to 150 C

E52-CA6F-N, E52-IC6F-N

Dimensions

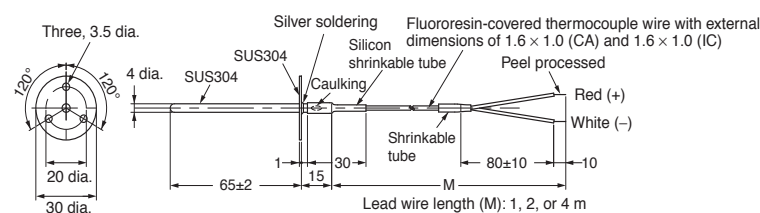

- Note:** 1. The thermocouple is a single wire from the tip to the terminal.
2. The protective tubing is of pipe construction, which must not be bent.

Lead wire length (m)	Element type: K (CA)	Element type: J (IC)
	Model	
1	E52-CA6F-N 1M	E52-IC6F-N 1M
2	E52-CA6F-N 2M	E52-IC6F-N 2M
4	E52-CA6F-N 4M	E52-IC6F-N 4M

Exposed-lead Models with Screws

Specifications

Element type	K (CA), J (IC)
Class	Class 2 (0.75)
Protective tubing material	SUS304
Thermal contact	Grounded type
Temperature range	0 C to 350 C: K (CA) 0 C to 350 C: J (IC)
Lead wire	0 C to 150 C

E52-CA6D-N, E52-IC6D-N

Dimensions

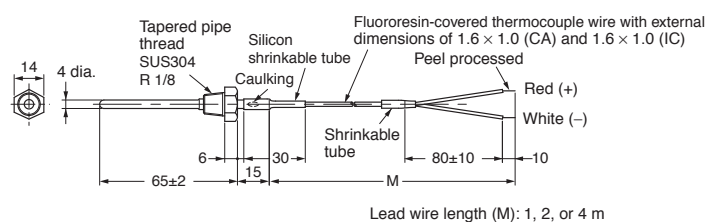

- Note:** 1. The thermocouple is a single wire from the tip to the terminal.
2. The protective tubing is of pipe construction, which must not be bent.

Lead wire length (m)	Element type: K (CA)	Element type: J (IC)
	Model	
1	E52-CA6D-N 1M	E52-IC6D-N 1M
2	E52-CA6D-N 2M	E52-IC6D-N 2M
4	E52-CA6D-N 4M	E52-IC6D-N 4M

Exposed-lead Models

Specifications

Element type	K (CA), J (IC)
Class	Class 2 (0.75)
Protective tubing material	SUS304
Thermal contact	Non-grounded type
Temperature range	0 C to 350 C: K (CA) 0 C to 200 C: J (IC)
Lead wire	0 C to 180 C

E52-CA10AE-N, E52-IC10AE-N

Dimensions

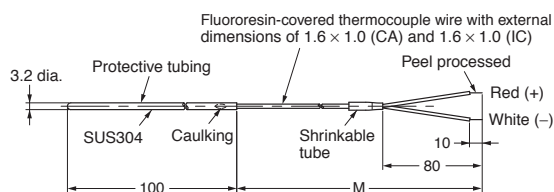

- Note:** 1. The thermocouple is a single wire from the tip to the terminal.
2. Lead wire length M: 1, 2, or 4 m
3. The protective tubing is of pipe construction, which must not be bent.
4. The thermocouple cannot be mounted using a PT Compression Fitting.

Lead wire length (m)	Element type: K (CA)	Element type: J (IC)
	Model	
1	E52-CA10AE-N 1M	E52-IC10AE-N 1M
2	E52-CA10AE-N 2M	E52-IC10AE-N 2M
4	E52-CA10AE-N 4M	E52-IC10AE-N 4M

Exclusive Models

■ Thermocouples

Thermocouples for Molding Machines

Specifications

Element type	K (CA), J (IC)
Element diameter	1.0 mm (single wire)
Class	Class 2 (0.75)
Protective tubing material	SUS304
Thermal contact	Grounded type
Temperature range	0 C to 350 C
Lead wire	0 C to 180 C

E52-CA2GVY, E52-IC2GVY

Dimensions

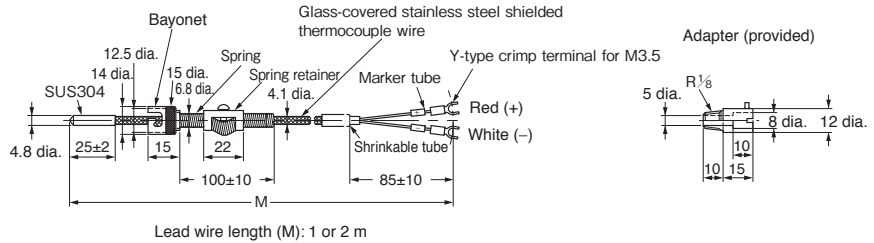

Lead wire length (M): 1 or 2 m

Lead wire length (m)	Element type: K (CA)	Element type: J (IC)
	Model	
1	E52-CA2GVY 1M	E52-IC2GVY 1M
2	E52-CA2GVY 2M	E52-IC2GVY 2M

Thermocouples with Crimp Terminals

Specifications

Element type	K (CA), J (IC)
Element diameter	0.65 mm (single wire)
Class	Class 2 (0.75)
Thermal contact	Grounded type
Temperature range	0 C to 300 C
Lead wire	0 C to 150 C
Terminal shape	Y-type crimp terminal for M3.5

E52-CA1GTY, E52-IC1GTY

Dimensions

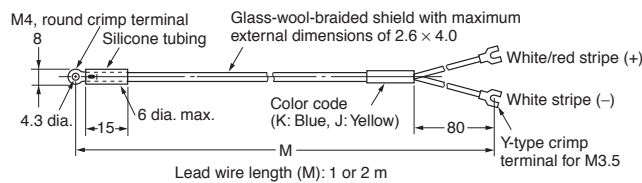

Lead wire length (M): 1 or 2 m

Lead wire length (m)	Element type: K (CA)	Element type: J (IC)
	Model	
1	E52-CA1GTY 1M	E52-IC1GTY 1M
2	E52-CA1GTY 2M	E52-IC1GTY 2M

Note: The E52-CA1GTY is also available with double elements. Refer to below for details.

■ Platinum Resistance Thermometers

Platinum Resistance Thermometers for Surface Temperature Measurement

Specifications

Element type	Pt100
Class	Class B
Protective tubing material	SUS304 With brass-nickel-plated bracket
Conductor type	3-conductor system
Temperature range	-50 C to 250 C
Lead wire	-50 C to 150 C

E52-P2GSY

Dimensions

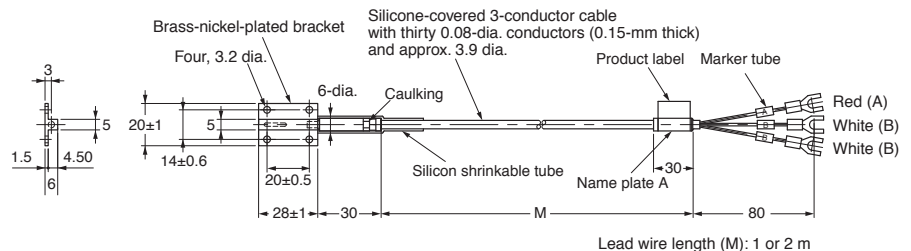

Lead wire length (M): 1 or 2 m

Lead wire length (m)	Model
1	E52-P2GSY 1M
2	E52-P2GSY 2M

Platinum Resistance Thermometers for Room Temperature Measurement

Specifications

Element type	Pt100
Class	Class B
Protective tubing material	SUS304
Conductor type	3-conductor system
Temperature range	-50 C to 60 C
Lead wire	-20 C to 60 C

E52-P10GRY

Dimensions

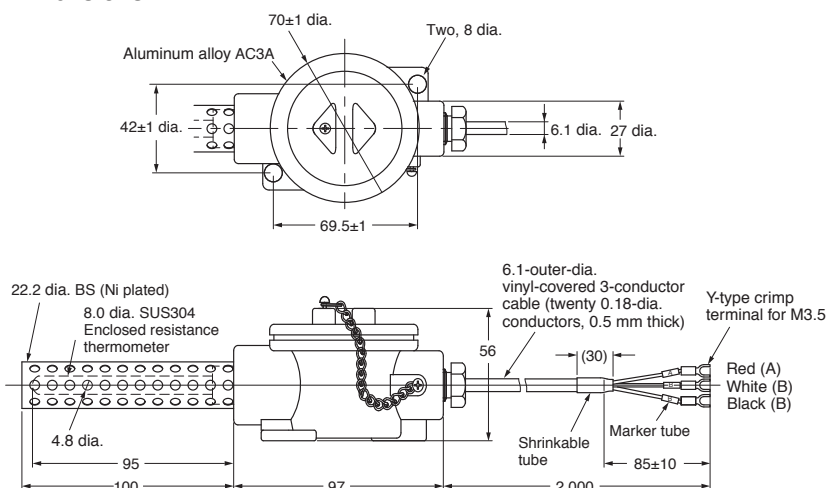

Lead wire length (m)	Model
2	E52-P10GRY 2M

Waterproof Platinum Resistance Thermometers

Specifications

Element wire	Pt100
Class	Class B
Protective tubing material	SUS304
Conductor type	3-conductor system
Temperature range	0 C to 70 C (underwater) -20 C to 70 C (in the air)
Lead wire	-25 C to 60 C
Resistive pressure	10 kg/cm ² max.

E52-P10GPY

Dimensions

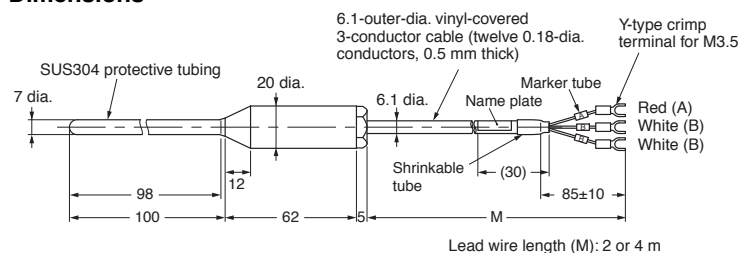

Lead wire length (M): 2 or 4 m

Note: The lead wires are vinyl-covered, and cannot be used underwater. Use the E52-P5A-N-40 if waterproof lead wires are required for use underwater. Refer to page 23 for details.

Lead wire length (m)	Model
2	E52-P10GPY 2M
4	E52-P10GPY 4M

Corrosion-resistant Models with Fluororesin-covered Protective Tubing

■ Thermocouples

Exposed-lead Models

Specifications

Element type	K (CA)
Class	Class 2 (0.75)
Protective tubing material	ASTM316L with Fluororesin-covered (FEP) tube
Thermal contact	Non-grounded type
Temperature range	0 C to 180 C
Lead wire	Vinyl-covered: -20 C to 70 C

E52-CA20AY-1

Dimensions

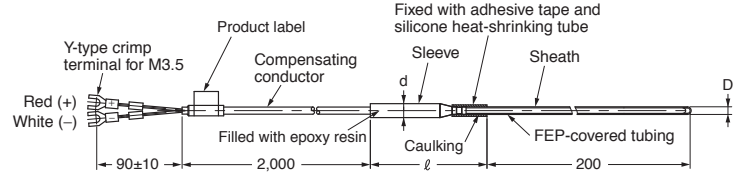

Model	Protective tubing diameter	Sleeve diameter (mm) Sleeve length (mm)	Covering thickness (mm)	Lead wire length (m)
E52-CA20AY-1 D=4.6 2M	D = 4.6	d = 8	0.7	2
E52-CA20AY-1 D=6 2M	D = 6.0	l = 55	0.6	
E52-CA20AY-1 D=8 2M	D = 8.0	d = 11 l = 55	0.8	

■ Platinum Measurement

Exposed-lead Models

Specifications

Element type	Pt100
Class	Class B
Protective tubing material	SUS316 with Fluororesin-covered (FEP) tube
Conductor type	3-conductor system
Temperature range	-80 C to 180 C
Lead wire	Vinyl-covered: -20 C to 70 C

E52-P20AY-1

Dimensions

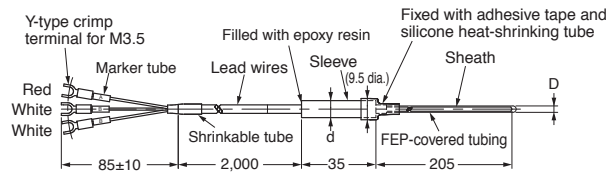

Model	Protective tubing diameter	Sleeve diameter (mm)	Coating thickness (mm)	Lead wire length (m)
E52-P20AY-1 D=4.6 2M	D = 4.6	d = 8	0.7	2
E52-P20AY-1 D=6 2M	D = 6.0	d = 8	0.6	
E52-P20AY-1 D=8 2M	D = 8.0	d = 8	0.8	

FEP-molded Models (Completely Waterproof)

Specifications

Element type	Pt100
Class	Class B
Protective tubing material	Fluororesin (FEP) tube (element / fluororesin mold (FEP))
Conductor type	3-conductor system
Temperature range	-50 C to 180 C
Lead wire	Fluororesin (FEP) cover (with outer cover): -50 C to 180 C

E52-P5AY-40

Dimensions

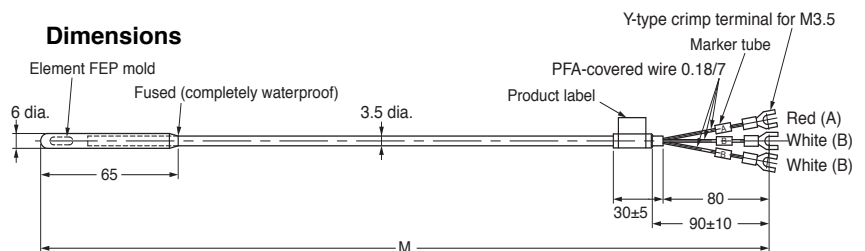

Model	Lead wire length (m)
E52-P5AY-40 2M	2
E52-P5AY-40 4M	4
E52-P5AY-40 6M	6
E52-P5AY-40 8M	8

Pressure-resistant Explosion-proof (IICT6) Models

■ Thermocouples

Enclosed-terminal Models

E52-CA□□C-N-6

Dimensions

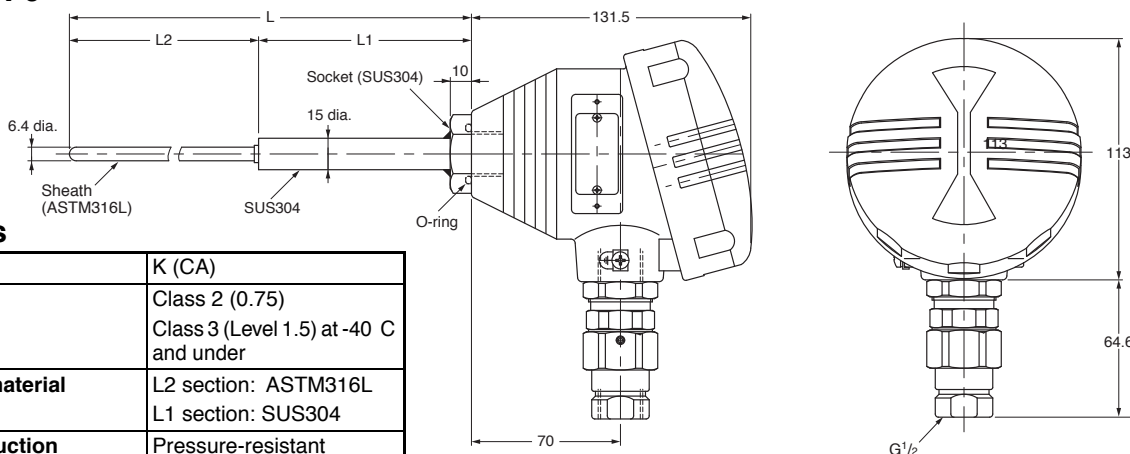

Specifications

Element type	K (CA)	
Class	Class 2 (0.75) Class 3 (Level 1.5) at -40 C and under	
Protective tubing material	L2 section: ASTM316L L1 section: SUS304	
Explosion-proof specifications	Construction	Pressure-resistant explosion-proof structure
	Explosion-protected class and ignitability	IICT6
	Explosion-proof temperature range	-20 C to 85 C
	Lead wire wiring method	Pressure-resistant packing cable ground type
	Conduit thread	G1/2
	Installation method	Conforms to Technical Recommendations of the Research Institute of Industrial Safety (Japan)

Model	Protective tubing length L (cm)	Protective tubing diameter	L2 (mm)
E52-CA20C-N-6 D=6.4 L2=150	20	D = 6.4	150
E52-CA35C-N-6 D=6.4 L2=300	35	D = 6.4	300
E52-CA50C-N-6 D=6.4 L2=450	50	D = 6.4	450
E52-CA75C-N-6 D=6.4 L2=700	75	D = 6.4	700

■ Platinum Resistance Thermometers for Surface Temperature Measurement

Enclosed-terminal Models

E52-P□□C-N-6

Dimensions

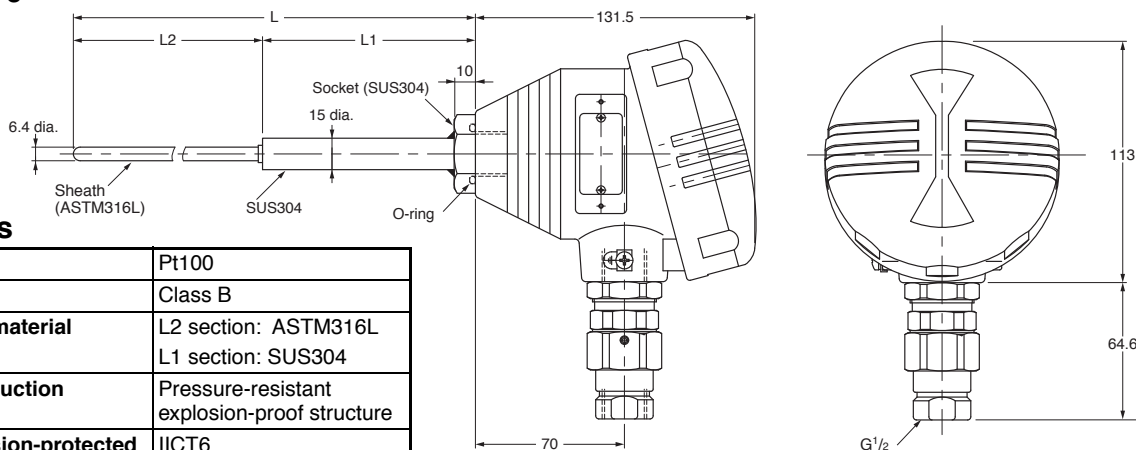

Specifications

Element type	Pt100	
Class	Class B	
Protective tubing material	L2 section: ASTM316L L1 section: SUS304	
Explosion-proof specifications	Construction	Pressure-resistant explosion-proof structure
	Explosion-protected class and ignitability	IICT6
	Explosion-proof temperature range	-20 C to 85 C
	Lead wire wiring method	Pressure-resistant packing cable ground type
	Conduit thread	G1/2
	Installation method	Conforms to Technical Recommendations of the Research Institute of Industrial Safety (Japan)

Model	Protective tubing length L (cm)	Protective tubing diameter	L2 (mm)
E52-P20C-N-6 D=6.4 L2=150	20	D = 6.4	150
E52-P35C-N-6 D=6.4 L2=300	35	D = 6.4	300
E52-P50C-N-6 D=6.4 L2=450	50	D = 6.4	450
E52-P75C-N-6 D=6.4 L2=700	75	D = 6.4	700

Double-element Models

■ Thermocouple

Exposed-lead Models

Specifications

Element type	K (CA)
Class	Class 2 (0.75)
Protective tubing material	ASTM316L (with sheath)
Thermal contact	Non-grounded type
Temperature range	0 C to permissible temperature limit
Lead wire	Vinyl-covered: -20 C to 70 C

E52-CA20AY-7

Dimensions

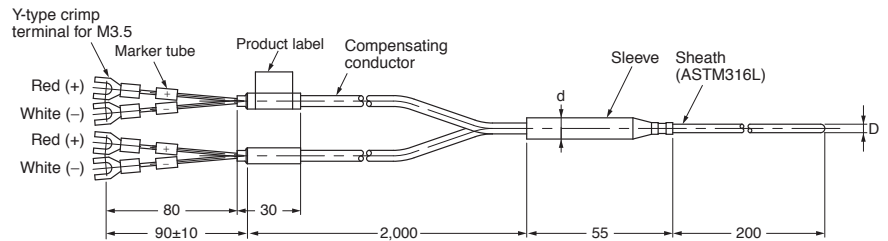

Permissible Temperature in Dry Air

D	Element wire
	K (CA) ASTM316L
3.2 dia.	750 C
4.8 dia.	800 C
6.4 dia.	800 C
8.0 dia.	900 C

Model	Protective tubing diameter	Sleeve diameter (mm)	Permissible Temperature (C)	Lead wire length (m)
E52-CA20AY-7 D=3.2 2M	D = 3.2	d = 11	750	2
E52-CA20AY-7 D=4.8 2M	D = 4.8	d = 11	800	2
E52-CA20AY-7 D=6.4 2M	D = 6.4	d = 11	800	2
E52-CA20AY-7 D=8.0 2M	D = 8.0	d = 11	900	2

■ Platinum Resistance Thermometers

Exposed-lead Models

Specifications

Element type	Pt100
Class	Class B
Protective tubing material	ASTM316L (with sheath)
Conductor type	3-conductor system
Temperature range	-200 C to 450 C
Lead wire	Vinyl-covered: -20 C to 70 C

E52-P20AY-7

Dimensions

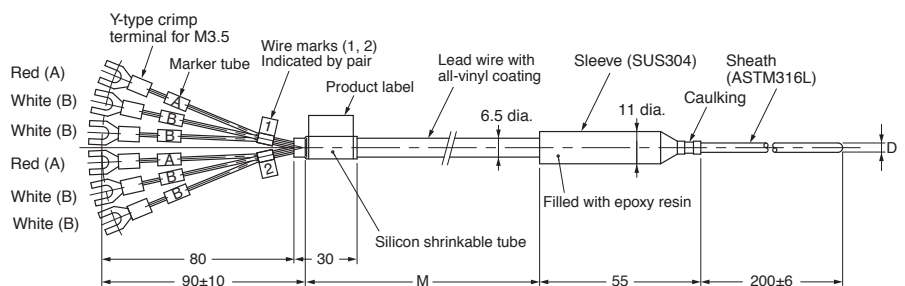

Model	Protective tubing diameter	Lead wire length (m)
E52-P20AY-7 D=4.8 2M	D = 4.8	2
E52-P20AY-7 D=6.4 2M	D = 6.4	2

Enclosed-terminal Models

Specifications

Element type	Pt100
Class	Class B
Protective tubing material	ASTM316L (with sheath)
Conductor type	3-conductor system
Temperature range	-200 C to 450 C

E52-P20C-N-7

Dimensions

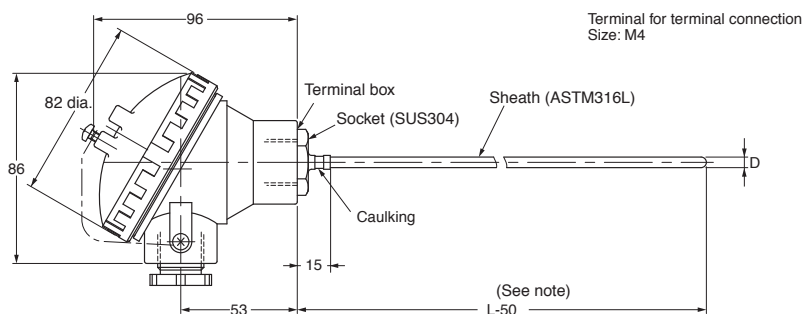

Model	Protective tubing length L (cm)	Protective tubing diameter
E52-P20C-N-7 D=4.8	20	D = 4.8
E52-P20C-N-7 D=6.4	20	D = 6.4

Note: The length L is in centimeters, but "50" is 50 millimeters.
Therefore, for the E52-P20C-N-7: L = 20 (cm), the sheath length L - 50 = 200 - 50 = 150 mm.

Silicone-covered Lead Wires Models

■ Thermocouples

Exposed-lead Models with Screws

Specifications

Element type	K (CA)
Class	Class 2 (0.75)
Screw material	SUS304
Thermal contact	Grounded type
Temperature range	0 C to 300 C
Lead wire	Silicone-covered (0.1/30): 0 C to 150 C
Terminal shape	Y-type crimp terminal for M3.5

Note: Refer to the installation example for the E52-CA1DY.

E52-CA1DY-40

Dimensions

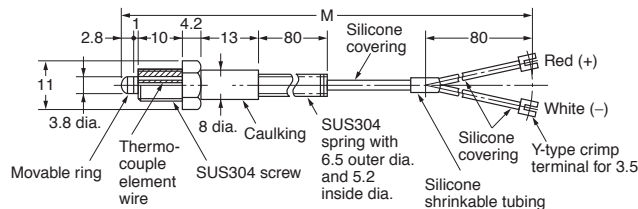

Model	Screw pitch	Lead wire length (m)
E52-CA1DY-40 M6 1M	M6	1
E52-CA1DY-40 M6 2M	M6	2
E52-CA1DY-40 M6 4M	M6	4

Thermocouples with Crimp Terminals

Specifications

Element type	K (CA)
Class	Class 2 (0.75)
Thermal contact	Grounded type
Temperature range	0 C to 200 C
Lead wire	Silicone-covered : 0 C to 150 C
Terminal shape	Y-type crimp terminal for M3.5

E52-CA1GTY-14

Dimensions

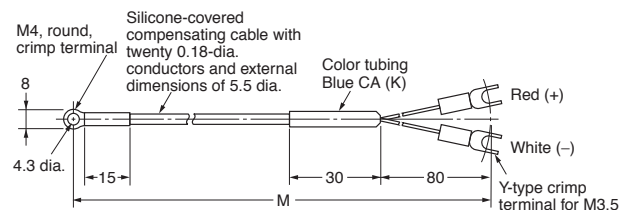

Lead wire length (M): 1 or 2 m

Model	Lead wire length (m)
E52-CA1GTY-14 1M	1
E52-CA1GTY-14 2M	2

Thermistors

Element Interchangeable Thermistor for E5CS and E5C2

Temperature Ranges

Temperature range	Color code	Nominal resistance	Thermistor constant	Lead wire
-50 C to 50 C	Blue	6 k Ω (0 C)	3390K	A pair of 0.12 dia. 7 Fluororesin-insulated stranded wires with 0.86 outer dia. each
0 C to 100 C	Black	6 k Ω (0 C)	3390K	
50 C to 150 C	Red	30 k Ω (0 C)	3450K	
100 C to 200 C	Yellow	0.55 k Ω (200 C)	4300K	
150 C to 300 C	Green	4 k Ω (200 C)	5133K	Flat glass-wool-shielded lead cable with 0.12 dia. 10 conductors and external dimensions of 2.5 \times 1.55

Specifications

Item	E52-THE□□
Coupling method	Element interchangeable thermistor
Class	JIS class 1
Protective tubing material	SUS304
Time constant	8 to 15 s in still water
Dissipation factor	2.4 to 2.8 mW/ C in still air
Lead wire heat resistive temperature	180 C

Error

Detectable temperature	Error
-50 C to 100 C	± 1 C max.
100 C to 350 C	$\pm 1\%$ max. of detectable temperature

Permissible Temperature

Detectable temperature	Operating temperature
-50 C to 50 C	100 C
0 C to 100 C	150 C
50 C to 150 C	200 C
100 C to 200 C	250 C
150 C to 300 C	350 C

Note: Models with non-standard lead wire length and protective tubing length are available on request.

This Thermistor is a dedicated Thermistor for the E5C2 and E5CS.

Exposed-lead Models

E52-THE5A

Dimensions

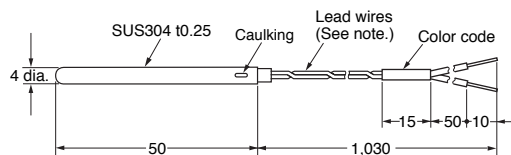

Note: The lead wires have no polarity

Temperature range	Model
-50 C to 50 C	E52-THE5A -50-50 C 1M
0 C to 100 C	E52-THE5A 0-100 C 1M
50 C to 150 C	E52-THE5A 50-150 C 1M
100 C to 200 C	E52-THE5A 100-200 C 1M
150 C to 300 C	E52-THE5A 150-300 C 1M

Exposed-lead Models with Screws

E52-THE6D

Dimensions

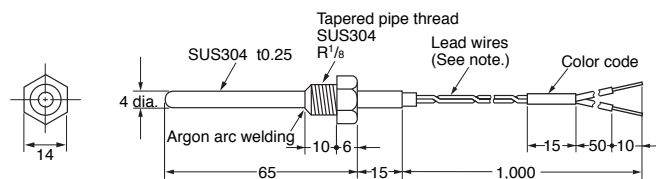

Note: The lead wires have no polarity

Temperature range	Model
-50 C to 50 C	E52-THE6D -50-50 C 1M
0 C to 100 C	E52-THE6D 0-100 C 1M
50 C to 150 C	E52-THE6D 50-150 C 1M
100 C to 200 C	E52-THE6D 100-200 C 1M
150 C to 300 C	E52-THE6D 150-300 C 1M

Exposed-lead Models with Flange

E52-THE6F

Dimensions

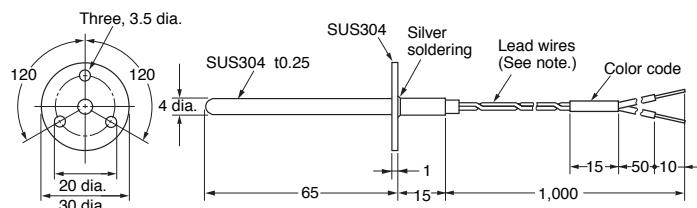

Note: The lead wires have no polarity

Temperature range	Model
-50 C to 50 C	E52-THE6F -50-50 C 1M
0 C to 100 C	E52-THE6F 0-100 C 1M
50 C to 150 C	E52-THE6F 50-150 C 1M
100 C to 200 C	E52-THE6F 100-200 C 1M
150 C to 300 C	E52-THE6F 150-300 C 1M

Note: 1. The Thermistor lead cable can be extended with a standard lead wire for extension. If waterproof performance is required, be sure that the lead cable joint is of waterproof construction as well.

2. Be sure to specify the model and temperature range when ordering the Thermistor. The Thermistor has a color code according to the temperature range.

Accessories

Compression Fittings

Model Information

Model	Screw of part a	Applicable protective tubing diameter	Dimension				
			b	c	d	Flat diameter	
						Part c	Part b
PT 1/8 D=1.0	R 1/8	1.0 dia.	5	13	10	14	14
PT 1/8 D=1.6		1.6 dia.					
PT 1/8 D=3.2		3.2 dia.					
PT 1/8 D=4.8		4.8 dia.					
PT 1/4 D=3.2	R 1/4	3.2 dia.	5	15	12	17	14
PT 1/4 D=4.8		4.8 dia.					
PT 1/4 D=6.4		6.4 dia.					
PT 3/8 D=8	R 3/8	8 dia.	5	19	15	21	17
PT 1/2 D=10	R 1/2	10 dia.	8	23.5	19.5	26	21
M 12 D=4.8	M 12	4.8 dia.	5	15	12	17	14

Note: The Compression Fitting is not of airtight construction. Do not use the Compression Fitting for applications in which the exposure of the sensing object will cause problems.

The compression fitting is a screw that adjusts and secures the insertion length of Temperature Sensors with the above protective tubing diameters.

The material of the Compression Fitting is SUS304 with internal fixing beads made of brass.

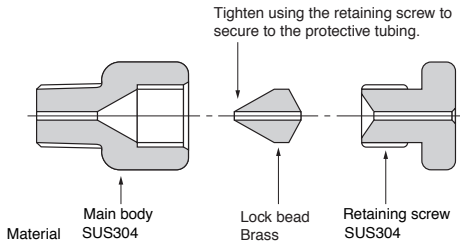
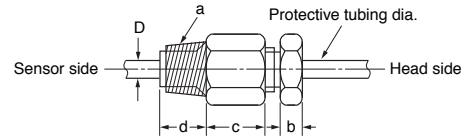

Source: JIS B 0203 (Unit: mm)

Nominal thread size	T.P.I. (No. of threads /inch)	Outer diameter: d	Effective diameter: d2	Root diameter: d1	Standard diameter position a (from pipe end)	Minimum effective screw length: f
PT 1/8	28	9.728	9.147	8.566	3.97 ±0.91	2.5
PT 1/4	19	13.157	12.301	11.445	6.01 ±1.34	3.7
PT 3/8	19	16.662	15.806	14.950	6.35 ±1.34	3.7
PT 1/2	14	20.955	19.793	18.631	8.16 ±1.81	5.0

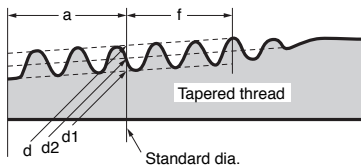

Loose Flanges

Model Information

Applicable protective tubing diameter	Model
3.2 dia.	MF-1 D=3.2
4.8 dia.	MF-1 D=4.8
6.4 dia.	MF-1 D=6.4
8 dia.	MF-1 D=8
10 dia.	MF-2 D=10
12 dia.	MF-2 D=12
15 dia.	MF-2 D=15
22 dia.	MF-2 D=22

- Note:**
1. Use the Loose Flange in atmospheric pressure. The Loose Flange is not of airtight construction.
 2. Use the Loose Flange at 400 C maximum.
 3. Do not apply the Loose Flange to protective tubing diameters other than the applicable ones.

Material: Aluminum

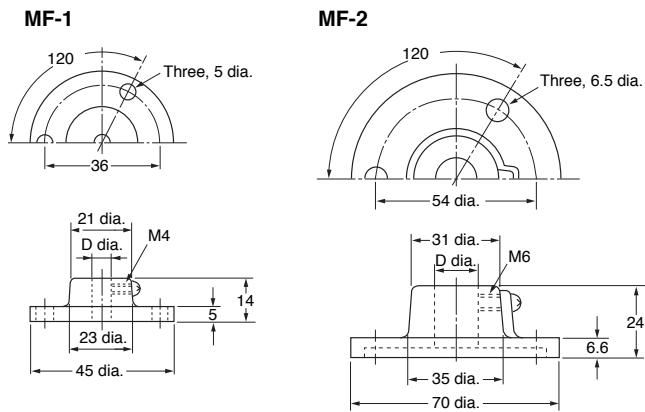

Compensating Conductors

The material of the Compensating Conductor is the same as or similar to that of the Thermocouple. Therefore, the Thermocouple can be connected to the Compensating Conductor just as if the length of the Thermocouple is to be extended. A standard model for a temperature range between -20 °C and 70 °C and two types of heat-resistive models for a temperature range between 0 °C and 150 °C are available.

Be sure to use the compensating conductor for the extension of the length of the thermocouple.

Model Information

Thermocouple	Heat resistance	Exterior (Length)	Model			
			1 m	2 m	4 m	8 m
R	Standard	Fully vinyl-covered (waterproof)	WPRG-N 1M	WPRG-N 2M	WPRG-N 4M	WPRG-N 8M
	Heat resistive	Fully glass-wool-covered	WPRH-N 1M	WPRH-N 2M	WPRH-N 4M	WPRH-N 8M
		Fully glass-wool-covered with external shield of stainless steel	WPRH6-N 1M	WPRH6-N 2M	WPRH6-N 4M	WPRH6-N 8M
K (CA)	Standard	Fully vinyl-covered (waterproof)	WCAG-N 1M	WCAG-N 2M	WCAG-N 4M	WCAG-N 8M
	Heat resistive	Fully glass-wool-covered	WCAH-N 1M	WCAH-N 2M	WCAH-N 4M	WCAH-N 8M
		Fully glass-wool-covered with external shield of stainless steel	WCAH6-N 1M	WCAH6-N 2M	WCAH6-N 4M	WCAH6-N 8M
		Silicone-covered (See note 2.)	WCAG-40 1M	WCAG-40 2M	WCAG-40 4M	WCAG-40 8M
J (IC)	Standard	Vinyl covered (waterproof)	WICG-N 1M	WICG-N 2M	WICG-N 4M	WICG-N 8M
	Heat resistive	Fully glass-wool-covered	WICH-N 1M	WICH-N 2M	WICH-N 4M	WICH-N 8M
		Fully glass-wool-covered with external shield of stainless steel	WICH6-N 1M	WICH6-N 2M	WICH6-N 4M	WICH6-N 8M

Note: 1. Compensating Conductors with lengths, increased in units of a meter, up to 100 meters are available on request. Specify lengths above 100 meters in units of 100 meters. The maximum length depends on the product. Contact your OMRON representative for details.

2. It has the same waterproof characteristics as the standard model (fully vinyl-covered) and can be used at high temperatures.

Specifications (JIS C1610-1995)

Model	Type of thermo-couple	Use	Code (See note.)	Exterior	Number of wires/wire diameter	Operating temperature range (°C)	Error (°C)	Exterior color
WPRG-N	R	Standard	RCA-2-G	Fully vinyl-covered (waterproof)	7/0.3	0 to 90	±30	Black
WPRH-N		Heat resistive	RCB-2-H	Fully glass-wool-covered	7/0.32	0 to 150	±60	
WPRH6-N				Fully glass-wool-covered with external shield of stainless steel				
WCAG-N	K (CA)	Standard	KCC-2-G	Fully vinyl-covered (waterproof)	7/0.3	0 to 90	±100	Blue
WCAH-N		Heat resistive	KCB-2-H	Fully glass-wool-covered	7/0.32	0 to 150		
WCAH6-N				Fully glass-wool-covered with external shield of stainless steel				
WCAG-40		Heat resistive for moving parts	KX-2-G	Silicone-covered	30/0.1	-20 to 150	±100	
WICG-N	J (IC)	Standard	JX-2-G	Fully vinyl-covered (waterproof)	7/0.3	-20 to 90	±140	Yellow
WICH-N		Heat resistive	JX-2-H	Fully glass-wool-covered	7/0.32	0 to 150		
WICH6-N				Fully glass-wool-covered with external shield of stainless steel				

Note: Symbols conform to JIS standards.

For code having duplicate exterior, check the application and check in our models.

ALL DIMENSIONS SHOWN ARE IN MILLIMETERS.

To convert millimeters into inches, multiply by 0.03937. To convert grams into ounces, multiply by 0.03527.

In the interest of product improvement, specifications are subject to change without notice.

Terms and Conditions of Sale

1. **Offer; Acceptance.** These terms and conditions (these "**Terms**") are deemed part of all quotes, agreements, purchase orders, acknowledgments, price lists, catalogs, manuals, brochures and other documents, whether electronic or in writing, relating to the sale of products or services (collectively, the "**Products**") by Omron Electronics LLC and its subsidiary companies ("**Omron**"). Omron objects to any terms or conditions proposed in Buyer's purchase order or other documents which are inconsistent with, or in addition to, these Terms.
2. **Prices; Payment Terms.** All prices stated are current, subject to change without notice by Omron. Omron reserves the right to increase or decrease prices on any unshipped portions of outstanding orders. Payments for Products are due net 30 days unless otherwise stated in the invoice.
3. **Discounts.** Cash discounts, if any, will apply only on the net amount of invoices sent to Buyer after deducting transportation charges, taxes and duties, and will be allowed only if (i) the invoice is paid according to Omron's payment terms and (ii) Buyer has no past due amounts.
4. **Interest.** Omron, at its option, may charge Buyer 1-1/2% interest per month or the maximum legal rate, whichever is less, on any balance not paid within the stated terms.
5. **Orders.** Omron will accept no order less than \$200 net billing.
6. **Governmental Approvals.** Buyer shall be responsible for, and shall bear all costs involved in, obtaining any government approvals required for the importation or sale of the Products.
7. **Taxes.** All taxes, duties and other governmental charges (other than general real property and income taxes), including any interest or penalties thereon, imposed directly or indirectly on Omron or required to be collected directly or indirectly by Omron for the manufacture, production, sale, delivery, importation, consumption or use of the Products sold hereunder (including customs duties and sales, excise, use, turnover and license taxes) shall be charged to and remitted by Buyer to Omron.
8. **Financial.** If the financial position of Buyer at any time becomes unsatisfactory to Omron, Omron reserves the right to stop shipments or require satisfactory security or payment in advance. If Buyer fails to make payment or otherwise comply with these Terms or any related agreement, Omron may (without liability and in addition to other remedies) cancel any unshipped portion of Products sold hereunder and stop any Products in transit until Buyer pays all amounts, including amounts payable hereunder, whether or not then due, which are owing to it by Buyer. Buyer shall in any event remain liable for all unpaid accounts.
9. **Cancellation; Etc.** Orders are not subject to rescheduling or cancellation unless Buyer indemnifies Omron against all related costs or expenses.
10. **Force Majeure.** Omron shall not be liable for any delay or failure in delivery resulting from causes beyond its control, including earthquakes, fires, floods, strikes or other labor disputes, shortage of labor or materials, accidents to machinery, acts of sabotage, riots, delay in or lack of transportation or the requirements of any government authority.
11. **Shipping; Delivery.** Unless otherwise expressly agreed in writing by Omron:
 - a. Shipments shall be by a carrier selected by Omron; Omron will not drop ship except in "break down" situations.
 - b. Such carrier shall act as the agent of Buyer and delivery to such carrier shall constitute delivery to Buyer;
 - c. All sales and shipments of Products shall be FOB shipping point (unless otherwise stated in writing by Omron), at which point title and risk of loss shall pass from Omron to Buyer; provided that Omron shall retain a security interest in the Products until the full purchase price is paid;
 - d. Delivery and shipping dates are estimates only; and
 - e. Omron will package Products as it deems proper for protection against normal handling and extra charges apply to special conditions.
12. **Claims.** Any claim by Buyer against Omron for shortage or damage to the Products occurring before delivery to the carrier must be presented in writing to Omron within 30 days of receipt of shipment and include the original transportation bill signed by the carrier noting that the carrier received the Products from Omron in the condition claimed.
13. **Warranties.** (a) **Exclusive Warranty.** Omron's exclusive warranty is that the Products will be free from defects in materials and workmanship for a period of twelve months from the date of sale by Omron (or such other period expressed in writing by Omron). Omron disclaims all other warranties, express or implied. (b) **Limitations.** OMRON MAKES NO WARRANTY OR REPRESENTATION, EXPRESS OR IMPLIED, ABOUT NON-INFRINGEMENT, MERCHANTABILITY OR FITNESS FOR A PARTICULAR PURPOSE OF THE PRODUCTS. BUYER ACKNOWLEDGES THAT IT ALONE HAS DETERMINED THAT THE PRODUCTS WILL SUITABLY MEET THE REQUIREMENTS OF THEIR INTENDED USE. Omron further disclaims all warranties and responsibility of any type for claims or expenses based on infringement by the Products or otherwise of any intellectual property right. (c) **Buyer Remedy.** Omron's sole obligation hereunder shall be, at Omron's election, to (i) replace (in the form originally shipped with Buyer responsible for labor charges for removal or replacement thereof) the non-complying Product, (ii) repair the non-complying Product, or (iii) repay or credit Buyer an amount equal to the purchase price of the non-complying Product; provided that in no event shall Omron be responsible for warranty, repair, indemnity or any other claims or expenses regarding the Products unless Omron's analysis confirms that the Products were properly handled, stored, installed and maintained and not subject to contamination, abuse, misuse or inappropriate modification. Return of any Products by Buyer must be approved in writing by Omron before shipment. Omron Companies shall not be liable for the suitability or unsuitability or the results from the use of Products in combination with any electrical or electronic components, circuits, system assemblies or any other materials or substances or environments. Any advice, recommendations or information given orally or in writing, are not to be construed as an amendment or addition to the above warranty. See <http://www.omron247.com> or contact your Omron representative for published information.
14. **Limitation on Liability; Etc.** OMRON COMPANIES SHALL NOT BE LIABLE FOR SPECIAL, INDIRECT, INCIDENTAL, OR CONSEQUENTIAL DAMAGES, LOSS OF PROFITS OR PRODUCTION OR COMMERCIAL LOSS IN ANY WAY CONNECTED WITH THE PRODUCTS, WHETHER SUCH CLAIM IS BASED IN CONTRACT, WARRANTY, NEGLIGENCE OR STRICT LIABILITY. Further, in no event shall liability of Omron Companies exceed the individual price of the Product on which liability is asserted.
15. **Indemnities.** Buyer shall indemnify and hold harmless Omron Companies and their employees from and against all liabilities, losses, claims, costs and expenses (including attorney's fees and expenses) related to any claim, investigation, litigation or proceeding (whether or not Omron is a party) which arises or is alleged to arise from Buyer's acts or omissions under these Terms or in any way with respect to the Products. Without limiting the foregoing, Buyer (at its own expense) shall indemnify and hold harmless Omron and defend or settle any action brought against such Companies to the extent based on a claim that any Product made to Buyer specifications infringed intellectual property rights of another party.
16. **Property; Confidentiality.** Any intellectual property in the Products is the exclusive property of Omron Companies and Buyer shall not attempt to duplicate it in any way without the written permission of Omron. Notwithstanding any charges to Buyer for engineering or tooling, all engineering and tooling shall remain the exclusive property of Omron. All information and materials supplied by Omron to Buyer relating to the Products are confidential and proprietary, and Buyer shall limit distribution thereof to its trusted employees and strictly prevent disclosure to any third party.
17. **Export Controls.** Buyer shall comply with all applicable laws, regulations and licenses regarding (i) export of products or information; (ii) sale of products to "forbidden" or other proscribed persons; and (iii) disclosure to non-citizens of regulated technology or information.
18. **Miscellaneous.** (a) **Waiver.** No failure or delay by Omron in exercising any right and no course of dealing between Buyer and Omron shall operate as a waiver of rights by Omron. (b) **Assignment.** Buyer may not assign its rights hereunder without Omron's written consent. (c) **Law.** These Terms are governed by the law of the jurisdiction of the home office of the Omron company from which Buyer is purchasing the Products (without regard to conflict of law principles). (d) **Amendment.** These Terms constitute the entire agreement between Buyer and Omron relating to the Products, and no provision may be changed or waived unless in writing signed by the parties. (e) **Severability.** If any provision hereof is rendered ineffective or invalid, such provision shall not invalidate any other provision. (f) **Setoff.** Buyer shall have no right to set off any amounts against the amount owing in respect of this invoice. (g) **Definitions.** As used herein, "including" means "including without limitation"; and "Omron Companies" (or similar words) mean Omron Corporation and any direct or indirect subsidiary or affiliate thereof.

Certain Precautions on Specifications and Use

1. **Suitability of Use.** Omron Companies shall not be responsible for conformity with any standards, codes or regulations which apply to the combination of the Product in the Buyer's application or use of the Product. At Buyer's request, Omron will provide applicable third party certification documents identifying ratings and limitations of use which apply to the Product. This information by itself is not sufficient for a complete determination of the suitability of the Product in combination with the end product, machine, system, or other application or use. Buyer shall be solely responsible for determining appropriateness of the particular Product with respect to Buyer's application, product or system. Buyer shall take application responsibility in all cases but the following is a non-exhaustive list of applications for which particular attention must be given: (i) Outdoor use, uses involving potential chemical contamination or electrical interference, or conditions or uses not described in this document. (ii) Use in consumer products or any use in significant quantities. (iii) Energy control systems, combustion systems, railroad systems, aviation systems, medical equipment, amusement machines, vehicles, safety equipment, and installations subject to separate industry or government regulations. (iv) Systems, machines and equipment that could present a risk to life or property. Please know and observe all prohibitions of use applicable to this Product. NEVER USE THE PRODUCT FOR AN APPLICATION INVOLVING SERIOUS RISK TO LIFE OR PROPERTY OR IN LARGE QUANTITIES WITHOUT ENSURING THAT THE SYSTEM AS A WHOLE HAS BEEN DESIGNED TO ADDRESS THE RISKS, AND THAT THE OMRON'S PRODUCT IS PROPERLY RATED AND INSTALLED FOR THE INTENDED USE WITHIN THE OVERALL EQUIPMENT OR SYSTEM.
2. **Programmable Products.** Omron Companies shall not be responsible for the user's programming of a programmable Product, or any consequence thereof.
3. **Performance Data.** Data presented in Omron Company websites, catalogs and other materials is provided as a guide for the user in determining suitability and does not constitute a warranty. It may represent the result of Omron's test conditions, and the user must correlate it to actual application requirements. Actual performance is subject to the Omron's Warranty and Limitations of Liability.
4. **Change in Specifications.** Product specifications and accessories may be changed at any time based on improvements and other reasons. It is our practice to change part numbers when published ratings or features are changed, or when significant construction changes are made. However, some specifications of the Product may be changed without any notice. When in doubt, special part numbers may be assigned to fix or establish key specifications for your application. Please consult with your Omron's representative at any time to confirm actual specifications of purchased Product.
5. **Errors and Omissions.** Information presented by Omron Companies has been checked and is believed to be accurate; however, no responsibility is assumed for clerical, typographical or proofreading errors or omissions.