

# E-Series

Hydraulic-Magnetic Circuit Breaker

**PRODUCT WEBPAGE**

*request sample, configure part*

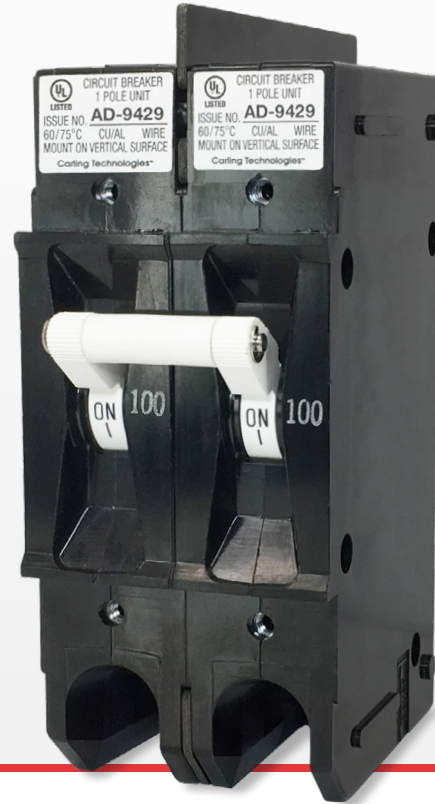

## High Current and Voltage Breaker Qualified Supplementary Protector

The E-Series hydraulic-magnetic circuit breaker is designed for higher current and voltage applications and qualified, as per agency approval, for branch circuit protection or as a supplementary protector. E-Series breakers are available as a one to six pole configuration and are rated up to 125 amps and 600VAC or 125VDC, with a max IC of 10,000 amps.

|            |              |            |            |
|------------|--------------|------------|------------|
| <b>1-6</b> | <b>1-100</b> | <b>600</b> | <b>125</b> |
| Poles      | Amps         | VAC Max    | VDC Max    |

## Typical Applications

- Renewable Energy
- Industrial Automation
- High Voltage/Current Applications
- Military
- Generators
- Commercial Food

# Tech Specs

## Electrical

|                         |   |
|-------------------------|---|
| Maximum Voltage         | 600VAC 50/60 Hz, 125VDC (See Table A)   |
| Current Ratings         | Standard current coils: 0.100, 0.250, 0.500, 1.00, 2.50, 5.00, 7.50, 10.0, 15.0, 20.0, 25.0, 30.0, 50.0, 60.0, 70.0 & 100 Amp.  |
| Auxiliary Switch Rating | SPDT; 10.1A 250VAC, 1.0A 65VDC; 0.5A 80VDC, 0.1A 125VAC (with gold contacts).   |
| Insulation Resistance   | Minimum of 100 Megohms at 500 VDC.  |
| Dielectric Strength     | UL, CSA: 2200 V 50/60 Hz for one minute between all electrically isolated terminals. E-Series Circuit Breakers comply with the 8mm spacing and 3750V 50/60 Hz dielectric requirements from hazardous voltage to operator accessible surfaces, between adjacent poles and from main circuits to auxiliary circuits per Publications EN 60950 and VDE 0805. |
| Resistance, Impedance   | Values from Line to Load Terminal - based on Series Trip Circuit Breaker  |

RESISTANCE, IMPEDANCE VALUES  
from Line to Load Terminals  
(Values Based on Series Trip Circuit Breaker)

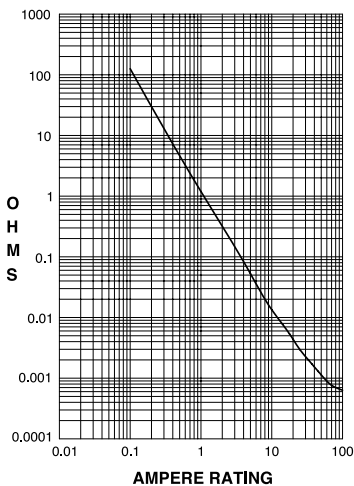

| CURRENT (AMPS) | TOLERANCE (%) |
|----------------|---------------|
| 0.10 - 5.0     | ± 15          |
| 5.1 - 20.0     | ± 25          |
| 20.1 - 50.0    | ± 35          |

## Pulse Tolerance Curves

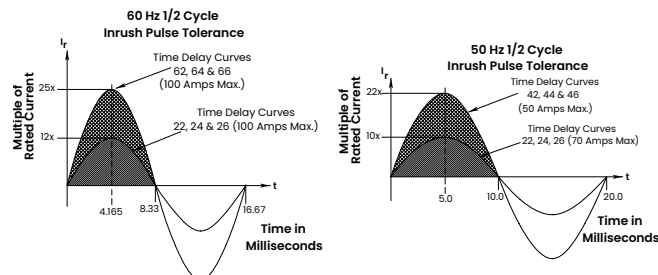

## Mechanical

|                 |  |
|-----------------|--|
| Endurance       | 10,000 ON-OFF operations @ 6 per minute; with rated current & voltage.                                     |
| Trip Free       | All E-Series circuit breakers will trip on overload, even when Handle is forcibly held in the ON position. |
| Trip Indication | The operating Handle moves positively to the OFF position when an overload causes the breaker to trip.     |

## Physical

|  |  |
|--|--|
| Number of Poles  | 1-6  |
| Mounting   | A 3" minimum spacing must be provided between the circuit breaker arc venting area on back connected E-Series circuit breakers and grounded obstructions. E-Series circuit breakers must be mounted on a vertical surface. |
| Connectors, Box Type   | Front connected E-Series circuit breakers are supplied with box type pressure connectors that accept copper or aluminum conductors as follows: 1/0-14 Copper, 1/0-12 Aluminum.   |
| Internal Circuit Configuration   | Series and Switch Only, (with or Configuration without auxiliary switch). Shunt with current coils.  |
| Weight   | Approximately 252 grams/pole (Approximately 9 ounces/pole)   |
| Standard Colors  | Housing-Black; Actuator - See Ordering Scheme.   |
| <b>Environmental</b>   |  |
| Designed in accordance with requirements of specification MIL PRF-55629 & MIL-STD-202G as follows: |  |
| Shock  | Withstands 100 Gs, 6ms, sawtooth while carrying rated current per Method 213, Test Condition "I".  |
| Vibration  | Withstands 0.060" excursion from 10-55 Hz, and 10 Gs 55-500 Hz, at rated current per Method 204C, Test Condition A.  |
| Moisture Resistance  | Method 106D, i.e., ten 24-hour cycles @ + 25°C to +65°C, 80-98% RH.  |
| Salt Spray   | Method 101, Condition A (90-95% RH @ 5% NaCl Solution, 96 hrs).  |
| Thermal Shock  | Method 107D, Condition A (Five cycles @ -55°C to +25°C to +85°C to +25°C).   |
| Operating Temperature  | -40° C to +85° C   |

# Tech Specs

## Tables

**Table A:** Lists UL Listed (489) & CSA Certified (C22.2 No. 5) configurations & performance capabilities as a Molded Case Circuit Breaker.

| UL489 Listed Branch Circuit Breakers |            |            |       |                |                              |                                   |
|--------------------------------------|------------|------------|-------|----------------|------------------------------|-----------------------------------|
| Circuit Configuration                | Voltage    |            |       | Current Rating | Interrupting Capacity (Amps) | High Interrupting Capacity (Amps) |
|                                      | Max Rating | Frequency  | Phase | Full Load Amps | Without Backup Fuse          |                                   |
| Series                               | 80         | DC         | -     | 0.10 - 100     | 5,000                        | 50,000                            |
|                                      | 125        |            | -     |                |                              | 10,000                            |
|                                      | 120        |            | -     | -              |                              |                                   |
|                                      | 240        | 50/60      | 1     | 0.10 - 125     | 5,000                        | -                                 |
|                                      | 120 / 240  |            |       | 0.10 - 30      |                              | 10,000                            |
|                                      |            |            |       | 31 - 100       |                              | -                                 |
|                                      |            |            |       | 0.10 - 30      |                              | 10,000                            |
|                                      |            |            |       | 31 - 100       |                              | -                                 |
|                                      | 240        |            |       | 3              |                              | 101 - 125                         |
|                                      | 240        | 0.10 - 100 | 5,000 |                | -                            |                                   |

**Table B:** Lists UL Recognized & CSA Accepted configurations & performance capabilities as a Component Supplementary Protector.

| Component Supplementary Protectors |                  |           |       |                |                      |                               |                     |                   |                |
|------------------------------------|------------------|-----------|-------|----------------|----------------------|-------------------------------|---------------------|-------------------|----------------|
| Circuit Configuration              | Voltage          |           |       | Current Rating |                      | Short Circuit Capacity (Amps) |                     | Application Codes |                |
|                                    | Max Rating       | Frequency | Phase | Full Load Amps | General Purpose Amps | UL/CSA                        |                     | UL                | CSA            |
|                                    |                  |           |       |                |                      | With Backup Fuse              | Without Backup Fuse |                   |                |
| Series & Shunt                     | 125              | DC        | -     | 0.02 - 100     | -                    | -                             | 5,000               | TC1,2, OLI, UI    | TC1,2, OLI, UI |
|                                    | 125              |           |       | -              | 101 - 120            |                               |                     | TC1,2, OL0, UI    | TC1,2, OL0, UI |
|                                    | 150              |           |       | 0.02 - 125     | TC1, OL0, U3         |                               |                     | TC1, OL0, U3      |                |
|                                    | 160              |           |       | -              | TC1,2, OLI, UI       |                               |                     | TC1,2, OLI, UI    |                |
|                                    | 150 / 300        |           |       | -              | TC1,2, OLI, UI       |                               |                     | TC1,2, OLI, UI    |                |
|                                    | 120 / 240        | 50/60     | 1     | -              | 0.02 - 100           | -                             | 10,000              | TC1,2, OLI, UI    | TC1,2, OLI, UI |
|                                    | 240              |           |       | TC1,2, OL0, UI | TC1,2, OL0, UI       |                               |                     |                   |                |
|                                    | 250              |           |       | TC1,2, OLI, UI | TC1,2, OLI, UI       |                               |                     |                   |                |
|                                    | 277              |           |       | 0.02 - 100     | TC1,2, OLI, C1       |                               |                     | TC1,2, OLI, C1    |                |
|                                    | 480              |           |       | -              | TC1,2, OLI, UI       |                               |                     | TC1,2, OLI, UI    |                |
|                                    | 480 <sup>1</sup> |           |       | 1 & 3          | 0.02 - 50            |                               |                     | TC1,2, OLI, C1    | TC1,2, OLI, C1 |
|                                    | 600              |           |       |                | 0.02 - 100           |                               |                     | TC1,2, OLI, C1    | TC1,2, OLI, C1 |
|                                    | 600 <sup>2</sup> |           |       |                | -                    |                               |                     | 0.02 - 125        | TC1, OL0, U3   |
| Switch Only                        | 125              | DC        | -     | 0.02 - 120     | -                    | -                             | 5,000               | -                 | -              |
|                                    | 160              | 50/60     | 1     |                |                      |                               |                     |                   |                |
|                                    | 240              |           |       |                |                      |                               |                     |                   |                |
|                                    | 277              |           |       |                |                      |                               |                     |                   |                |
|                                    | 480              |           |       |                |                      |                               |                     |                   |                |
|                                    | 600              |           |       |                |                      |                               |                     |                   |                |

**Notes:**

- 1 Per pole opposite polarity rating - Delta Configuration.
- 2 4 Poles connected in series
- 3 Requires branch circuit backup with a UL Listed Type K5 or RK5 fuse rated 15A minimum and no more than 4 times full load amp rating and not to exceed 225A.

# Tech Specs

**Table C:** Lists UL Recognized, CSA Accepted and VDE Certified configurations and performance capabilities as a Component Supplementary Protector.

| Component Supplementary Protectors With VDE |            |           |       |                                  |                               |                     |  |                   |                |  |
|---|------------|-----------|-------|----------------------------------|-------------------------------|---------------------|--|-------------------|----------------|--|
| Circuit Configuration                       | Voltage    |           |       | Current Rating<br>Full Load Amps | Short Circuit Capacity (Amps) |                     |  | Application Codes |                | Construction Notes                               |
|   | Max Rating | Frequency | Phase |                                  | UL/CSA                        |                     | VDE (Icn)  | UL                | CSA            |  |
|   |            |           |       | With Backup Fuse                 | Without Backup Fuse           | Without Backup Fuse |  |                   |                |  |
| Series & Shunt                              | 125        | DC        | -     | 0.1 - 100                        | -                             | 5,000               | 5,000  | TC1,2, OLI, UI    | TC1,2, OLI, UI | 1 or 2 Poles                                     |
|   | 240        | 50/60     | 1 & 3 |                                  | 10,000                        | -                   | 4,000  | TC1,2, OLI, CI    | TC1,2, OLI, CI | 1-5 poles. Up to 4 Current Poles, 1 Voltage Pole |
|   | 415        |           |       |                                  | TC1,2, OLI, CI                | TC1,2, OLI, CI      | 2-5 poles. Up to 4 Current Poles, 1 Voltage Pole |                   |                |  |
| Switch Only                                 | 125        | DC        | -     | 0.1 - 125                        |                               |                     |  |                   |                |  |
|   | 240        | 50/60     | 1 & 3 | 0.1 - 100                        |                               |                     |  |                   |                |  |
|   | 415        |           |       |                                  |                               |                     |  |                   |                |  |

Notes:  
 1 Requires branch circuit backup with a UL LISTED Type K5 or RK5 fuse rated 15A minimum and no more than 4 times full load amp rating and not to exceed 225 amps.

**Table D:** Lists UL Recognized, CSA Accepted configurations and performance capabilities as Protectors, Supplementary for Marine Electrical and Fuel Systems (Guide PEQZ2, File E75596). Ignition Protected per UL 1500. UL Classified Small Craft Electrical Devices, Marine in accordance with ISO 8846 (Guide UZMK, File MQ1515) as Marine Supplementary Protectors.

| UL1500 (Marine Ignition Protection) |            |           |       |                                  |   |                   |                |
|-------------------------------------|------------|-----------|-------|----------------------------------|---|-------------------|----------------|
| Circuit Configuration               | Voltage    |           |       | Current Rating<br>Full Load Amps | Short Circuit Capacity (Amps)<br>With Backup Fuse | Application Codes |                |
|                                     | Max Rating | Frequency | Phase |                                  |   | UL                | CSA            |
| Series                              | 65         | DC        | -     | 0.2 - 100                        | 5,000   | TC1,2, OLI, UI    | TC1,2, OLI, UI |
|                                     | 125        | 50/60     | 1     |                                  | 1,500   |                   |                |
|                                     | 250        |           |       |                                  |   |                   |                |

## Agency Approvals

|               |   |
|---------------|---|
| UL 1077       | Component Recognition Program as Protectors, Supplementary (Guide QVNU2, File E75596)                         |
| UL 1500       | Component Recognition Program as Manual Motor Controls (Guide NLRV2, File E135367)                            |
| UL 489        | Protectors, Supplementary for Marine Electrical & Fuel Systems (Guide PEQZ2, File E75596) Ignition Protection |
| CSA Accepted  | Component Supplementary Protector (Class 3215 30, File 047848 0 000) CSA Standard C22.2 No. 235               |
| CSA Certified | Circuit Breaker Molded Case (Class 1432 01, File 093910), CSA Standard C22.2 No. 5.1 - M                      |
| TUV Certified | EN60934 under License No. R72031056   |
| VDE Certified | EN60934, VDE 0642 under File No. 10537  |

## Time Delay Specs

To view all hydraulic-magnetic circuit breaker time delay values, please visit [www.carlingtech.com/sites/default/files/documents/Carling-HM-CB-Time-Delays.pdf](http://www.carlingtech.com/sites/default/files/documents/Carling-HM-CB-Time-Delays.pdf)

# Ordering Scheme

UL 1077 Recognized

Sample Part Number

**E A 2 - B 0 - 24 - 450 - 1 2 A - C B**

Selection 1 2 3 4 5 6 7 8 9 10 11 12

## 1. SERIES

E

## 2. ACTUATOR

A Handle, one per pole

## 3. POLES <sup>1</sup>

|       |         |        |
|-------|---------|--------|
| 1 One | 3 Three | 5 Five |
| 2 Two | 4 Four  | 6 Six  |

## 4. CIRCUIT <sup>2</sup>

|                                      |                        |
|--------------------------------------|------------------------|
| A Switch Only (no coil) <sup>3</sup> | E Shunt Trip (voltage) |
| B Series Trip (current)              | F Relay Trip (current) |
| C Series Trip (voltage)              | G Relay Trip (voltage) |
| D Shunt Trip (current)               |                        |

## 5 AUXILIARY SWITCH <sup>4</sup>

|   |   |
|---|---|
| 0 without Auxiliary Switch                      | 6 S.P.S.T. 0.110 Q.C. Terminals                 |
| 2 S.P.D.T. 0.110 Q.C. Terminals                 | 7 S.P.S.T. 0.110 Q.C. Terminals (Gold Contacts) |
| 3 S.P.D.T. 0.139 Solder Lug                     | 8 S.P.S.T. 0.187 Q.C. Terminals                 |
| 4 S.P.D.T. 0.110 Q.C. Terminals (Gold Contacts) | 9 S.P.D.T. 0.187 Q.C. Terminals                 |

## 6. FREQUENCY & DELAY

|   |   |
|---|---|
| 03 DC 50/60Hz, Switch Only <sup>3</sup> | 36 DC, 50/60Hz Long                             |
| 10 DC Instantaneous <sup>5</sup>        | 62 50/60Hz Short, High-inrush                   |
| 12 DC Short                             | 64 50/60Hz Medium, High-inrush                  |
| 14 DC Medium                            | 66 50/60Hz Long, High-inrush                    |
| 16 DC Long                              | 74 DC, Medium, High-inrush                      |
| 20 50/60Hz Instantaneous <sup>5</sup>   | 76 DC, Long, High-inrush                        |
| 22 50/60Hz Short                        | 92 DC, 50/60Hz Short, High-inrush <sup>6</sup>  |
| 24 50/60Hz Medium                       | 94 DC, 50/60Hz Medium, High-inrush <sup>6</sup> |
| 26 50/60Hz Long                         | 96 DC, 50/60Hz Long, High-inrush <sup>6</sup>   |
| 30 DC, 50/60Hz Instantaneous            |   |
| 32 DC, 50/60Hz Short                    |   |
| 34 DC, 50/60Hz Medium                   |   |

## 7. CURRENT RATING (AMPERES) <sup>4</sup>

| CODE | AMPERES |     |       |     |        |     |                      |
|------|---------|-----|-------|-----|--------|-----|----------------------|
| 020  | 0.020   | 235 | 0.350 | 430 | 3.000  | 614 | 14.000               |
| 025  | 0.025   | 240 | 0.400 | 435 | 3.500  | 615 | 15.000               |
| 030  | 0.030   | 245 | 0.450 | 440 | 4.000  | 616 | 16.000               |
| 035  | 0.035   | 250 | 0.500 | 445 | 4.500  | 617 | 17.000               |
| 040  | 0.040   | 255 | 0.550 | 450 | 5.000  | 618 | 18.000               |
| 045  | 0.045   | 260 | 0.600 | 455 | 5.500  | 620 | 20.000               |
| 050  | 0.050   | 265 | 0.650 | 460 | 6.000  | 622 | 22.000               |
| 055  | 0.055   | 270 | 0.700 | 465 | 6.500  | 624 | 24.000               |
| 060  | 0.060   | 275 | 0.750 | 470 | 7.000  | 625 | 25.000               |
| 065  | 0.065   | 280 | 0.800 | 475 | 7.500  | 630 | 30.000               |
| 070  | 0.070   | 285 | 0.850 | 480 | 8.000  | 635 | 35.000               |
| 075  | 0.075   | 290 | 0.900 | 485 | 8.500  | 640 | 40.000               |
| 080  | 0.080   | 295 | 0.950 | 490 | 9.000  | 650 | 50.000               |
| 085  | 0.085   | 410 | 1.000 | 495 | 9.500  | 660 | 60.000               |
| 090  | 0.090   | 512 | 1.250 | 610 | 10.000 | 670 | 70.000               |
| 090  | 0.095   | 415 | 1.500 | 710 | 10.500 | 680 | 80.000               |
| 210  | 0.100   | 517 | 1.750 | 611 | 11.000 | 690 | 90.000               |
| 215  | 0.150   | 420 | 2.000 | 711 | 11.500 | 810 | 100.000              |
| 220  | 0.200   | 522 | 2.250 | 612 | 12.000 | 811 | 110.000              |
| 225  | 0.250   | 425 | 2.500 | 712 | 12.500 | 812 | 120.000              |
| 230  | 0.300   | 527 | 2.750 | 613 | 13.000 | 912 | 125.000 <sup>8</sup> |

## OR VOLTAGE COIL <sup>5</sup>

| CODE | RATING | TRIP VOLTS |     |       |       |     |       |       |
|------|--------|------------|-----|-------|-------|-----|-------|-------|
| A06  | 6DC    | 5DC        | A65 | 65DC  | 55DC  | J48 | 48AC  | 40AC  |
| A12  | 12DC   | 10DC       | B25 | 120DC | 100DC | J65 | 65AC  | 55AC  |
| A18  | 18DC   | 15DC       | J06 | 6AC   | 5AC   | K20 | 120AC | 65AC  |
| A24  | 24DC   | 20DC       | J12 | 12AC  | 10AC  | L40 | 240AC | 130AC |
| A32  | 32DC   | 25DC       | J18 | 18AC  | 15AC  |     |       |       |
| A48  | 48DC   | 40DC       | J24 | 24AC  | 20AC  |     |       |       |

Configure Complete Part Number >

Browse Standard Parts >

## 8. TERMINAL <sup>12</sup>

|                                     | BACK CONNECTED (FRONT MOUNTED ONLY)   | MAX. RATING |
|-------------------------------------|---|-------------|
| 1 <sup>9</sup>                      | 10-32 Stud (All Terminals)  | 50 A        |
| 2 <sup>9</sup>                      | 1/4-20 Stud (All Terminals)   | 120 A       |
| A <sup>9</sup>                      | M5 Stud (Line & Load)   | 50 A        |
| B <sup>9</sup>                      | M6 Stud (Line & Load)   | 100 A       |
| FRONT CONNECTED (BACK MOUNTED ONLY) |   |             |
| 3 <sup>10</sup>                     | Box Wire Connector (Line & Load)  | 100 A       |
| C <sup>11</sup>                     | Box Wire Connector with Pressure Plate (Line & Load)                          | 100 A       |
| 4                                   | 10-32 Screw (Line & Load)   | 50 A        |
| D                                   | M5 Screw (Line & Load)  | 50 A        |
| 5                                   | 10-32 "Bus-Type" Screw (Line), 10-32 Screw (Load)                             | 50 A        |
| E                                   | M5 "Bus-Type" Screw (Line), 10-32 Screw (Load)                                | 50 A        |
| 6 <sup>10</sup>                     | 10-32 "Bus-Type" Screw (Line), Box Wire Connector (Load)                      | 100 A       |
| F <sup>11</sup>                     | 10-32 "Bus-Type" Screw (Line), Box Wire Connector with Pressure Plate (Load)  | 100 A       |
| 7                                   | 1/4-20 Screw (Line & Load)  | 100 A       |
| G                                   | M6 Screw (Line & Load)  | 100 A       |
| 8                                   | 1/4-20 "Bus-Type" Screw (Line), 1/4-20 Screw (Load)                           | 100 A       |
| H                                   | M6 "Bus-Type" Screw (Line), M6 Screw (Load)                                   | 100 A       |
| 9 <sup>10</sup>                     | 1/4-20 "Bus-Type" Screw (Line), Box Wire Connector (Load)                     | 100 A       |
| J <sup>11</sup>                     | 1/4-20 "Bus-Type" Screw (Line), Box Wire Connector with Pressure Plate (Load) | 100 A       |

## 9 ACTUATOR COLOR & LEGEND <sup>13</sup>

| Actuator Color | I-O | ON-OFF | Dual | Legend Color |
|----------------|-----|--------|------|--------------|
| White          | A   | B      | 1    | Black        |
| Black          | C   | D      | 2    | White        |
| Red            | F   | G      | 3    | White        |
| Green          | H   | J      | 4    | White        |
| Blue           | K   | L      | 5    | White        |
| Yellow         | M   | N      | 6    | Black        |
| Gray           | P   | Q      | 7    | Black        |
| Orange         | R   | S      | 8    | Black        |

## 10. MOUNTING / BARRIERS

| BACK CONNECTED (FRONT MOUNTED ONLY)               |        |
|---|--------|
| Mounting Inserts                                  |        |
| A   | 6-32   |
| B   | ISO M3 |
| FRONT CONNECTED (BACK MOUNTED ONLY) <sup>14</sup> |        |
| Back Mounting Foot Type                           |        |
| C   | Short  |
| D   | Short  |
| E   | Long   |
| F   | Long   |
| Front Mounting Inserts (Optional Use)             |        |
|   | 6-32   |
|   | ISO M3 |
|   | 6-32   |
|   | ISO M3 |

## 11. MAXIMUM APPLICATION RATING <sup>15</sup>

|   |                                |   |                                   |
|---|--------------------------------|---|-----------------------------------|
| A | 65VDC, 120A                    | G | 600VAC, 100A <sup>16</sup>        |
| B | 125VDC, 120A                   | H | 480VAC, 100A <sup>16</sup>        |
| C | 120/240VAC, 100A               | J | 415VAC, 100A <sup>16</sup>        |
| D | 240VAC, 100A                   | L | 160VDC, 100A <sup>16</sup>        |
| E | 277/480VAC, 100A <sup>16</sup> | T | 125VDC/240VAC, 100A               |
| F | 277VAC, 100A                   | W | 125VDC/415VAC, 100A <sup>16</sup> |

## 12. AGENCY APPROVAL

|   |   |
|---|---|
| B | UL 1077 / UL 508 Recognized & CSA Accepted        |
| D | UL 1077 Recognized, CSA Accepted, & VDE Certified |

Notes:

- VDE approval on 1-5 poles only. Standard multi-pole units identical poles except when specifying auxiliary switch (Note 4). For mixed ratings, consult factory.
- Switch Only & Series Trip construction available with either front or back connected terminals. Shunt construction available with back connected terminals. (Terminal Codes 1 & 2) only. Circuit Codes B,C & D are VDE approved.
- Switch Only construction; 30 amps or less select Current Rating Code 630; 31-70 amps, select Current Rating code 670; 71-100 amps, select Current Rating Code 810; 101-125 amps Select Current Rating Code 912. Switch Only is VDE approved only if tied to a protected pole.
- Auxiliary Switch available on Switch Only and Series Trip units. On multi-pole units, only one auxiliary switch is normally supplied mounted in the extreme right pole. Back mounted units require special mounting provisions when auxiliary switch is specified. VDE approval on Auxiliary Switch Codes 0,2,3 & 4 only.
- Voltage trip coils are not rated for continuous duty. Available only with frequency & delay codes 10 & 20. Series trip construction with a voltage coil is VDE approved only if tied to a protected pole.
- Frequency & delay codes 92, 94 & 96 are not VDE Certified.
- Current Coil Ratings 0,100 - 100 amps are VDE Certified.
- 125 A rating (Code 912) available as a Switch Only (Circuit Code A), rated 125 VDC (Code B).
- An Anti-Flash Over Barrier is supplied between poles on multi-pole units with 10-32 (Terminal Code 1), 1/4-20 (Code 2), M5 (Code A), and M6 (Code B) terminals per UL requirement.
- Box Wire Connector will accept #14 through 0 AWG. copper wire or #12 through 0 AWG. aluminum wire.
- Box wire connector with pressure plate for stranded wire. Consult factory
- Terminal Codes A,B,D,E,G & H are not VDE Certified.
- VDE approvals require Dual (I-O, ON-OFF) or I-O markings on all handles.
- Back Mounted breakers can also be front mounted by utilizing the proper front panel mounting inserts normally supplied. However, terminal connections must be made prior to mounting.
- Application ratings B, D, J, T & W are available with VDE.
- 415, 480 & 600 VAC ratings require 3 or 4 pole break 30 and 2 pole break 10.



# Ordering Scheme

UL 489 Listed

Sample Part Number

**E A 2 - B 0 - 24 - 450 - 1 2 A - C C**

Selection 1 2 3 4 5 6 7 8 9 10 11 12

## 1. SERIES

E

## 2. ACTUATOR

A Handle, one per pole

## 3. POLES <sup>1</sup>

1 One 3 Three 5 Five  
2 Two 4 Four 6 Six

## 4. CIRCUIT <sup>2</sup>

B Series Trip (current) C Series Trip (voltage) <sup>3</sup>

## 5 AUXILIARY SWITCH <sup>4</sup>

0 without Auxiliary Switch 6 S.P.S.T. 0.110 Q.C. Terminals  
2 S.P.D.T. 0.110 Q.C. Terminals 7 S.P.S.T. 0.110 Q.C. Terminals  
3 S.P.D.T. 0.139 Solder Lug (Gold Contacts)  
4 S.P.D.T. 0.110 Q.C. Terminals (Gold Contacts) 8 S.P.S.T. 0.187 Q.C. Terminals  
9 S.P.D.T. 0.187 Q.C. Terminals

## 6. FREQUENCY & DELAY

10 DC Instantaneous <sup>5</sup> 24 50/60Hz Medium  
12 DC Short 26 50/60Hz Long  
14 DC Medium 62 50/60Hz Short, High-inrush  
16 DC Long 64 50/60Hz Medium, High-inrush  
20 50/60Hz Instantaneous <sup>5</sup> 66 50/60Hz Long, High-inrush  
22 50/60Hz Short 74 DC, Medium, High-inrush  
76 DC, Long, High-inrush

## 7. CURRENT RATING (AMPERES) <sup>7</sup>

| CODE | AMPERES |     |       |     |        |     |                      |
|------|---------|-----|-------|-----|--------|-----|----------------------|
| 020  | 0.020   | 235 | 0.350 | 430 | 3.000  | 614 | 14.000               |
| 025  | 0.025   | 240 | 0.400 | 435 | 3.500  | 615 | 15.000               |
| 030  | 0.030   | 245 | 0.450 | 440 | 4.000  | 616 | 16.000               |
| 035  | 0.035   | 250 | 0.500 | 445 | 4.500  | 617 | 17.000               |
| 040  | 0.040   | 255 | 0.550 | 450 | 5.000  | 618 | 18.000               |
| 045  | 0.045   | 260 | 0.600 | 455 | 5.500  | 620 | 20.000               |
| 050  | 0.050   | 265 | 0.650 | 460 | 6.000  | 622 | 22.000               |
| 055  | 0.055   | 270 | 0.700 | 465 | 6.500  | 624 | 24.000               |
| 060  | 0.060   | 275 | 0.750 | 470 | 7.000  | 625 | 25.000               |
| 065  | 0.065   | 280 | 0.800 | 475 | 7.500  | 630 | 30.000               |
| 070  | 0.070   | 285 | 0.850 | 480 | 8.000  | 635 | 35.000               |
| 075  | 0.075   | 290 | 0.900 | 485 | 8.500  | 640 | 40.000               |
| 080  | 0.080   | 295 | 0.950 | 490 | 9.000  | 650 | 50.000               |
| 085  | 0.085   | 410 | 1.000 | 495 | 9.500  | 660 | 60.000               |
| 090  | 0.090   | 512 | 1.250 | 610 | 10.000 | 670 | 70.000               |
| 090  | 0.095   | 415 | 1.500 | 710 | 10.500 | 680 | 80.000               |
| 210  | 0.100   | 517 | 1.750 | 611 | 11.000 | 690 | 90.000               |
| 215  | 0.150   | 420 | 2.000 | 711 | 11.500 | 810 | 100.000              |
| 220  | 0.200   | 522 | 2.250 | 612 | 12.000 | 811 | 110.000              |
| 225  | 0.250   | 425 | 2.500 | 712 | 12.500 | 812 | 120.000              |
| 230  | 0.300   | 527 | 2.750 | 613 | 13.000 | 912 | 125.000 <sup>8</sup> |

## OR VOLTAGE COIL <sup>5</sup>

| CODE | RATING | TRIP VOLTS |     |       |       |     |       |       |
|------|--------|------------|-----|-------|-------|-----|-------|-------|
| A06  | 6DC    | 5DC        | A65 | 65DC  | 55DC  | J48 | 48AC  | 40AC  |
| A12  | 12DC   | 10DC       | B25 | 120DC | 100DC | J65 | 65AC  | 55AC  |
| A18  | 18DC   | 15DC       | J06 | 6AC   | 5AC   | K20 | 120AC | 65AC  |
| A24  | 24DC   | 20DC       | J12 | 12AC  | 10AC  | L40 | 240AC | 130AC |
| A32  | 32DC   | 25DC       | J18 | 18AC  | 15AC  |     |       |       |
| A48  | 48DC   | 40DC       | J24 | 24AC  | 20AC  |     |       |       |

## 8. TERMINAL <sup>7</sup>

|                 | BACK CONNECTED (FRONT MOUNTED ONLY)   | MAX. RATING |
|-----------------|---|-------------|
| 1 <sup>8</sup>  | 10-32 Stud (All Terminals)  | 50 A        |
| 2 <sup>8</sup>  | 1/4-20 Stud (All Terminals)   | 125 A       |
|                 | FRONT CONNECTED (BACK MOUNTED ONLY)   |             |
| 3 <sup>9</sup>  | Box Wire Connector (Line & Load)  | 100 A       |
| C <sup>10</sup> | Box Wire Connector with Pressure Plate (Line & Load)                          | 100 A       |
| 4               | 10-32 Screw (Line & Load)   | 50 A        |
| 5               | 10-32 "Bus-Type" Screw (Line), 10-32 Screw (Load)                             | 50 A        |
| 6 <sup>9</sup>  | 10-32 "Bus-Type" Screw (Line), Box Wire Connector (Load)                      | 100 A       |
| F <sup>10</sup> | 10-32 "Bus-Type" Screw (Line), Box Wire Connector with Pressure Plate (Load)  | 100 A       |
| 7               | 1/4-20 Screw (Line & Load)  | 100 A       |
| 8               | 1/4-20 "Bus-Type" Screw (Line), 1/4-20 Screw (Load)                           | 100 A       |
| 9 <sup>9</sup>  | 1/4-20 "Bus-Type" Screw (Line), Box Wire Connector (Load)                     | 100 A       |
| J <sup>10</sup> | 1/4-20 "Bus-Type" Screw (Line), Box Wire Connector with Pressure Plate (Load) | 100 A       |

## 9 ACTUATOR COLOR & LEGEND <sup>12</sup>

| Actuator Color | ON-OFF | Dual | Legend Color |
|----------------|--------|------|--------------|
| White          | B      | 1    | Black        |
| Black          | D      | 2    | White        |
| Red            | G      | 3    | White        |
| Green          | J      | 4    | White        |
| Blue           | L      | 5    | White        |
| Yellow         | N      | 6    | Black        |
| Gray           | Q      | 7    | Black        |
| Orange         | S      | 8    | Black        |

## 10. MOUNTING / BARRIERS

|   | BACK CONNECTED (FRONT MOUNTED ONLY)               |  |
|---|---|--|
|   | <b>Mounting Inserts</b>                           |  |
| A | 6-32  |  |
| B | ISO M3  |  |
|   | FRONT CONNECTED (BACK MOUNTED ONLY) <sup>11</sup> |  |
|   | <b>Back Mounting Foot Type</b>                    | <b>Front Mounting Inserts (Optional Use)</b> |
| C | Short   | 6-32   |
| D | Short   | ISO M3                                       |
| E | Long  | 6-32   |
| F | Long  | ISO M3                                       |

## 11. MAXIMUM APPLICATION RATING

|   |         |   |                                 |
|---|---------|---|---------------------------------|
| 1 | 120 VAC | C | 120/240 VAC, 100A <sup>13</sup> |
| B | 125 VDC | D | 240 VAC, 100A                   |

## 12. AGENCY APPROVAL

|   |   |
|---|---|
| C | UL 489 Listed & CSA Certified                 |
| F | UL 489 Listed, CSA Certified, & VDE Certified |

### Notes:

- Standard multi-pole units identical poles except when specifying auxiliary switch (Note 4). For mixed ratings, consult factory. VDE Certification on 1-5 poles only.
- Series Trip construction available with either front or back connected terminals.
- Series Trip construction with a voltage coil is not available as a single pole unit and must be tied to a protected pole.
- On multi-pole units, only one auxiliary switch is normally supplied mounted in the extreme right pole per Figure A. Back mounted units require special mounting provisions when auxiliary switch is specified. VDE Certification on auxiliary switch codes 0, 2, 3 & 4 only.
- Voltage Trip Coils are not rated for continuous duty. Available only with Frequency & Delay Codes 10 & 20.
- Frequency & Delay Codes 92, 94 & 96 are not VDE Certified.
- Current Ratings under 0.100 amps are not VDE Certified.
- An Anti-Flash Over Barrier is supplied between poles on multi-pole units with 10-32 Stud (Terminal Code 1) or 1/4-20 Stud (Code 2) terminals per UL requirement.
- Box Wire Connector will accept #14 through 0 AWG. copper wire or #12 through 0 AWG. aluminum wire.
- Box Wire Connector with Pressure Plate for stranded wire. Consult factory.
- Back Mounted breakers can also be front mounted by utilizing the proper front panel mounting inserts normally supplied. However, terminal connections must be made prior to mounting.
- VDE Certification requires dual (I-O, ON-OFF) markings on all handles.
- Not available with VDE Certification.

[Configure Complete Part Number >](#)

[Browse Standard Parts >](#)

# Dimensional Specs

inches [millimeters]

## MOUNTING INSERTS:

#6-32[M3]THREADX.220[5.59]  
MIN. DEEP (2 PLCS)/POLE

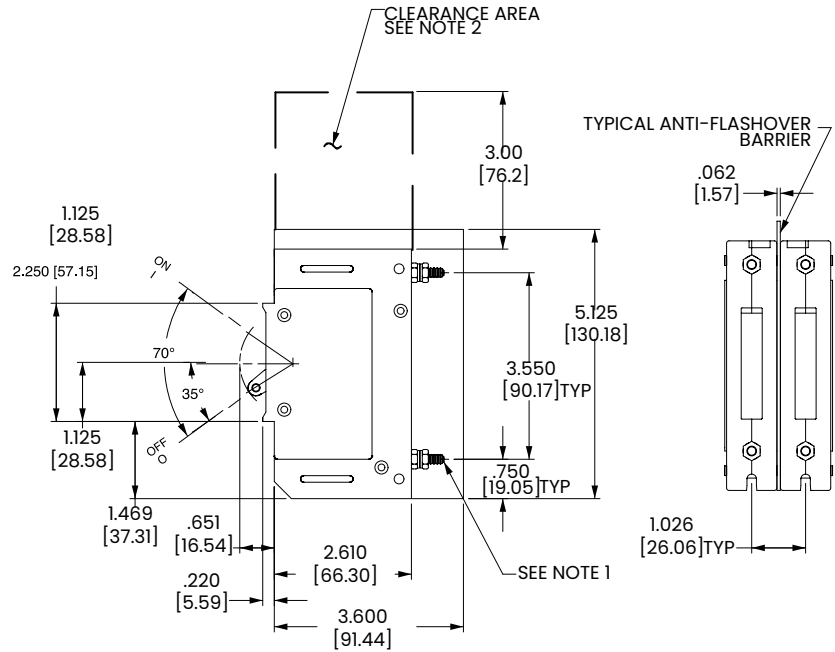
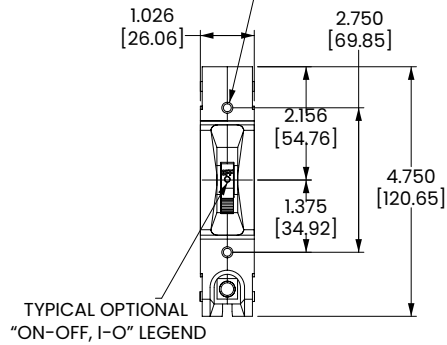

## PANEL CUTOUT DETAIL

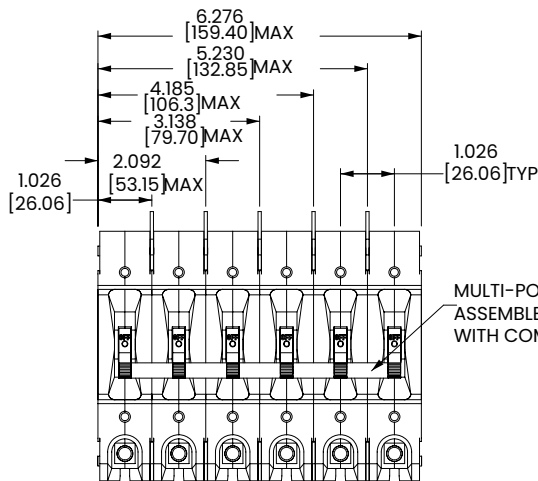

MULTI-POLE UNITS ARE  
ASSEMBLED AT FACTORY  
WITH COMMON HANDLE TIE

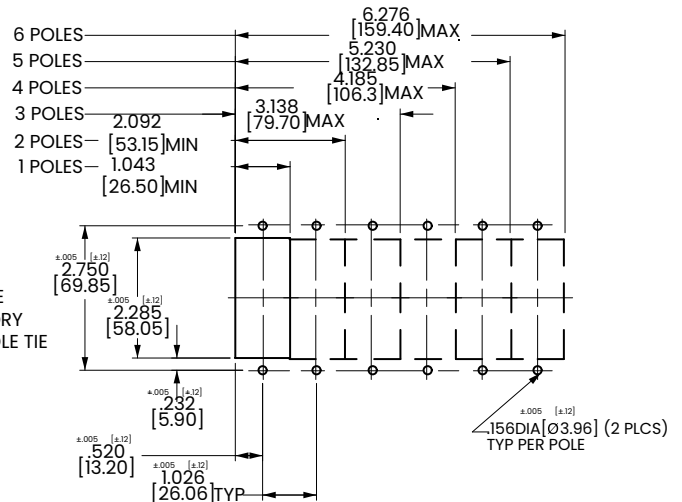

### Notes:

- 1 1/4 -20 stud terminal in Series Trip circuit configuration shown.
- 2 A 3" min spacing must be provided between the circuit breaker arc venting area of back connected E-Series circuit breaker and grounded obstructions.
- 3 Tolerance  $\pm 0.020$  [.51] unless otherwise specified.
- 4 Circuit breakers must be mounted on vertical surface.

# Dimensional Specs

inches [millimeters]

## MOUNTING INSERTS:

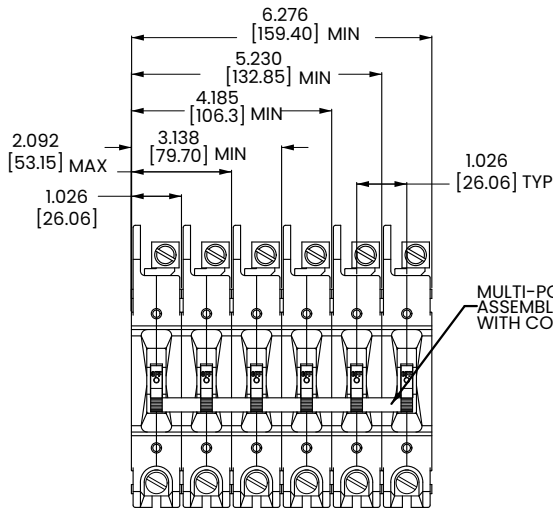
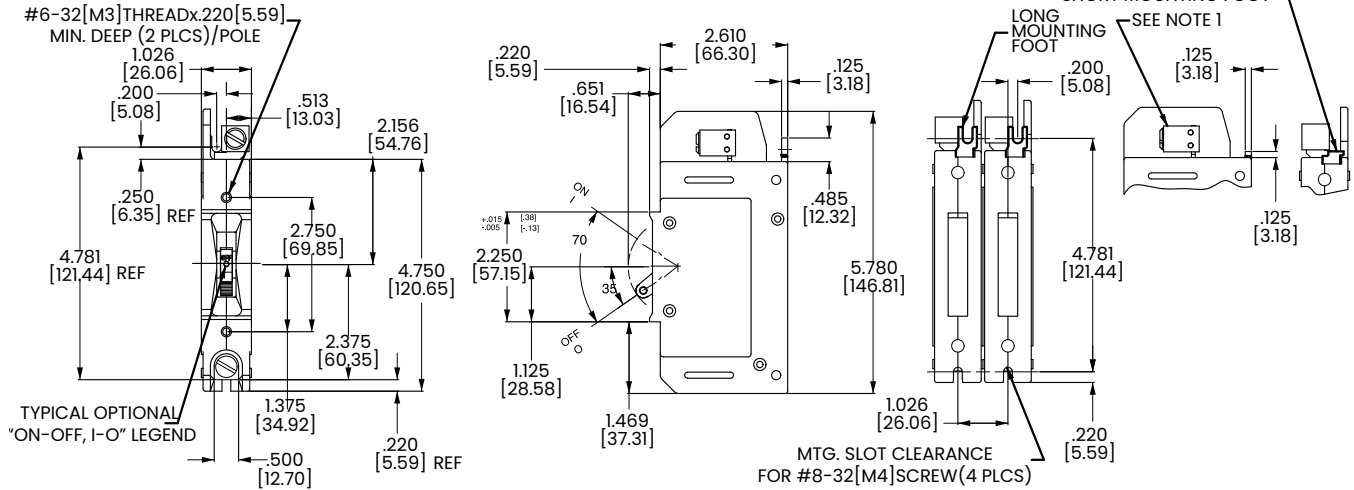

## PANEL CUTOUT DETAIL

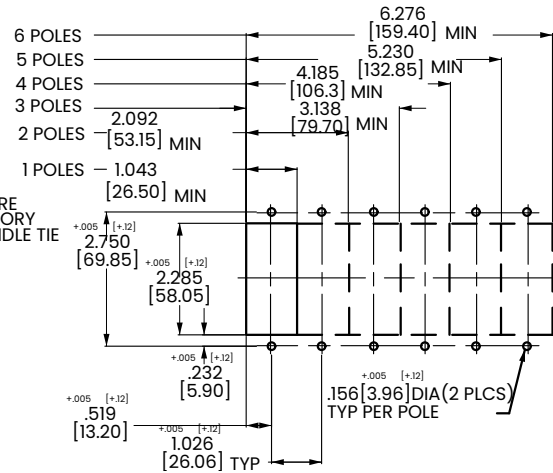

- Notes:
- 1 Tolerance  $\pm 0.020$  [.51] unless otherwise specified.
  - 2 Box wire connector terminal in Series Trip circuit configuration shown.
  - 3 Circuit breakers must be mounted on vertical surface.



# Circuit & Terminal Diagram

inches [millimeters]

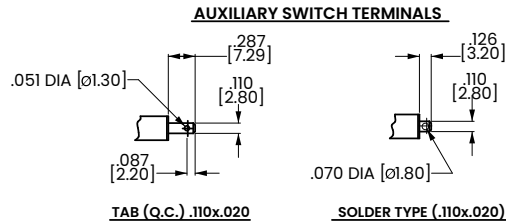
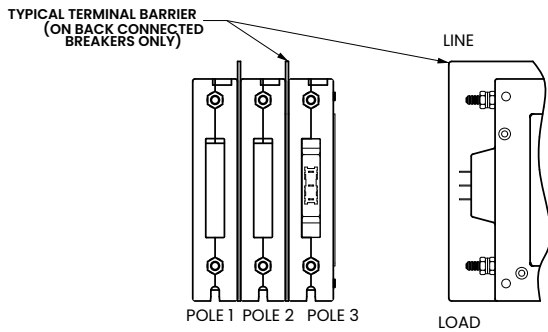
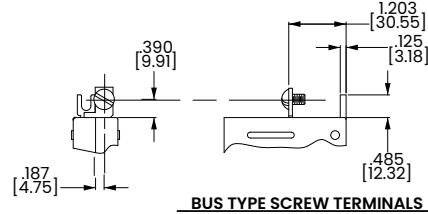
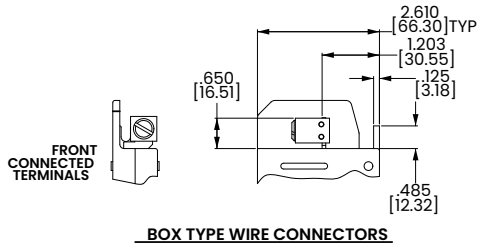
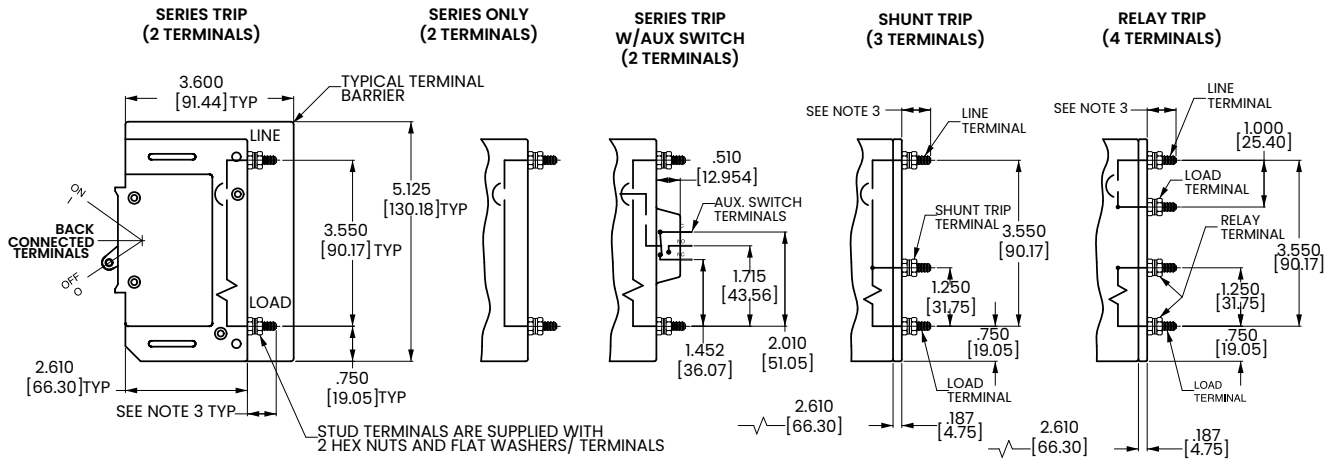

| TABLE A<br>TIGHTENING TORQUE SPECIFICATIONS |           |                           |
|---|-----------|---------------------------|
| THREAD SIZE TERMINAL TYPE                   | WIRE SIZE | TORQUE                    |
| #6-32 [M3] HARDWARE                         | —         | 7-9 IN-LBS [0.8-1.0 NM]   |
| #10-32 THD TERMINAL SCREW                   | ALL       | 15-20 IN-LBS [1.7-2.3 NM] |
| 1/4-20 THD TERMINAL SCREW                   | ALL       | 30-35 IN-LBS [3.4-4.0 NM] |
| #10-32 STUD                                 | ALL       | 15-20 IN-LBS [1.7-2.3 NM] |
| 1/4-20 STUD                                 | ALL       | 30-35 IN-LBS [3.4-4.0 NM] |
| BOX WIRE CONNECTOR                          | 14-10 AWG | 35 IN-LBS [4.0 NM]        |
|   | 8 AWG     | 40 IN-LBS [4.5 NM]        |
|   | 6-4 AWG   | 45 IN-LBS [5.1 NM]        |
|   | 3-1/0 AWG | 50 IN-LBS [5.7 NM]        |

**Notes:**

- 1 Tolerance  $\pm .020$  [.51] unless otherwise specified.
- 2 0-50 amps: 10-32 & M5 Studs .625 $\pm$ .062/15.88 $\pm$ 1.574 long.
- 3 51-120 amps: 1/4-20 & M6 Studs .750 $\pm$ .062/19.05 $\pm$ 1.574 long.

# Time Delay

| E-SERIES TIME DELAY VALUES |                          |             |             |      |             |             |             |             |              |             |             |
|----------------------------|--------------------------|-------------|-------------|------|-------------|-------------|-------------|-------------|--------------|-------------|-------------|
| TRIP TIME (SECONDS)        | PERCENT OF RATED CURRENT |             |             |      |             |             |             |             |              |             |             |
|                            | Delay                    | 100%        | 125%        | 135% | 150%        | 200%        | 400%        | 600%        | 800%         | 1000%       | 1200%       |
| 10                         | No Trip                  | May Trip    | ---         | ---  | .001 - .038 | .001 - .032 | .001 - .021 | .001 - .019 | .001 - .019  | .001 - .019 | .001 - .019 |
| 12, 72                     | No Trip                  | .600 - 7.00 | ---         | ---  | .330 - 2.00 | .150 - .800 | .033 - .160 | .016 - .071 | .010 - .048  | .008 - .040 | .008 - .040 |
| 14, 74                     | No Trip                  | 11.0 - 110  | ---         | ---  | 6.00 - 45.0 | 3.00 - 18.0 | .280 - 3.50 | .013 - 1.50 | .010 - .130  | .009 - .090 | .009 - .080 |
| 16, 76                     | No Trip                  | 100 - 800   | ---         | ---  | 50.0 - 360  | 20.0 - 120  | 3.00 - 25.0 | .020 - 11.0 | .010 - .700  | .009 - .230 | .009 - .200 |
| 20                         | No Trip                  | May Trip    | ---         | ---  | .001 - .040 | .001 - .031 | .001 - .020 | .001 - .020 | .001 - .020  | .001 - .020 | .001 - .020 |
| 22, 62                     | No Trip                  | .800 - 5.00 | ---         | ---  | .400 - 2.30 | .150 - .900 | .034 - .170 | .020 - .080 | .012 - .051  | .010 - .040 | .009 - .040 |
| 24, 64                     | No Trip                  | 7.20 - 90.0 | ---         | ---  | 4.40 - 35.0 | 2.00 - 15.0 | .500 - 3.50 | .025 - 1.60 | .012 - .330  | .010 - .070 | .009 - .050 |
| 26, 66                     | No Trip                  | 50.0 - 500  | ---         | ---  | 32.0 - 250  | 14.0 - 120  | 2.50 - 24.0 | .320 - 7.00 | .0125 - 3.10 | .011 - .130 | .010 - .055 |
| 30                         | No Trip                  | May Trip    | ---         | ---  | .001 - .040 | .001 - .032 | .001 - .020 | .001 - .020 | .001 - .020  | .001 - .020 | .001 - .020 |
| 32, 92                     | No Trip                  | May Trip    | .450 - 5.20 | ---  | .330 - 2.30 | .150 - .900 | .033 - .170 | .016 - .080 | .009 - .051  | .008 - .040 | .008 - .040 |
| 34, 94                     | No Trip                  | May Trip    | 5.80 - 73.0 | ---  | 4.40 - 45.0 | 2.00 - 18.0 | .280 - 3.60 | .013 - 1.60 | .010 - .330  | .009 - .090 | .009 - .080 |
| 36, 96                     | No Trip                  | May Trip    | 42.0 - 600  | ---  | 32.0 - 360  | 14.0 - 120  | 2.50 - 25.0 | .020 - 11.0 | .010 - 4.10  | .009 - .330 | .009 - .200 |

**NOTES**

Delay Curves 10,20,30: Breakers to hold 100% and must trip at 150% of rated current and greater within the time limit shown in these curves.  
 Delay Curves 12,14,16,22,24,26,62,64,66,72,74,76: Breakers to hold 100% and must trip at 125% of rated current and greater within the time limit shown in these curves.  
 Delay Curves 32,34,36,92,94,96: Breakers to hold 100% and must trip at 135% of rated current and greater within the time limit shown in these curves. All curves: Data shown represents breaker response at ambient temperature of 77°F (25°C) with no preloading; Breakers are mounted in standard wall-mount position. The minimum inrush pulse tolerance handling capacity on the above standard delays is 16 times rated current & 20 times rated current for high inrush delays based on a 60Hz 1/2 cycle, 8.33 ms pulse.

**Instantaneous**

**AC**

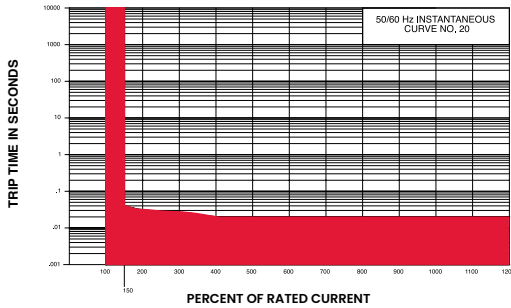

**DC**

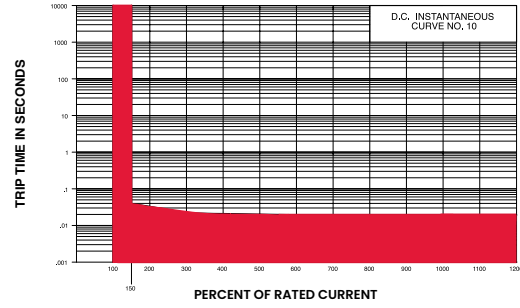

**Short**

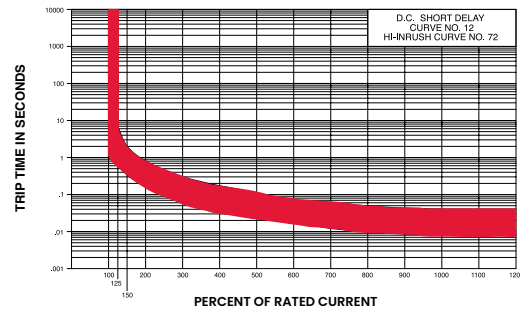
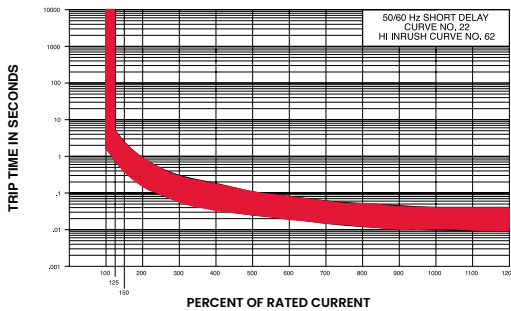

**Medium**

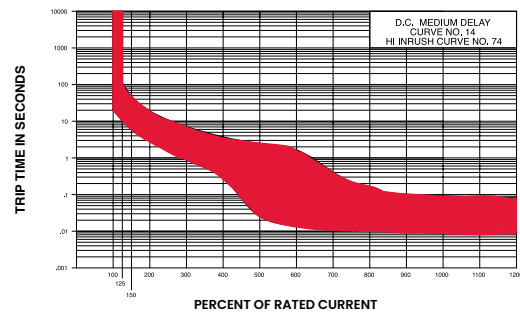
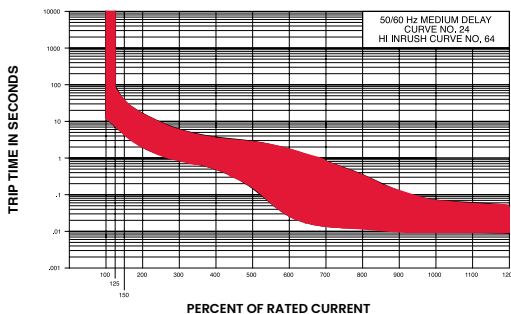

**Long**

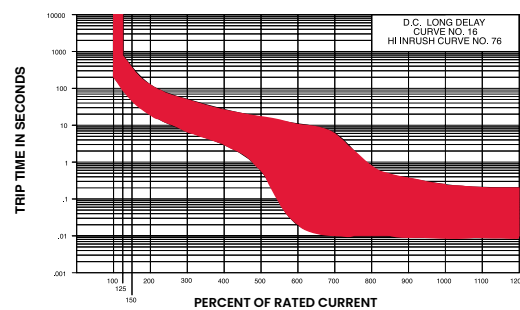
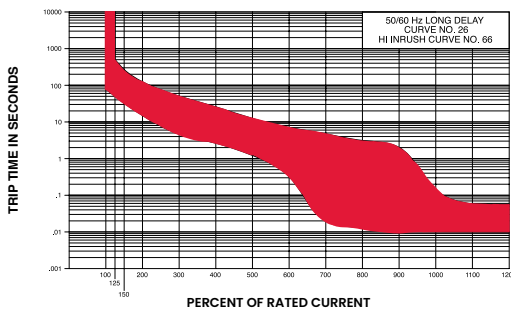

# Time Delay

## AC/DC

### Instantaneous

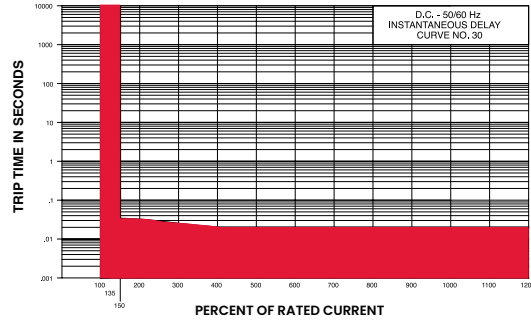

### Short

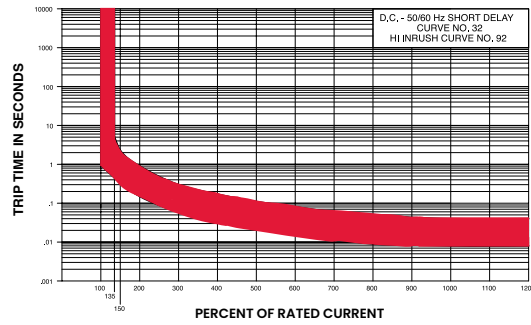

### Medium

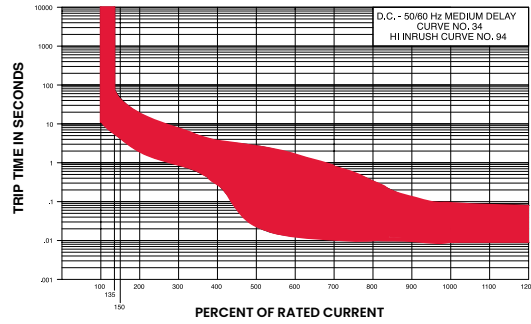

### Long

