

E-Series

Hydraulic-Magnetic Circuit Breaker

PRODUCT WEBPAGE

request sample, configure part

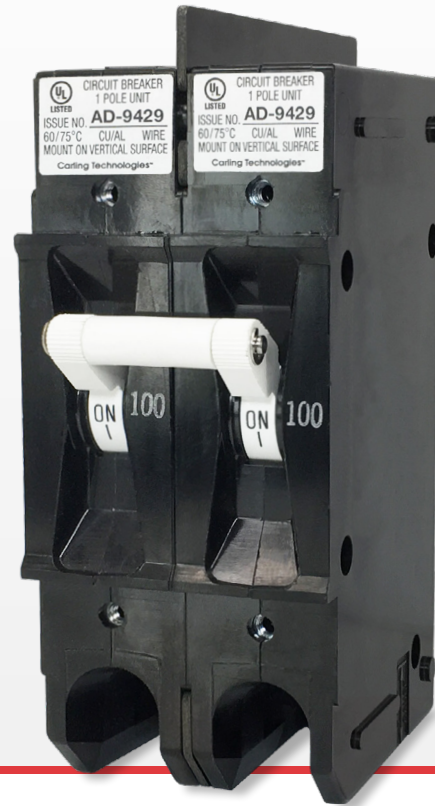

High Current and Voltage Breaker Qualified Supplementary Protector

The E-Series hydraulic-magnetic circuit breaker is designed for higher current and voltage applications and qualified, as per agency approval, for branch circuit protection or as a supplementary protector. E-Series breakers are available as a one to six pole configuration and are rated up to 125 amps and 600VAC or 125VDC, with a max IC of 10,000 amps.

1-6 Poles **1-100** Amps **600** VAC Max **125** VDC Max

Typical Applications

- Renewable Energy
- Industrial Automation
- High Voltage/Current Applications
- Military
- Generators
- Commercial Food

Tech Specs

Electrical

Maximum Voltage	600VAC 50/60 Hz, 125VDC (See Table A)
Current Ratings	Standard current coils: 0.100, 0.250, 0.500, 1.00, 2.50, 5.00, 7.50, 10.0, 15.0, 20.0, 25.0, 30.0, 50.0, 60.0, 70.0 & 100 Amp.
Auxiliary Switch Rating	SPDT; 10.1A 250VAC, 1.0A 65VDC; 0.5A 80VDC, 0.1A 125VAC (with gold contacts).
Insulation Resistance	Minimum of 100 Megohms at 500 VDC.
Dielectric Strength	UL, CSA: 2200 V 50/60 Hz for one minute between all electrically isolated terminals. E-Series Circuit Breakers comply with the 8mm spacing and 3750V 50/60 Hz dielectric requirements from hazardous voltage to operator accessible surfaces, between adjacent poles and from main circuits to auxiliary circuits per Publications EN 60950 and VDE 0805.
Resistance, Impedance	Values from Line to Load Terminal - based on Series Trip Circuit Breaker

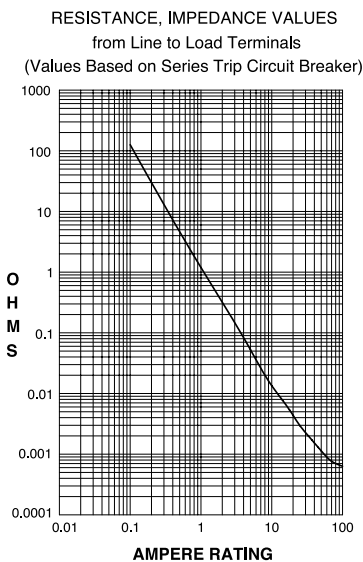

Pulse Tolerance Curves

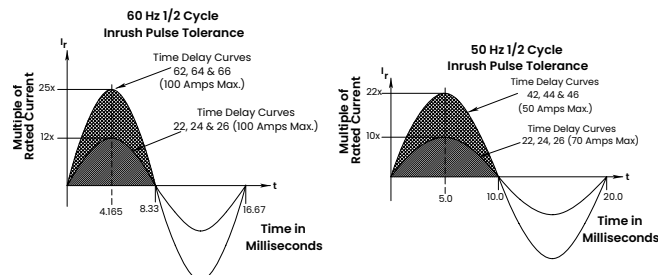

Mechanical

Endurance	10,000 ON-OFF operations @ 6 per minute; with rated current & voltage.
Trip Free	All E-Series circuit breakers will trip on overload, even when Handle is forcibly held in the ON position.
Trip Indication	The operating Handle moves positively to the OFF position when an overload causes the breaker to trip.

Physical

Number of Poles	1-6
Mounting	A 3" minimum spacing must be provided between the circuit breaker arc venting area on back connected E-Series circuit breakers and grounded obstructions. E-Series circuit breakers must be mounted on a vertical surface.
Connectors, Box Type	Front connected E-Series circuit breakers are supplied with box type pressure connectors that accept copper or aluminum conductors as follows: 1/0-14 Copper, 1/0-12 Aluminum.
Internal Circuit Configuration	Series and Switch Only, (with or Configuration without auxiliary switch). Shunt with current coils.
Weight	Approximately 252 grams/pole (Approximately 9 ounces/pole)
Standard Colors	Housing-Black; Actuator - See Ordering Scheme.

Environmental

Designed in accordance with requirements of specification MIL PRF-55629 & MIL-STD-202G as follows:

Shock	Withstands 100 Gs, 6ms, sawtooth while carrying rated current per Method 213, Test Condition "I".
Vibration	Withstands 0.060" excursion from 10-55 Hz, and 10 Gs 55-500 Hz, at rated current per Method 204C, Test Condition A.
Moisture Resistance	Method 106D, i.e., ten 24-hour cycles @ + 25°C to +65°C, 80-98% RH.
Salt Spray	Method 101, Condition A (90-95% RH @ 5% NaCl Solution, 96 hrs).
Thermal Shock	Method 107D, Condition A (Five cycles @ -55°C to +25°C to +85°C to +25°C).
Operating Temperature	-40° C to +85° C

Tech Specs

Tables

Table A: Lists UL Listed (489) & CSA Certified (C22.2 No. 5) configurations & performance capabilities as a Molded Case Circuit Breaker.

UL489 Listed Branch Circuit Breakers						
Circuit Configuration	Voltage			Current Rating	Interrupting Capacity (Amps)	High Interrupting Capacity (Amps)
	Max Rating	Frequency	Phase	Full Load Amps	Without Backup Fuse	
Series	80	DC	-	0.10 - 100	5,000	50,000
	125		-			10,000
	120		-	-		
	240	50/60	1	0.10 - 125	5,000	-
	120 / 240			0.10 - 30		10,000
				31 - 100		-
				0.10 - 30		10,000
				31 - 100		-
	240			3		101 - 125
	240	0.10 - 100	5,000		-	

Table B: Lists UL Recognized & CSA Accepted configurations & performance capabilities as a Component Supplementary Protector.

Component Supplementary Protectors											
Circuit Configuration	Voltage			Current Rating		Short Circuit Capacity (Amps)		Application Codes			
	Max Rating	Frequency	Phase	Full Load Amps	General Purpose Amps	UL/CSA		UL	CSA		
						With Backup Fuse	Without Backup Fuse				
Series & Shunt	125	DC	-	0.02 - 100	-	-	5,000	TC1,2, OLI, UI	TC1,2, OLI, UI		
	125			-	101 - 120			TC1,2, OL0, UI	TC1,2, OL0, UI		
	150			0.02 - 125	TC1, OL0, U3			TC1, OL0, U3			
	160			-	TC1,2, OLI, UI			TC1,2, OLI, UI			
	150 / 300			-	TC1,2, OLI, UI			TC1,2, OLI, UI			
	120 / 240	50/60	1	-	0.02 - 100	-	10,000	TC1,2, OLI, UI	TC1,2, OLI, UI		
	240			TC1,2, OL0, UI	TC1,2, OL0, UI						
	250			TC1,2, OLI, UI	TC1,2, OLI, UI						
	277			0.02 - 100	-			5,000	TC1,2, OLI, C1	TC1,2, OLI, C1	
	480			1 & 3	0.02 - 50			-	10,000	TC1,2, OLI, UI	TC1,2, OLI, UI
	480 ¹									TC1,2, OLI, C1	TC1,2, OLI, C1
	600									TC1,2, OLI, C1	TC1,2, OLI, C1
	600 ²									TC1,2, OLI, C1	TC1,2, OLI, C1
600	-	0.02 - 125	-	5,000	TC1, OL0, U3	TC1, OL0, U3					
Switch Only	125	DC	-	0.02 - 120							
	160	50/60	1								
	240										
	277										
	480										
	600									1 & 3	

Notes:

- 1 Per pole opposite polarity rating - Delta Configuration.
- 2 4 Poles connected in series
- 3 Requires branch circuit backup with a UL Listed Type K5 or RK5 fuse rated 15A minimum and no more than 4 times full load amp rating and not to exceed 225A.

Tech Specs

Table C: Lists UL Recognized, CSA Accepted and VDE Certified configurations and performance capabilities as a Component Supplementary Protector.

Component Supplementary Protectors With VDE										
Circuit Configuration	Voltage			Current Rating Full Load Amps	Short Circuit Capacity (Amps)			Application Codes		Construction Notes
	Max Rating	Frequency	Phase		UL/CSA		VDE (Icn)	UL	CSA	
				With Backup Fuse	Without Backup Fuse	Without Backup Fuse				
Series & Shunt	125	DC	-	0.1 - 100	-	5,000	5,000	TC1,2, OLI, UI	TC1,2, OLI, UI	1 or 2 Poles
	240	50/60	1 & 3		10,000	-	4,000	TC1,2, OLI, CI	TC1,2, OLI, CI	1-5 poles. Up to 4 Current Poles, 1 Voltage Pole
	415				TC1,2, OLI, CI	TC1,2, OLI, CI	2-5 poles. Up to 4 Current Poles, 1 Voltage Pole			
Switch Only	125	DC	-	0.1 - 125						
	240	50/60	1 & 3	0.1 - 100						
	415									

Notes:
 1 Requires branch circuit backup with a UL LISTED Type K5 or RK5 fuse rated 15A minimum and no more than 4 times full load amp rating and not to exceed 225 amps.

Table D: Lists UL Recognized, CSA Accepted configurations and performance capabilities as Protectors, Supplementary for Marine Electrical and Fuel Systems (Guide PEQZ2, File E75596). Ignition Protected per UL 1500. UL Classified Small Craft Electrical Devices, Marine in accordance with ISO 8846 (Guide UZMK, File MQ1515) as Marine Supplementary Protectors.

UL1500 (Marine Ignition Protection)							
Circuit Configuration	Voltage			Current Rating Full Load Amps	Short Circuit Capacity (Amps) With Backup Fuse	Application Codes	
	Max Rating	Frequency	Phase			UL	CSA
Series	65	DC	-	0.2 - 100	5,000	TC1,2, OLI, UI	TC1,2, OLI, UI
	125	50/60	1		1,500		
	250						

Agency Approvals

UL 1077	Component Recognition Program as Protectors, Supplementary (Guide QVNU2, File E75596)
UL 1500	Component Recognition Program as Manual Motor Controls (Guide NLRV2, File E135367)
UL 489	Protectors, Supplementary for Marine Electrical & Fuel Systems (Guide PEQZ2, File E75596) Ignition Protection
CSA Accepted	Component Supplementary Protector (Class 3215 30, File 047848 0 000) CSA Standard C22.2 No. 235
CSA Certified	Circuit Breaker Molded Case (Class 1432 01, File 093910), CSA Standard C22.2 No. 5.1 - M
TUV Certified	EN60934 under License No. R72031056
VDE Certified	EN60934, VDE 0642 under File No. 10537

Time Delay Specs

To view all hydraulic-magnetic circuit breaker time delay values, please visit www.carlingtech.com/sites/default/files/documents/Carling-HM-CB-Time-Delays.pdf

Ordering Scheme

UL 1077 Recognized

Sample Part Number

E A 2 - B 0 - 24 - 450 - 1 2 A - C B

Selection 1 2 3 4 5 6 7 8 9 10 11 12

1. SERIES

E

2. ACTUATOR

A Handle, one per pole

3. POLES ¹

1 One	3 Three	5 Five
2 Two	4 Four	6 Six

4. CIRCUIT ²

A Switch Only (no coil) ³	E Shunt Trip (voltage)
B Series Trip (current)	F Relay Trip (current)
C Series Trip (voltage)	G Relay Trip (voltage)
D Shunt Trip (current)	

5 AUXILIARY SWITCH ⁴

0 without Auxiliary Switch	6 S.P.S.T. 0.110 Q.C. Terminals
2 S.P.D.T. 0.110 Q.C. Terminals	7 S.P.S.T. 0.110 Q.C. Terminals (Gold Contacts)
3 S.P.D.T. 0.139 Solder Lug	8 S.P.S.T. 0.187 Q.C. Terminals
4 S.P.D.T. 0.110 Q.C. Terminals (Gold Contacts)	9 S.P.D.T. 0.187 Q.C. Terminals

6. FREQUENCY & DELAY

03 DC 50/60Hz, Switch Only ³	36 DC, 50/60Hz Long
10 DC Instantaneous ⁵	62 50/60Hz Short, High-inrush
12 DC Short	64 50/60Hz Medium, High-inrush
14 DC Medium	66 50/60Hz Long, High-inrush
16 DC Long	74 DC, Medium, High-inrush
20 50/60Hz Instantaneous ⁵	76 DC, Long, High-inrush
22 50/60Hz Short	92 DC, 50/60Hz Short, High-inrush ⁶
24 50/60Hz Medium	94 DC, 50/60Hz Medium, High-inrush ⁶
26 50/60Hz Long	96 DC, 50/60Hz Long, High-inrush ⁶
30 DC, 50/60Hz Instantaneous	
32 DC, 50/60Hz Short	
34 DC, 50/60Hz Medium	

7. CURRENT RATING (AMPERES) ⁴

CODE	AMPERES						
020	0.020	235	0.350	430	3.000	614	14.000
025	0.025	240	0.400	435	3.500	615	15.000
030	0.030	245	0.450	440	4.000	616	16.000
035	0.035	250	0.500	445	4.500	617	17.000
040	0.040	255	0.550	450	5.000	618	18.000
045	0.045	260	0.600	455	5.500	620	20.000
050	0.050	265	0.650	460	6.000	622	22.000
055	0.055	270	0.700	465	6.500	624	24.000
060	0.060	275	0.750	470	7.000	625	25.000
065	0.065	280	0.800	475	7.500	630	30.000
070	0.070	285	0.850	480	8.000	635	35.000
075	0.075	290	0.900	485	8.500	640	40.000
080	0.080	295	0.950	490	9.000	650	50.000
085	0.085	410	1.000	495	9.500	660	60.000
090	0.090	512	1.250	610	10.000	670	70.000
090	0.095	415	1.500	710	10.500	680	80.000
210	0.100	517	1.750	611	11.000	690	90.000
215	0.150	420	2.000	711	11.500	810	100.000
220	0.200	522	2.250	612	12.000	811	110.000
225	0.250	425	2.500	712	12.500	812	120.000
230	0.300	527	2.750	613	13.000	912	125.000 ⁸

OR VOLTAGE COIL ⁵

CODE	RATING	TRIP VOLTS						
A06	6DC	5DC	A65	65DC	55DC	J48	48AC	40AC
A12	12DC	10DC	B25	120DC	100DC	J65	65AC	55AC
A18	18DC	15DC	J06	6AC	5AC	K20	120AC	65AC
A24	24DC	20DC	J12	12AC	10AC	L40	240AC	130AC
A32	32DC	25DC	J18	18AC	15AC			
A48	48DC	40DC	J24	24AC	20AC			

Configure Complete Part Number >

Browse Standard Parts >

8. TERMINAL ¹²

	BACK CONNECTED (FRONT MOUNTED ONLY)	MAX. RATING
1 ⁹	10-32 Stud (All Terminals)	50 A
2 ⁹	1/4-20 Stud (All Terminals)	120 A
A ⁹	M5 Stud (Line & Load)	50 A
B ⁹	M6 Stud (Line & Load)	100 A
FRONT CONNECTED (BACK MOUNTED ONLY)		
3 ¹⁰	Box Wire Connector (Line & Load)	100 A
C ¹¹	Box Wire Connector with Pressure Plate (Line & Load)	100 A
4	10-32 Screw (Line & Load)	50 A
D	M5 Screw (Line & Load)	50 A
5	10-32 "Bus-Type" Screw (Line), 10-32 Screw (Load)	50 A
E	M5 "Bus-Type" Screw (Line), 10-32 Screw (Load)	50 A
6 ¹⁰	10-32 "Bus-Type" Screw (Line), Box Wire Connector (Load)	100 A
F ¹¹	10-32 "Bus-Type" Screw (Line), Box Wire Connector with Pressure Plate (Load)	100 A
7	1/4-20 Screw (Line & Load)	100 A
G	M6 Screw (Line & Load)	100 A
8	1/4-20 "Bus-Type" Screw (Line), 1/4-20 Screw (Load)	100 A
H	M6 "Bus-Type" Screw (Line), M6 Screw (Load)	100 A
9 ¹⁰	1/4-20 "Bus-Type" Screw (Line), Box Wire Connector (Load)	100 A
J ¹¹	1/4-20 "Bus-Type" Screw (Line), Box Wire Connector with Pressure Plate (Load)	100 A

9 ACTUATOR COLOR & LEGEND ¹³

Actuator Color	I-O	ON-OFF	Dual	Legend Color
White	A	B	1	Black
Black	C	D	2	White
Red	F	G	3	White
Green	H	J	4	White
Blue	K	L	5	White
Yellow	M	N	6	Black
Gray	P	Q	7	Black
Orange	R	S	8	Black

10. MOUNTING / BARRIERS

BACK CONNECTED (FRONT MOUNTED ONLY)	
Mounting Inserts	
A	6-32
B	ISO M3
FRONT CONNECTED (BACK MOUNTED ONLY) ¹⁴	
Back Mounting Foot Type	
C	Short
D	Short
E	Long
F	Long
Front Mounting Inserts (Optional Use)	
	6-32
	ISO M3
	6-32
	ISO M3

11. MAXIMUM APPLICATION RATING ¹⁵

A	65VDC, 120A	G	600VAC, 100A ¹⁶
B	125VDC, 120A	H	480VAC, 100A ¹⁶
C	120/240VAC, 100A	J	415VAC, 100A ¹⁶
D	240VAC, 100A	L	160VDC, 100A ¹⁶
E	277/480VAC, 100A ¹⁶	T	125VDC/240VAC, 100A
F	277VAC, 100A	W	125VDC/415VAC, 100A ¹⁶

12. AGENCY APPROVAL

B	UL 1077 / UL 508 Recognized & CSA Accepted
D	UL 1077 Recognized, CSA Accepted, & VDE Certified

Notes:

- VDE approval on 1-5 poles only. Standard multi-pole units identical poles except when specifying auxiliary switch (Note 4). For mixed ratings, consult factory.
- Switch Only & Series Trip construction available with either front or back connected terminals. Shunt construction available with back connected terminals. (Terminal Codes 1 & 2) only. Circuit Codes B,C & D are VDE approved.
- Switch Only construction; 30 amps or less select Current Rating Code 630; 31-70 amps, select Current Rating code 670; 71-100 amps, select Current Rating Code 810; 101-125 amps Select Current Rating Code 912. Switch Only is VDE approved only if tied to a protected pole.
- Auxiliary Switch available on Switch Only and Series Trip units. On multi-pole units, only one auxiliary switch is normally supplied mounted in the extreme right pole. Back mounted units require special mounting provisions when auxiliary switch is specified. VDE approval on Auxiliary Switch Codes 0,2,3 & 4 only.
- Voltage trip coils are not rated for continuous duty. Available only with frequency & delay codes 10 & 20. Series trip construction with a voltage coil is VDE approved only if tied to a protected pole.
- Frequency & delay codes 92, 94 & 96 are not VDE Certified.
- Current Coil Ratings 0,100 - 100 amps are VDE Certified.
- 125 A rating (Code 912) available as a Switch Only (Circuit Code A), rated 125 VDC (Code B).
- An Anti-Flash Over Barrier is supplied between poles on multi-pole units with 10-32 (Terminal Code 1), 1/4-20 (Code 2), M5 (Code A), and M6 (Code B) terminals per UL requirement.
- Box Wire Connector will accept #14 through 0 AWG. copper wire or #12 through 0 AWG. aluminum wire.
- Box wire connector with pressure plate for stranded wire. Consult factory
- Terminal Codes A,B,D,E,G & H are not VDE Certified.
- VDE approvals require Dual (I-O, ON-OFF) or I-O markings on all handles.
- Back Mounted breakers can also be front mounted by utilizing the proper front panel mounting inserts normally supplied. However, terminal connections must be made prior to mounting.
- Application ratings B, D, J, T & W are available with VDE.
- 415, 480 & 600 VAC ratings require 3 or 4 pole break 30 and 2 pole break 10.

Ordering Scheme

UL 489 Listed

Sample Part Number

E A 2 - B 0 - 24 - 450 - 1 2 A - C C

Selection 1 2 3 4 5 6 7 8 9 10 11 12

1. SERIES

E

2. ACTUATOR

A Handle, one per pole

3. POLES ¹

1 One 3 Three 5 Five
2 Two 4 Four 6 Six

4. CIRCUIT ²

B Series Trip (current) C Series Trip (voltage) ³

5 AUXILIARY SWITCH ⁴

0 without Auxiliary Switch 6 S.P.S.T. 0.110 Q.C. Terminals
2 S.P.D.T. 0.110 Q.C. Terminals 7 S.P.S.T. 0.110 Q.C. Terminals
3 S.P.D.T. 0.139 Solder Lug (Gold Contacts)
4 S.P.D.T. 0.110 Q.C. Terminals (Gold Contacts) 8 S.P.S.T. 0.187 Q.C. Terminals
9 S.P.D.T. 0.187 Q.C. Terminals

6. FREQUENCY & DELAY

10 DC Instantaneous ⁵ 24 50/60Hz Medium
12 DC Short 26 50/60Hz Long
14 DC Medium 62 50/60Hz Short, High-inrush
16 DC Long 64 50/60Hz Medium, High-inrush
20 50/60Hz Instantaneous ⁵ 66 50/60Hz Long, High-inrush
22 50/60Hz Short 74 DC, Medium, High-inrush
76 DC, Long, High-inrush

7. CURRENT RATING (AMPERES) ⁷

CODE	AMPERES						
020	0.020	235	0.350	430	3.000	614	14.000
025	0.025	240	0.400	435	3.500	615	15.000
030	0.030	245	0.450	440	4.000	616	16.000
035	0.035	250	0.500	445	4.500	617	17.000
040	0.040	255	0.550	450	5.000	618	18.000
045	0.045	260	0.600	455	5.500	620	20.000
050	0.050	265	0.650	460	6.000	622	22.000
055	0.055	270	0.700	465	6.500	624	24.000
060	0.060	275	0.750	470	7.000	625	25.000
065	0.065	280	0.800	475	7.500	630	30.000
070	0.070	285	0.850	480	8.000	635	35.000
075	0.075	290	0.900	485	8.500	640	40.000
080	0.080	295	0.950	490	9.000	650	50.000
085	0.085	410	1.000	495	9.500	660	60.000
090	0.090	512	1.250	610	10.000	670	70.000
090	0.095	415	1.500	710	10.500	680	80.000
210	0.100	517	1.750	611	11.000	690	90.000
215	0.150	420	2.000	711	11.500	810	100.000
220	0.200	522	2.250	612	12.000	811	110.000
225	0.250	425	2.500	712	12.500	812	120.000
230	0.300	527	2.750	613	13.000	912	125.000 ⁸

OR VOLTAGE COIL ⁵

CODE	RATING	TRIP VOLTS						
A06	6DC	5DC	A65	65DC	55DC	J48	48AC	40AC
A12	12DC	10DC	B25	120DC	100DC	J65	65AC	55AC
A18	18DC	15DC	J06	6AC	5AC	K20	120AC	65AC
A24	24DC	20DC	J12	12AC	10AC	L40	240AC	130AC
A32	32DC	25DC	J18	18AC	15AC			
A48	48DC	40DC	J24	24AC	20AC			

8. TERMINAL ⁷

	BACK CONNECTED (FRONT MOUNTED ONLY)	MAX. RATING
1 ⁸	10-32 Stud (All Terminals)	50 A
2 ⁸	1/4-20 Stud (All Terminals)	125 A
	FRONT CONNECTED (BACK MOUNTED ONLY)	
3 ⁹	Box Wire Connector (Line & Load)	100 A
C ¹⁰	Box Wire Connector with Pressure Plate (Line & Load)	100 A
4	10-32 Screw (Line & Load)	50 A
5	10-32 "Bus-Type" Screw (Line), 10-32 Screw (Load)	50 A
6 ⁹	10-32 "Bus-Type" Screw (Line), Box Wire Connector (Load)	100 A
F ¹⁰	10-32 "Bus-Type" Screw (Line), Box Wire Connector with Pressure Plate (Load)	100 A
7	1/4-20 Screw (Line & Load)	100 A
8	1/4-20 "Bus-Type" Screw (Line), 1/4-20 Screw (Load)	100 A
9 ⁹	1/4-20 "Bus-Type" Screw (Line), Box Wire Connector (Load)	100 A
J ¹⁰	1/4-20 "Bus-Type" Screw (Line), Box Wire Connector with Pressure Plate (Load)	100 A

9 ACTUATOR COLOR & LEGEND ¹²

Actuator Color	ON-OFF	Dual	Legend Color
White	B	1	Black
Black	D	2	White
Red	G	3	White
Green	J	4	White
Blue	L	5	White
Yellow	N	6	Black
Gray	Q	7	Black
Orange	S	8	Black

10. MOUNTING / BARRIERS

	BACK CONNECTED (FRONT MOUNTED ONLY)	
	Mounting Inserts	
A	6-32	
B	ISO M3	
	FRONT CONNECTED (BACK MOUNTED ONLY) ¹¹	
	Back Mounting Foot Type	Front Mounting Inserts (Optional Use)
C	Short	6-32
D	Short	ISO M3
E	Long	6-32
F	Long	ISO M3

11. MAXIMUM APPLICATION RATING

1	120 VAC	C	120/240 VAC, 100A ¹³
B	125 VDC	D	240 VAC, 100A

12. AGENCY APPROVAL

C	UL 489 Listed & CSA Certified
F	UL 489 Listed, CSA Certified, & VDE Certified

Notes:

- Standard multi-pole units identical poles except when specifying auxiliary switch (Note 4). For mixed ratings, consult factory. VDE Certification on 1-5 poles only.
- Series Trip construction available with either front or back connected terminals.
- Series Trip construction with a voltage coil is not available as a single pole unit and must be tied to a protected pole.
- On multi-pole units, only one auxiliary switch is normally supplied mounted in the extreme right pole per Figure A. Back mounted units require special mounting provisions when auxiliary switch is specified. VDE Certification on auxiliary switch codes 0, 2, 3 & 4 only.
- Voltage Trip Coils are not rated for continuous duty. Available only with Frequency & Delay Codes 10 & 20.
- Frequency & Delay Codes 92, 94 & 96 are not VDE Certified.
- Current Ratings under 0.100 amps are not VDE Certified.
- An Anti-Flash Over Barrier is supplied between poles on multi-pole units with 10-32 Stud (Terminal Code 1) or 1/4-20 Stud (Code 2) terminals per UL requirement.
- Box Wire Connector will accept #14 through 0 AWG. copper wire or #12 through 0 AWG. aluminum wire.
- Box Wire Connector with Pressure Plate for stranded wire. Consult factory.
- Back Mounted breakers can also be front mounted by utilizing the proper front panel mounting inserts normally supplied. However, terminal connections must be made prior to mounting.
- VDE Certification requires dual (I-O, ON-OFF) markings on all handles.
- Not available with VDE Certification.

[Configure Complete Part Number >](#)

[Browse Standard Parts >](#)

Dimensional Specs

inches [millimeters]

MOUNTING INSERTS:

#6-32[M3]THREADX.220[5.59]
MIN. DEEP (2 PLCS)/POLE

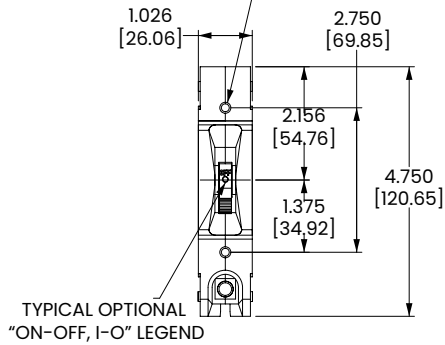

PANEL CUTOUT DETAIL



MULTI-POLE UNITS ARE
ASSEMBLED AT FACTORY
WITH COMMON HANDLE TIE

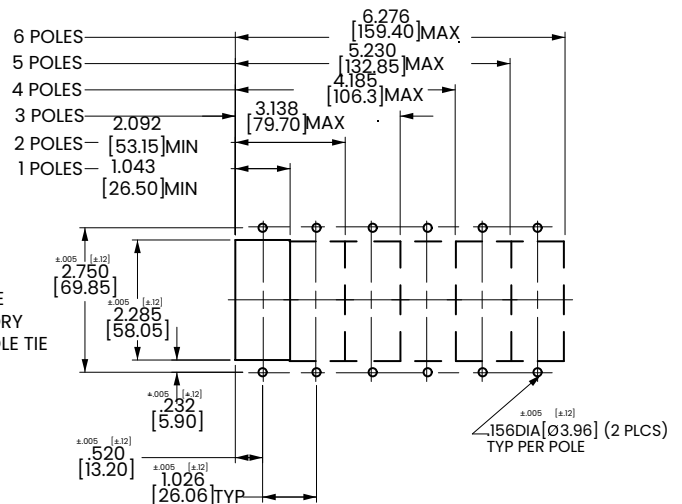

Notes:

- 1 1/4 -20 stud terminal in Series Trip circuit configuration shown.
- 2 A 3" min spacing must be provided between the circuit breaker arc venting area of back connected E-Series circuit breaker and grounded obstructions.
- 3 Tolerance ± 0.020 [.51] unless otherwise specified.
- 4 Circuit breakers must be mounted on vertical surface.

Dimensional Specs

inches [millimeters]

MOUNTING INSERTS:



PANEL CUTOUT DETAIL



Notes:

- 1 Tolerance ± 0.020 [.51] unless otherwise specified.
- 2 Box wire connector terminal in Series Trip circuit configuration shown.
- 3 Circuit breakers must be mounted on vertical surface.

Circuit & Terminal Diagram

inches [millimeters]

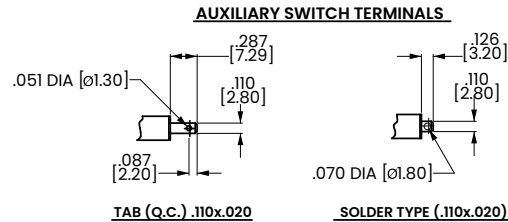
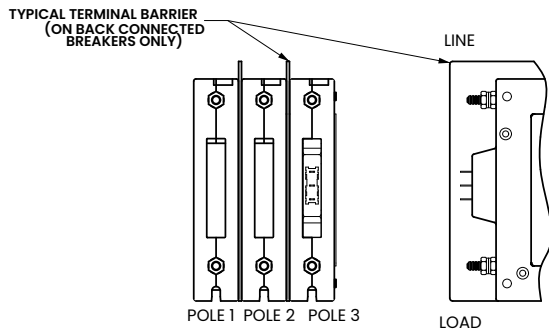

TABLE A TIGHTENING TORQUE SPECIFICATIONS		
THREAD SIZE TERMINAL TYPE	WIRE SIZE	TORQUE
#6-32 [M3] HARDWARE	—	7-9 IN-LBS [0.8-1.0 NM]
#10-32 THD TERMINAL SCREW	ALL	15-20 IN-LBS [1.7-2.3 NM]
1/4-20 THD TERMINAL SCREW	ALL	30-35 IN-LBS [3.4-4.0 NM]
#10-32 STUD	ALL	15-20 IN-LBS [1.7-2.3 NM]
1/4-20 STUD	ALL	30-35 IN-LBS [3.4-4.0 NM]
BOX WIRE CONNECTOR	14-10 AWG	35 IN-LBS [4.0 NM]
	8 AWG	40 IN-LBS [4.5 NM]
	6-4 AWG	45 IN-LBS [5.1 NM]
	3-1/0 AWG	50 IN-LBS [5.7 NM]

Notes:

- 1 Tolerance $\pm .020$ [.51] unless otherwise specified.
- 2 0-50 amps: 10-32 & M5 Studs .625 \pm .062/15.88 \pm 1.574 long.
- 3 51-120 amps: 1/4-20 & M6 Studs .750 \pm .062/19.05 \pm 1.574 long.

Time Delay

E-SERIES TIME DELAY VALUES											
TRIP TIME (SECONDS)	PERCENT OF RATED CURRENT										
	Delay	100%	125%	135%	150%	200%	400%	600%	800%	1000%	1200%
10	No Trip	May Trip	---	---	.001 - .038	.001 - .032	.001 - .021	.001 - .019	.001 - .019	.001 - .019	.001 - .019
12, 72	No Trip	.600 - 7.00	---	---	.330 - 2.00	.150 - .800	.033 - .160	.016 - .071	.010 - .048	.008 - .040	.008 - .040
14, 74	No Trip	11.0 - 110	---	---	6.00 - 45.0	3.00 - 18.0	.280 - 3.50	.013 - 1.50	.010 - .130	.009 - .090	.009 - .080
16, 76	No Trip	100 - 800	---	---	50.0 - 360	20.0 - 120	3.00 - 25.0	.020 - 11.0	.010 - .700	.009 - .230	.009 - .200
20	No Trip	May Trip	---	---	.001 - .040	.001 - .031	.001 - .020	.001 - .020	.001 - .020	.001 - .020	.001 - .020
22, 62	No Trip	.800 - 5.00	---	---	.400 - 2.30	.150 - .900	.034 - .170	.020 - .080	.012 - .051	.010 - .040	.009 - .040
24, 64	No Trip	7.20 - 90.0	---	---	4.40 - 35.0	2.00 - 15.0	.500 - 3.50	.025 - 1.60	.012 - .330	.010 - .070	.009 - .050
26, 66	No Trip	50.0 - 500	---	---	32.0 - 250	14.0 - 120	2.50 - 24.0	.320 - 7.00	.0125 - 3.10	.011 - .130	.010 - .055
30	No Trip	May Trip	---	---	.001 - .040	.001 - .032	.001 - .020	.001 - .020	.001 - .020	.001 - .020	.001 - .020
32, 92	No Trip	May Trip	.450 - 5.20	---	.330 - 2.30	.150 - .900	.033 - .170	.016 - .080	.009 - .051	.008 - .040	.008 - .040
34, 94	No Trip	May Trip	5.80 - 73.0	---	4.40 - 45.0	2.00 - 18.0	.280 - 3.60	.013 - 1.60	.010 - .330	.009 - .090	.009 - .080
36, 96	No Trip	May Trip	42.0 - 600	---	32.0 - 360	14.0 - 120	2.50 - 25.0	.020 - 11.0	.010 - 4.10	.009 - .330	.009 - .200

NOTES

Delay Curves 10,20,30: Breakers to hold 100% and must trip at 150% of rated current and greater within the time limit shown in these curves.
 Delay Curves 12,14,16,22,24,26,62,64,66,72,74,76: Breakers to hold 100% and must trip at 125% of rated current and greater within the time limit shown in these curves.
 Delay Curves 32,34,36,92,94,96: Breakers to hold 100% and must trip at 135% of rated current and greater within the time limit shown in these curves. All curves: Data shown represents breaker response at ambient temperature of 77°F (25°C) with no preloading; Breakers are mounted in standard wall-mount position. The minimum inrush pulse tolerance handling capacity on the above standard delays is 16 times rated current & 20 times rated current for high inrush delays based on a 60Hz 1/2 cycle, 8.33 ms pulse.

Instantaneous

AC

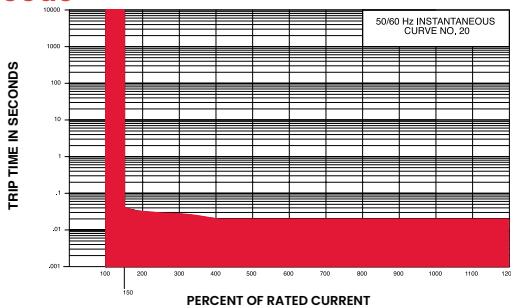

DC

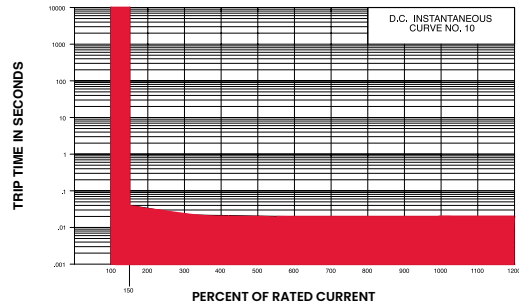

Short

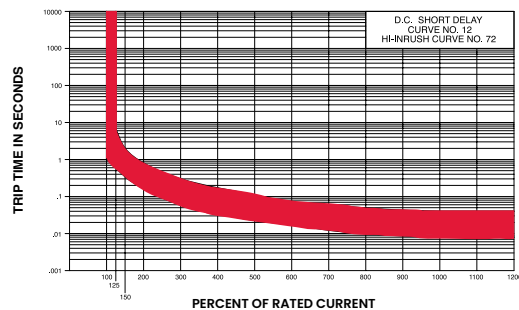
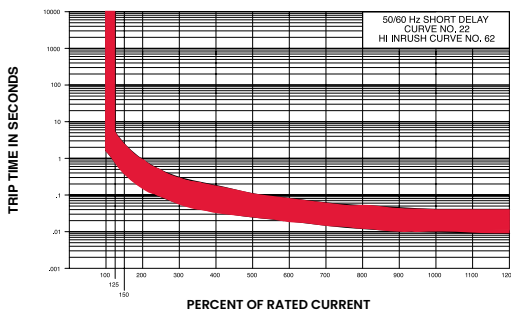

Medium

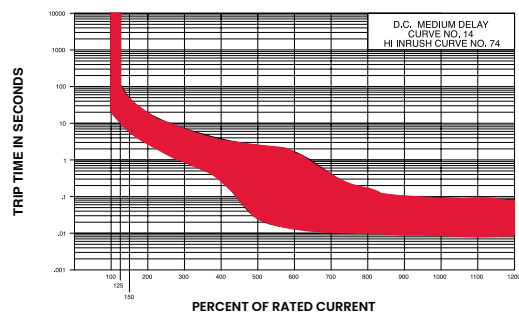
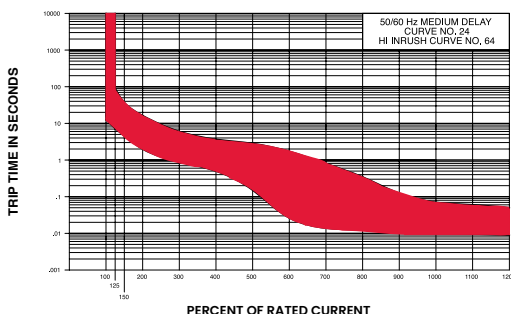

Long

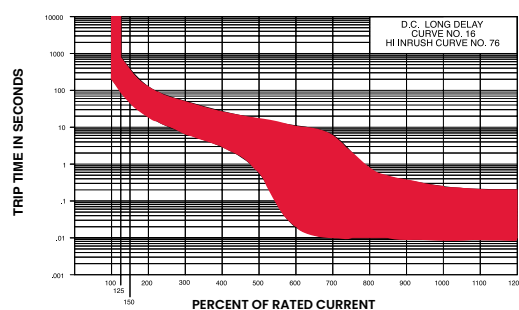
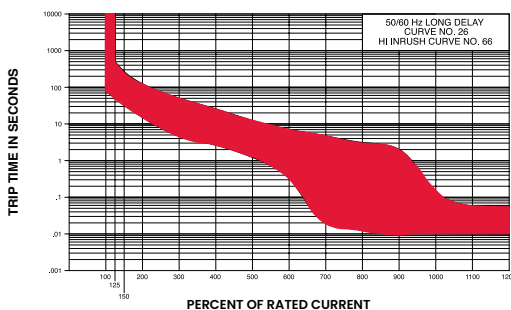

Time Delay

AC/DC

Instantaneous



Short

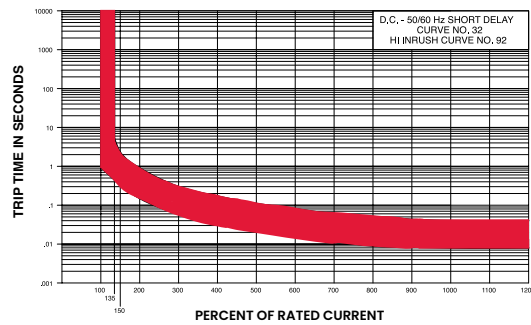

Medium

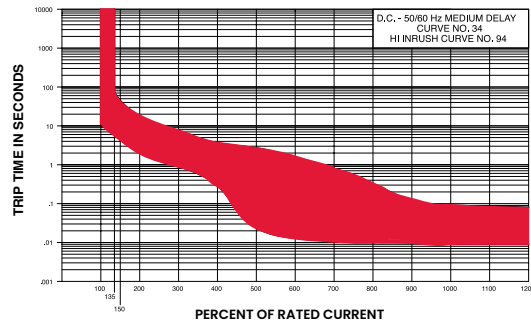

Long

