

## Car Charger Using ACT4533A

### FEATURES

- Wide input voltage range from 10V to 32V
- Transparent input voltage surge up to 40V
- 4.75V-5.25V during input and load transients
- 5% output voltage accuracy
- 125kHz switching frequency
- Standby input current <6mA
- 3.1A-3.6A accurate current limit
- Good EMC performance
- Thermal shutdown protection
- Over output voltage protection
- Cord compensation
- Over current protection

### SPECIFICATION

DESCRIPTION	CONDITION	MIN	TYP	MAX	UNITS
Input Voltage		10		32	V
Switching Frequency			125		kHz
No-load Standby Input current	Vin=12V no load		5.5		mA
	Vin=24V no oad		5		mA
Output Voltage		4.75	5	5.25	V
Output Current		3100		3600	mA
Ripple Voltage	Vin=12V, Io=3.1A		27.2		mVpp
	Vin=24V, Io=3.1A		42.4		
Efficiency at full load	Vin=12V, Io=3.1A		90.13		%
	Vin=24V, Io=3.1A		88.67		%
<b>ENVIRONMENTAL</b>					
ESD	Contact		4		kV
	Through air		8		kV
Ambient Temperature	Free convection	0		50	°C

## TABLE OF CONTENTS

1. Demo Board Photo.....	3
2. Schemati.....	3
3. PCB Layout.....	3
4. Bill of Materials .....	4
5. Functional Test.....	5
5.1. Output Regulation .....	5
5.2. Efficiency (Ta=25C) .....	5
5.3. Constant Current and Constant Voltage (Ta=25C) .....	6
5.4. Current Limit vs. Input Voltage .....	7
5.5. Power Loss .....	7
5.6. Standby Input Current .....	8
5.7. Ripple and Noise .....	8
5.8. Load Dynamic Response.....	9
5.9. Line Dynamic Response(Vin change from 12V to 40V, 1V/uS).....	9
5.10. Key Components Temperature Test (Ta=40C, burning in for 2 hours with CLA) .....	10
6. EMI TEST.....	10
6.1. Radiated EMI Test .....	10

## 1. DEMO BOARD PHOTO

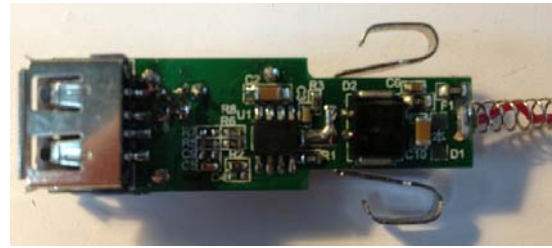
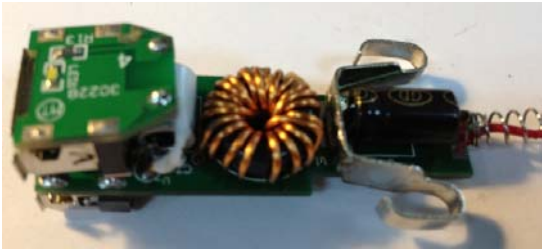

## 2. SCHEMATI

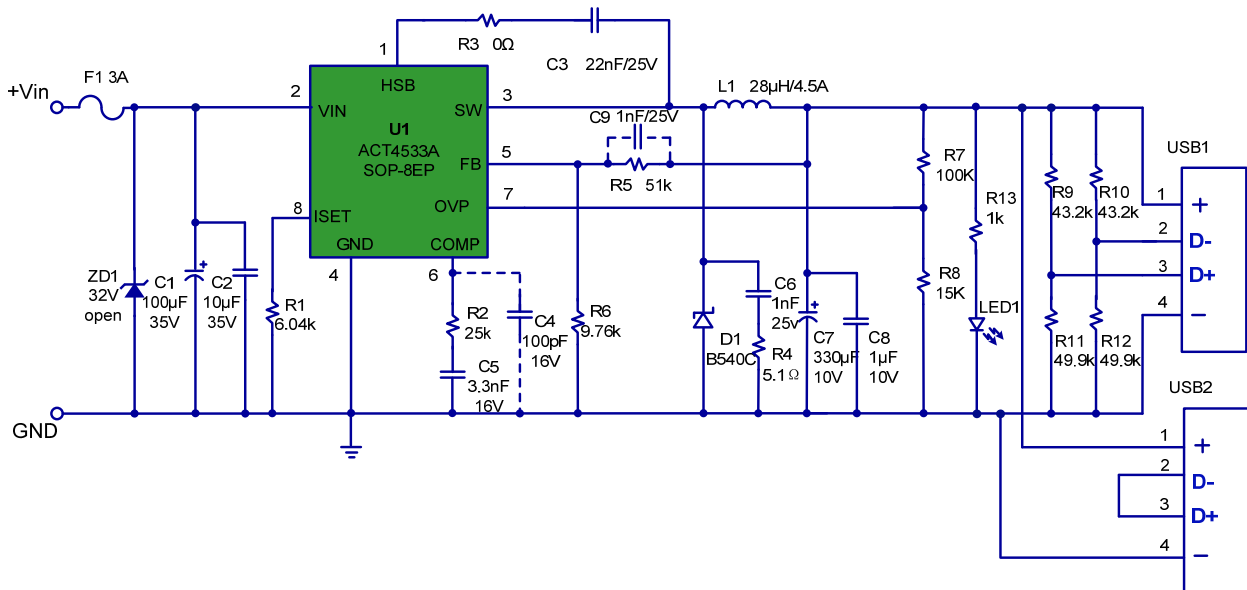

## 3. PCB LAYOUT

TOP LAYER

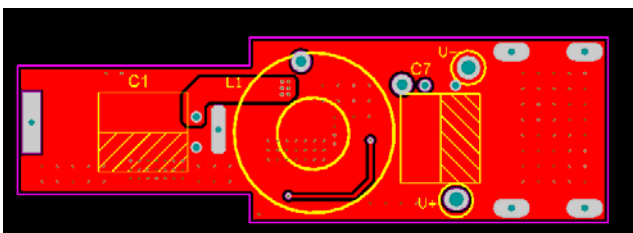

BOTTOM LAYER

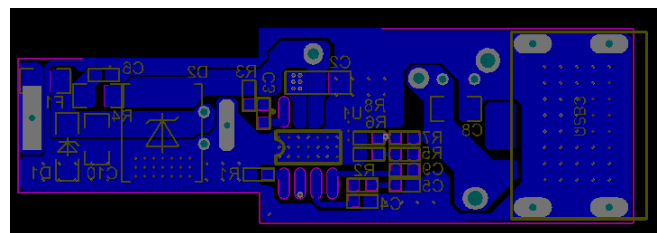

## 4. BILL OF MATERIALS

Item	Reference	Description	QTY	Manuf.
1	L1	Choke Coil, Dip, T11.5*5*4mm, phi=0.8mm, L=28uH	1	
2	D1	Schottky Diode, B540C, 40V/5A, SMC	1	Diodes
3	C1	Electrolytic capacitor, 100uF/35V, 6.3x11.5mm	1	Koshin
4	C2	Ceramic capacitor, 10uF/35V, X7R, 1206	1	Koshin
5	C3	Ceramic capacitor, 22nF/25V, X7R, 0603	1	Murata/TDK
6	C4	Ceramic capacitor, 100pF/16V, X7R, 0603(Optional)	1	Murata/TDK
7	C5	Ceramic capacitor, 3.3nF/16V, X7R, 0603	1	Murata/TDK
8	C6	Ceramic capacitor, 1nF/25V, X7R, 0603	1	Murata/TDK
9	C7	Solid capacitor, 330uF/10V, 7x8mm	1	Murata/TDK
10	C8	Ceramic capacitor, 1uF/10V, X7R, 0603	1	Murata/TDK
11	C9	Ceramic capacitor, 1nF/25V, X5R, 0603	1	Murata/TDK
12	F1	Fuse, 3A, 1206 ( Replaced by 0Ω 0805 chip resistor )	1	Murata/TDK
13	R1	Chip Resistor, 6.04KΩ, 1/16W, 1%, 0603	1	Murata/TDK
14	R2	Chip Resistor, 25KΩ, 1/16W, 5%, 0603	1	Murata/TDK
15	R3	Chip Resistor, 0Ω, 1/16W, 5%, 0603	1	Murata/TDK
16	R4	Chip Resistor, 5.1Ω, 1/16W, 5%, 0805	1	Murata/TDK
17	R5	Chip Resistor, 51KΩ, 1/16W, 1%, 0603	1	Murata/TDK
18	R6	Chip Resistor, 9.76KΩ, 1/16W, 1%, 0603	1	Murata/TDK
19	R7	Chip Resistor, 100KΩ, 1/16W, 1%, 0603	1	Murata/TDK
20	R8	Chip Resistor, 15KΩ, 1/16W, 1%, 0603	1	Murata/TDK
21	R9, R10	Chip Resistor, 43.2KΩ, 1/16W, 1%, 0603	2	Murata/TDK
22	R11, R12	Chip Resistor, 49.9KΩ, 1/16W, 1%, 0603	2	Murata/TDK
23	R13	Chip Resistor, 1KΩ, 1/16W, 5%, 0603	1	Murata/TDK
24	U1	IC, ACT4533A, SOP-8-EP	1	ACT
25	USB	USB Rev:A	2	
26	LED	LED, White, Dip	1	

## 5. FUNCTIONAL TEST

### 5.1. Output Regulation

VIN	Output Voltage at Max. load	Output Voltage at No load	Load regulation	Iload(max)
12V	5.146	5.035	2.20%	3.1A
16V	5.148	5.033	2.28%	
24V	5.150	5.034	2.30%	

### 5.2. Efficiency (Ta=25C)

VIN	Efficiency (%)				
	Io=100mA	Io=1000mA	Io=2100mA	Io=2400mA	Io=3100mA
10V	85.82	94.17	92.42	91.90	90.37
12V	82.67	93.19	92.04	91.54	90.13
16V	79.74	91.59	91.13	90.83	89.63
24V	71.79	89.39	89.99	89.73	88.67

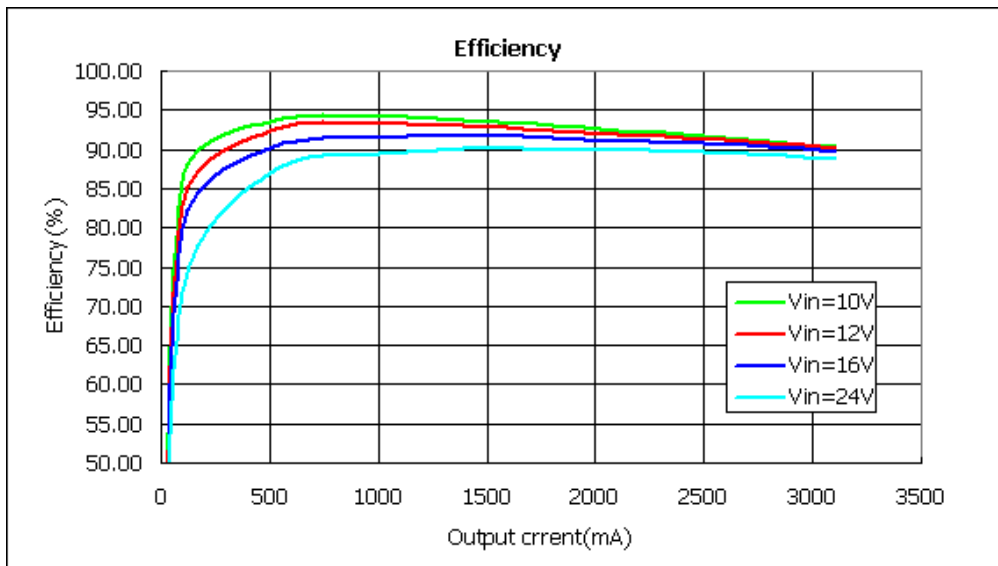

### 5.3. Constant Current and Constant Voltage (Ta=25C)

	Vin=10V		Vin=12V		Vin=18V		Vin=24V	
	Vout(V)	Iout(mA)	Vout(V)	Iout(mA)	Vout (V)	Iout(mA)	Vout(V)	Iout(mA)
<b>CC Load</b>	5.034	0	5.035	0	5.033	0	5.034	0
	5.072	1000	5.073	1000	5.073	1000	5.074	1000
	5.106	2100	5.109	2100	5.109	2100	5.112	2100
	5.117	2400	5.120	2400	5.120	2400	5.123	2400
	5.144	3100	5.146	3100	5.148	3100	5.150	3100
<b>CV Load</b>	4.85	3451	4.85	3464	4.85	3515	4.85	3515
	4.75	3452	4.75	3465	4.75	3515	4.75	3515
	4.5	3454	4.5	3467	4.5	3517	4.5	3515
	4	3457	4	3471	4	3518	4	3515
	3	3464	3	3476	3	3524	3	3513
	2	3468	2	3479	2	3528	2	3511
	1	3318	1	3315	1	3325	1	3300
	0	3339	0	3431	0	3365	0	3464

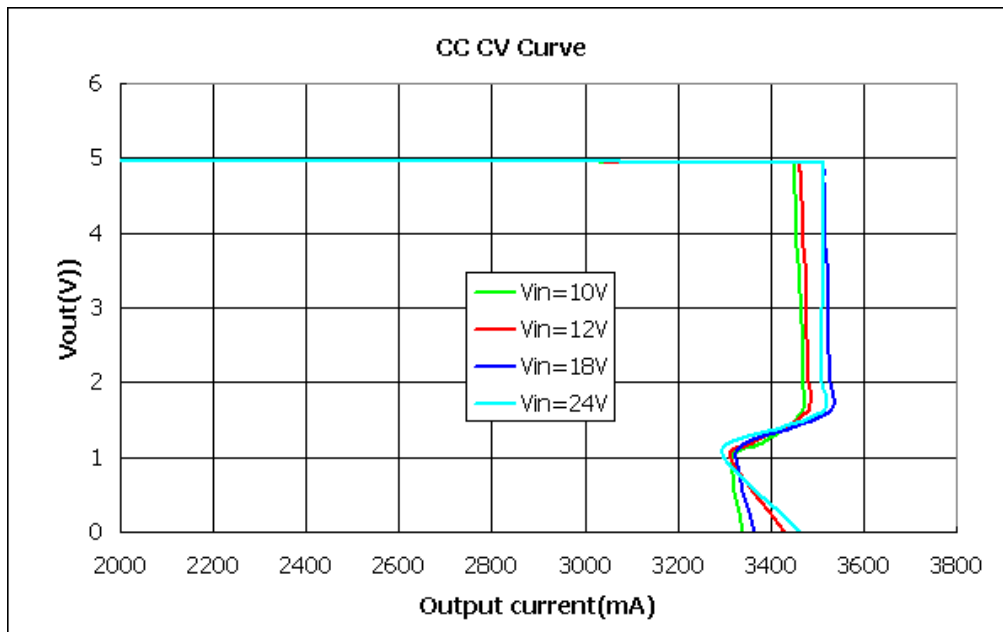

## 5.4. Current Limit vs. Input Voltage

No Wind ( Test Condition : CV load 4.7V, Ta=25C)

Vin (V)	10	11	12	13	14	15	16	18	20	24	28	30	32
Iout (A)	3451	3459	3467	3475	3470	3480	3500	3517	3504	3512	3526	3530	3535

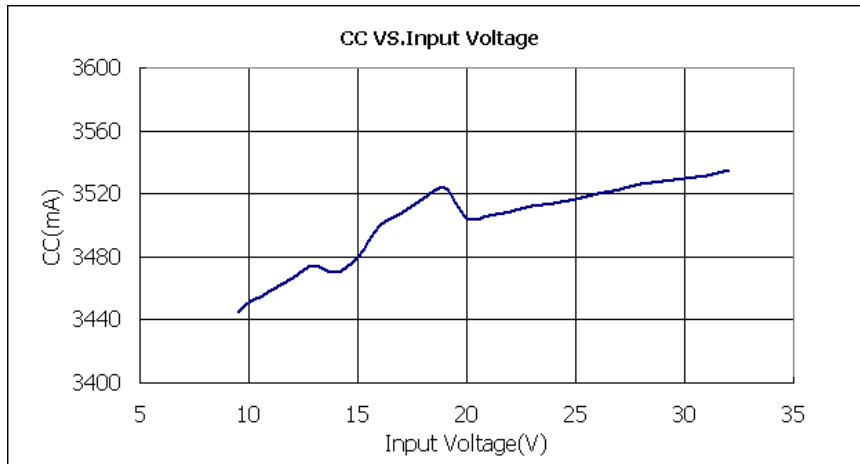

## 5.5. Power Loss

Vin	Power loss (W)					
	Io=0mA	Io=100mA	Io=2100mA	Io=2100mA	Io=2400mA	Io=3100mA
Vin=10V	0.05	0.08	0.31	0.88	1.08	1.7
Vin=12V	0.07	0.11	0.37	0.93	1.14	1.75
Vin=16V	0.08	0.13	0.47	1.04	1.24	1.85
Vin=24V	0.13	0.20	0.60	1.19	1.41	2.00

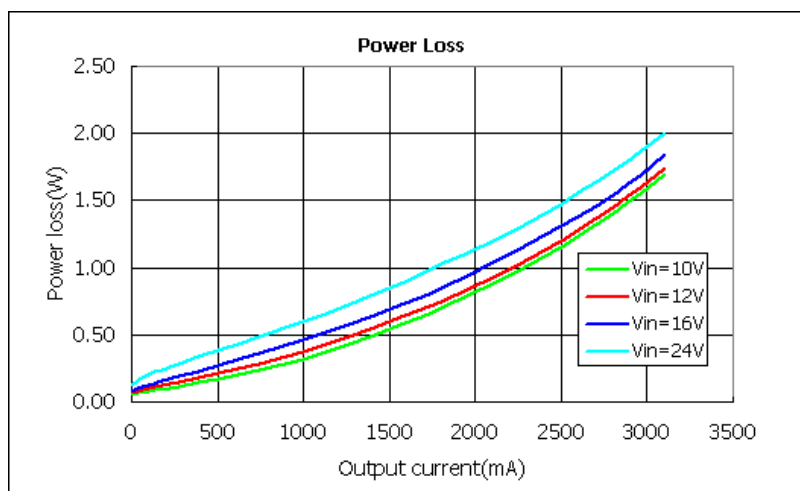

## 5.6. Standby Input Current

Test Conditions	Input Current (mA)	Power Loss at No Load (W)
Vin=10V	5.3	0.05
Vin=12V	5.57	0.07
Vin=16V	5.04	0.08
Vin=24V	5.35	0.13

## 5.7. Ripple and Noise

Vin=12V 1A output load

Vin=12V 3.1A output load

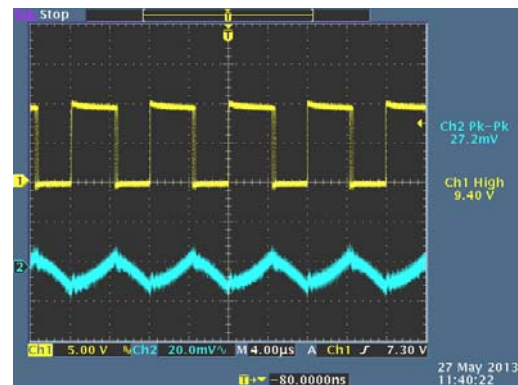
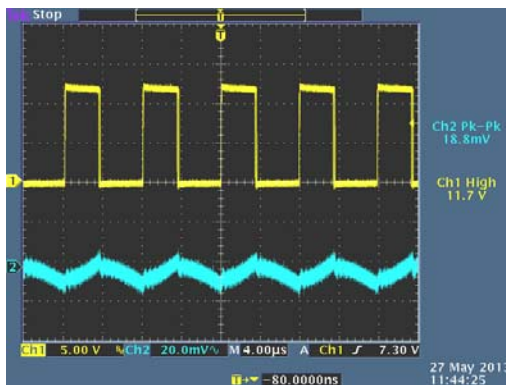

Vin=24V 1A output load

Vin=24V 3.1A output load

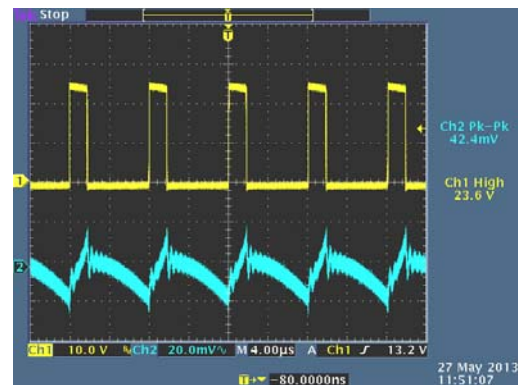
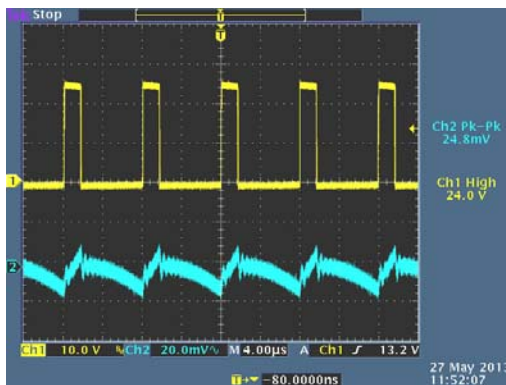

Ripple & noise are measured by using 20MHz bandwidth limited oscilloscope.

Test Conditions	Output Ripple at 1A Load (mV)	Output Ripple at 3.1A Load (mV)
Vin=12V	18.8	27.2
Vin=24V	24.8	42.4



## 5.8. Load Dynamic Response

Vin=12V load step 80mA-1A -80mA

Vin=12V load step 1A-2.4A-1A

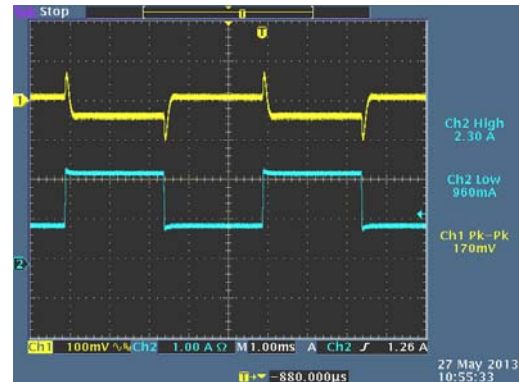
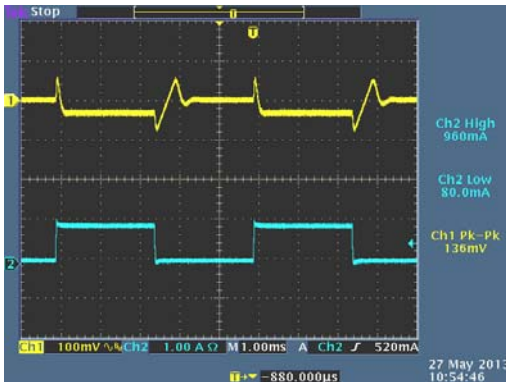

Vin=24V load step 80mA-1A -80mA

Vin=24V load step 1A-2.4A-1A

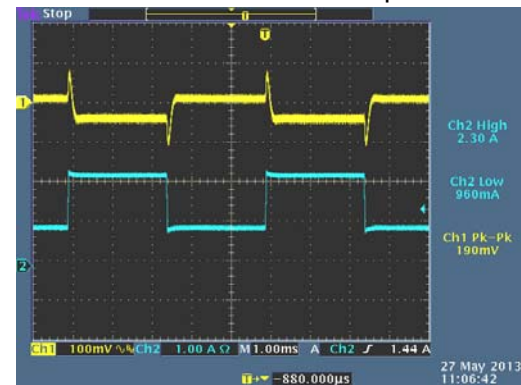
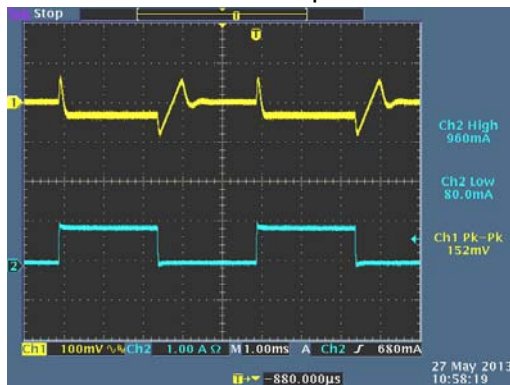

## 5.9. Line Dynamic Response(Vin change from 12V to 40V , 1V/uS)

Iout=1A

Iout =3.1A

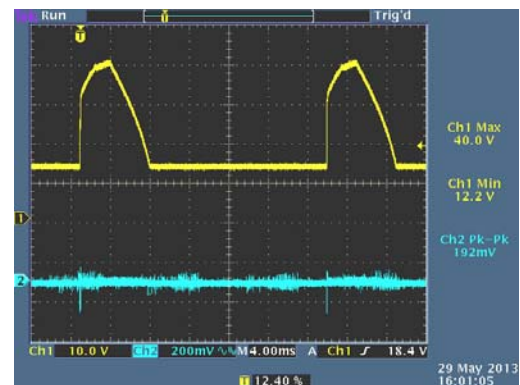
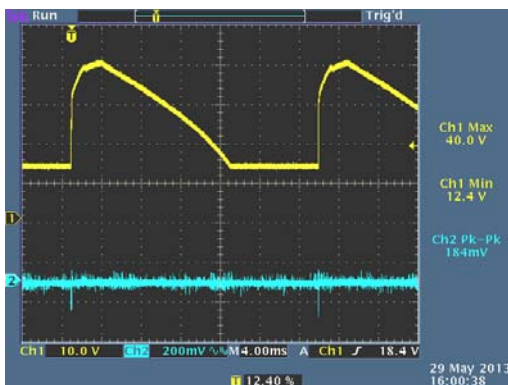

## 5.10. Key Components Temperature Test (Ta=40C, burning in for 2 hours with CLA)

Vin/Iout	IC	Diode	Inductor
12V/3.1A	108.6	90.8	89.7
24V/3.1A	112.2	103.6	95.5

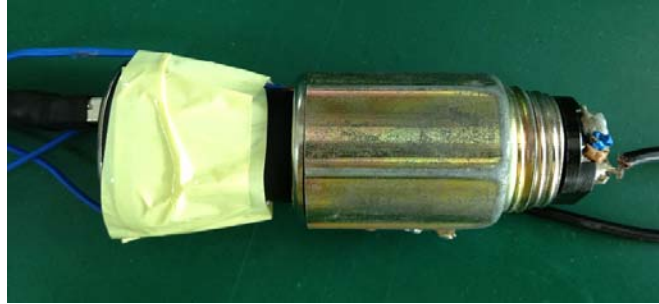

## 6. EMI TEST

### 6.1. Radiated EMI Test

Vin=12V Io=3.1A Horizontal



No. 1350, Lianxi Rd, Pudong New District, Shanghai, P.R.China  
Tel: 021-50275215  
Fax: 021-50275126  
Mail: winter.wang@unilab.cn

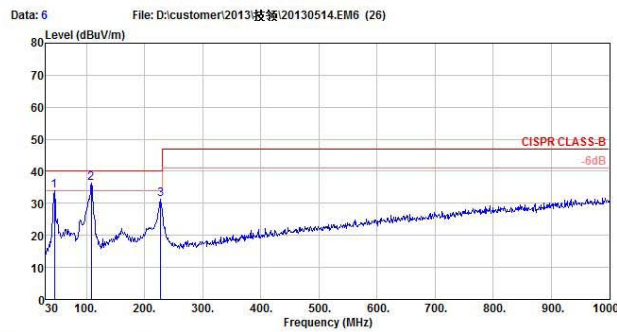

Site : chamber  
Condition : CISPR CLASS-B 3m VULB9160 HORIZONTAL  
EUT :  
Model Name : ACT4533A 5V3.4A DEMO2 #1  
Temp/Humi : 21 °C / 52 %  
Power Rating : aC 230v/50Hz  
Mode :  
Memo : BST:22nF ,SNUBBER:1nF+5.1ohm

	Freq	Level	Factor	Cable Loss	Preamp	Limit	Over	Remark
	MHz	dBuV	dB/m	dB	dB	dBuV/m	dBuV/m	dB
1 !	44.55	20.40	12.75	0.88	0.00	34.03	40.00	-5.97 Peak
2 pp	108.57	23.95	10.90	1.40	0.00	36.25	40.00	-3.75 Peak
3	227.88	18.03	11.14	2.06	0.00	31.23	40.00	-8.77 Peak