

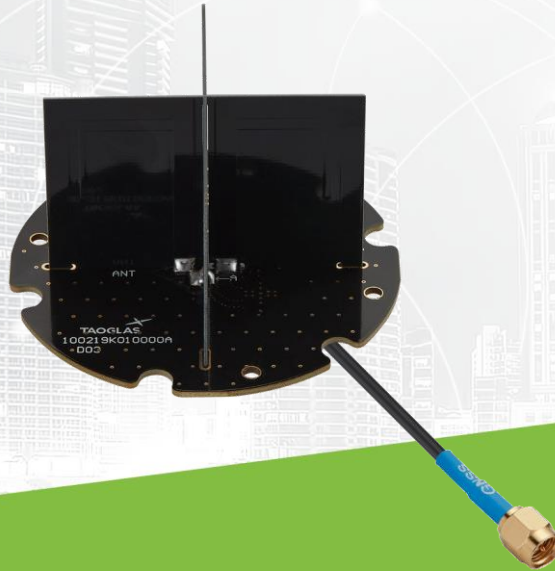

# TAOGLAS®



# Datasheet

## Embedded Cross Dipole Active Multiband GNSS Antenna

**Part No:**  
EAHP.50.01.0100D

### Description:

Embedded Active Multiband High Precision GNSS Antenna  
With 100mm RG-174 and SMA(M)

### Features:

Bands Covered:

- GPS/QZSS (L1/L2)
- GPS/QZSS/IRNSS (L5)
- QZSS (L6)
- Galileo (E1/E5a/E5b/E6)
- GLONASS (G1/G2/G3)
- BeiDou (B1/B2a/B2b/B3)

Excellent out-of-band rejection

Cable: 100mm RG-174

Connector: SMA(M) Straight

CE Certified

Dimensions:  $\varnothing 75 \times 42$ mm

RoHS & Reach Compliant

1. Introduction	3
2. Specifications	4
3. Antenna Characteristics	7
4. Active Antenna Characteristics	12
5. Radiation Patterns	14
6. Field Test Data	21
7. Mechanical Drawing	23
8. Packaging	25
Changelog	

---

Taoglas makes no warranties based on the accuracy or completeness of the contents of this document and reserves the right to make changes to specifications and product descriptions at any time without notice. Taoglas reserves all rights to this document and the information contained herein. Reproduction, use or disclosure to third parties without express permission is strictly prohibited.



# 1. Introduction

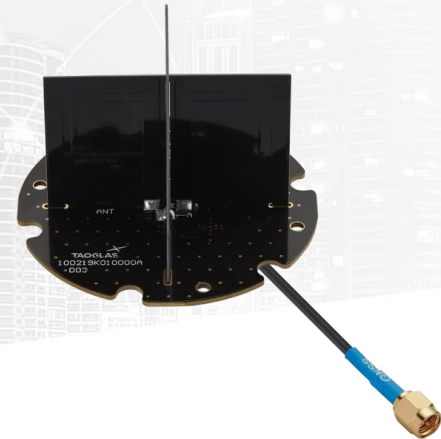

The Taoglas EAHP.50 is an embedded active multi-band GNSS antenna that has been carefully designed for high performance cm-level positional accuracy on the full GNSS spectrum. Bands covered include GPS/QZSS L1/L2/L5, GLONASS G1/G2/G3, Galileo E1/E5a/E5b/E6, BeiDou B1/B2a/B2b/B3, QZSS L6, NAVIC L5, as well as SBAS (WAAS/EGNOS/GAGAN/SDCM/SNAS. This allows the user to achieve higher location accuracy, as well as stability of position tracking in urban environments with their device.

The EAHP.50 has excellent performance across the full bandwidth of the antenna and its design has an even gain across the hemisphere giving almost excellent, broad axial ratio which in turn makes it resilient to multipath rejection and excellent phase centre stability. The LNA used in the EAHP.50 ensures excellent out of band rejection and provides excellent positioning stability and reliability of GNSS signals.

Typical applications for the EAHP.50 include:

- Autonomous Driving
- Precision Positioning for Robotics
- Precision Agriculture
- Inventory Management & Container tracking
- Telematics & Asset Tracking
- Timing Accuracy Synchronization

The EAHP.50 is the latest addition to an ongoing product road map of high precision antennas by Taoglas. For RTK applications, when used on the base and/or the rover, the EAHP.50 can achieve genuine cm-level accuracy.

Cable and connectors are customizable. Please contact your regional Taoglas customer support team for further information.

## 2. Specifications

GNSS Frequency Bands Covered							
GPS	L1	L2	L5				
	■	■	■				
GLONASS	G1	G2	G3				
	■	■	■				
Galileo	E1	E5a	E5b	E6			
	■	■	■	■			
BeiDou	B1	B2a	B2b	B3			
	■	■	■	■			
QZSS (Regional)	L1	L2C	L5	L6			
	■	■	■	■			
IRNSS (Regional)	L5						
	■						
SBAS	L1/E1/B1	L5/B2a/E5a	G1	G2	G3		
	■	■	■	■	■		

\*SBAS systems: WASS(L1/L5), EGNOS(E1/E5a), SDCM(G1/G2/G3), SNAS(B1,B2a), GAGAN(L1/L5), QZSS(L1/L5), KAZZ(L1/L5).

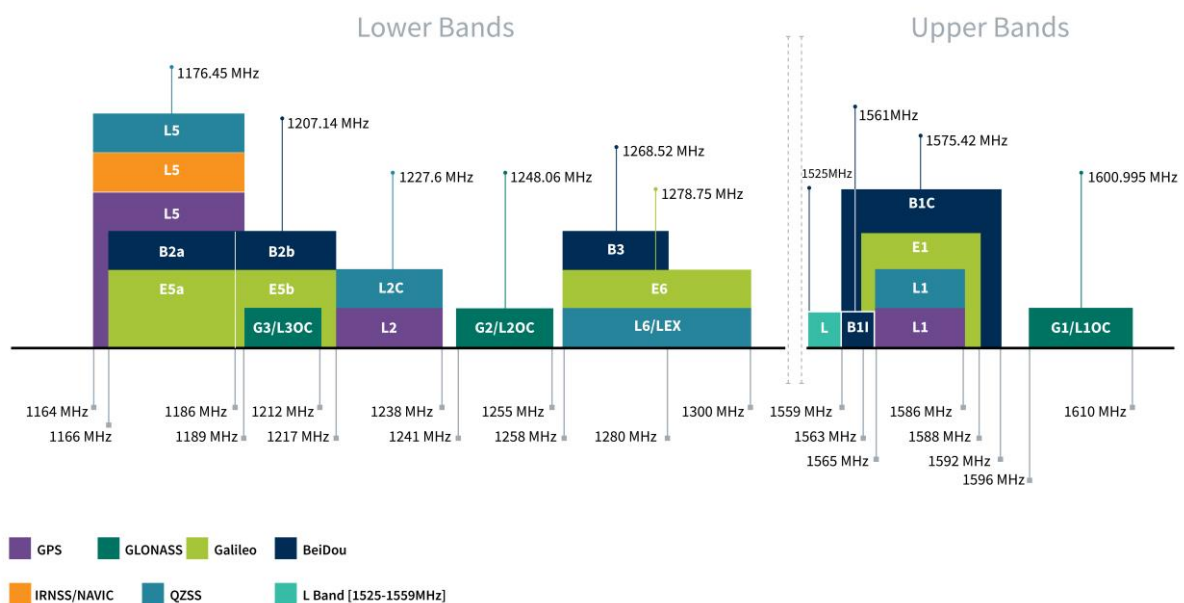

GNSS Bands and Constellations

GNSS Electrical						
Frequency (MHz)	1176.45	1227.6	1278.75	1561	1575.42	1602
VSWR (max.)	1.3:1	1.3:1	1.5:1	1.5:1	1.5:1	1.4:1
Passive Antenna Efficiency (%)	44.3	50.6	48	53	59	59
Passive Antenna Gain at Zenith (dBi)	4.3	4.5	3.9	4.7	5.1	4.6
Average Gain (dB)	-3.5	-3	-2.8	-2.7	-2.3	-2.3
Axial Ratio (dB) Ground Plane	1.2	1	1.5	1.5	1.5	1.9
Group Delay (ns)	5	5	4	15	15	15
PCO (cm)	0.5	0.01	0.6	1	1	1
PCV (cm)	1.9	1.1	1.04	0.6	0.6	0.6
Polarization	Right-Hand Circularly Polarized (RHCP)					
Impedance	50Ω					
Cable	100mm RG-174 as Standard					
Connector	SMA(M) Straight as Standard					

**Note:** The antenna was tested on a 30 x 30 cm ground plane

LNA and Filter Electrical Properties							
Frequency (MHz)	L5 1176.45	GAL E5b 1207	GPS L2 1227	L6/E6 1278.75	B1 1561	L1 1575.42	L1PT 1602
Gain (typical)	25 dB	27 dB	26 dB	24 dB	25 dB	27 dB	25 dB
Noise Figure (typical)	5.0 dB	4.3 dB	4.1 dB	3.8 dB	3.0 dB	2.8 dB	2.6 dB
Current Draw (typical)	< 20 mA						
Input Voltage	+1.8 to +5 VDC						
Out-Of-Band Attenuation (dB)	100 - 900 MHz				> 45		
	900 - 1000 MHz				> 30		
	1350 - 1520 MHz				> 25		
	1700 - 2000 MHz				> 35		
	2000 - 6000 MHz				> 45		

Mechanical	
Height	42 mm
Planner Dimension	75 mm Diameter
Cable*	100mm of RG-174 as standard
Connector*	SMA(M)ST as standard
Weight	31g
Environmental	
Temperature Range	-40°C to 85°C
Humidity	Non-condensing 65°C 95% RH
RoHS Compliant	Yes
REACH Compliant	Yes
RED Directive Compliant	Yes

\*Cable and connectors are fully customizable.

### 3. Antenna Characteristics

#### 3.1 Block Diagram

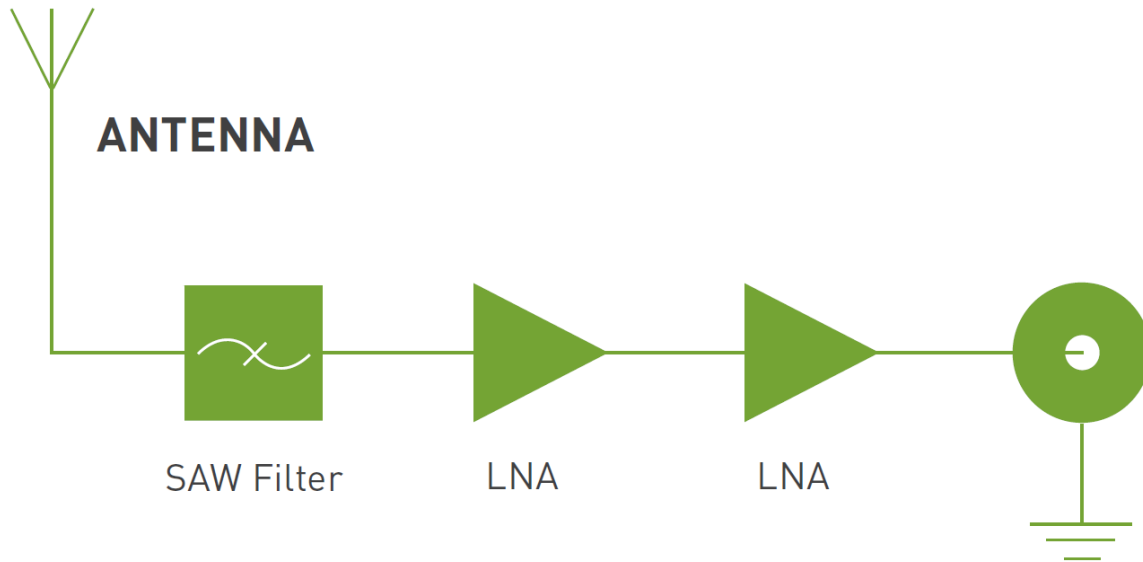

#### 3.2 Return Loss

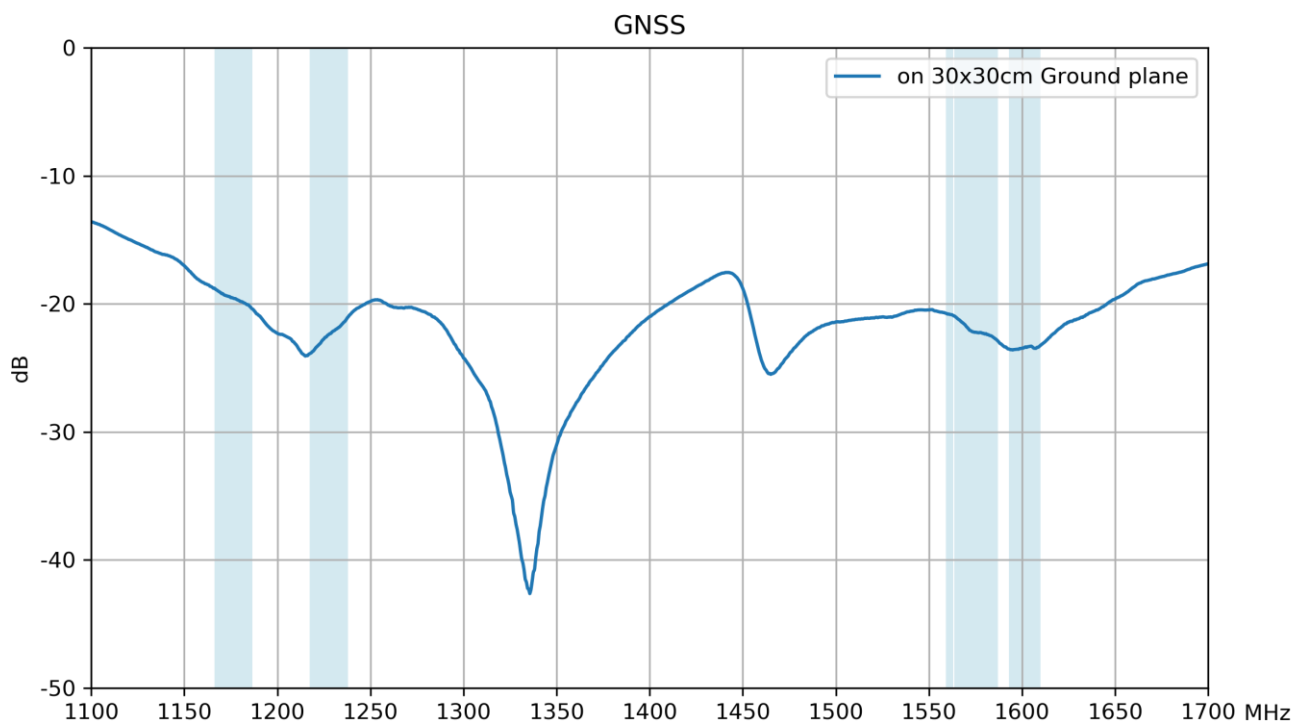

### 3.3 Efficiency

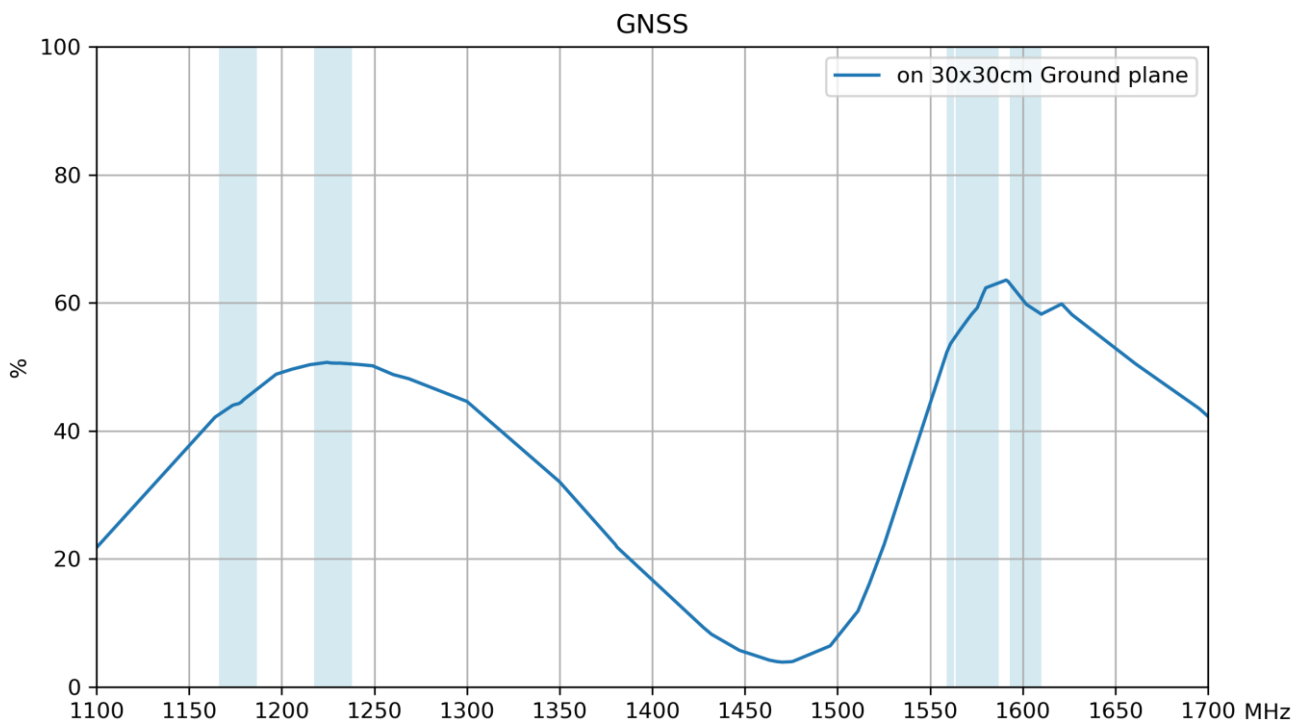

### 3.4 Average Gain

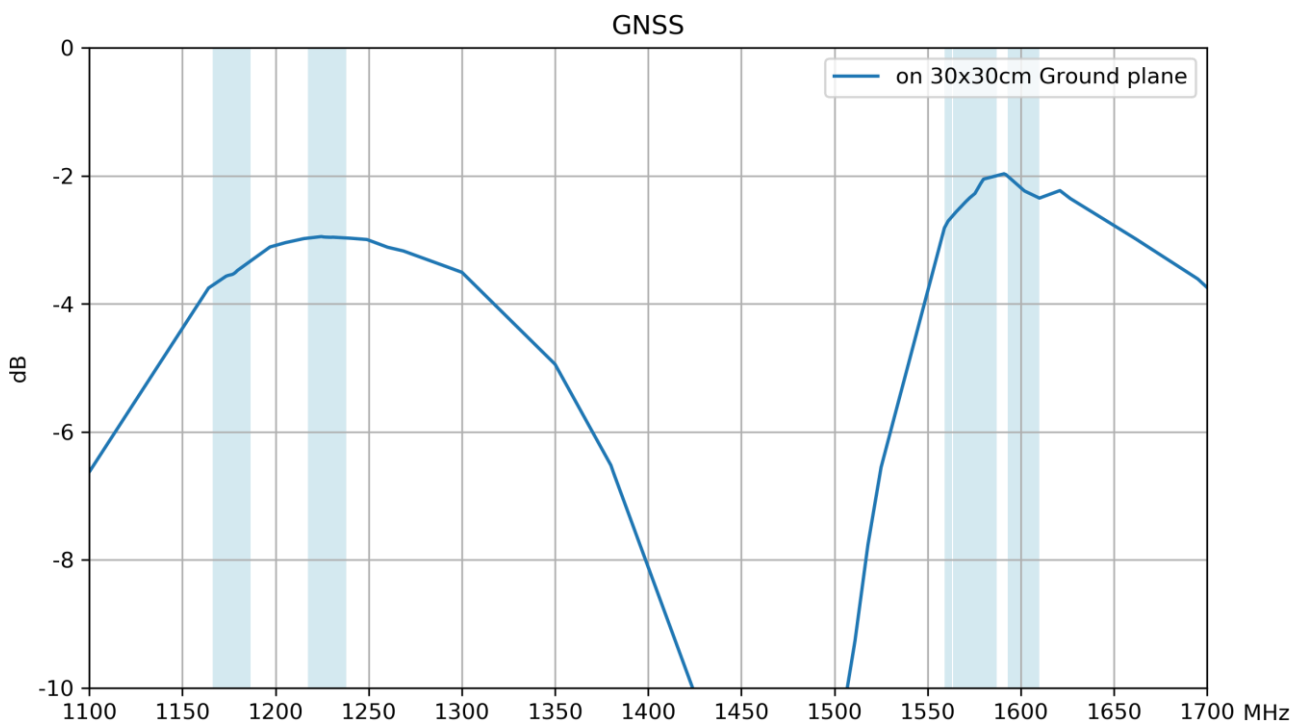



### 3.5 Peak Gain

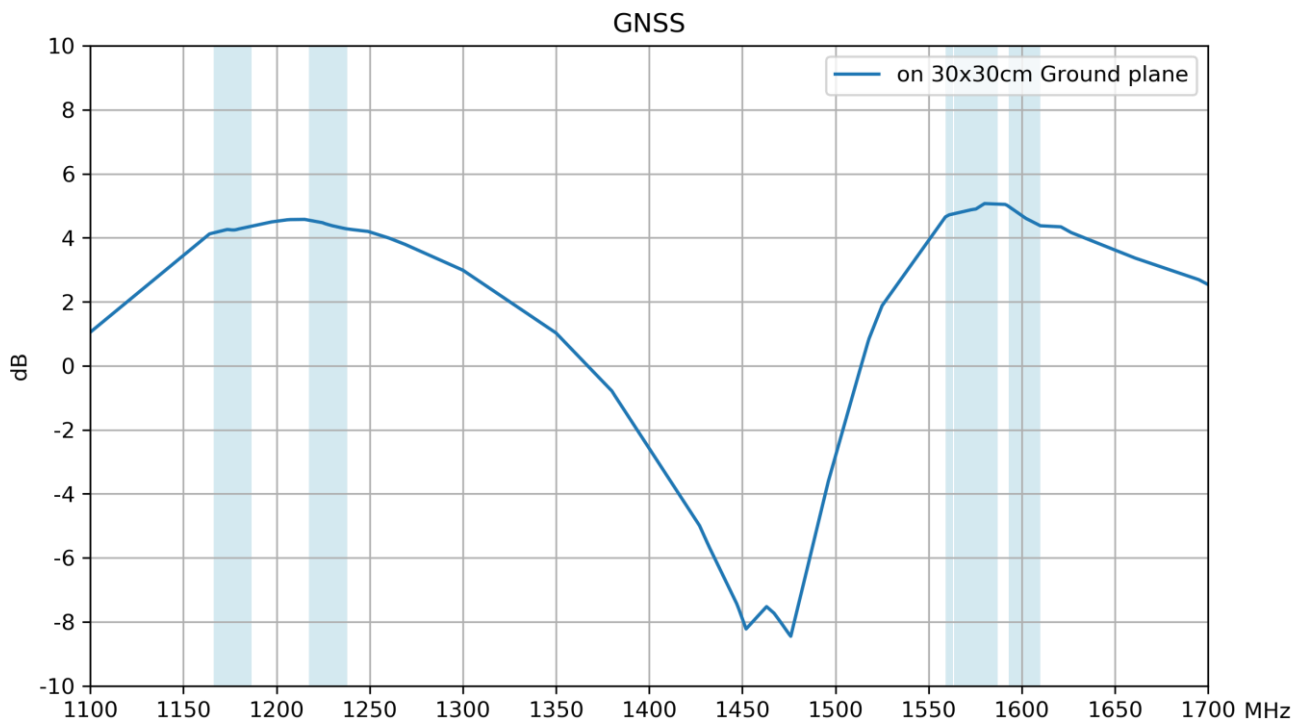

### 3.6 Axial Ratio @ 1176MHz

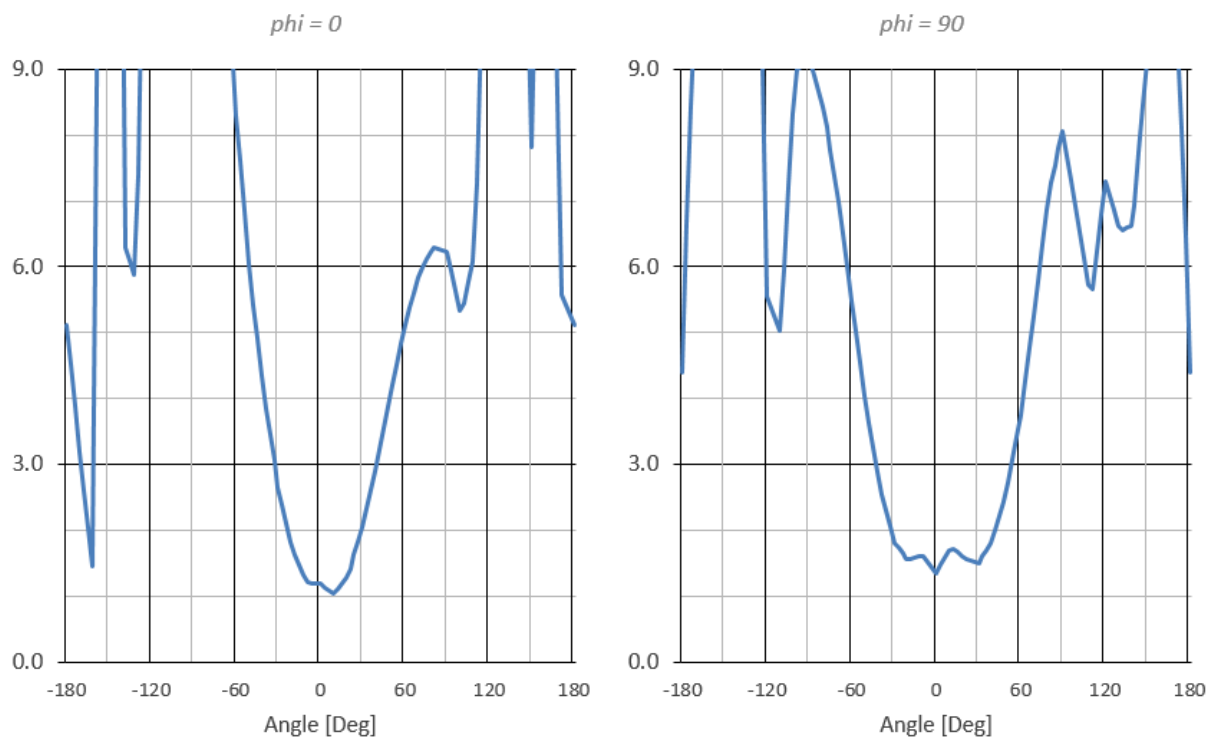

### 3.7 Axial Ratio @ 1227MHz

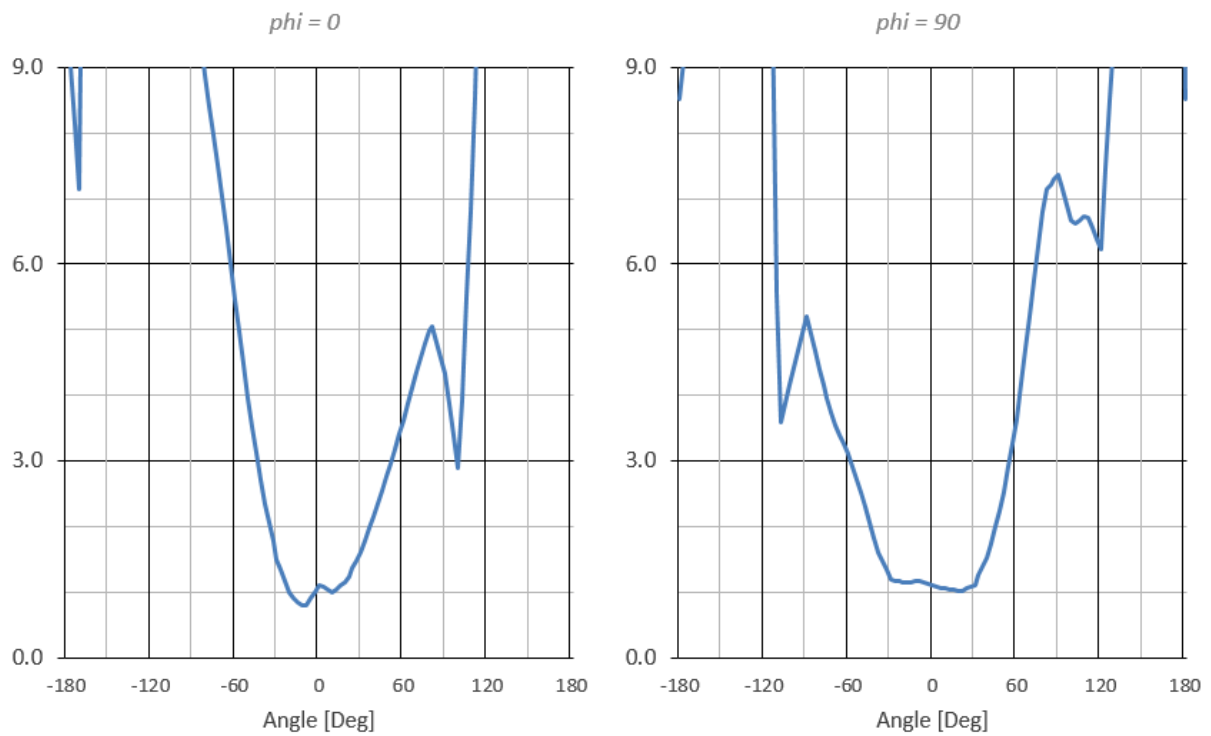

### 3.8 Axial Ratio @ 1561MHz

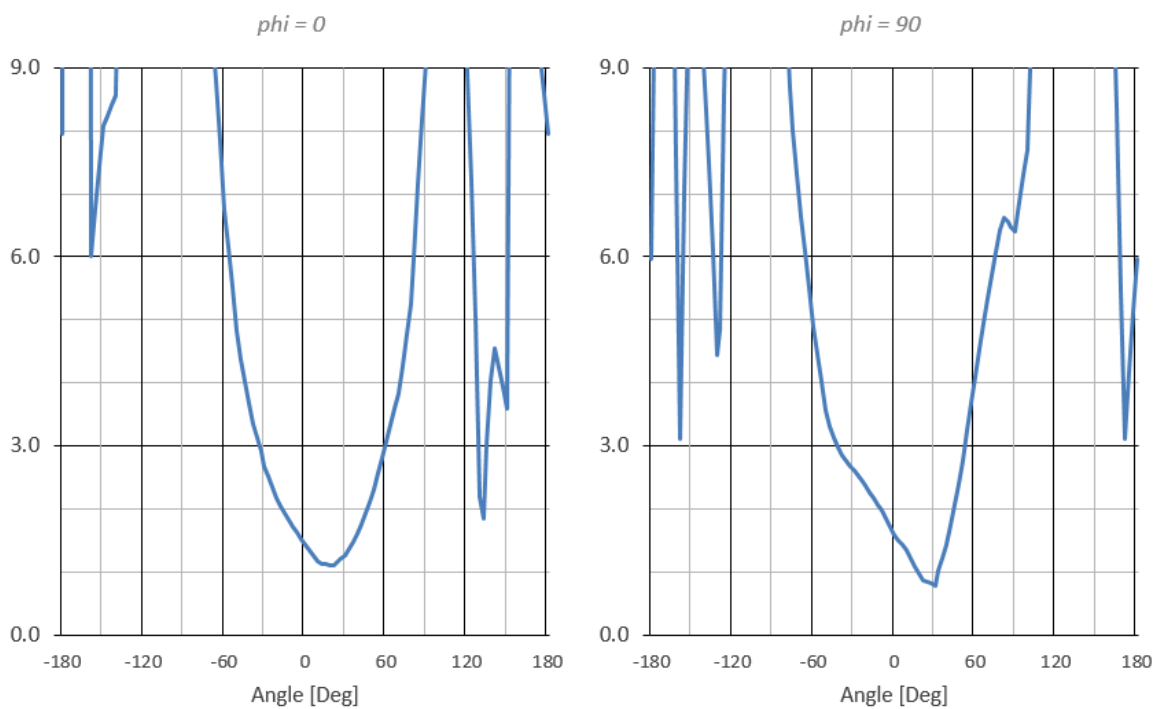

### 3.9 Axial Ratio @ 1575.42MHz

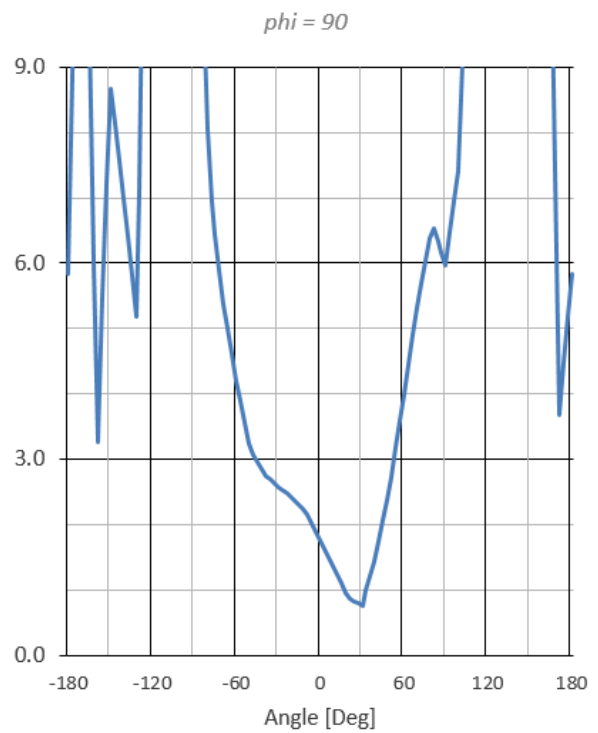
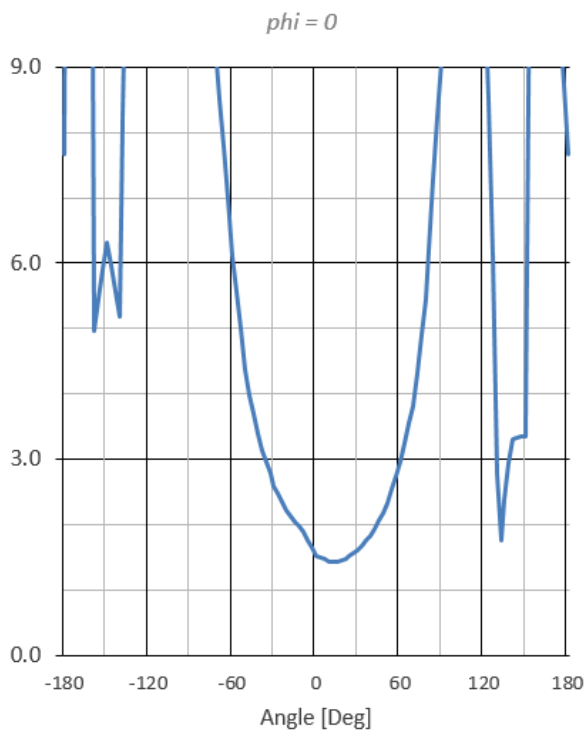

### 3.10 Axial Ratio @ 1602MHz

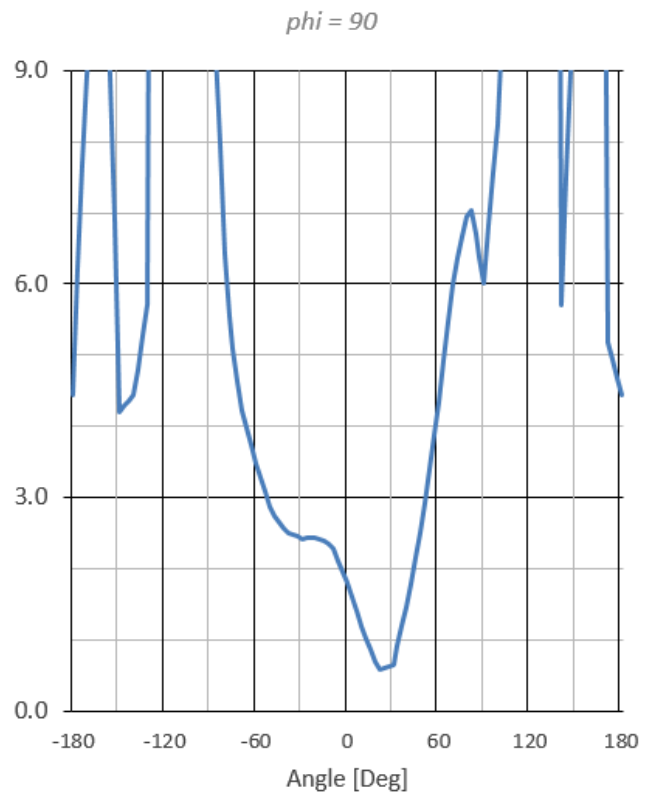
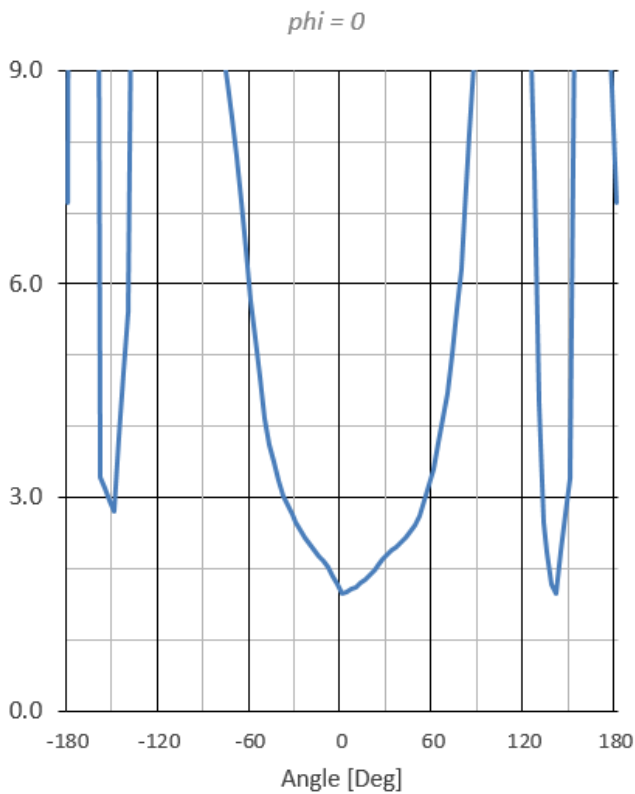

## 4. Active Antenna Characteristics

### 4.1 LNA Gain @ 3V

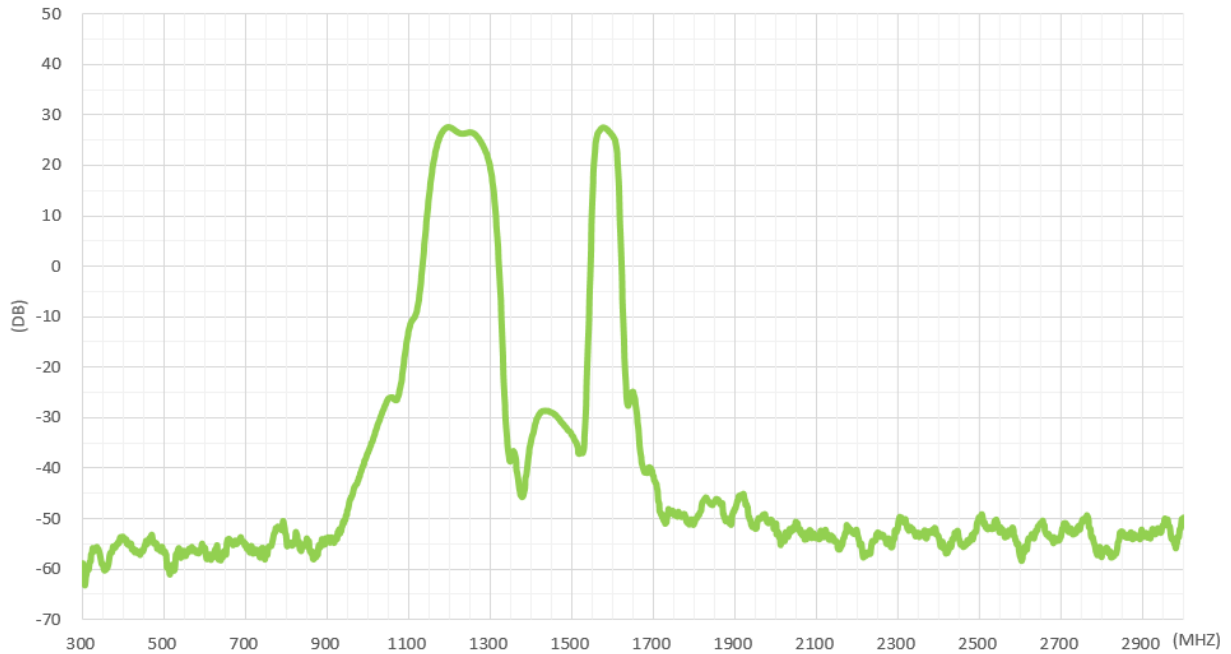

### 4.2 Noise Figure @ 3V (1120-1320MHz)

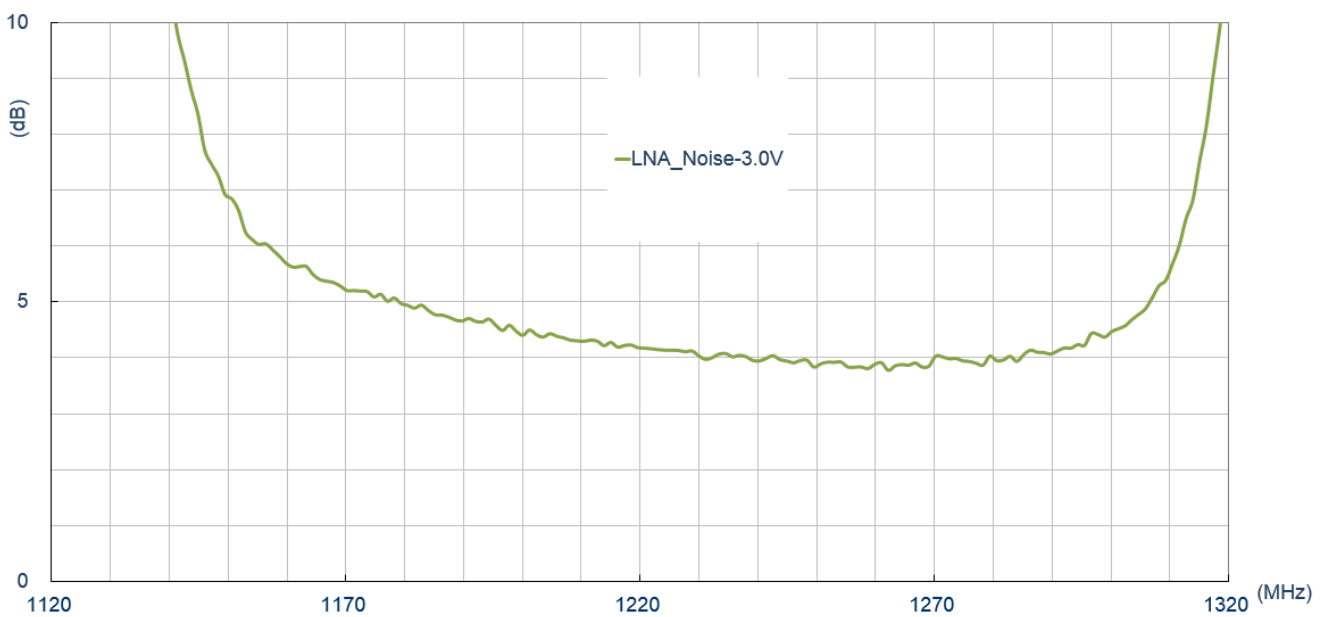

4.3 Noise Figure @ 3V (1530-1630MHz)

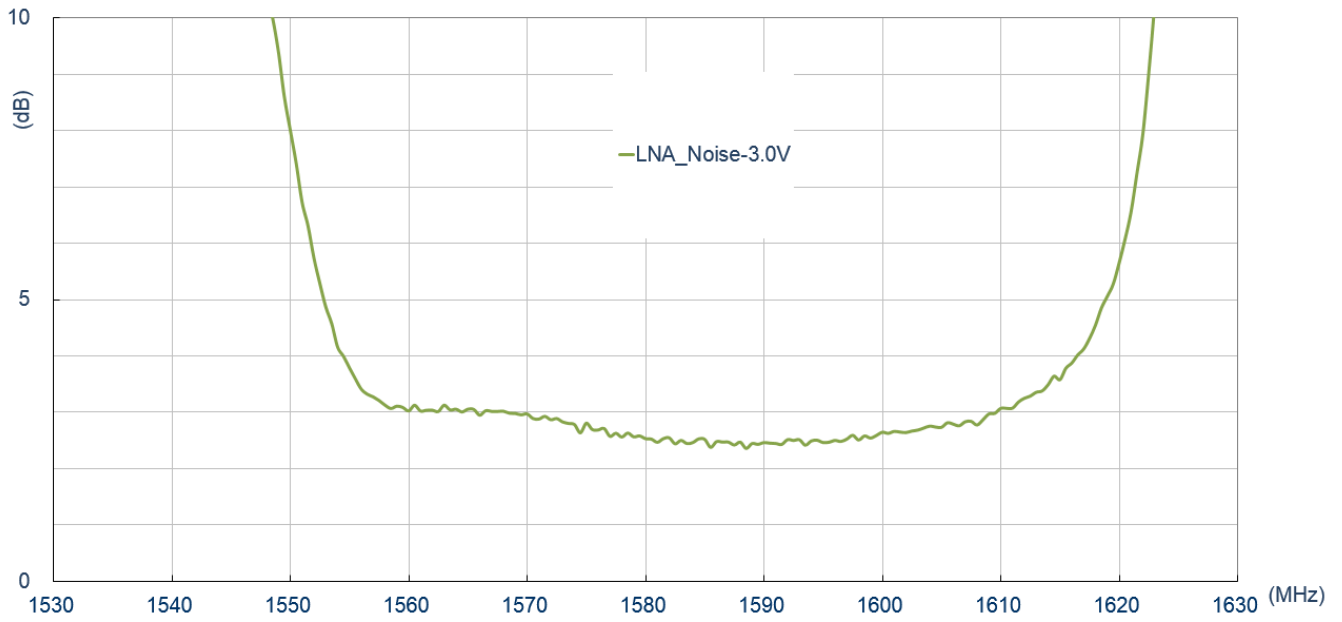

## 5. Radiation Patterns

### 5.1 Test Setup

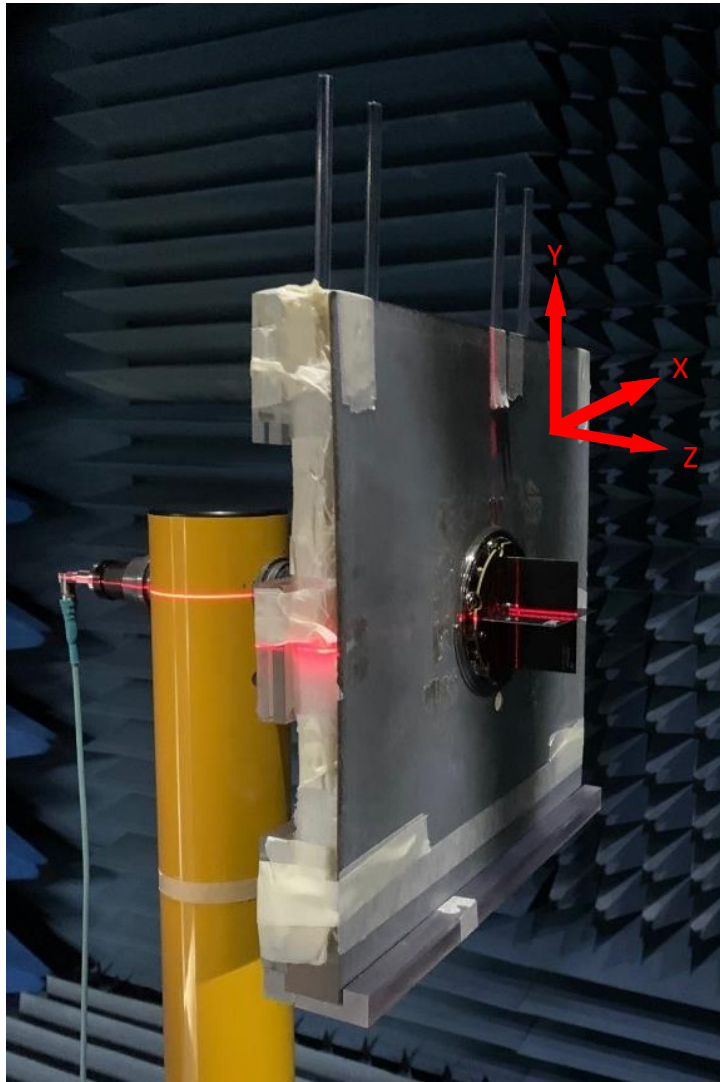

5.2 1176MHz 3D and 2D Radiation Patterns

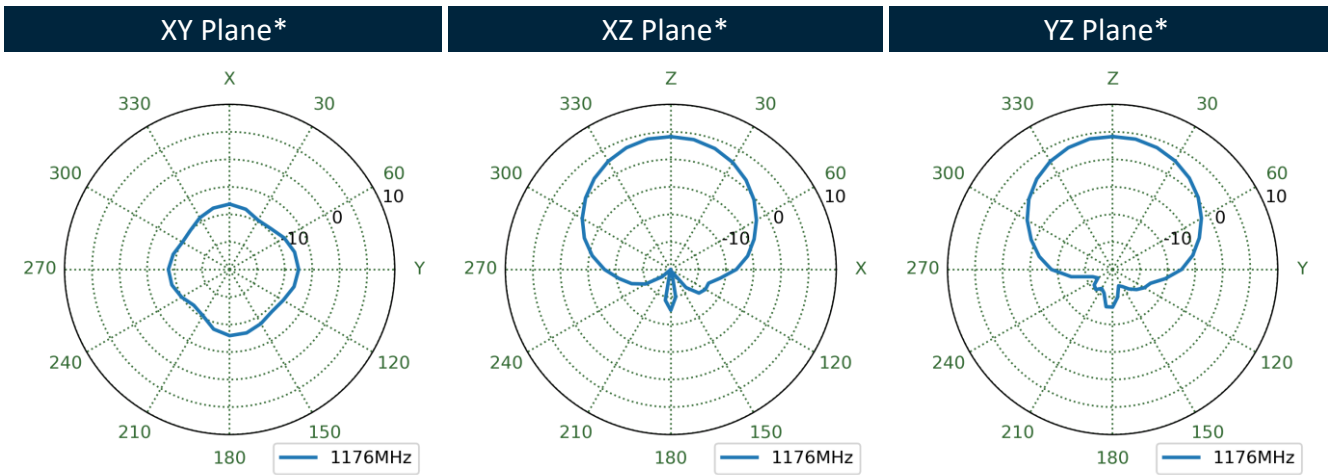
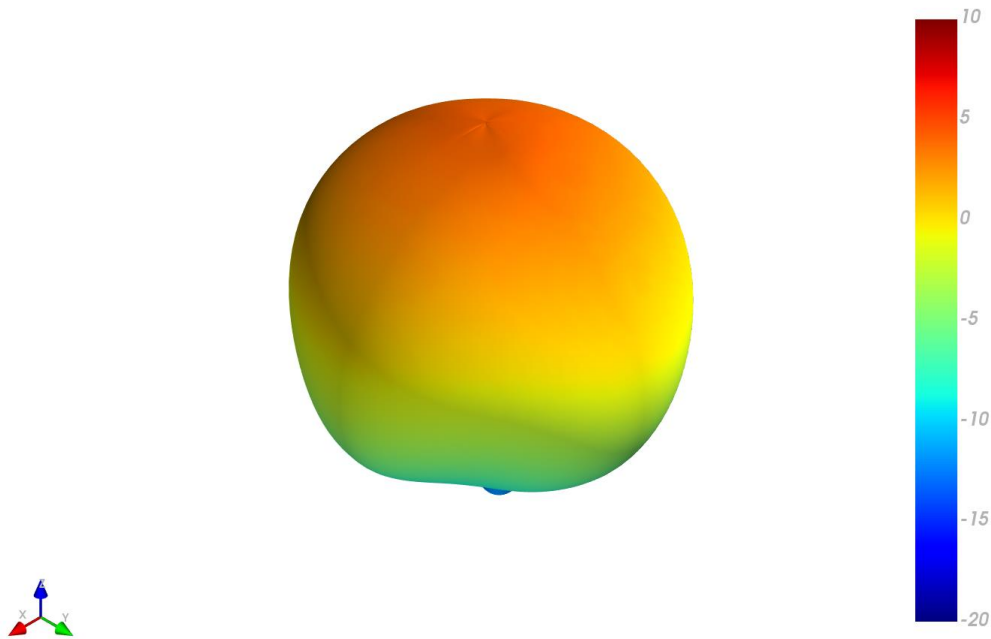

5.3 1227MHz 3D and 2D Radiation Patterns

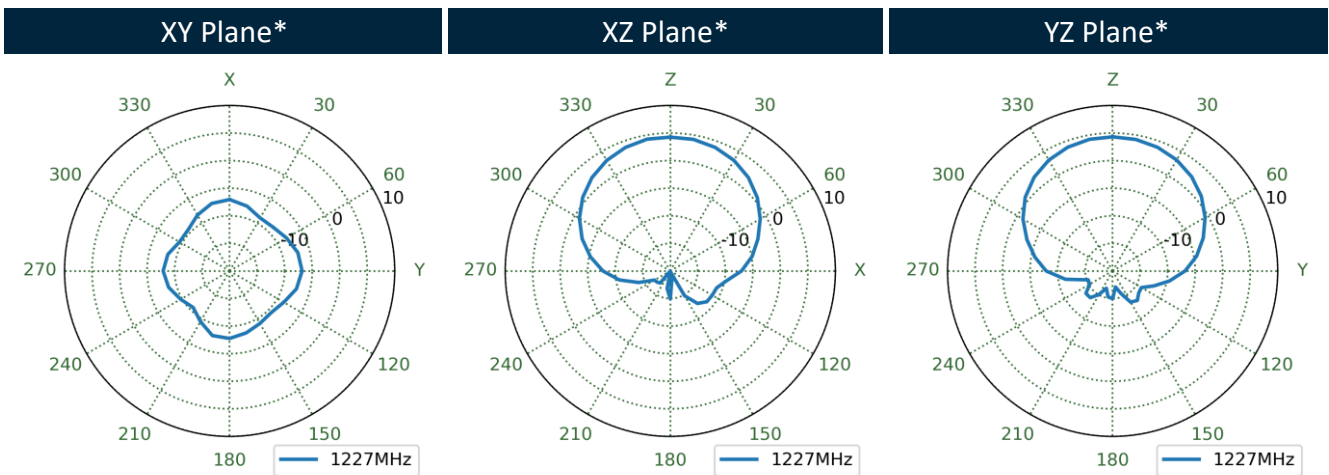
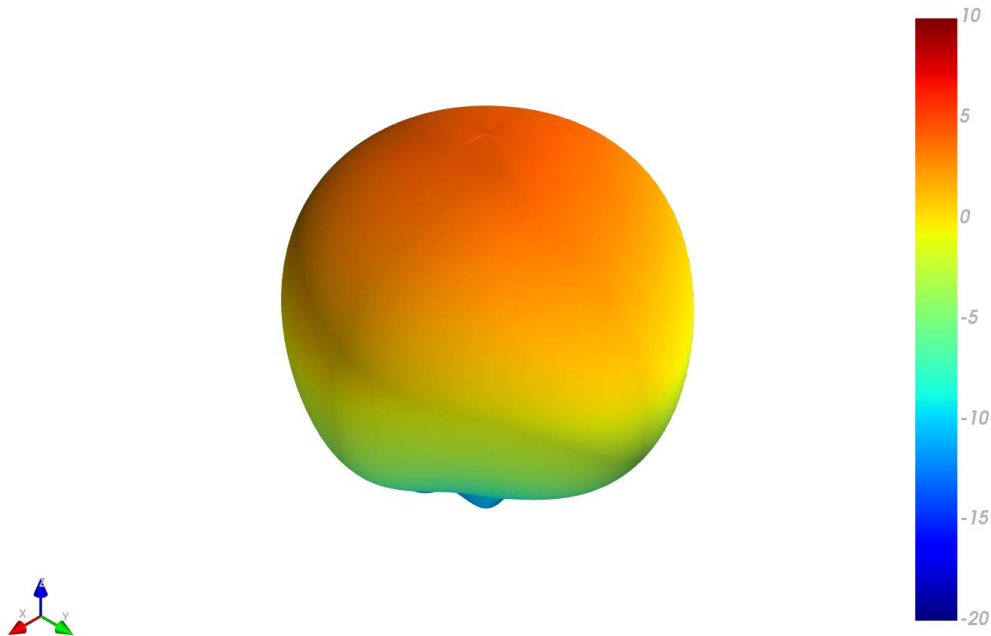



5.4 1278.75MHz 3D and 2D Radiation Patterns

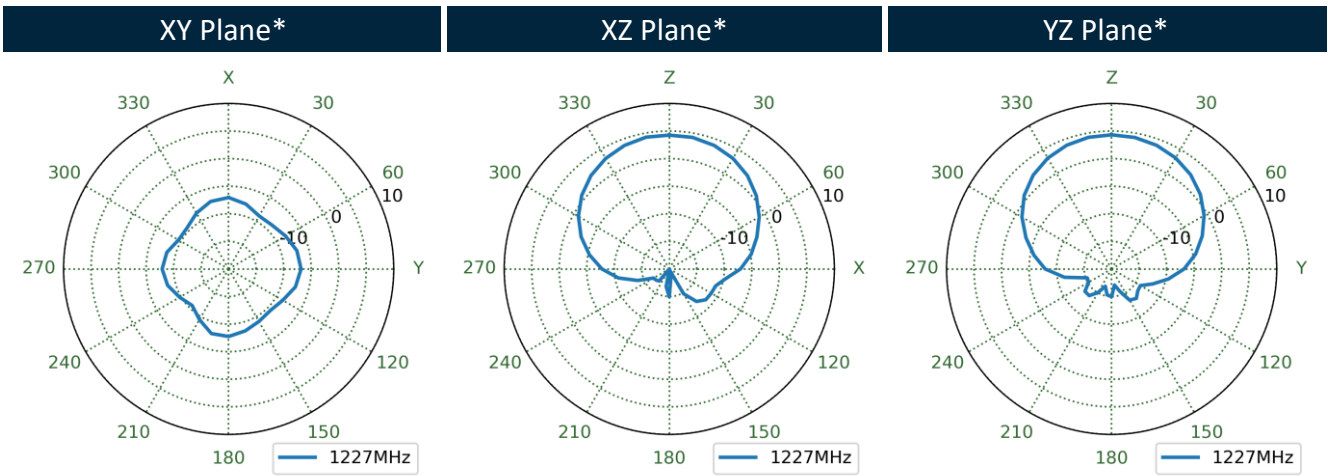
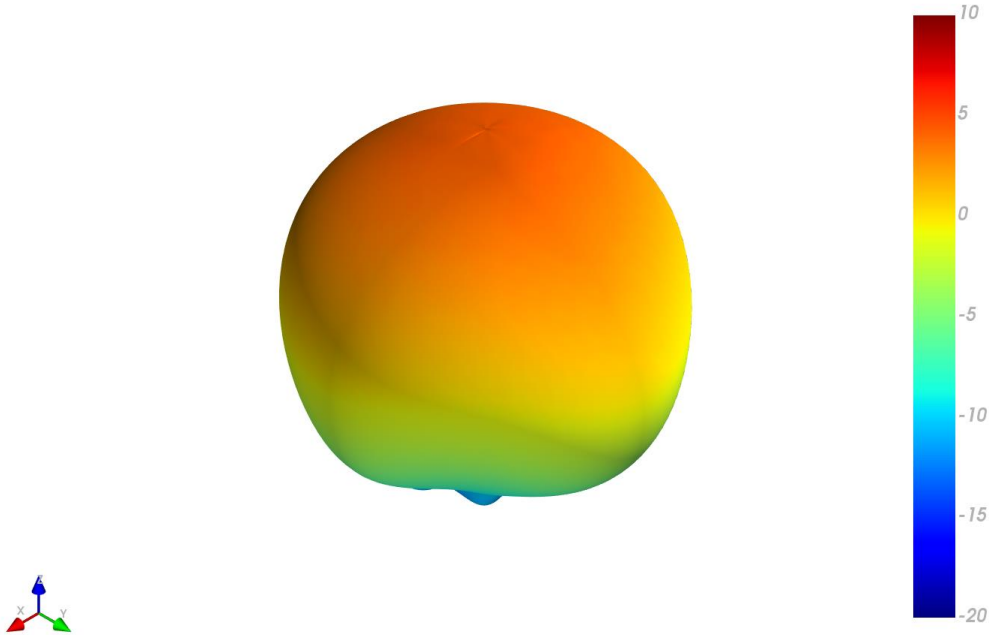

5.5 1561MHz 3D and 2D Radiation Patterns

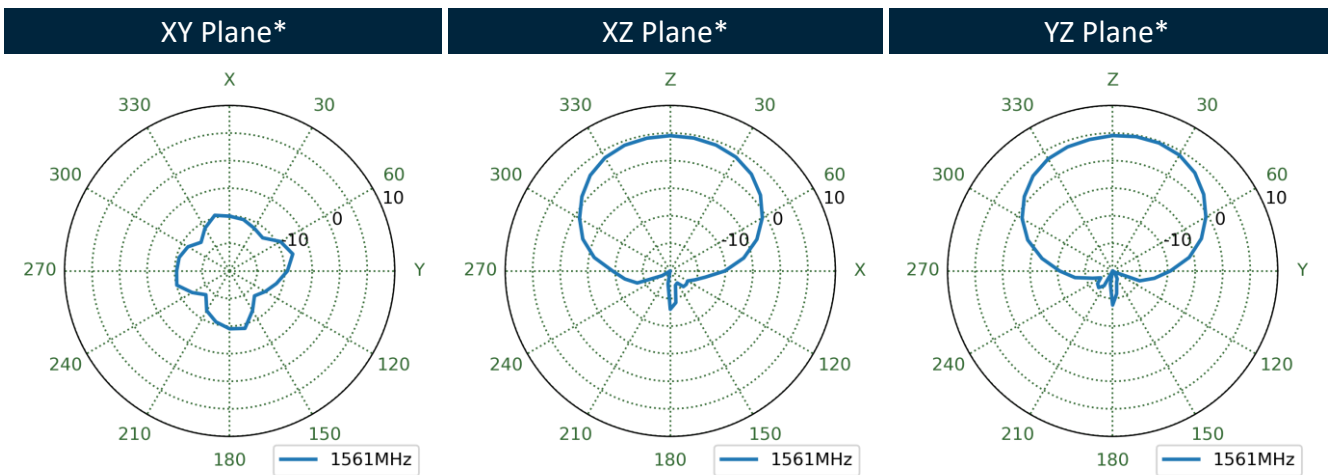
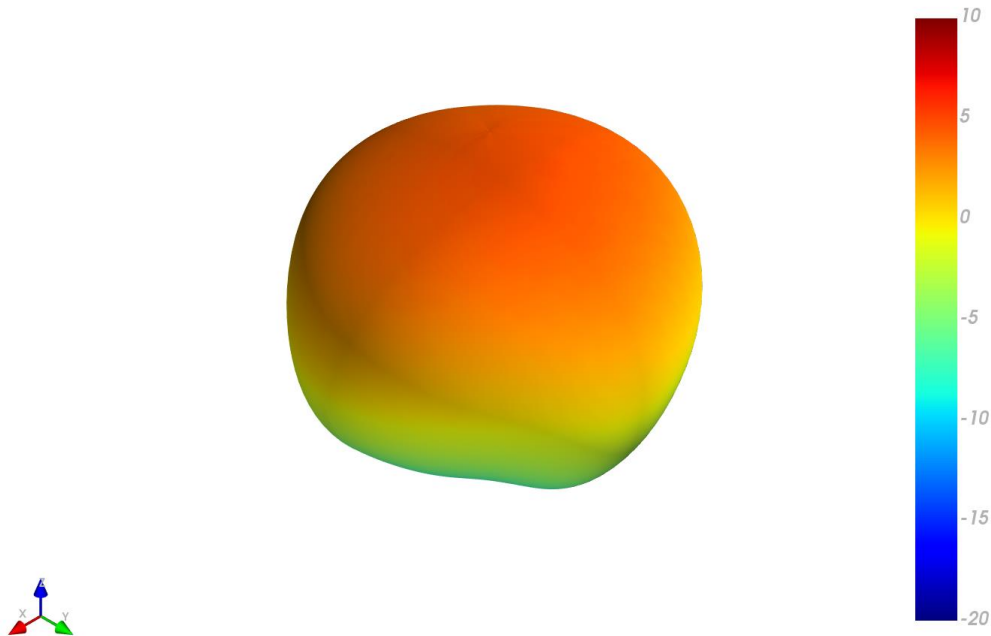

5.6 1575MHz 3D and 2D Radiation Patterns

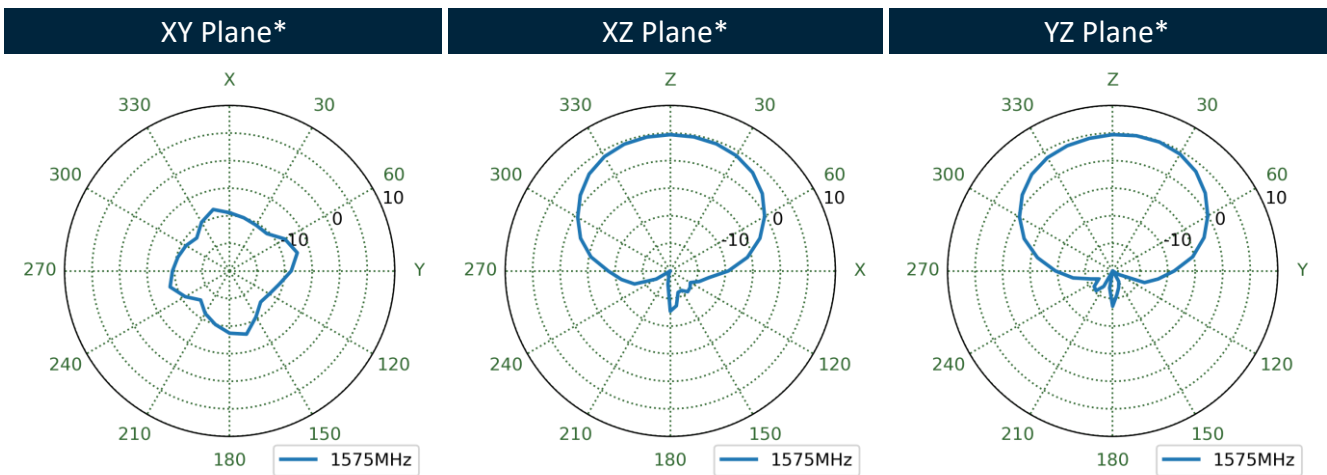
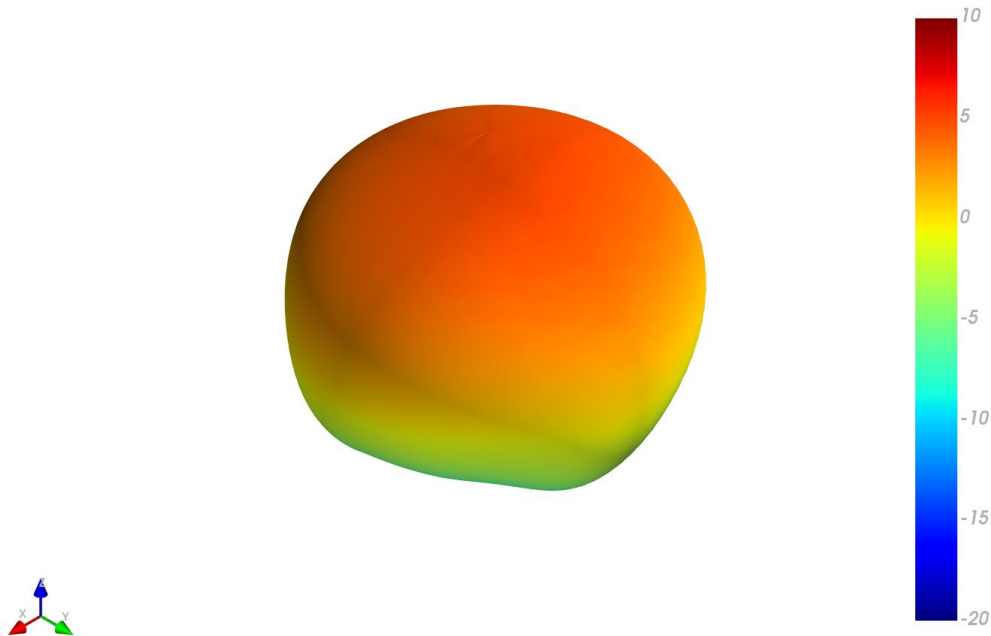

5.7 1602MHz 3D and 2D Radiation Patterns

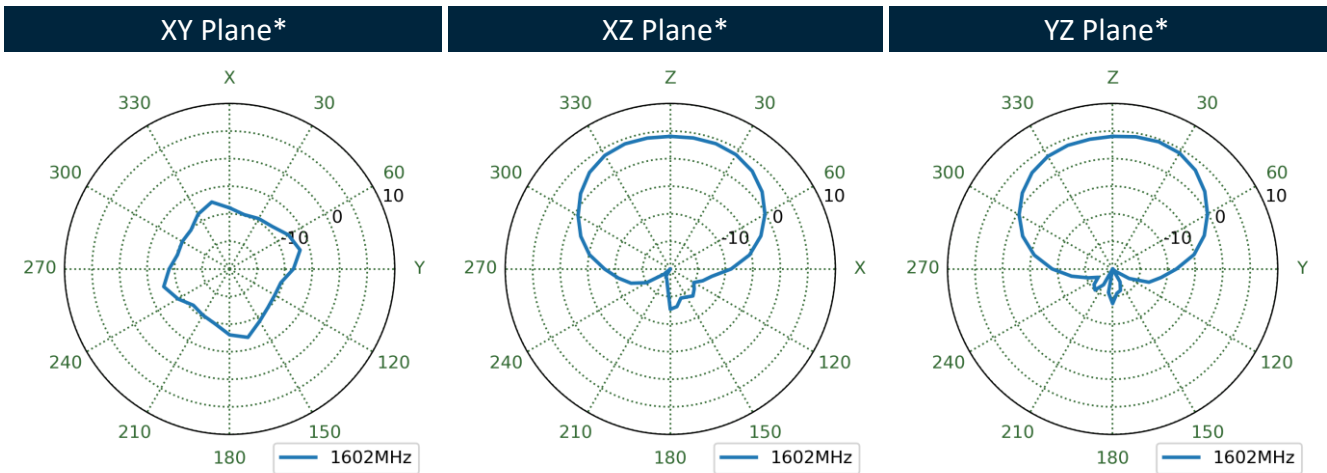
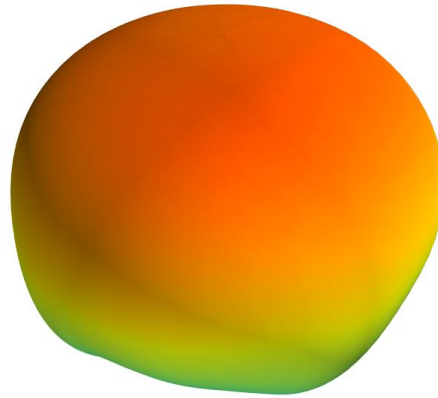

## 6. Field Test Results

In this section Taoglas will present the field test result for EAHP.50 antenna. The test was performed when the antenna was mounted on a static rooftop test set up in an open sky environment for at least **6 hours**.

Taoglas will show the field test results using the following receivers:

### 6.1 Ublox ZED-F9P

#### Receiver features:

- Multi-band GNSS: 184-channel GPS L1C/A L2C, GLONASS: L1OF L2OF, Galileo: E1B/C E5b, BeiDou: B1I B2I, QZSS: L1C/A L2C
- Multi-band RTK with fast convergence times and reliable performance
- Nav. update rate RTK up to 20 Hz
- Position accuracy = RTK 0.01 m + 1 ppm CEP

Positioning Accuracy Table (2D Accuracy)					
Test Condition	Correction Service	CEP (50%)	DRMS (68%)	2DRMS (95-98.2%)	TTF (sec)
Free Space	RTK DISABLED	47.08 cm	56.53 cm	113.06 cm	20
	RTK ENABLED	1.51 cm	1.83 cm	3.66 cm	20
30x30 cm Ground Plane	RTK DISABLED	46.69 cm	54.83 cm	110.65 cm	19
	RTK ENABLED	0.47 cm	0.57 cm	1.14 cm	19

RTK Availability  
Free space

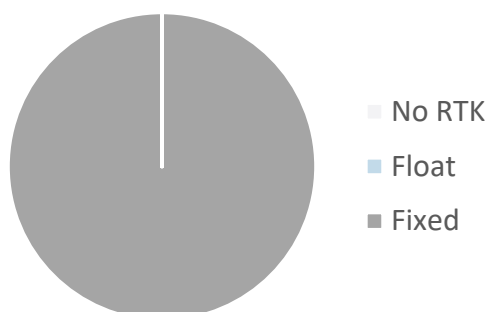

RTK Availability  
30x30 cm ground plane

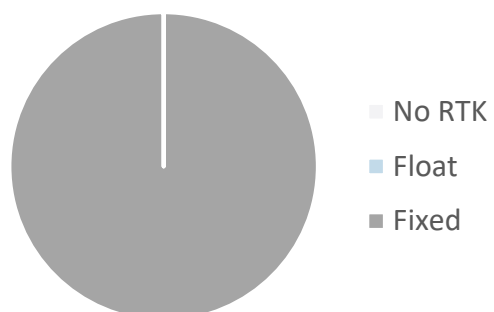

## 6.2 Septentrio AsteRx-U S/N

### Receiver features:

- Multi-band GNSS: 544 channels
- GPS: L1, L2, L5 GLONASS: L1, L2, L3 Galileo: E1, E5ab, AltBoc, E6 BeiDou: B1, B2, B3 NavIC: L51 QZSS: L1, L2, L5, L6
- SBAS: EGNOS, WAAS, GAGAN, MSAS, SDCM(L1, L5)
- RTK (base and rover), Integrated dual-channel L-band receiver, Support for PPP
- Nav. update rate up to 100 Hz
- Position accuracy = RTK 0.6 cm + 0.5 ppm

Positioning Accuracy Table (2D Accuracy)				
Test Condition	Correction Service	CEP (50%)	DRMS (68%)	2DRMS (95-98.2%)
Free Space	RTK DISABLED	39.22 cm	47.08 cm	94.17 cm
	RTK ENABLED	0.99 cm	1.2 cm	2.4 cm
30x30 cm Ground Plane	RTK DISABLED	37.08 cm	45.04 cm	90.08 cm
	RTK ENABLED	0.96 cm	1.16 cm	2.31 cm

RTK Availability  
Free space

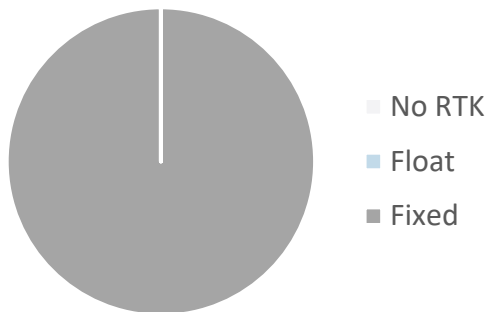

RTK Availability  
30x30 cm ground plane

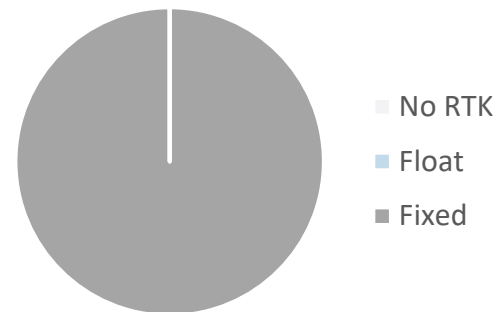

# 7. Mechanical Drawing (Units: mm)

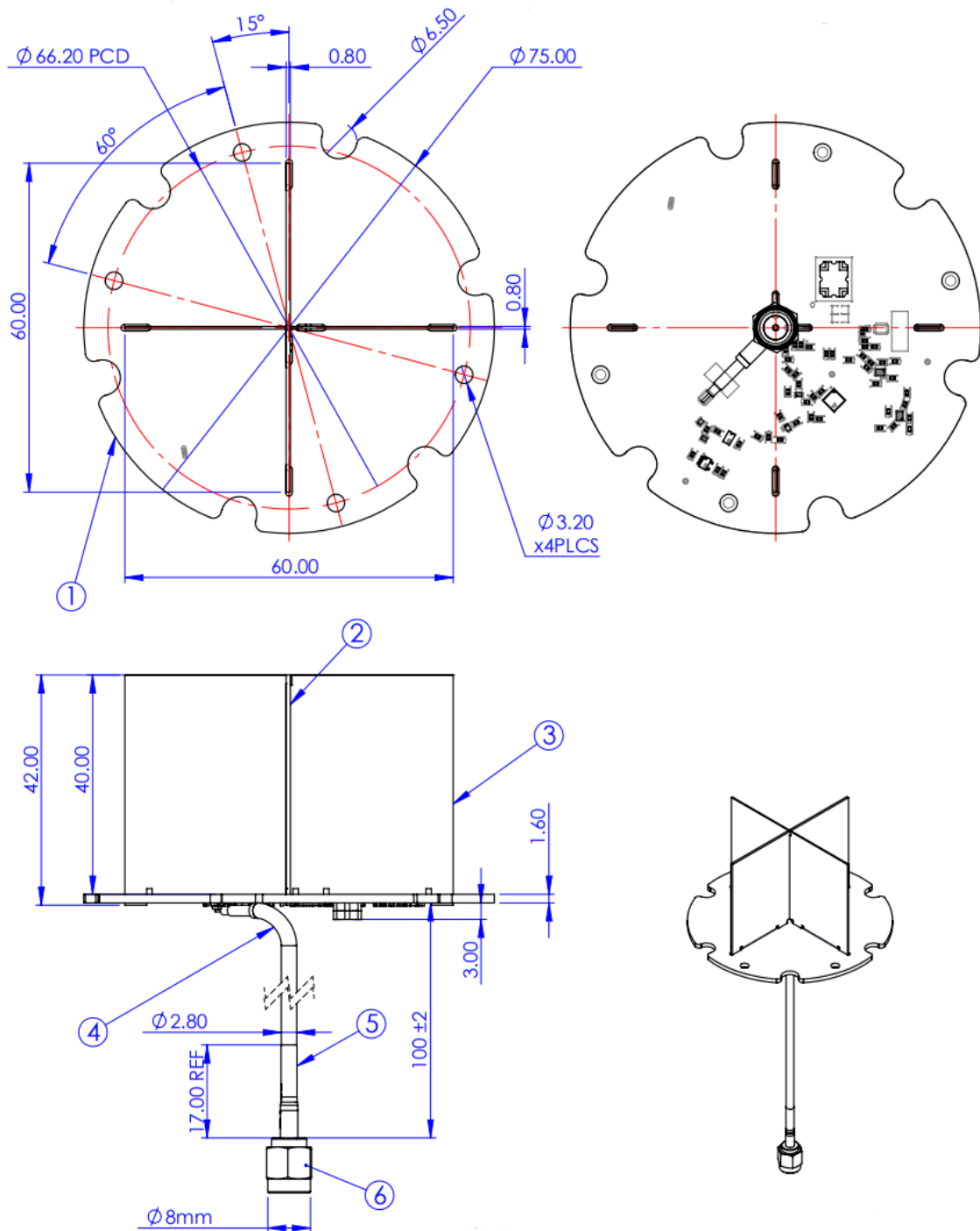

	Name	Material	Finish	QTY
1	EAHP.50 Feed PCB	NP175F	Black	1
2	EAHP.50.Passive Antenna A	IT180	Black	1
3	EAHP.50.Passive Antenna B	IT180	Black	1
4	RG-174 Coaxial Cable	PVC	Black	1
5	Heat Shrink Tube (GNSS)	PE	Blue tube/White Test	1
6	SMA(M)	Brass	Au Plated	1

## 7.1 Example Setup

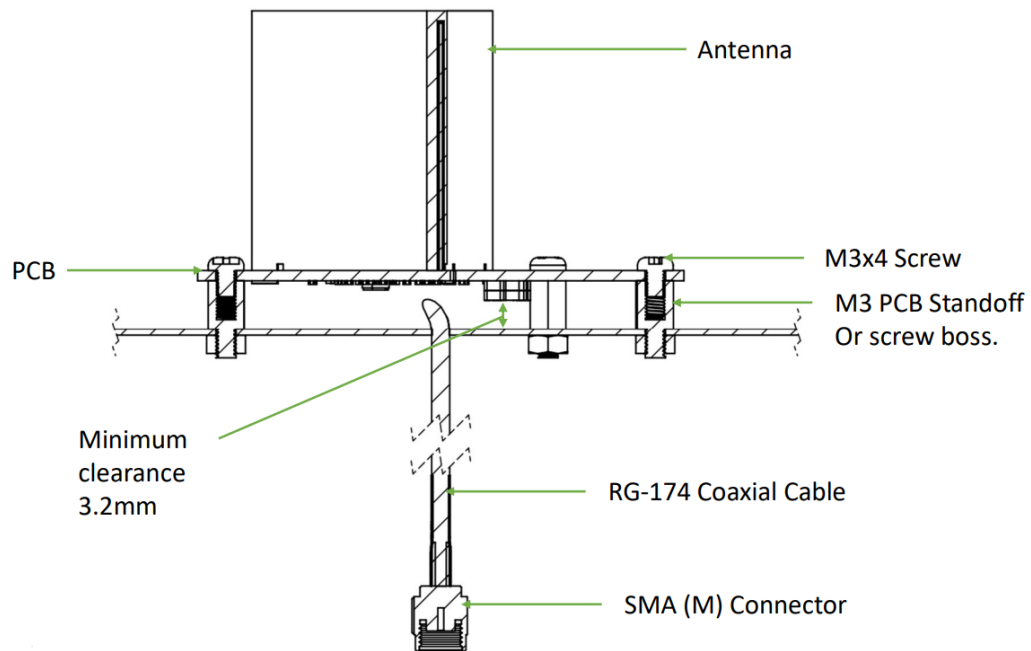

## 7.2 Screws

Install four M3 screws to secure antenna PCB to base as shown below.

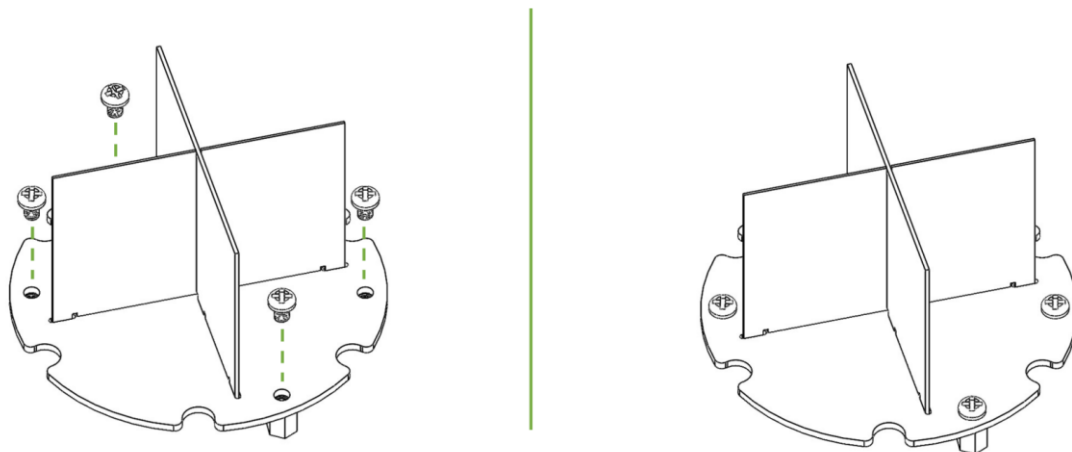



## 8. Packaging

1pc EAHP.50.01.0100D per PE Bag  
 Dimensions - 135\*130\*140mm  
 Weight - 31g

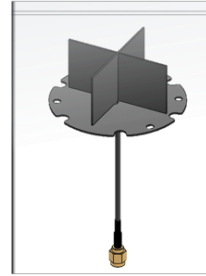

24pcs EAHP.50.A.301111 per Carton  
 Dimensions - 588\*296\*142mm  
 Weight - 1.5Kg

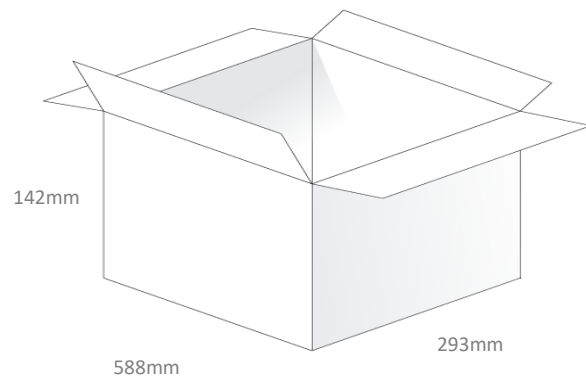

Changelog for the datasheet

**SPE-21-8-009 – EAHP.50.01.0100D**

**Revision: D (Current Version)**

Date:	2023-07-04
Changes:	Updated Drawing and example integration
Changes Made by:	Cesar Sousa

**Previous Revisions**

**Revision: C**

Date:	2023-02-21
Changes:	Updated GNSS Bands & Constellations Graphics
Changes Made by:	Cesar Sousa

**Revision: B**

Date:	2021-06-12
Changes:	Updated Image and Drawing
Changes Made by:	Jack Conroy

**Revision: A (Original First Release)**

Date:	2021-02-22
Notes:	Initial Release
Author:	Jack Conroy