

Technical Data Sheet

Opto Interrupter

EAITRCB0

Features

- Fast response time
- High analytic
- High sensitivity
- Cut-off visible wavelength $\lambda_P=940\text{nm}$
- Pb Free
- This product itself will remain within RoHS compliant version.

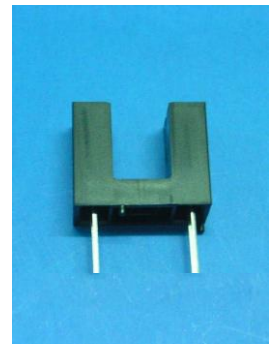

Description

The **EAITRCB0** consist of an infrared emitting diode and an NPN silicon phototransistor, encased side-by-side on converging optical axis in a black thermoplastic housing . The phototransistor receives radiation from the IR LED only .This is the normal situation. But when an object is between the IR and PT, phototransistor could not receive the radiation. For additional component information, please refer to IR908-7C-F and PT908-7C-F

Applications

- Mouse Copier
- Switch Scanner
- Floppy disk driver
- Non-contact Switching
- For Direct Board

Device Selection Guide

Device No.	Chip Material	LENS COLOR
IR	GaAlAs	Water clear
PT	Silicon	Water clear

Absolute Maximum Ratings (Ta=25°C)

Parameter		Symbol	Ratings	Unit
Input	Power Dissipation at(or below) 25°C Free Air Temperature	Pd	75	mW
	Reverse Voltage	V _R	5	V
	Forward Current	I _F	50	mA
	Peak Forward Current (*1) Pulse width ≤100μs, Duty cycle=1%	I _{FP}	1	A
Output	Collector Power Dissipation	P _C	75	mW
	Collector Current	I _C	20	mA
	Collector-Emitter Voltage	B V _{CEO}	30	V
	Emitter-Collector Voltage	B V _{ECO}	5	V
Operating Temperature		T _{opr}	-25~+85	°C
Storage Temperature		T _{stg}	-40~+100	°C
Lead Soldering Temperature (*2) (1/16 inch form body for 5 seconds)		T _{sol}	260	°C

Notes: (*1) $t_w=100 \mu\text{sec.}$, $T=10 \text{ msec.}$ (*2) $t=5 \text{ Sec}$

Electro-Optical Characteristics (Ta=25°C)

Parameter		Symbol	Min.	Typ.	Max.	Unit	Condition
Input	Forward Voltage	V_F	-	1.2	1.5	V	$I_F=20mA$
	Reverse Current	I_R	-	-	10	μA	$V_R=5V$
	Peak Wavelength	λ_P	-	940	-	nm	$I_F=20mA$
Output	Dark Current	I_{CEO}	-	-	100	nA	$V_{CE}=20V, E_e=0mW/cm^2$
	C-E Saturation Voltage	$V_{CE(sat)}$	-	-	0.4	V	$I_C=2mA, E_e=1mW/cm$
Collector Current (* 3)		$I_{C(ON)}$	0.9	-	-	mA	$V_{CE}=5V, I_F=20mA$
Response Time	Rise Time	t_R	-	15	-	μs	$V_{CE}=5V \quad I_C=1mA \quad R_L=1K\Omega$
	Fall Time	t_F	-	15	-	μs	

Typical Electrical/Optical/Characteristics Curves for IR

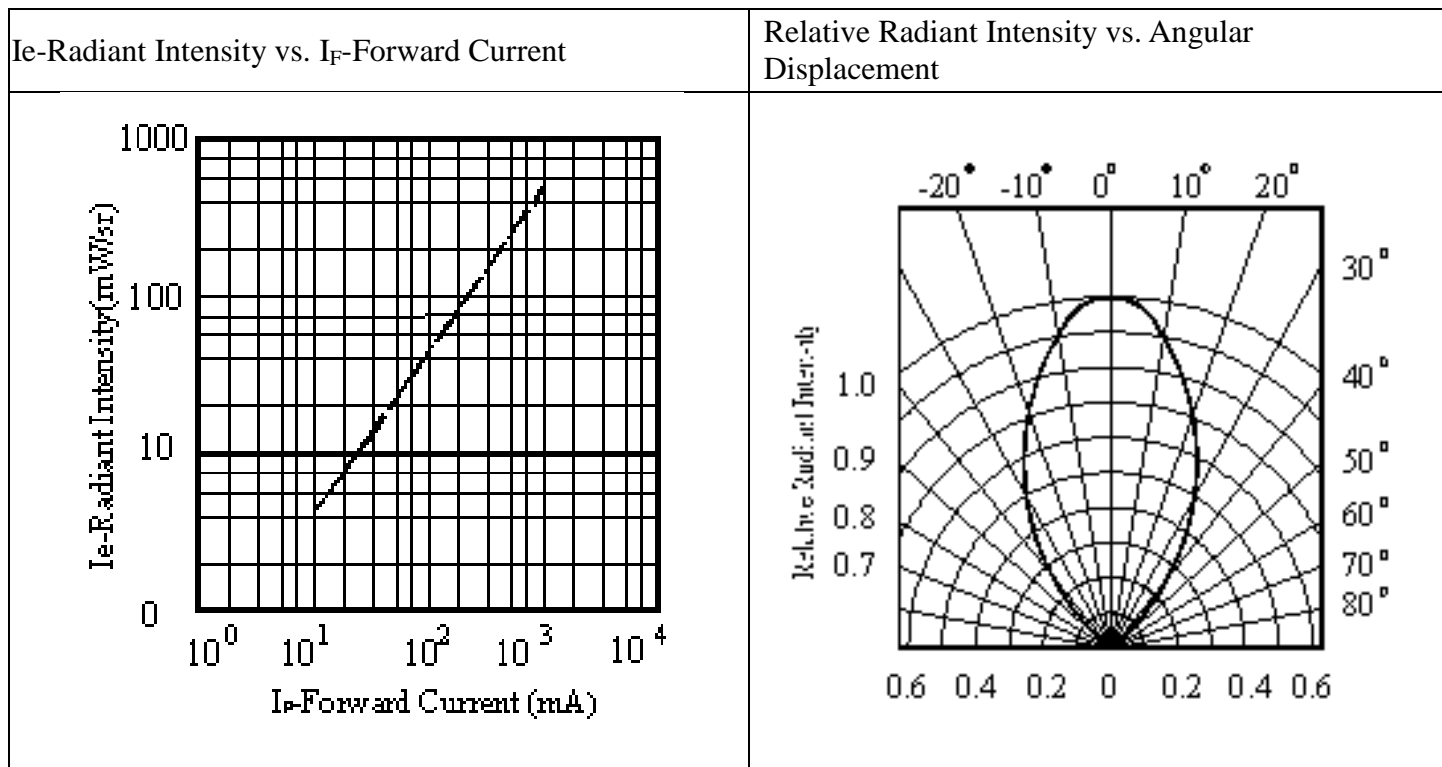
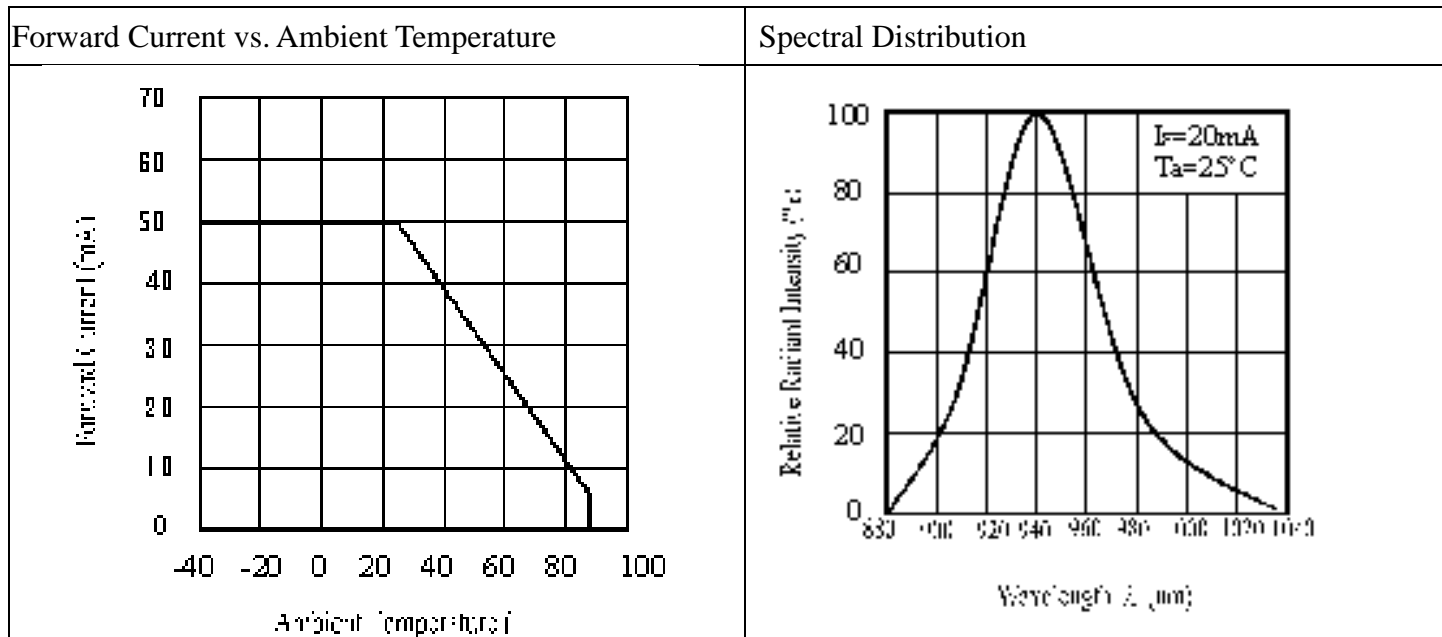

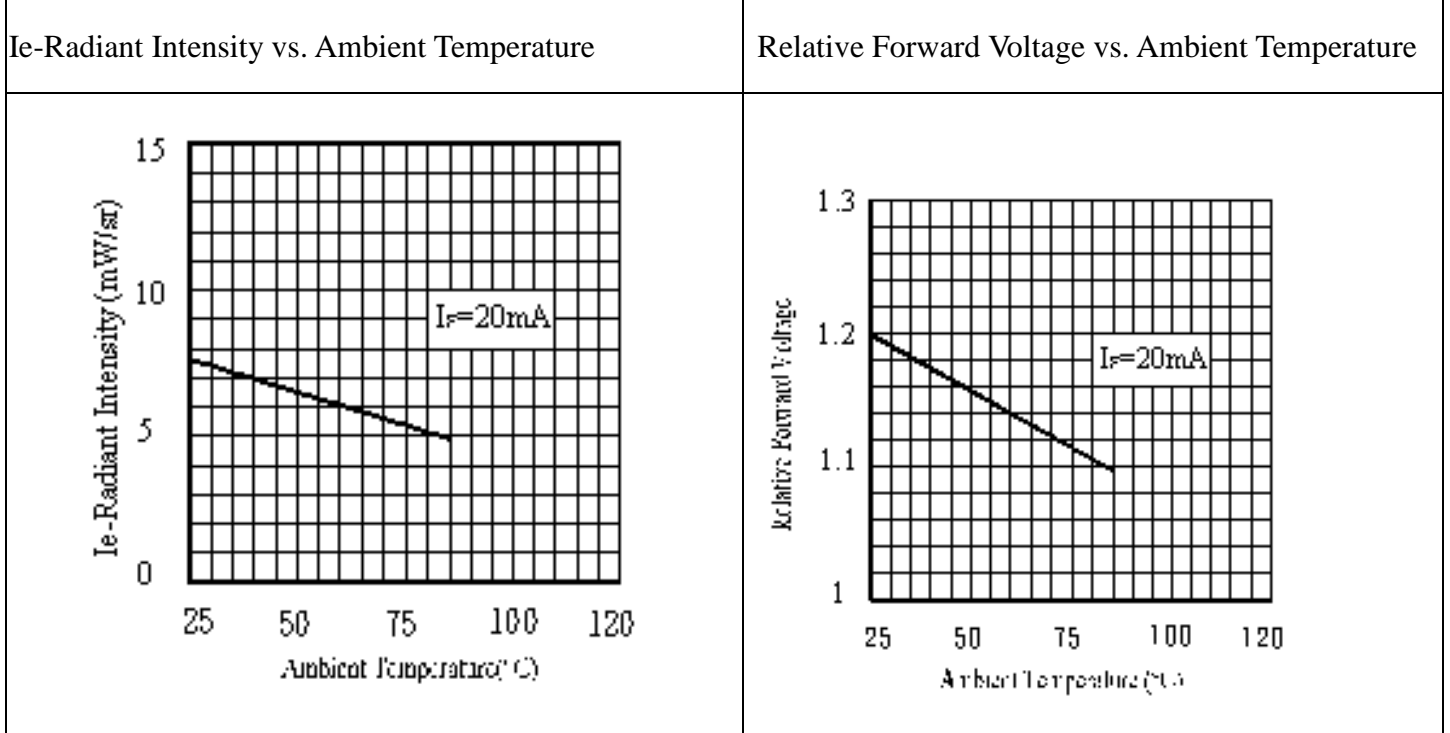

Typical Electro/Optical/Characteristics Curves for PT

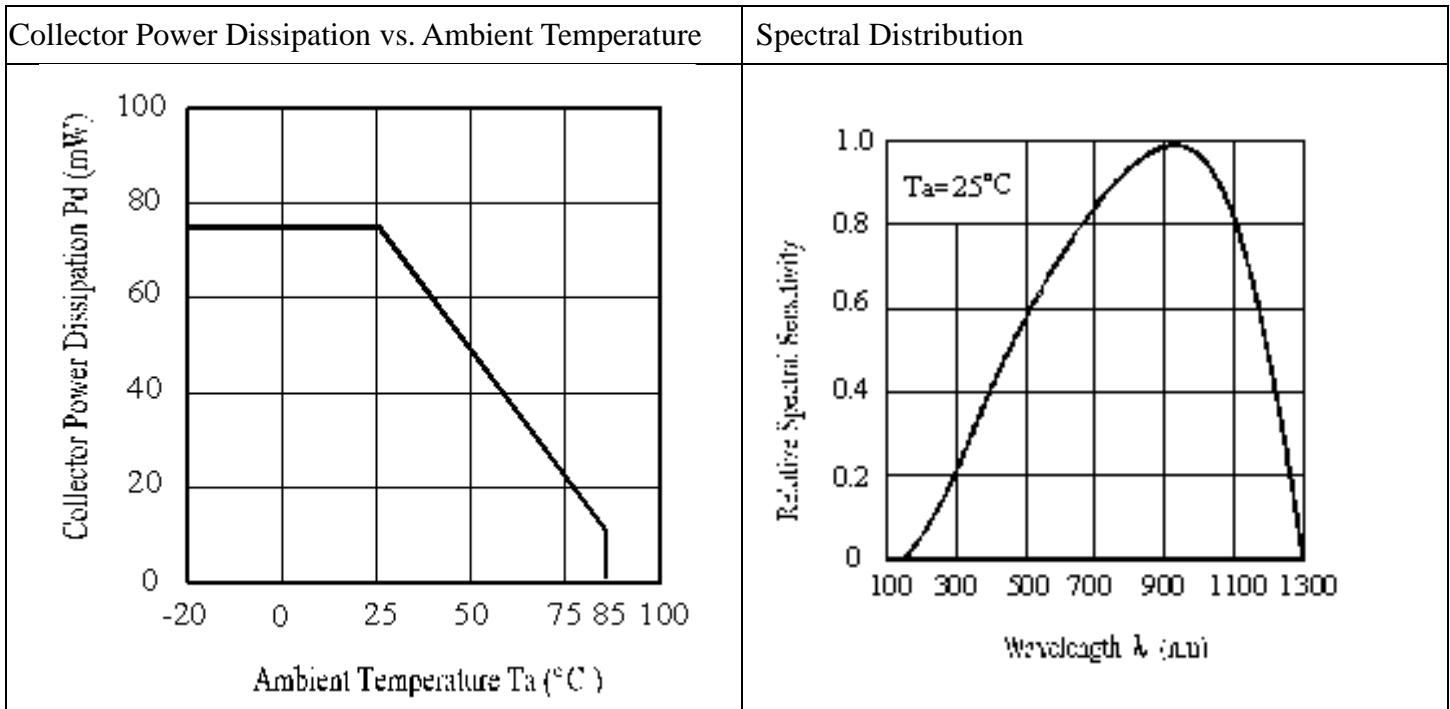

Relative Collector Current vs. Ambient Temperature

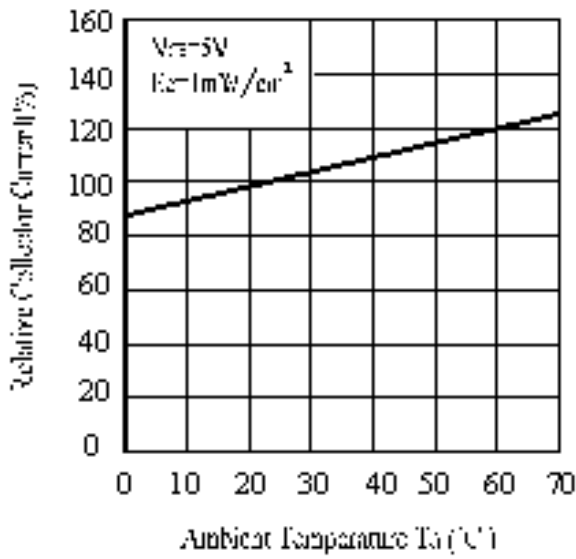

Collector Current vs. Irradiance

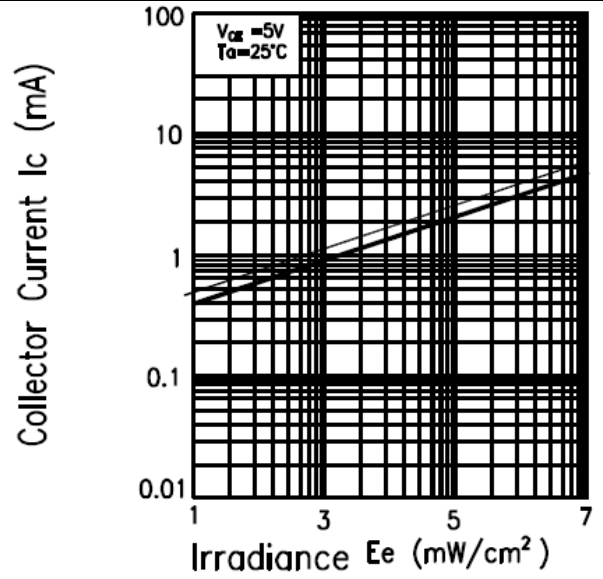

Collector Dark Current vs. Ambient Temperature

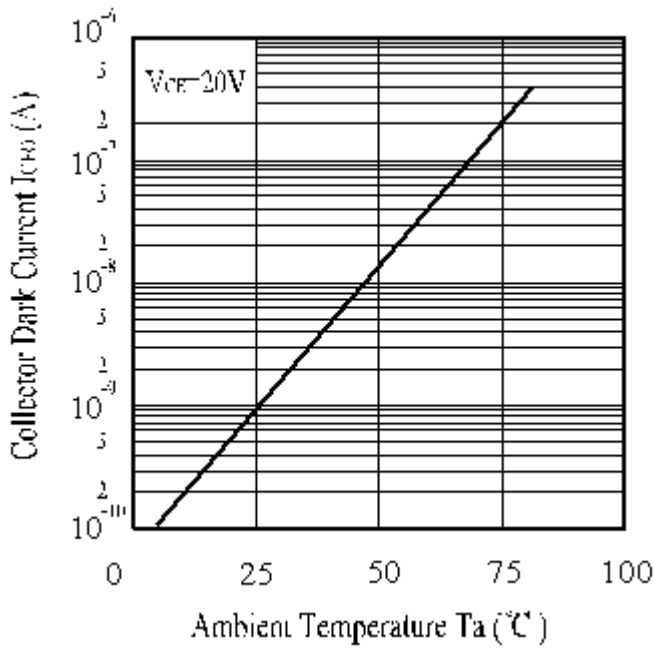

Collector Current vs. Collector-Emitter Voltage

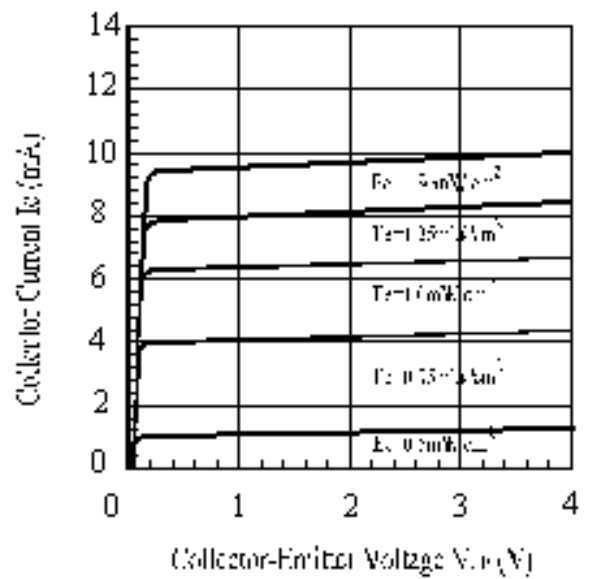

Reliability Test Item And Condition

The reliability of products shall be satisfied with items listed below.

Confidence level : 90%

LTPD : 10%

NO.	Item	Test Condition	Test Hours/ Cycle	Sample Size	Failure Judgement Criteria	Ac/Re
1	Solder Heat	TEMP : 260°C ± 5 °C	10 sec	22 PCs	Ic(on) ≤ L×0.8 L :Lower specification limit	0/1
2	Temperature Cycle	H : +100°C 15 mins ↑ 5 min ↓ L : -40°C 15 min	300 cycle	22 PCs		0/1
3	Thermal Shock	H : +100°C 5 min ↑ 10 sec ↓ L : -10°C 5 min	300 cycle	22 PCs		0/1
4	High Temperature Storage	TEMP. : +100°C	1000 hrs	22 PCs		0/1
5	Low Temperature Storage	TEMP. : -40°C	1000 hrs	22 PCs		0/1
6	DC Operating Life	V _{CE} =5V I _F =20mA	1000 hrs	22 PCs		0/1
7	High Temperature / High Humidity	85°C / 85% R.H.	1000 hrs	22 PCs		0/1

Package Dimension

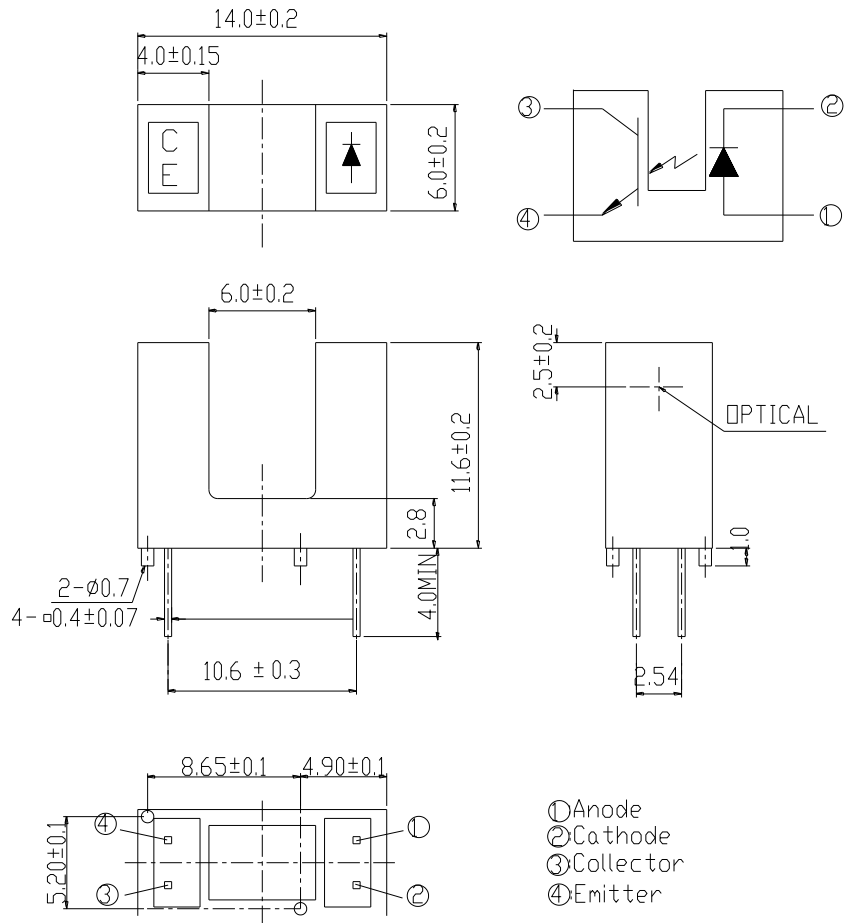

Notes:

1. All dimensions are in millimeters
2. Tolerances unless dimensions $\pm 0.2 \text{ mm}$