

Chip Photodiode with Right Angle Lens

EAPDSV3020A2

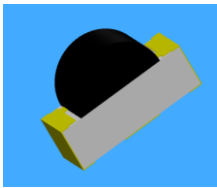

Features

- Fast response time
- High photo sensitivity
- Small junction capacitance
- Package in 8mm tape in “7” diameter reel
- Pb free
- The product itself will remain within RoHS compliant version.

Descriptions

- EAPDSV3020A2 is a high speed and high sensitive PIN photodiode in miniature flat top view lens SMD package and it is molded in a black plastic. The device is Spectrally matched to infrared emitting diode.

Applications

- High speed photo detector
- Copier
- Game machine

Device Selection Guide

Part Category	Chip Material	Lens Color
EAPDSV3020A2	Silicon	Black

Package Dimensions

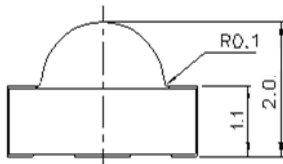
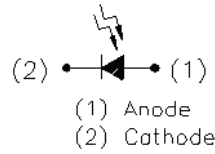
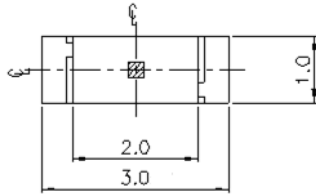

For reflow soldering (propose)

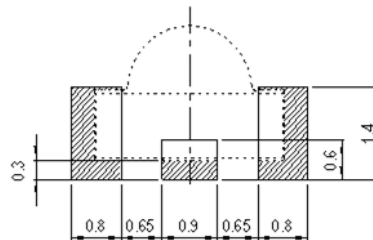
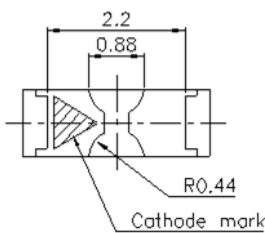

- Notes:** 1.All dimensions are in millimeters
 2.Tolerances unless dimensions ± 0.1 mm

Absolute Maximum Ratings ($T_a=25^\circ\text{C}$)

Parameter	Symbol	Rating	Unit
Reverse Voltage	V_R	32	V
Operating Temperature	T_{opr}	-25 ~ +85	$^\circ\text{C}$
Storage Temperature	T_{stg}	-40 ~ +100	$^\circ\text{C}$
Soldering Temperature *1	T_{sol}	260	$^\circ\text{C}$
Power Dissipation at(or below) 25 $^\circ\text{C}$ Free Air Temperature	P_c	150	mW

Notes: *1:Soldering time ≤ 5 seconds.

Electro-Optical Characteristics (Ta=25°C)

Parameter	Symbol	Condition	Min	Typ	Max	Unit
Range Of Spectral Bandwidth	$\lambda_{0.5}$	---	730	---	1100	nm
Wavelength Of Peak Sensitivity	λ_p	---	---	940	---	nm
Open-Circuit Voltage	V_{OC}	$E_e=1mW/cm^2$ $\lambda_p=875nm$	---	0.42	---	V
Short-Circuit Current	I_{SC}	$E_e=1mW/cm^2$ $\lambda_p=875nm$	---	1.3	---	μA
Reverse Light Current	I_L	$E_e=1mW/cm^2$ $\lambda_p=875nm$ $V_R=5V$	1.3	1.5	---	μA
Dark Current	I_D	$E_e=0mW/cm^2$ $V_R=10V$	---	---	10	nA
Reverse Breakdown Voltage	V_{BR}	$E_e=0mW/cm^2$ $I_R=100\mu A$	33	170	---	V
Total Capacitance	C_t	$E_e=0mW/cm^2$ $f=1MHz$ $V_R=5V$	---	2	---	pF
Rise Time	t_r	$V_R=5V$ $R_L=1000\Omega$	---	6	---	ns
Fall Time	t_f		---	6	---	
View Angle	2 θ 1/2	$V_R=5V(X)$	---	130	---	deg
		$V_R=5V(Y)$	---	130	---	

Typical Electro-Optical Characteristics Curves

Fig.1 Power Dissipation vs. Ambient Temperature

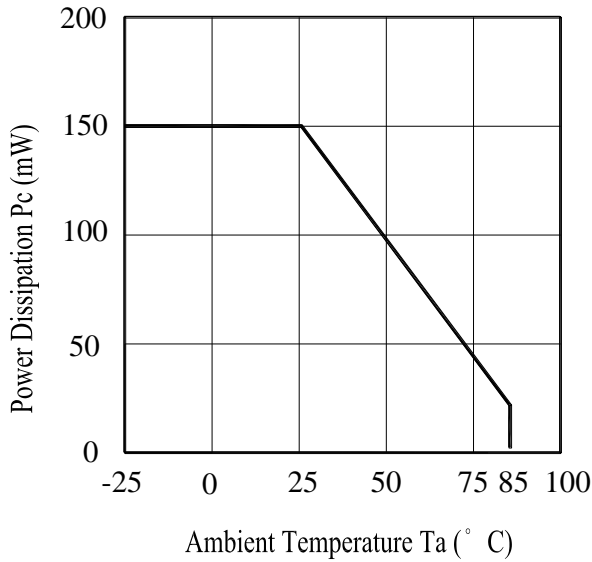

Fig.2 Spectral Sensitivity

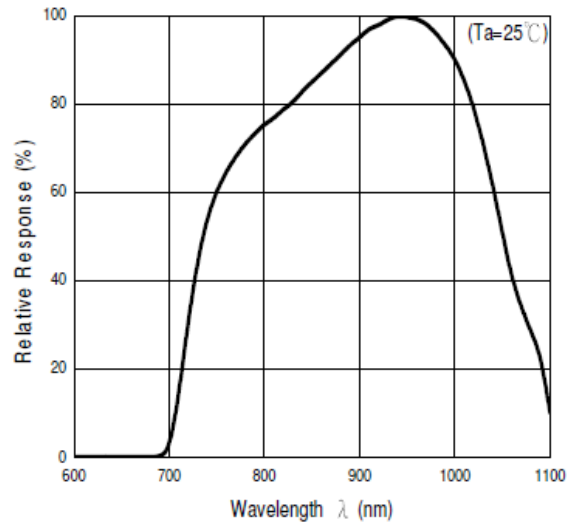

Fig.3 Dark Current vs. Ambient Temperature

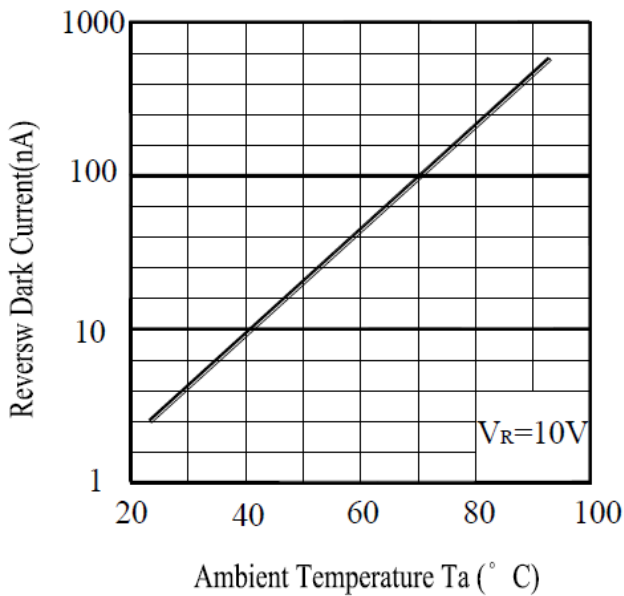
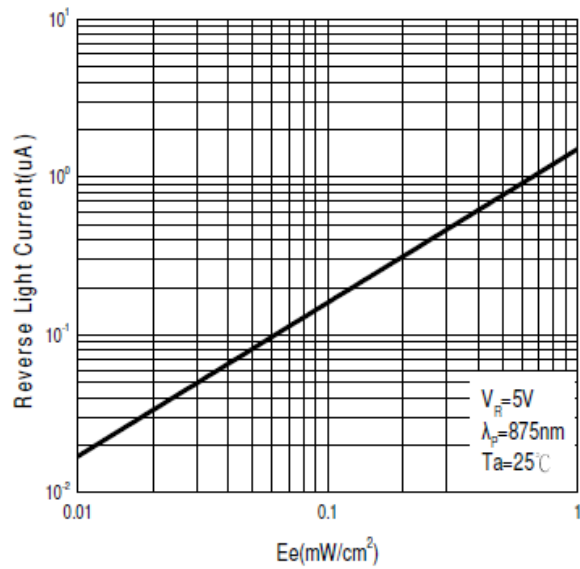

Fig.4 Collector Current vs. E_e



Typical Electro-Optical Characteristics Curves

Fig.5 Terminal Capacitance vs.

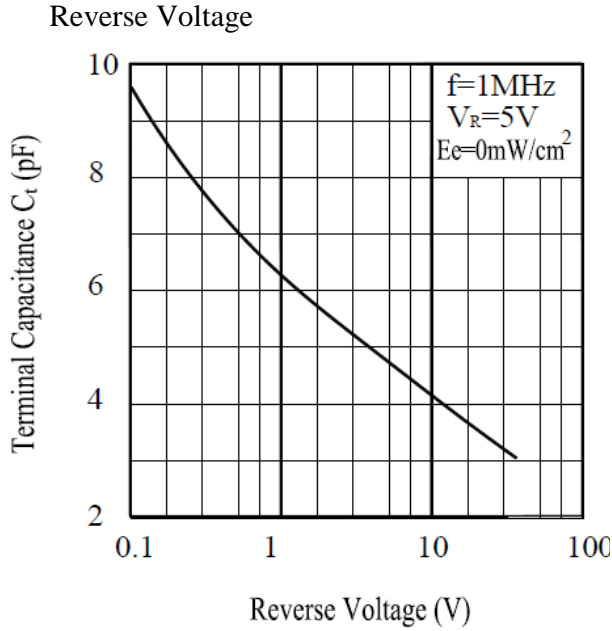

Fig.6 Response Time vs.

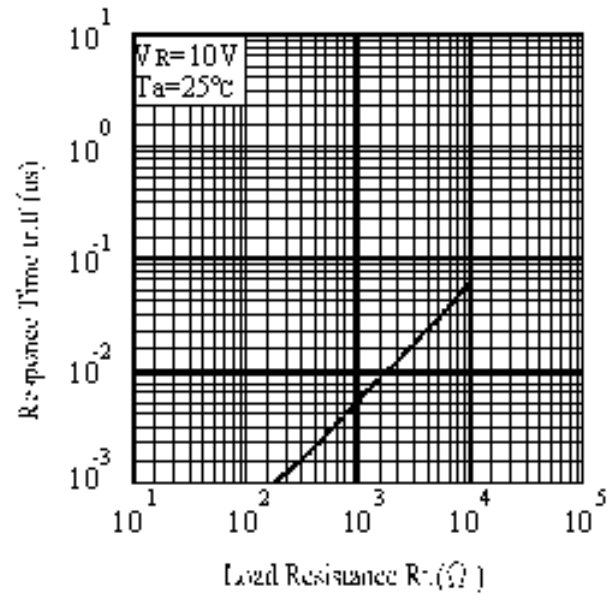
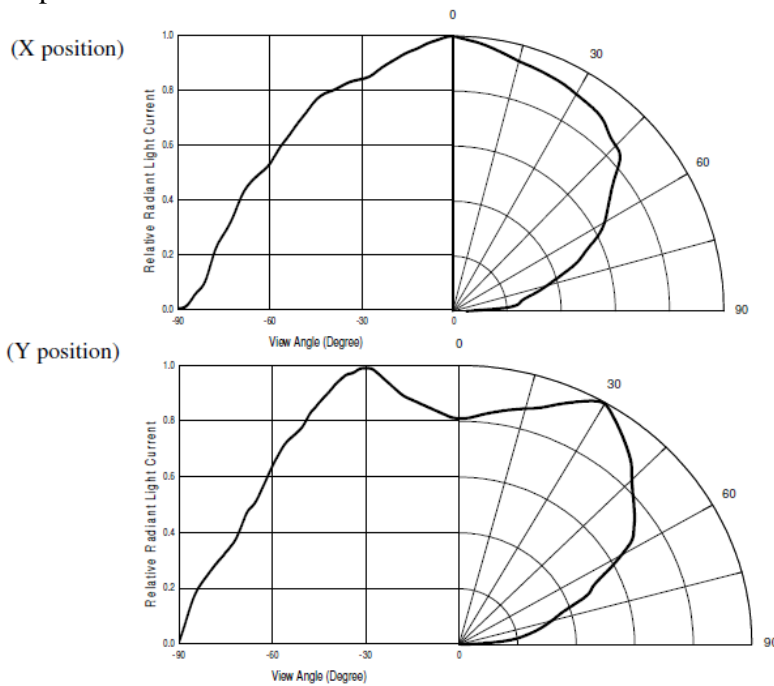

Fig.7 Relative Light Current vs.

Angular Displacement



Precautions For Use

1. Over-current-proof

Customer must apply resistors for protection, otherwise slight voltage shift will cause big current change (Burn out will happen).

2. Storage

2.1 Do not open moisture proof bag before the products are ready to use.

2.2 Before opening the package: The LEDs should be kept at 30°C or less and 90%RH or less.

2.3 The LEDs should be used within a year.

2.4 After opening the package, the LEDs should be kept at 30°C or less and 60%RH or less.

2.5 The LEDs should be used within 168 hours (7 days) after opening the package.

2.6 If the moisture absorbent material (silica gel) has faded away or the LEDs have exceeded the storage time, baking treatment should be performed using the following conditions.

Baking treatment : 60±5°C for 48 hours.

3. Soldering Condition

3.1 Pb-free solder temperature profile

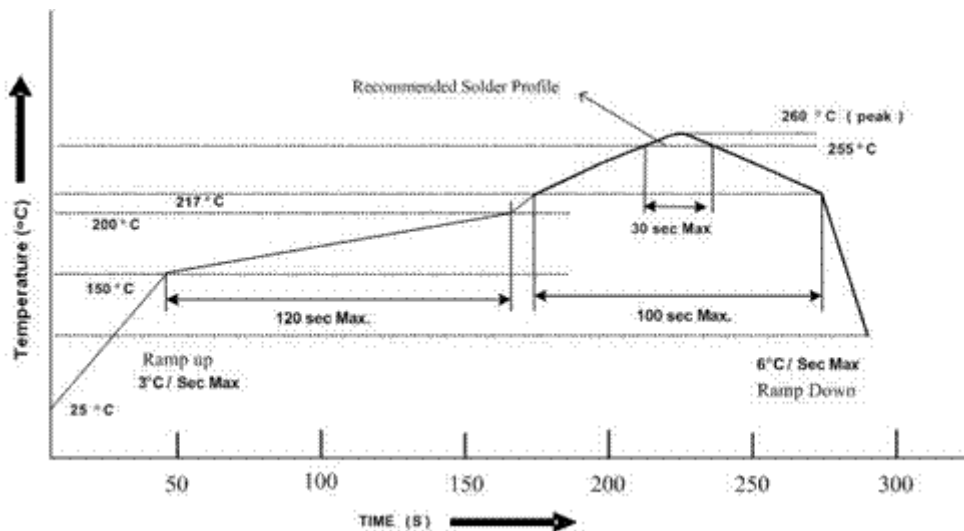

3.2 Reflow soldering should not be done more than two times.

3.3 When soldering, do not put stress on the LEDs during heating.

3.4 After soldering, do not warp the circuit board.

4. Soldering Iron

Each terminal is to go to the tip of soldering iron temperature less than 350°C for 3 seconds within once in less than the soldering iron capacity 25W. Leave two seconds and more intervals, and do soldering of each terminal. Be careful because the damage of the product is often started at the time of the hand solder.

5. Repairing

Repair should not be done after the LEDs have been soldered. When repairing is unavoidable, a double-head soldering iron should be used (as below figure). It should be confirmed beforehand whether the characteristics of the LEDs will or will not be damaged by repairing.

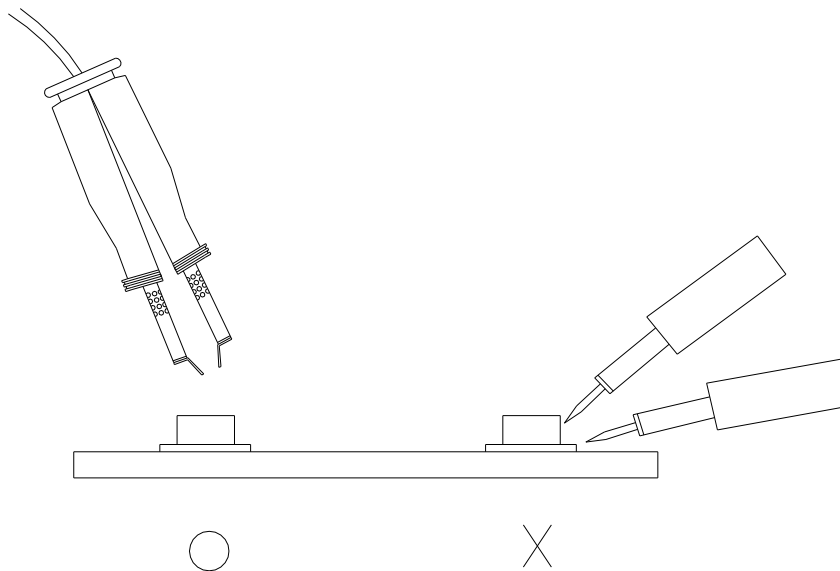

Package Dimensions

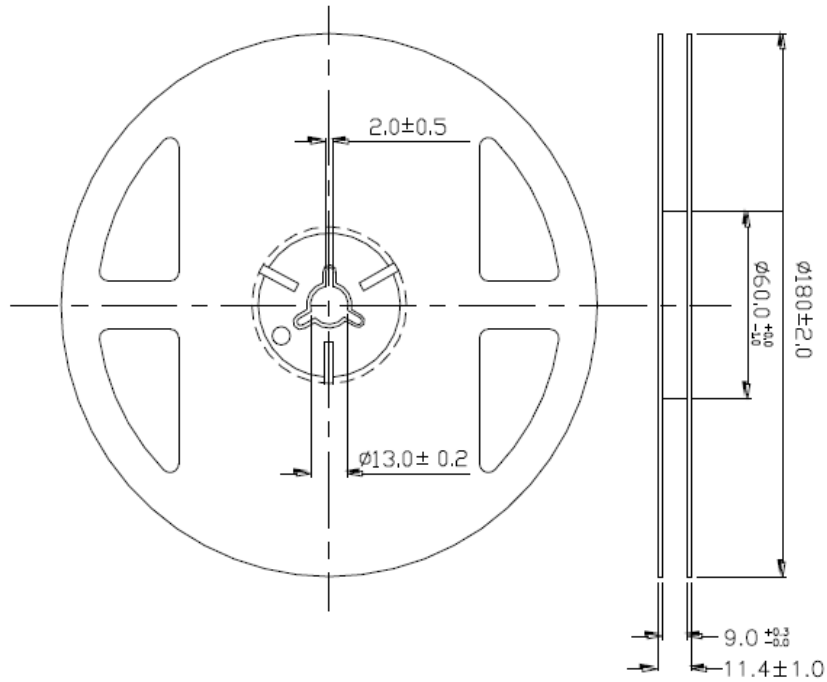

Carrier Tape Dimensions: Loaded quantity 2000 PCS per reel :

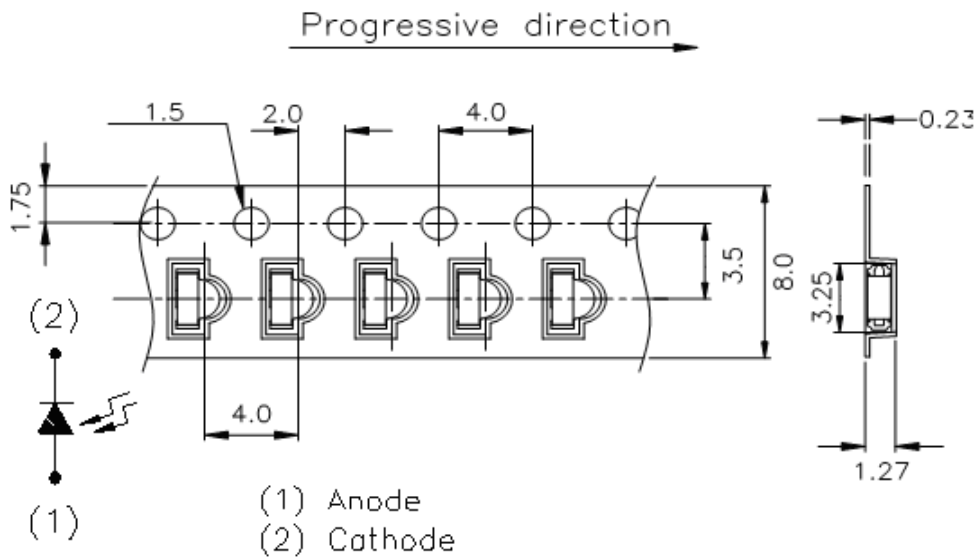

Unit:mm