

ignion 

Your innovation.  
Accelerated.

# COMPACT DUAL- BAND REACH Xtend™ (NN01-004)

USER MANUAL  
COMPACT DUAL-BAND REACH Xtend™ (NN01-004)

## Compact Dual-band Reach Xtend<sup>™</sup> (NN01-004) – 2.4-2.5 GHz and 4.9-5.875 GHz

Ignion specializes in enabling effective mobile communications. Using Ignion technology, we design and manufacture optimized antennas to make your wireless devices more competitive. Our mission is to help our clients develop innovative products and accelerate their time to market through our expertise in antenna design, testing and manufacturing.

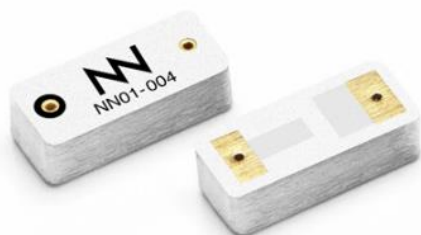

Compact Dual-band Reach Xtend<sup>™</sup>

NN01-004

Ignion products are protected by [Ignion patents](#).

All information contained within this document is property of Ignion and is subject to change without prior notice. Information is provided “as is” and without warranties. It is prohibited to copy or reproduce this information without prior approval.

Ignion is an ISO 9001:2015 certified company. All our antennas are lead-free and RoHS compliant.

ISO 9001:2015 Certified



## INDEX OF CHAPTERS

<b>1. ANTENNA DESCRIPTION</b>	<b>5</b>
<b>2. QUICK REFERENCE GUIDE</b>	<b>6</b>
<b>3. ELECTRICAL PERFORMANCE</b>	<b>6</b>
<b>4. MECHANICAL CHARACTERISTICS</b>	<b>10</b>
<b>5. ASSEMBLY PROCESS</b>	<b>11</b>
<b>6. PACKAGING</b>	<b>13</b>
<b>7. PRODUCT CHANGE NOTIFICATION</b>	<b>15</b>

## TABLE OF CONTENTS

<b>1. ANTENNA DESCRIPTION</b>	<b>5</b>
<b>2. QUICK REFERENCE GUIDE</b>	<b>6</b>
<b>3. ELECTRICAL PERFORMANCE</b>	<b>6</b>
<b>3.1. EVALUATION BOARD</b>	<b>6</b>
<b>3.2. MATCHING NETWORK</b>	<b>7</b>
<b>3.3. VSWR AND EFFICIENCY</b>	<b>7</b>
<b>3.4. RADIATION PATTERNS, GAIN AND EFFICIENCY</b>	<b>8</b>
<b>3.5. CAPABILITIES AND MEASUREMENT SYSTEMS</b>	<b>9</b>
<b>4. MECHANICAL CHARACTERISTICS</b>	<b>10</b>
<b>4.1. DIMENSIONS AND TOLERANCES</b>	<b>10</b>
<b>4.2. SPECIFICATIONS FOR THE INK</b>	<b>10</b>
<b>4.3. ANTENNA FOOTPRINT</b>	<b>11</b>
<b>5. ASSEMBLY PROCESS</b>	<b>11</b>
<b>6. PACKAGING</b>	<b>13</b>
<b>7. PRODUCT CHANGE NOTIFICATION</b>	<b>15</b>

# 1. ANTENNA DESCRIPTION

The Compact Dual-band Reach Xtend<sup>™</sup> chip antenna is engineered specifically for high performance dual-band WLAN devices operating at both 2.4 – 2.5 GHz and 4.9 – 5.875 GHz and using 802.11 ac/a/b/g/n systems. Compact Dual-band Reach Xtend<sup>™</sup> combines small size with high performance to improve the functionality of your wireless devices. Its small dimensions allow various configurations within the USB devices and may help Card-bus devices in the enhancement of their throughput by using MIMO algorithms with more than 2 antennas.

The Compact Dual-band Reach Xtend<sup>™</sup> chip antenna uses space-filling properties of Ignion technology to minimize its size while maintaining a high radiation efficiency value. This directly impacts antenna reliability in achieving a greater communication range (distance) and in improving battery life. Compact Dual-band Reach Xtend<sup>™</sup> features an omnidirectional radiation pattern optimal for highly scattered environments such as indoor environments and public spaces. Moreover, its broad bandwidth gives you design flexibility to create robust designs that operate at all global WLAN standards.

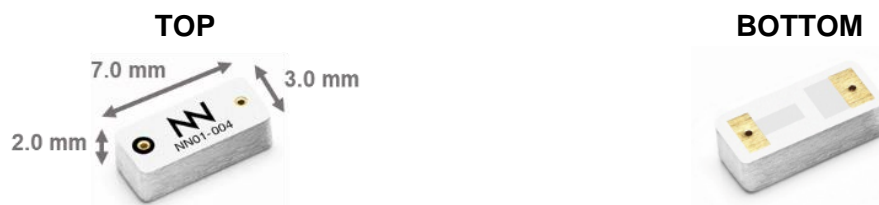

**Material:** The Compact Dual-band Xtend<sup>™</sup> antenna is built on glass epoxy substrate.

## APPLICATIONS

- Headsets
- Wireless Phone
- Modules WLAN 802.11 ac/a/b/g/n
- USB Dongles
- Sensors (Thickness measurement...)

## BENEFITS

- High efficiency and gain
- Small footprint
- Cost-effective
- Multiband behaviour. Worldwide standard compatible
- Easy to use (pick and place)

## 2. QUICK REFERENCE GUIDE

Technical Features	802.11 b/g/n	802.11 ac/a/n
Frequency Range	2.4 – 2.5 GHz	4.9 – 5.875 GHz
Average Efficiency	66.5 %	75.9 %
Peak Gain	1.5 dBi	4.7 dBi
VSWR	< 2:1	< 2:1
Radiation Pattern	Omnidirectional	
Polarization	Linear	
Weight (approx.)	0.1 g	
Temperature	-40 to +125° C	
Impedance	50 Ω	
Dimensions (L x W x H)	7.0 mm x 3.0 mm x 2.0 mm	

**Table 1** – Technical Features. Measures from the evaluation board. See Figure 1 and picture in page 5.

Please contact [support@ignion.io](mailto:support@ignion.io) if you require additional information on antenna integration or optimization on your PCB.

## 3. ELECTRICAL PERFORMANCE

### 3.1. EVALUATION BOARD

The Ignion configuration used in testing the Compact Dual-band Reach Xtend™ chip antenna is displayed in Figure 1.

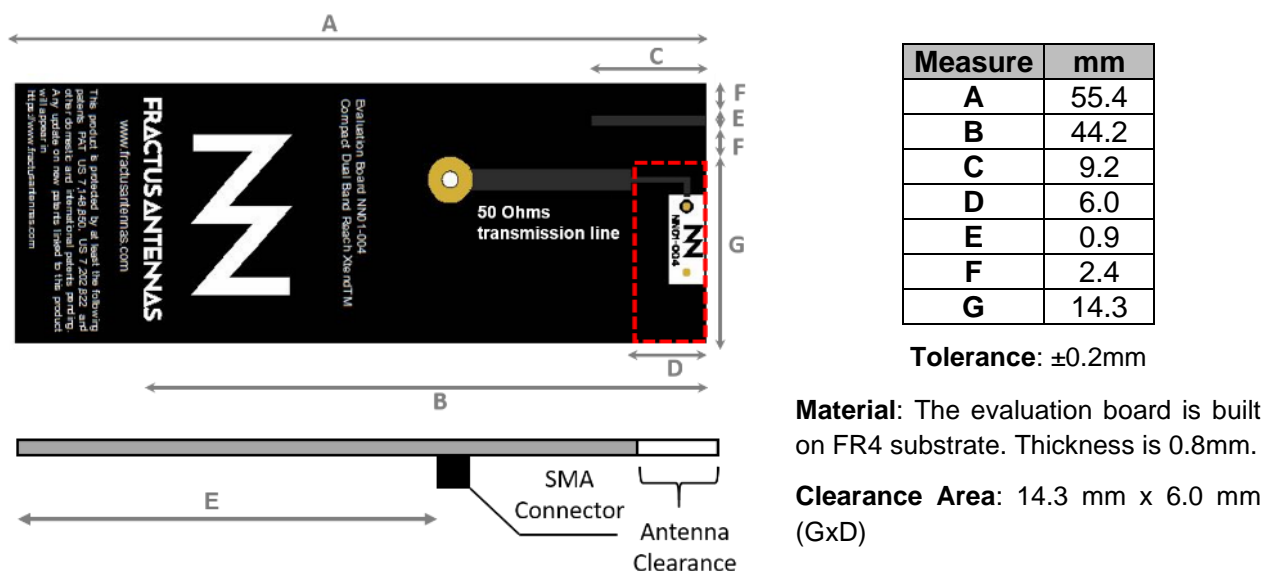

**Figure 1** – EB\_NN01-004. Compact Dual-band Reach Xtend™ Evaluation Board.

## 3.2. MATCHING NETWORK

The specs of a Ignion standard antenna are measured in their evaluation board, which is an ideal case. In a real design, components nearby the antenna, LCD's, batteries, covers, connectors, etc. affect the antenna performance. This is the reason why it is highly recommended placing pads compatible with 0402 and 0603 SMD components for a PI matching network as close as possible to the antenna feeding point. Do it in the ground plane area, not in the clearance area. This is a degree of freedom to tune the antenna once the design is finished and taking into account all elements of the system (batteries, displays, covers, etc.).

Please notice that different devices with different ground planes and different components nearby the Compact Dual-band Reach Xtend™ antenna may need a different matching network. To ensure optimal results, the use of high Q and tight tolerance components is highly recommended (Murata components). If you need assistance to design your matching network, please contact [support@ignion.io](mailto:support@ignion.io), or try our free-of-charge<sup>1</sup> **NN Wireless Fast-Track** design service, you will get your chip antenna design including a custom matching network for your device in 24h<sup>1</sup>. Other related to NN's range of R&D services is available at: <https://www.ignion.io/rdservices/>

## 3.3. VSWR AND EFFICIENCY

VSWR (Voltage Standing Wave Ratio) and Total Efficiency versus Frequency (GHz).

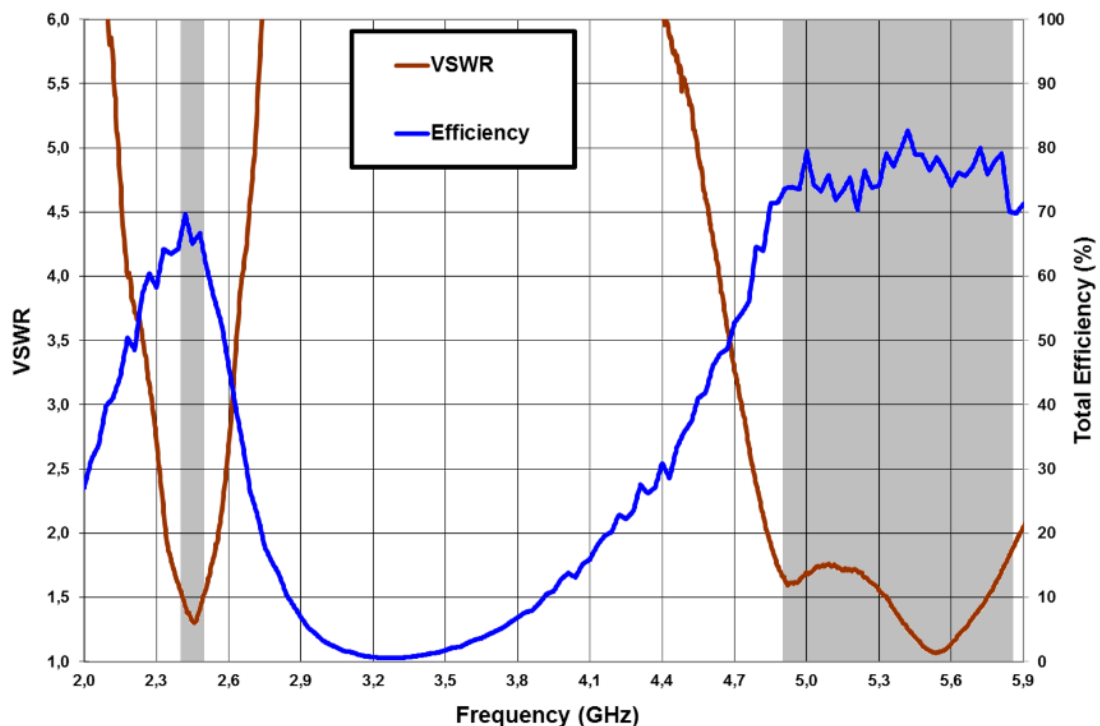
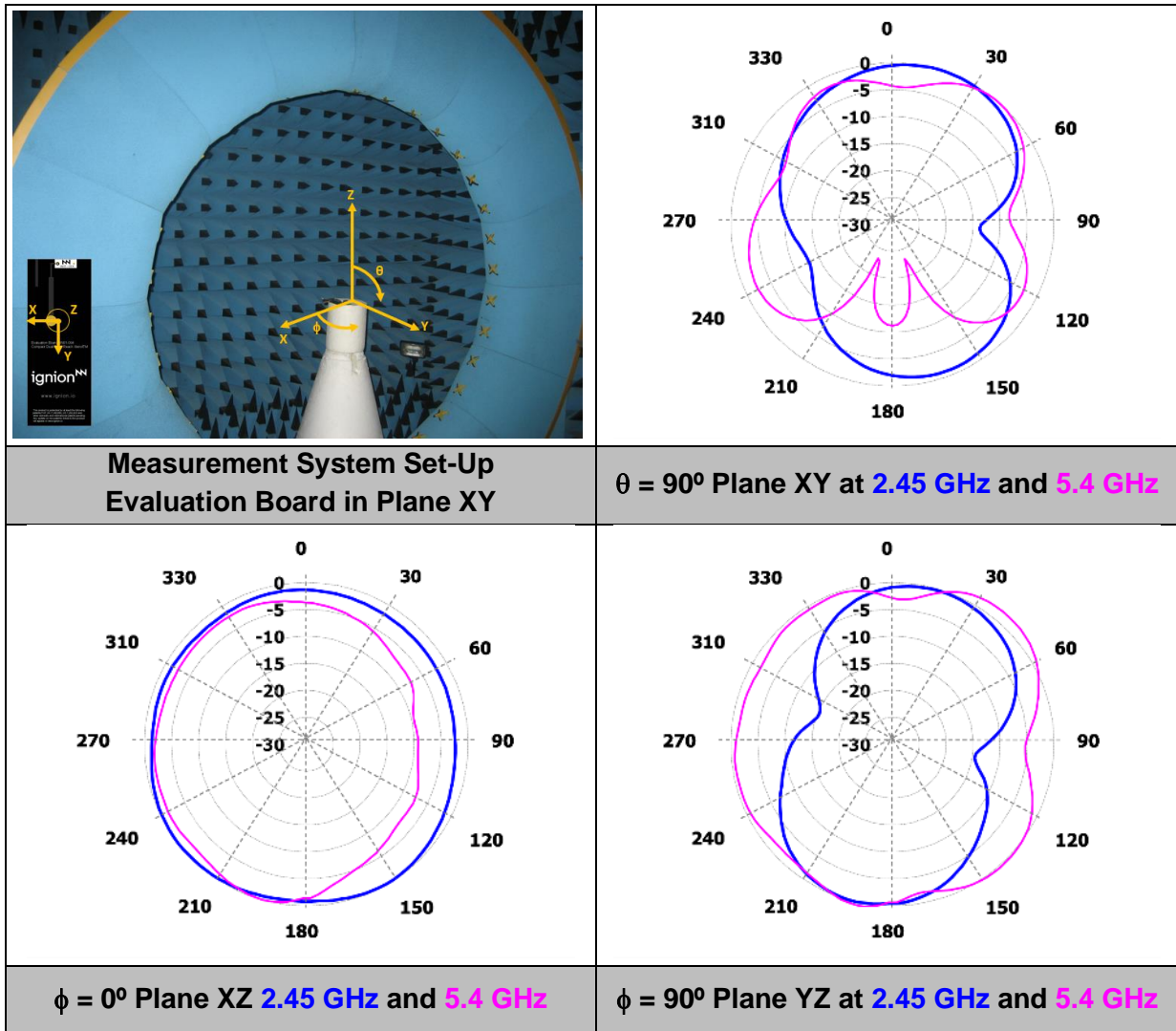

Figure 2 – VSWR and Efficiency (%) vs. Frequency (GHz).

<sup>1</sup> See terms and conditions for a free NN Wireless Fast-Track service in 24h at: <https://www.ignion.io/fast-track-project/>

### 3.4. RADIATION PATTERNS, GAIN AND EFFICIENCY



		2.4 – 2.5 GHz	4.9 – 5.875 GHz
<b>Gain</b>	<b>Peak Gain</b>	1.5 dBi	4.7 dBi
	<b>Average Gain across the band</b>	1.2 dBi	3.1 dBi
	<b>Gain Range across the band (min, max)</b>	0.8 $\leftrightarrow$ 1.5 dBi	1.5 $\leftrightarrow$ 4.7 dBi
<b>Efficiency</b>	<b>Peak Efficiency</b>	69.6 %	82.8 %
	<b>Average Efficiency across the band</b>	66.5 %	75.9 %
	<b>Efficiency Range across the band (min, max)</b>	63.0 – 69.6 %	69.8 – 82.8 %

**Table 2** – Antenna Gain and Efficiency within the 2.4 – 2.5 GHz band and the 4.9 – 5.875 GHz band. Measures made in the evaluation board and in the Satimo STARGATE 32 anechoic chamber.



### 3.5. CAPABILITIES AND MEASUREMENT SYSTEMS

Ignion specializes in the design and manufacture of optimized antennas for wireless applications, and with the provision of RF expertise to a wide range of clients. We offer turn-key antenna products and antenna integration support to minimize your time requirements and maximize return on investment throughout the product development process. We also provide our clients with the opportunity to leverage our in-house testing and measurement facilities to obtain accurate results quickly and efficiently.

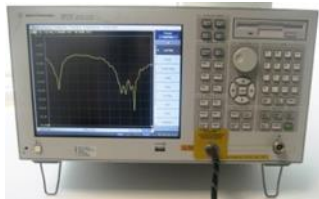

**Agilent E5071B**

VSWR  
 &  
 S Parameters

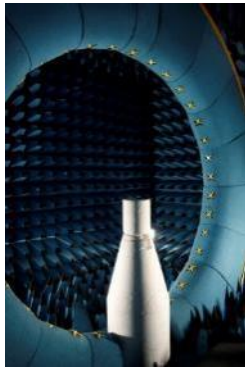
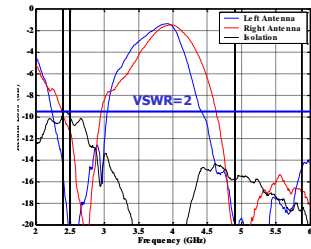

**SATIMO STARGATE 32**

Radiation  
 Pattern  
 &  
 Efficiency

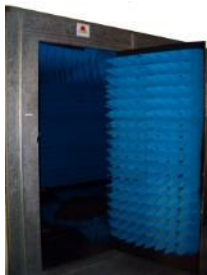
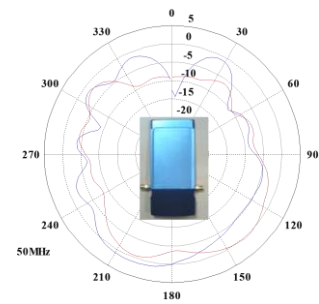

Anechoic chambers and full equipped in-house lab

## 4. MECHANICAL CHARACTERISTICS

### 4.1. DIMENSIONS AND TOLERANCES

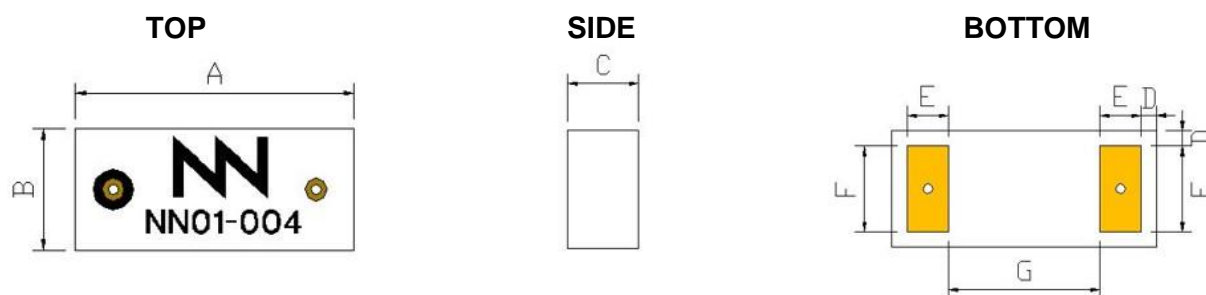

The black circle located on the top side of the antenna indicates the feed pad.

Measure	mm	Measure	mm
<b>A</b>	7.0 ± 0.2	<b>E</b>	1.1 ± 0.1
<b>B</b>	3.0 ± 0.2	<b>F</b>	2.2 ± 0.1
<b>C</b>	2.0 ± 0.2	<b>G</b>	4.0 ± 0.2
<b>D</b>	0.4 ± 0.15		

**Figure 3 – Antenna Dimensions and Tolerances.**

The Compact Dual-band Reach Xtend™ chip antenna is compliant with the restriction of the use of hazardous substances (**RoHS**). The RoHS certificate can be downloaded from [www.ignion.io](http://www.ignion.io).

### 4.2. SPECIFICATIONS FOR THE INK

Next figure shows the correct colors of the antenna:

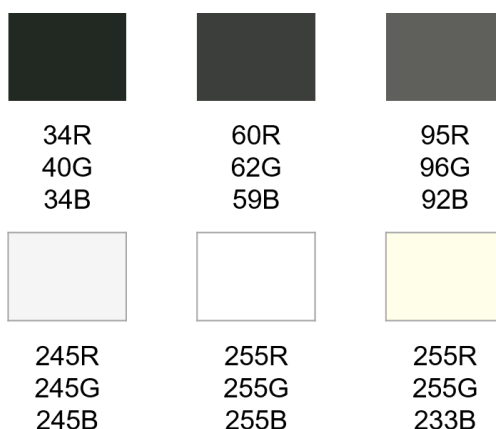

Acceptable color range

### 4.3. ANTENNA FOOTPRINT

This antenna footprint applies for the reference evaluation board described on page 6 of this User Manual. Feeding line dimensions over the clearance zone described in Figure 4 apply for a 0.8 mm thickness FR4 PCB.

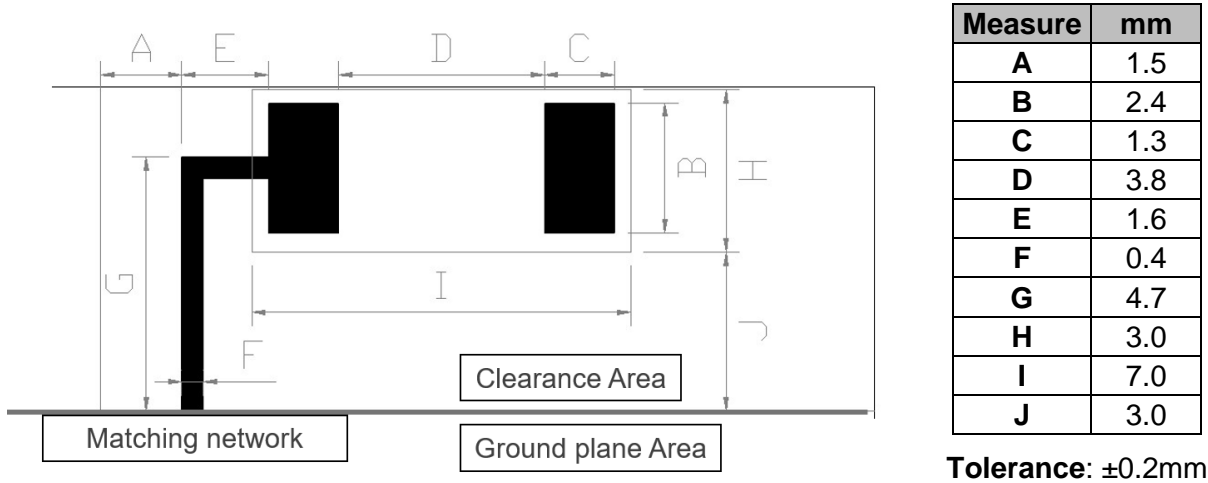

Figure 4 – Antenna Footprint Details.

Other PCB form factors and configurations may require a different feeding configuration, feeding line dimensions and clearance areas. If you require support for the integration of the antenna in your design, please contact [support@ignion.io](mailto:support@ignion.io)

## 5. ASSEMBLY PROCESS

Figure 6 – Pads of the Compact Dual-band Reach Xtend<sup>™</sup> chip antenna.

Figure 6 shows the back and front view of the Compact Dual-band Reach Xtend<sup>™</sup> chip antenna, and indicates the location of the feeding point and the mounting pads:

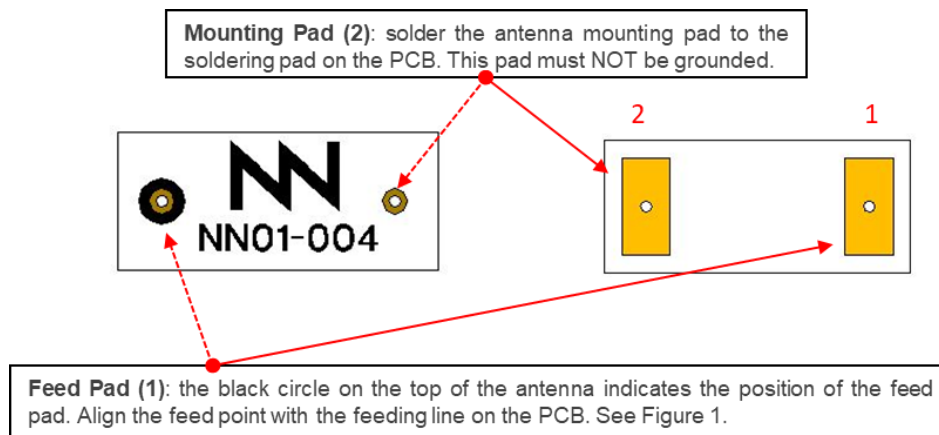
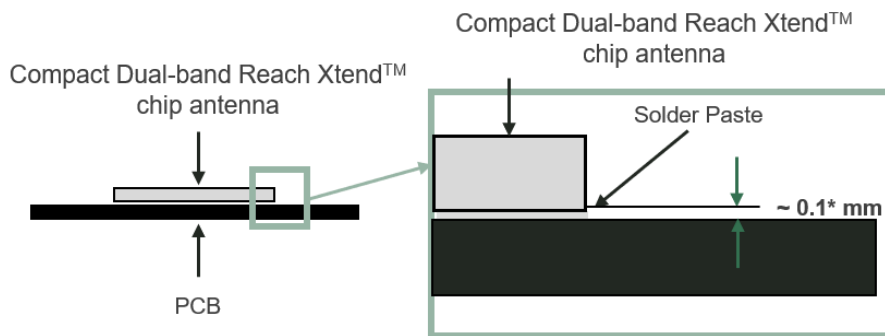

Figure 6 – Pads of the Compact Dual-band Reach Xtend<sup>™</sup> chip antenna.

As a surface mount device (SMD), this antenna is compatible with industry standard soldering processes. The basic assembly procedure for this antenna is as follows:

1. Apply a solder paste to the pads of the PCB. Place the antenna on the board.
2. Perform a reflow process according to the temperature profile detailed in Table 3, Figure on page 13.
3. After soldering the antenna to the circuit board, perform a cleaning process to remove any residual flux. Ignion recommends conducting a visual inspection after the cleaning process to verify that all reflux has been removed.

The drawing below shows the soldering details obtained after a correct assembly process:



**Figure 7 – Soldering Details.**

**NOTE(\*):** Solder paste thickness after the assembly process will depend on the thickness of the soldering stencil mask. A stencil thickness equal to or larger than **127 microns (5 mils)** is required.

The Compact Dual-band Reach Xtend™ antenna should be assembled following either Sn-Pb or Pb-free assembly processes. According to the Standard **IPC/JEDEC J-STD-020C**, the temperature profile suggested is as follows:

Phase	Profile features	Pb-Free Assembly (SnAgCu)
<b>RAMP-UP</b>	Avg. Ramp-up Rate (T <sub>smax</sub> to T <sub>p</sub> )	3 °C / second (max.)
<b>PREHEAT</b>	- Temperature Min (T <sub>smin</sub> ) - Temperature Max (T <sub>smax</sub> ) - Time (t <sub>smin</sub> to t <sub>smax</sub> )	150 °C 200 °C 60-180 seconds
<b>REFLOW</b>	- Temperature (T <sub>L</sub> ) - Total Time above T <sub>L</sub> (t <sub>L</sub> )	217 °C 60-150 seconds
<b>PEAK</b>	- Temperature (T <sub>p</sub> ) - Time (t <sub>p</sub> )	260 °C 20-40 seconds
<b>RAMP-DOWN</b>	Rate	6 °C/second max
<b>Time from 25 °C to Peak Temperature</b>		8 minutes max

**Table 3 – Recommended soldering temperatures.**

Next graphic shows temperature profile (grey zone) for the antenna assembly process in reflow ovens.

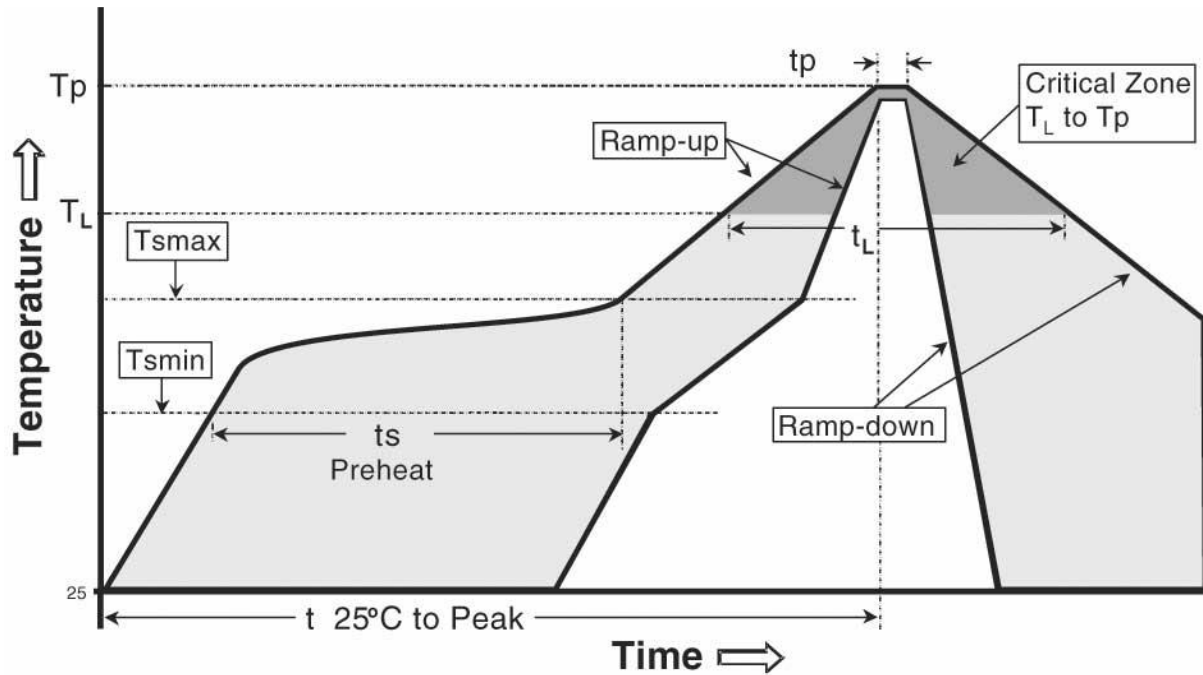
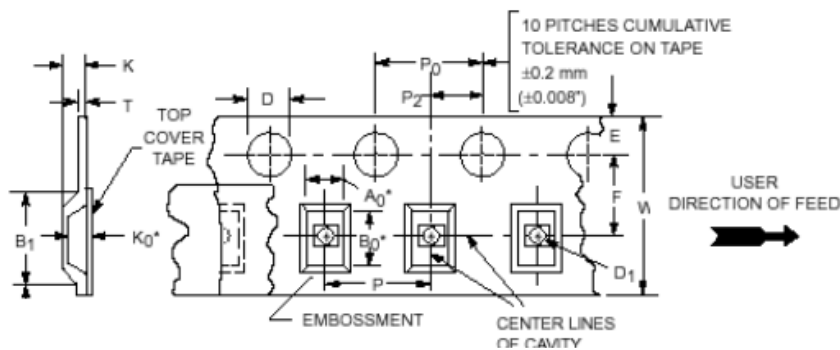

Figure 8 – Temperature profile.

## 6. PACKAGING

The Compact Dual-band Reach Xtend™ chip antenna is available in tape and reel packaging.



Measure	mm
W	16.0 ± 0.3
A0	3.6 ± 0.1
B0	7.5 ± 0.1
K0	2.5 ± 0.1
B1	8.1 ± 0.1
D	1.55 ± 0.05
D1	1.55 ± 0.05
Wmax	16.3
E	1.7 ± 0.1
F	7.5 ± 0.1
K	2.8 ± 0.1
P	8.0 ± 0.1
P0	4.0 ± 0.1
P2	2.0 ± 0.1

Figure 9 – Tape Dimensions and Tolerances.

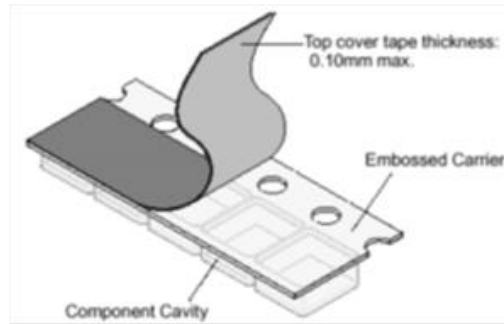

**Figure 10** – Images of the tape.

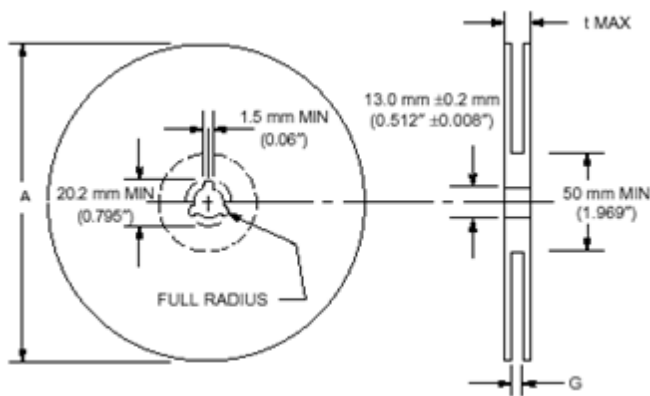

Measure	mm
<b>A max</b>	330.0 ± 1.0
<b>G</b>	17.5 ± 0.2
<b>t max</b>	21.5 ± 0.2

**Reel Capacity:** 2500 antennas

**Figure 5** – Reel Dimensions and Capacity.

## 7. PRODUCT CHANGE NOTIFICATION

This document is property of Ignion,  
Not to disclose or copy without prior written consent

PCN Number: NN19100001

Notification Date: October 07<sup>th</sup>, 2019

### Part Number identification:

Part Number changes, it will be applied in all the document of the company (User Manual, Data Sheet, ...)

Previous Part Number
FR05-S1-NO-1-004

New Part Number
NN01-004

### Reason for change:

<input type="checkbox"/> Specs (electrical/mechanical)	<input type="checkbox"/> Manufacturing location
<input type="checkbox"/> User Manual/Data Sheet	<input type="checkbox"/> Quality/Reliability
<input type="checkbox"/> Material/Composition	<input type="checkbox"/> Logistics
<input type="checkbox"/> Processing/Manufacturing	<input checked="" type="checkbox"/> Other: Logo, product color and Part Number

### Change description

- 1.- Part Number: From FR05-S1-NO-1-004 FRACTUS to NN01-004 Ignion in the User Manual
- 2.- Color: From orange/black to white/black

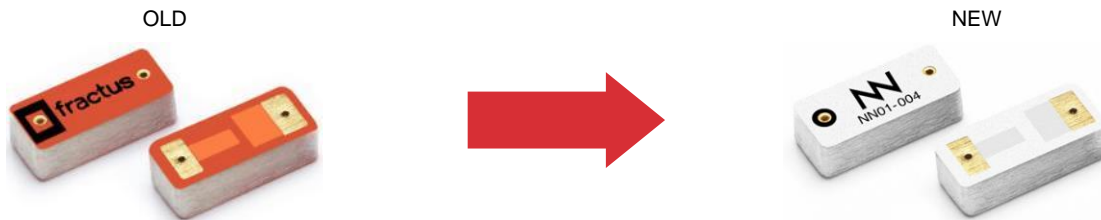

### Comments:

- 1.- Electrical and Mechanical specs remain the same
- 2.- Footprint in the PCB to solder the chip antenna remains the same

### Identification method

- 1.- In the chip antennas, the changes are in the color, in the logo and in the part number

User Manual	<input checked="" type="checkbox"/>	Available from: March 2020
Samples	<input checked="" type="checkbox"/>	Available from: March 2020

### Ignion Contact:

	Sales	Supply Chain
Name:	Josep Portabella	Albert Vidal
Email:	<a href="mailto:josep.portabella@ignion.io">josep.portabella@ignion.io</a>	<a href="mailto:albert.vidal@ignion.io">albert.vidal@ignion.io</a>