

ignion<sup>™</sup>

Your innovation.  
Accelerated.

# **EZConnect<sup>™</sup> (NN01-105) – Zigbee, RFID, ISM 868/915**

USER MANUAL  
EZConnect<sup>™</sup> (NN01-105)

## EZConnect™ (NN01-105) – Zigbee, RFID, ISM 868/915

Ignion specializes in enabling effective mobile communications. Using Ignion technology, we design and manufacture optimized antennas to make your wireless devices more competitive. Our mission is to help our clients develop innovative products and accelerate their time to market through our expertise in antenna design, testing and manufacturing.



EZConnect™

NN01-105

Ignion products are protected by [Ignion patents](#).

All information contained within this document is property of Ignion and is subject to change without prior notice. Information is provided “as is” and without warranties. It is prohibited to copy or reproduce this information without prior approval.

Ignion is an ISO 9001:2015 certified company. All our antennas are lead-free and RoHS compliant.

ISO 9001: 2015 Certified



## INDEX OF CHAPTERS

<b>1. ANTENNA DESCRIPTION</b>	<b>5</b>
<b>2. QUICK REFERENCE GUIDE</b>	<b>5</b>
<b>3. ELECTRICAL PERFORMANCE</b>	<b>6</b>
<b>4. MECHANICAL CHARACTERISTICS</b>	<b>10</b>
<b>5. ASSEMBLY PROCESS</b>	<b>11</b>
<b>6. PACKAGING</b>	<b>14</b>
<b>7. PRODUCT CHANGE NOTIFICATION</b>	<b>15</b>

## TABLE OF CONTENTS

<b>1. ANTENNA DESCRIPTION</b>	<b>5</b>
<b>2. QUICK REFERENCE GUIDE</b>	<b>5</b>
<b>3. ELECTRICAL PERFORMANCE</b>	<b>6</b>
<b>3.1. IGNION EVALUATION BOARD (902-928 MHz)</b>	<b>6</b>
<b>3.2. MATCHING NETWORK</b>	<b>6</b>
<b>3.3. VSWR AND EFFICIENCY</b>	<b>7</b>
<b>3.4. RADIATION PATTERNS (902 – 928 MHz), GAIN AND EFFICIENCY</b>	<b>8</b>
<b>3.5. CAPABILITIES AND MEASUREMENT SYSTEMS</b>	<b>9</b>
<b>4. MECHANICAL CHARACTERISTICS</b>	<b>10</b>
<b>4.1. DIMENSIONS AND TOLERANCES</b>	<b>10</b>
<b>4.2. SPECIFICATIONS FOR THE INK</b>	<b>10</b>
<b>4.3. ANTENNA FOOTPRINT (as used in the evaluation board)</b>	<b>11</b>
<b>5. ASSEMBLY PROCESS</b>	<b>11</b>
<b>6. PACKAGING</b>	<b>14</b>
<b>7. PRODUCT CHANGE NOTIFICATION</b>	<b>15</b>

## 1. ANTENNA DESCRIPTION

The EZConnect™ antenna has been specifically designed for wireless devices using Zigbee, RFID and other wireless standards operating at the ISM 868/915 MHz bands.

EZConnect™ antenna uses the space-filling properties of Ignion technology to become one of the smallest antennas for ISM868/915 applications. Additionally, the antenna maintains a high radiation efficiency that helps to improve the battery life of your devices and features an omnidirectional radiation pattern optimal for highly scattered environments such as indoor environments and public spaces.

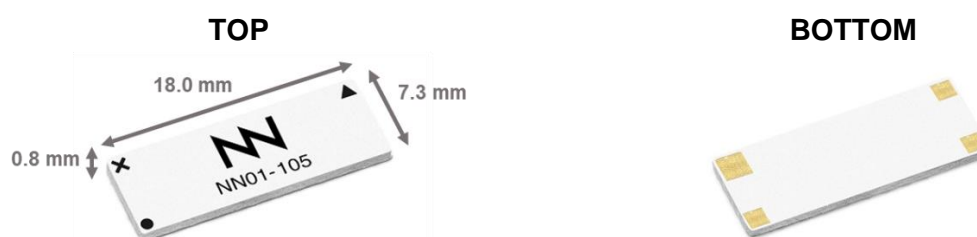

**Material:** The EZConnect™ antenna is built on glass epoxy substrate.

### APPLICATIONS

- Metering (Gas, Electricity, Water...)
- RFID (UHF Tags, Readers...)
- Sensors (Parking, Speed control, Optics...)
- Modules Zigbee
- Gateways

### BENEFITS

- High efficiency and gain
- Cost-effective
- Small size
- Easy to use (pick and place)

## 2. QUICK REFERENCE GUIDE

Technical Features	902 – 928 MHz
Average Efficiency	82.0%
Peak Gain	1.7 dBi
Radiation Pattern	Omnidirectional
VSWR	< 2:1
Polarization	Linear
Weight (approx.)	0.2 g
Temperature	-40 to +125° C
Impedance	50 Ω
Dimensions (L x W x H)	18.0 mm x 7.3 mm x 0.8 mm

**Table 1** – Technical Features. Measures from the evaluation board. See Figure 1.

Please contact [support@ignion.io](mailto:support@ignion.io) if you require additional information on antenna integration or optimization on your PCB.

### 3. ELECTRICAL PERFORMANCE

#### 3.1. EVALUATION BOARD

The 915MHz configuration for the EZConnect<sup>™</sup> chip antenna used in the PCB Evaluation Board, Figure 1 and picture in page 8 corresponds to the 902 – 928 MHz band.

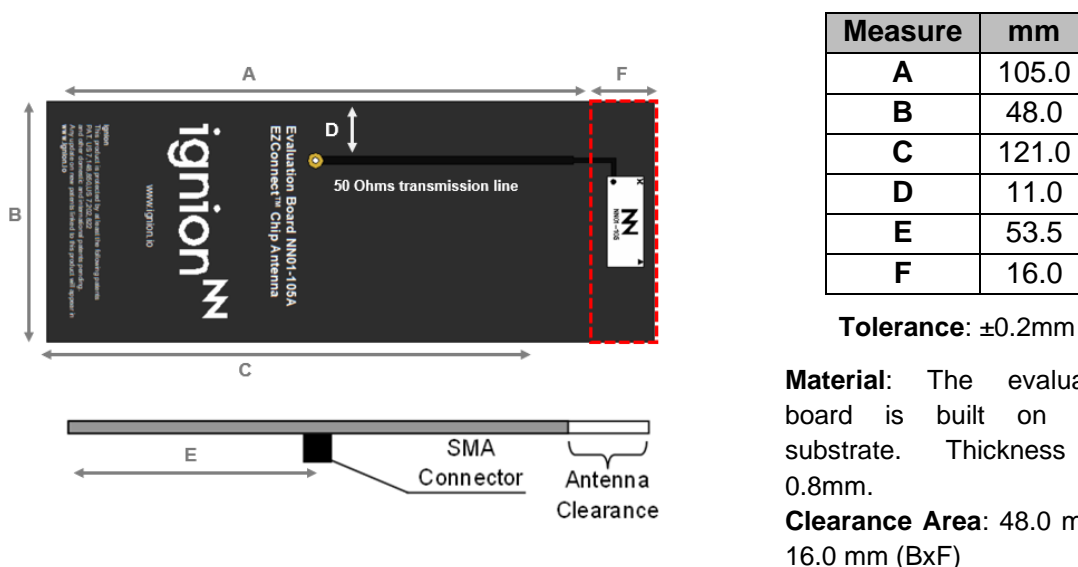

Figure 1 – EB\_NN01-105A. EZConnect<sup>™</sup> Evaluation Board in the 902 – 928 MHz band.

#### 3.2. MATCHING NETWORK

The specs of a Ignion standard antenna are measured in their evaluation board, which is an ideal case. In a real design, components nearby the antenna, LCD's, batteries, covers, connectors, etc. affect the antenna performance. This is the reason why it is highly recommended placing pads compatible with 0402 and 0603 SMD components for a PI matching network as close as possible to the antenna feeding point. Do it in the ground plane area, not in the clearance area. This is a degree of freedom to tune the antenna once the design is finished and considering all elements of the system (batteries, displays, covers, etc.).

Please notice that different devices with different ground planes and different components nearby the EZConnect<sup>™</sup> chip antenna may need a different matching network. To ensure optimal results, the use of high Q and tight tolerance components is highly recommended (Murata components). If you need assistance to design your matching network beyond this application note, please contact [support@ignion.io](mailto:support@ignion.io), or try our free-of-charge<sup>1</sup> **NN Wireless Fast-Track** design service, you will get your chip antenna design including a custom matching network for your device in 24h<sup>1</sup>. Other related to NN's range of R&D services is available at: <https://www.ignion.io/rdservices/>

<sup>1</sup> See terms and conditions for a free NN Wireless Fast-Track service in 24h at: <https://www.ignion.io/fast-track-project/>

### 3.3. VSWR AND EFFICIENCY

VSWR (Voltage Standing Wave Ratio) and Total Efficiency versus Frequency (GHz).

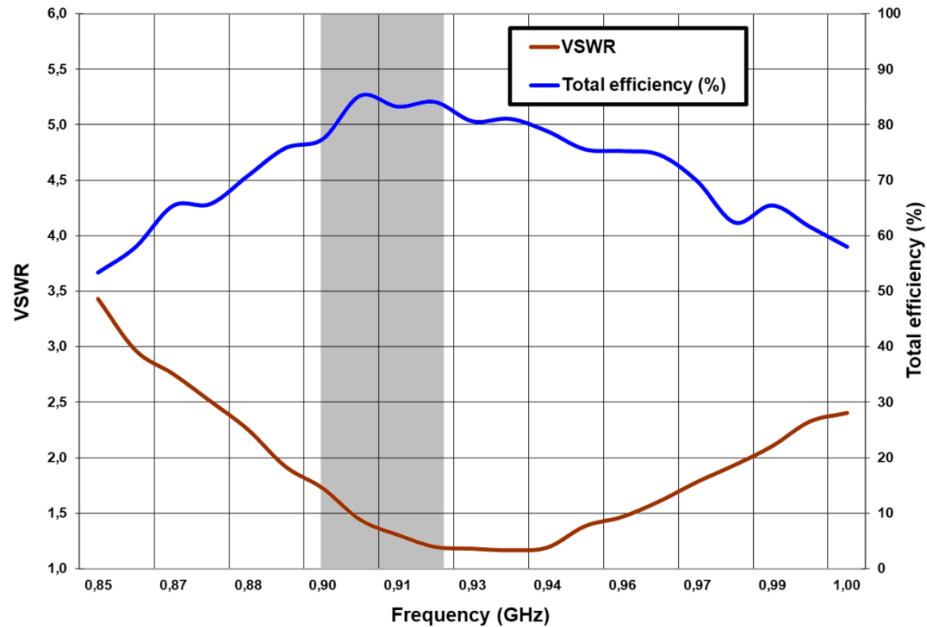

**Figure 2** – VSWR and Efficiency (%) vs. Frequency (GHz).

**NOTE:** to work at **ISM 868 MHz** band in the EZConnect™ antenna, please download the following [application](#) in [www.ignion.io](http://www.ignion.io).

### 3.4. RADIATION PATTERNS (902 – 928 MHz), GAIN AND EFFICIENCY

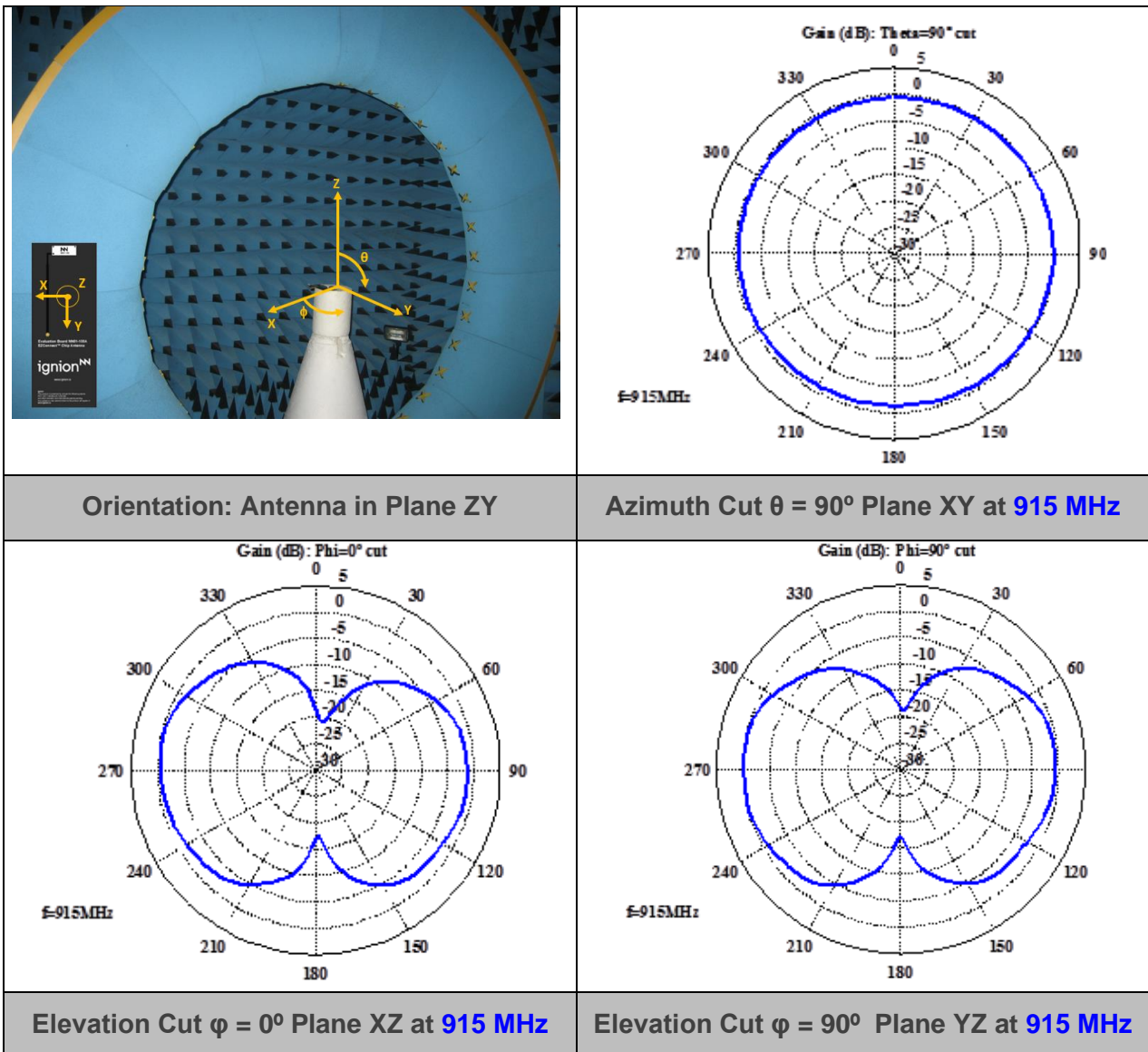

<b>Gain</b>	<b>Peak Gain</b>	1.7 dBi
	<b>Average Gain across the band</b>	1.6 dBi
	<b>Gain Range across the band (min, max)</b>	1.6 <--> 1.7 dBi
<b>Efficiency</b>	<b>Peak Efficiency</b>	85.2 %
	<b>Average Efficiency across the band</b>	82.8 %
	<b>Efficiency Range across the band (min, max)</b>	80.0 – 85.2 %

**Table 2** – Antenna Gain and Efficiency within the 902 – 928 MHz band. Measures made in the evaluation board and in the Satimo STARGATE 32 anechoic chamber.



### 3.5. CAPABILITIES AND MEASUREMENT SYSTEMS

Ignion specializes in the design and manufacture of optimized antennas for wireless applications, and with the provision of RF expertise to a wide range of clients. We offer turn-key antenna products and antenna integration support to minimize your time requirements and maximize return on investment throughout the product development process. We also provide our clients with the opportunity to leverage our in-house testing and measurement facilities to obtain accurate results quickly and efficiently.

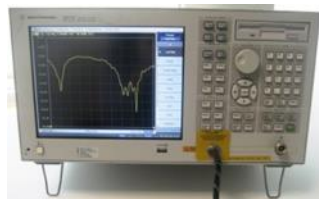

**Agilent E5071B**

VSWR  
&  
S Parameters

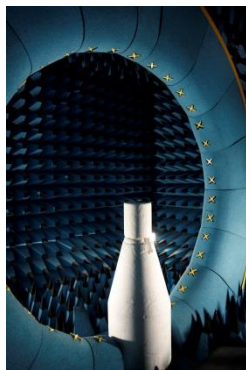
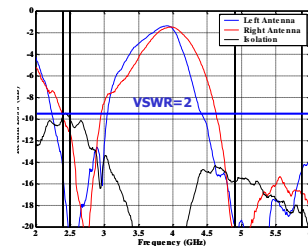

**SATIMO STARGATE 32**

Radiation  
Pattern  
&  
Efficiency

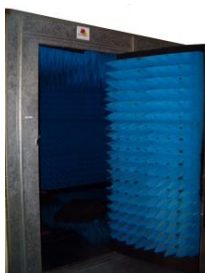
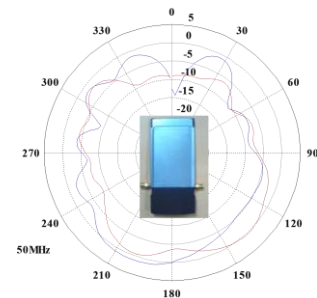

**Anechoic chambers and full equipped in-house lab**

## 4. MECHANICAL CHARACTERISTICS

### 4.1. DIMENSIONS AND TOLERANCES

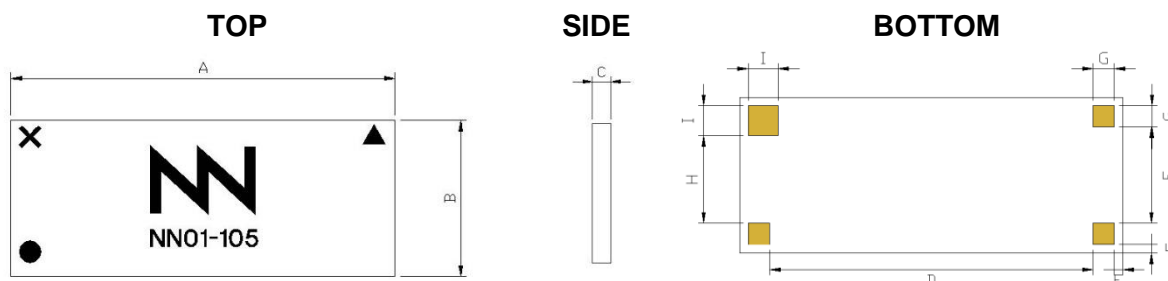

The black circle located on the bottom side of the antenna indicates the feed pad.

Measure	mm	Measure	mm
<b>A</b>	18.0 ± 0.2	<b>F</b>	4.5 ± 0.2
<b>B</b>	7.3 ± 0.2	<b>G</b>	1.0 ± 0.05
<b>C</b>	0.8 ± 0.2	<b>H</b>	4.1 ± 0.1
<b>D</b>	15.2 ± 0.2	<b>I</b>	1.4 ± 0.05
<b>E</b>	0.4 ± 0.1		

**Figure 3** – Antenna Dimensions and Tolerances.

The EZConnect™ chip antenna is compliant with the restriction of the use of hazardous substances (**RoHS**). The RoHS certificate can be downloaded from [www.ignion.io](http://www.ignion.io).

### 4.2. SPECIFICATIONS FOR THE INK

Next figure shows the correct colors of the antenna:

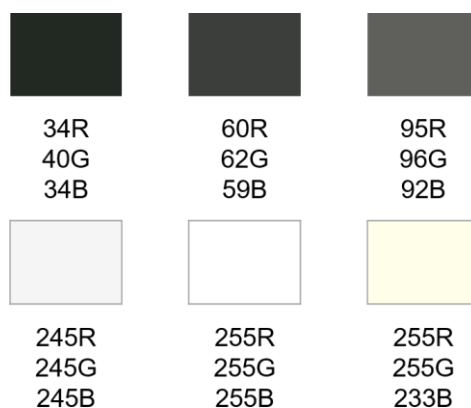

**Acceptable color range**

### 4.3. ANTENNA FOOTPRINT (as used in the evaluation board)

This antenna footprint applies for the reference evaluation board described on page 6 of this User Manual.

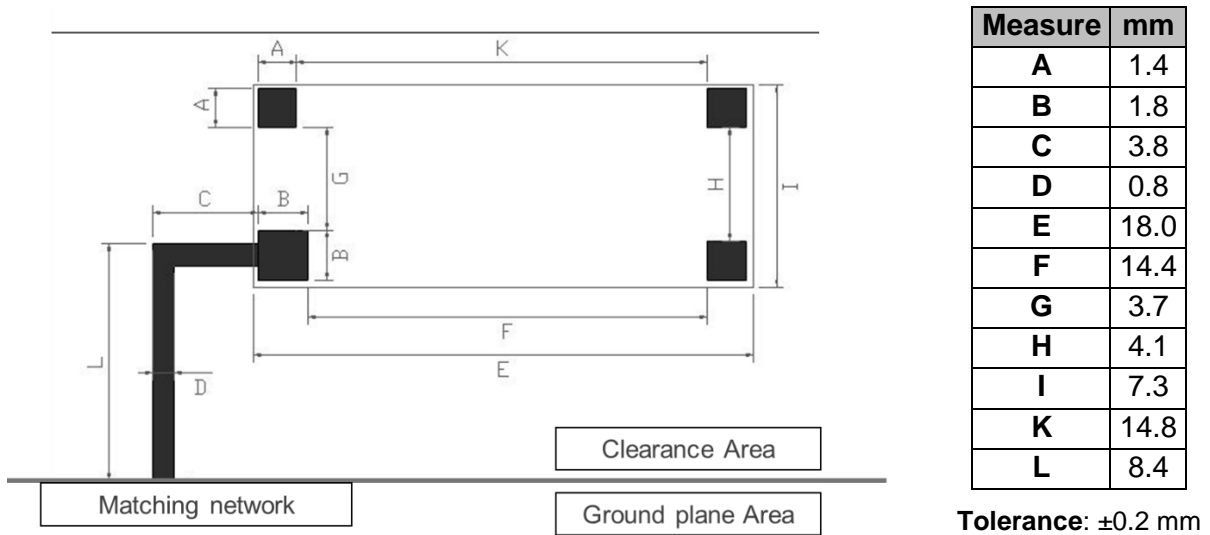

Figure 4 – Antenna Footprint Details.

Other PCB form factors and configurations may require a different feeding configuration, feeding line dimensions and clearance areas. If you require support for the integration of the antenna in your design, please contact [support@ignion.io](mailto:support@ignion.io).

## 5. ASSEMBLY PROCESS

Figure 5 shows the back and front view of the EZConnect™ antenna, and indicates the location of the feeding point and the mounting pads:

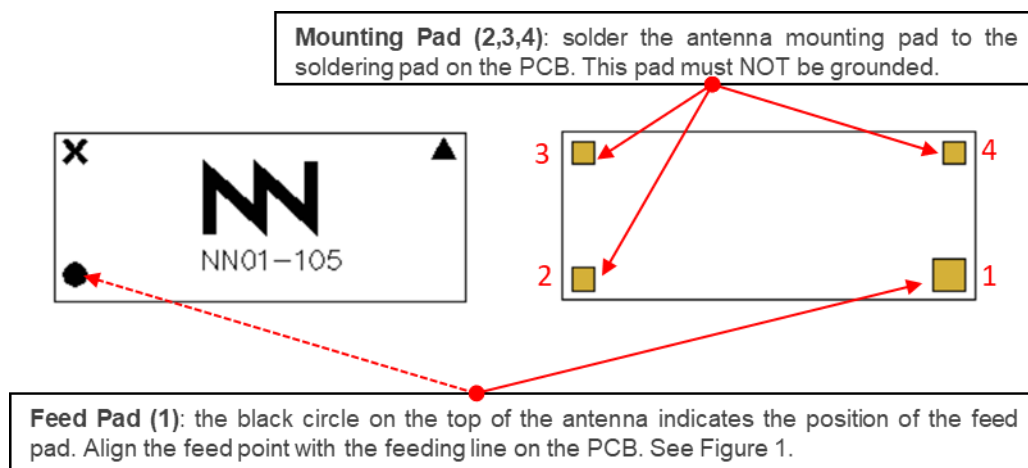
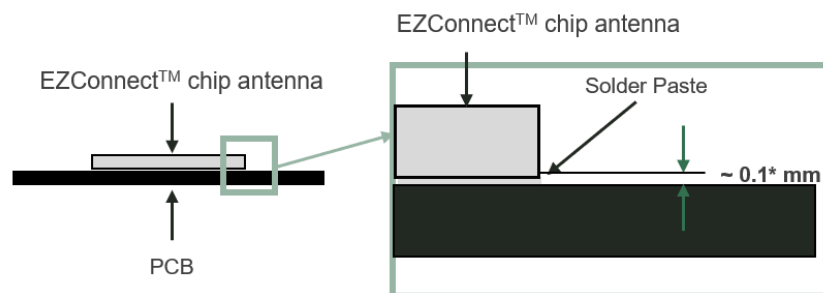

Figure 5 – Pads of the EZConnect™ chip antenna.

As a surface mount device (SMD), this antenna is compatible with industry standard soldering processes. The basic assembly procedure for this antenna is as follows:

1. Apply a solder paste to the pads of the PCB. Place the antenna on the board.
2. Perform a reflow process according to the temperature profile detailed in Table 3, Figure 7 on page 13.
3. After soldering the antenna to the circuit board, perform a cleaning process to remove any residual flux. Ignion recommends conducting a visual inspection after the cleaning process to verify that all reflux has been removed.

The drawing below shows the soldering details obtained after a correct assembly process:



**Figure 6 – Soldering Details.**

**NOTE(\*):** Solder paste thickness after the assembly process will depend on the thickness of the soldering stencil mask. A stencil thickness equal to or larger than **127 microns (5 mils)** is required.

The EZConnect<sup>™</sup> antenna should be assembled following either Sn-Pb or Pb-free assembly processes. According to the Standard **IPC/JEDEC J-STD-020C**, the temperature profile suggested is as follows:

Phase	Profile features	Pb-Free Assembly SnAgCu)
<b>RAMP-UP</b>	Avg. Ramp-up Rate (T <sub>smax</sub> to T <sub>p</sub> )	3 °C / second (max.)
<b>PREHEAT</b>	- Temperature Min (T <sub>smin</sub> ) - Temperature Max (T <sub>smax</sub> ) - Time (t <sub>smin</sub> to t <sub>smax</sub> )	150 °C 200 °C 60-180 seconds
<b>REFLOW</b>	- Temperature (T <sub>L</sub> ) - Total Time above T <sub>L</sub> (t <sub>L</sub> )	217 °C 60-150 seconds
<b>PEAK</b>	- Temperature (T <sub>p</sub> ) - Time (t <sub>p</sub> )	260 °C 20-40 seconds
<b>RAMP-DOWN</b>	Rate	6 °C/second max
<b>Time from 25 °C to Peak Temperature</b>		8 minutes max

**Table 3** – Recommended soldering temperatures.

Next graphic shows temperature profile (grey zone) for the antenna assembly process in reflow ovens.

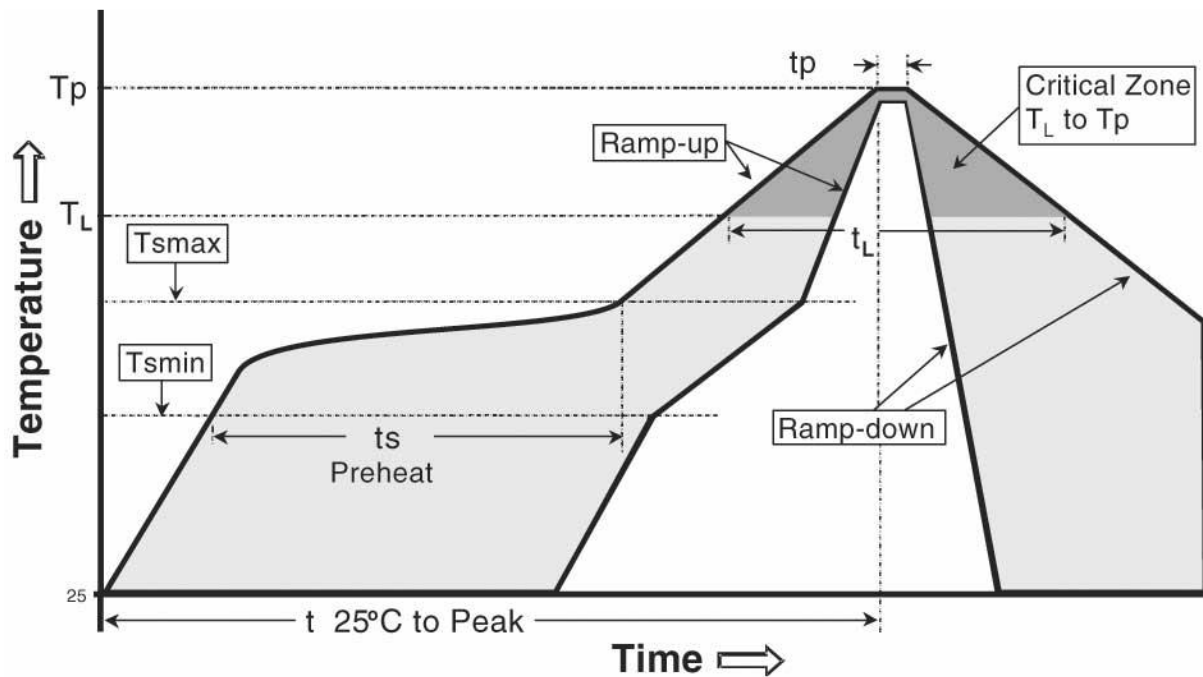

**Figure 7** – Temperature profile.

## 6. PACKAGING

The EZConnect<sup>™</sup> chip antenna is available in tape and reel packaging.

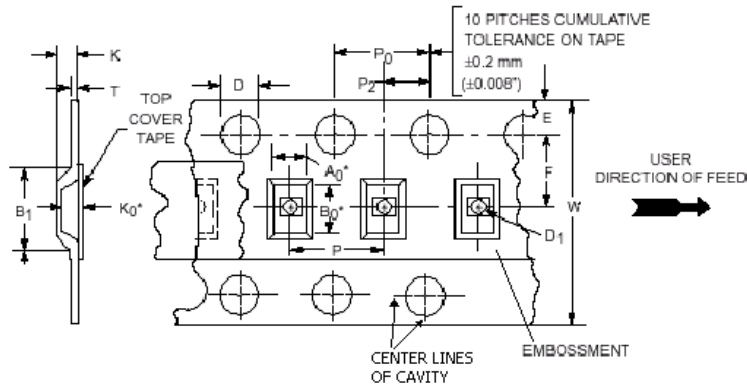

Measure	mm
W	32.0 ± 0.3
A0	7.7 ± 0.1
B0	18.3 ± 0.1
K0	1.2 ± 0.1
B1	19.1 max
D	1.55 ± 0.05
D1	2.1 min
Wmax	32.3
E	1.75 ± 0.1
F	14.2 ± 0.1
K	1.5 ± 0.1
P	12.0 ± 0.1
P0	4.0 ± 0.1
P2	2.0 ± 0.1

Figure 8 – Tape Dimensions and Tolerances.

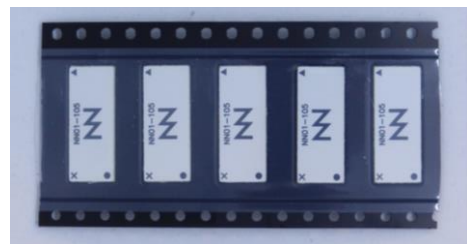
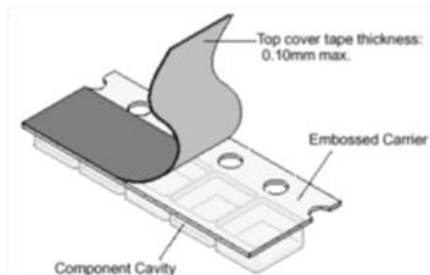
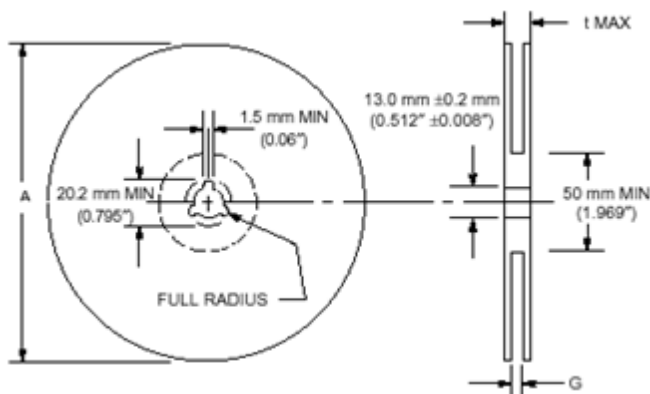

Figure 9 – Image of the tape.



Measure	mm
A max	330.0 ± 1
G	33.5 ± 0.2
t max	37.5 ± 0.2

Reel Capacity: 2500 antennas

Figure 10 – Reel Dimensions and Capacity.

## 7. PRODUCT CHANGE NOTIFICATION

This document is property of Ignion,  
Not to disclose or copy without prior written consent

PCN Number: NN19100003

Notification Date: October 17<sup>th</sup>, 2019

### Part Number identification:

Part Number changes will be applied in all the documentation of the product (User Manual, Data Sheet, ...)

Previous Part Number
FR05-S1-R-0-105

New Part Number
NN01-105

### Reason for Change:

<input type="checkbox"/>	Specs (electrical/mechanical)
<input type="checkbox"/>	User Manual/Data Sheet
<input type="checkbox"/>	Material/Composition
<input type="checkbox"/>	Processing/Manufacturing

<input type="checkbox"/>	Manufacturing location
<input type="checkbox"/>	Quality/Reliability
<input type="checkbox"/>	Logistics
<input checked="" type="checkbox"/>	Other: Logo, product color and Part Number

### Change description

- 1.- Part Number: From FR05-S1-R-0-105 FRACTUS to NN01-105 Ignion in the User Manual
- 2.- Color: From black/white to white/black

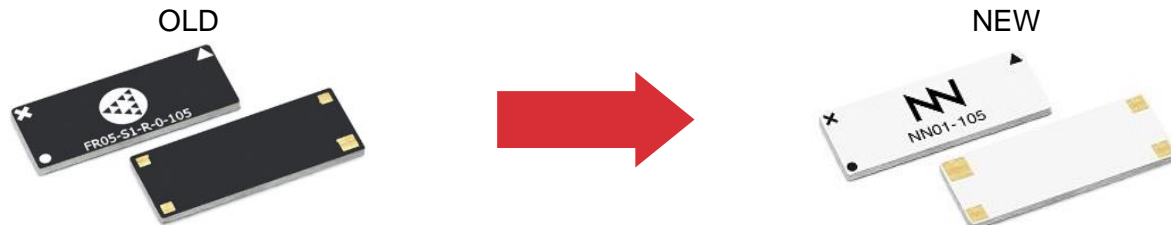

### Comments:

- 1.- Electrical and Mechanical specs remain the same
- 2.- Footprint in the PCB to solder the chip antenna remains the same

### Identification method

- 1.- The changes applied to the color, the logo, and the part number

User Manual	<input checked="" type="checkbox"/>	Available from: December 2019
Samples	<input checked="" type="checkbox"/>	Available from: December 2019

### Ignion Contact:

Sales  
Name: Josep Portabella  
Email: [josep.portabella@ignion.io](mailto:josep.portabella@ignion.io)

Supply Chain  
Albert Vidal  
[albert.vidal@ignion.io](mailto:albert.vidal@ignion.io)