

ignion 

Your innovation.
Accelerated.

RUN MXTEND™: TOP MULTIBAND CELLULAR PERFORMANCE IN A MINIMAL SIZE

USER MANUAL
RUN mXTEND™ (NN02-224)

RUN MXTEND[™]:

TOP MULTIBAND CELLULAR PERFORMANCE IN A MINIMAL SIZE



NN02-224

RUN mXTEND[™] | Mobile | IoT Antenna

Operating range: 698 - 8000 MHz

Best for: 824 - 8000 MHz

Dimensions: 12.0 mm x 3.0 mm x 2.4 mm

What is RUN mXTEND™?

RUN mXTEND™ is your chip antenna component of choice when a **high multiband cellular performance** is to be combined with a **minimal footprint** on the printed circuit board (PCB) of your mobile or IoT device. Its architecture has been optimized to deliver the top radiation performance across the whole 824 to 8000 MHz frequency range, making it the ideal component to embed multiband cellular performance (**2G, 3G, 4G, 5G**) in the smallest possible volume. RUN mXTEND™ is to replace bulky, custom made PIFA antennas in all those devices where volume and cost is constrained while a maximum performance is desired. Also, it is the ideal component for **densely crowded electronic platforms** such as for instance **massive MIMO** devices where still multiple antennas need to coexist.

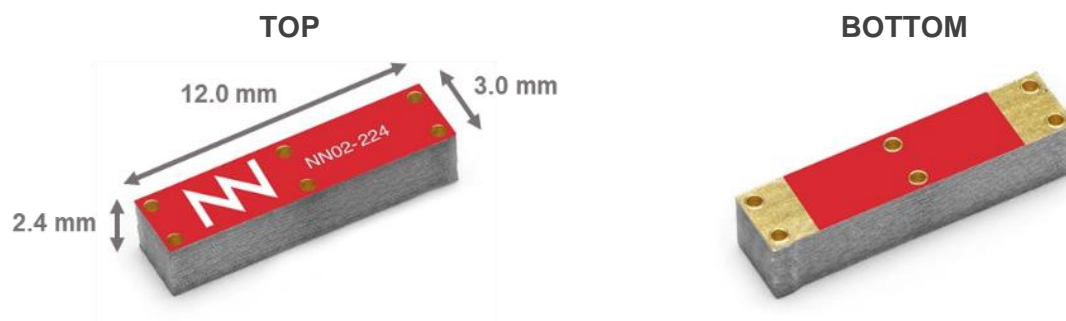

What is RUN mXTEND™ for?

RUN mXTEND™ is one of the **most versatile** and **powerful** Virtual Antenna components ever. By combining a top performance within the 824-8000 MHz frequency range with a minimal volume of 12 x 3 x 2.4 mm the antenna adapts to about every wireless device and to about any radio technology within such a frequency range. Not only a global cellular or ISM IoT connection can be delivered through RUN mXTEND™, but the same component can be used for **GNSS**, **Bluetooth** and **Wi-Fi** dual-band within the same wireless device. Such a flexibility enables simplifying procurement logistics while reducing design time and benefiting from economies of scale. While most popular applications for RUN mXTEND™ are some of the ones listed below, the flexibility and versatility of such a unique antenna component makes its range of applications almost limitless.

- IoT Asset Trackers
- Smart Meters
- 5G Routers (MIMO)
- Wi-Fi Routers (MIMO)
- Cellular/IoT Reference Designs
- Environmental Sensors
- Personal Gadget Tracker
- Notebooks/Tablets
- Health sensors
- Animal Trackers
- Point of Sales
- IoT Developer Kits
- Smart City sensors
- Point of Sales

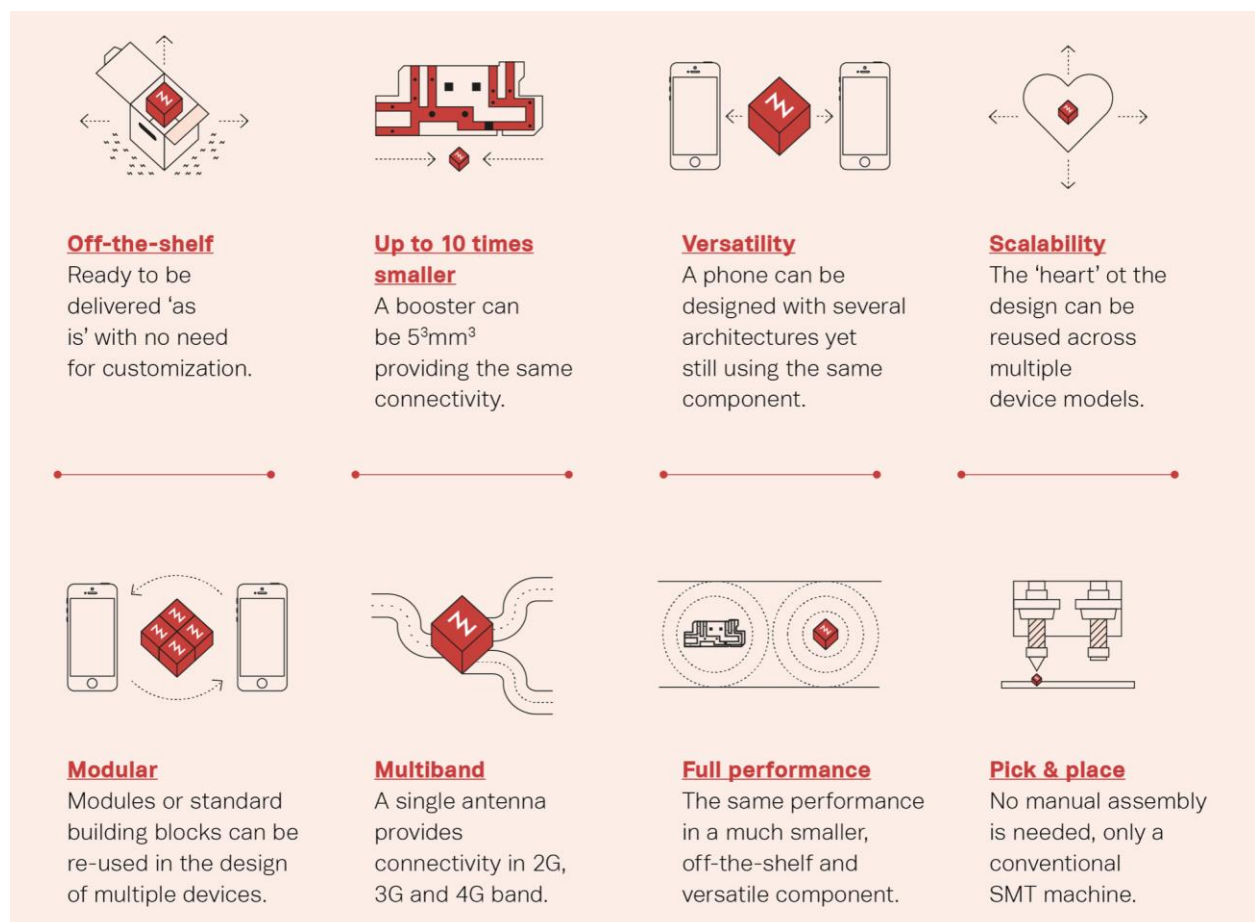

What differentiates RUN mXTEND[™] from other chip antennas?

Like every other Virtual Antenna[™] product, RUN mXTEND[™] is **frequency neutral**, meaning that its frequency response is not conditioned by the antenna component but designed by the electronics engineer through a simple matching circuit. Virtual Antenna[™] technology enables packaging the desired **multiband performance in the smallest ever form factor**, enabling the whole mXTEND range of components to feature a tiny off-the-shelf, surface-mount (SMD) electronic chip package. This makes mXTEND components easy to be integrated in about any IoT device through a shorter and simpler design cycle and a much more **robust, reliable and costs effective** assembly process.



RUN mXTEND[™] has been designed to replace custom designed PIFA antennas in multiband cellular applications: pico-cells and routers, mobile handheld devices, trackers and much more. No other chip antenna technology can deliver a full multiband cellular performance (**2G, 3G, 4G, 5G**) in such a tiny component. Being off-the-shelf, the embedding process into your product becomes much faster and easier, removing the need of cumbersome, iterative prototyping and mechanical redesign. Yet still the antenna performance can be optimized to every device and platform: **just by fine tuning the matching circuit the frequency response will be optimally tuned to your device constrain at every design iteration.**

Click and select an application that fits your project:

RUN mXTEND [™] for Cellular IoT		(824 – 2690 MHz)
RUN mXTEND [™] for GNSS		(1561 MHz – 1606) MHz)
RUN mXTEND [™] for Bluetooth/Wi-Fi		(2400 MHz – 5874 MHz)

Click to view other useful RUN mXTEND[™] guidelines:

[HOW TO EMBED A VIRTUAL ANTENNA](#)

[MECHANICAL SPECIFICATIONS](#)

[ASSEMBLY AND MANUFACTURING](#)

[PACKAGING](#)

Chapter Index

1. HOW TO EMBED A VIRTUAL ANTENNA	7
2. RUN MXTEND™ FOR CELLULAR IOT	9
3. RUN MXTEND™ FOR GNSS	15
4. RUN MXTEND™ FOR BLUETOOTH/WI-FI	24
5. MECHANICAL SPECIFICATIONS	33
6. ASSEMBLY AND MANUFACTURING	35
7. PACKAGING	37
8. PRODUCT CHANGE NOTIFICATION	39

How to embed a Virtual Antenna

Design with Virtual Antenna in 1-2-3

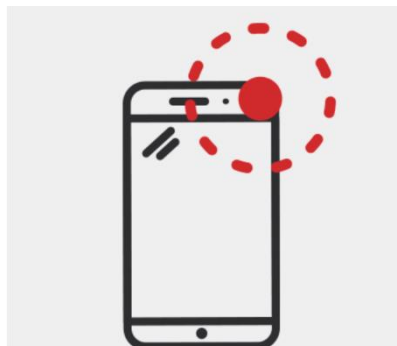

STEP 1: Place the antenna component

1. Select one corner of your PCB
2. Ensure your ground plane meets the RUN mXTEND™ clearance area restrictions
3. Respect a keep out space around the booster. Keep at least 5mm distance from metallic objects

Look [here](#) for an example on placing the RUN mXTEND™

STEP 2: Design your matching network

1. Through a combination of inductors & capacitors obtain 50 Ohms of antenna impedance to optimize the transfer of energy to your antenna
2. It is critical to fine-tune your MN throughout the entirety the design process of achieve your desired frequency response



Look [here](#) for an example of a matching network designed for a RUN mXTEND™ application via simulation

STEP 3: Test your device

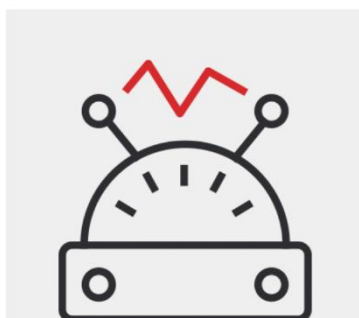

1. Perform a field test in which your antenna is placed in its final housing. Fine-tune the MN if needed.
2. Use a network analyzer to adjust mismatch
3. Test the antennas efficiency with an anechoic chamber

Look [here](#) for testing we did on our Evaluation Board, with the RUN mXTEND™ integrated in our Anechoic Chamber

<https://www.ignion.io/tutorials>

Scan QR code to be taken to our videos highlighting these three easy steps





Need further help? Easy start with NN Wireless Fast Track

Do you need more help with your antenna for your device?

Use our **NN Wireless Fast Track service** and get your ready-to-test, proof-of-concept antenna design especially simulated for your platform **free of charge**¹, and in **24 hours**.

1. Fill out the form, submit it and receive a confirmation email.
2. Reply to the email to confirm the data for your project is correct.
3. Get your design in 24h.

<https://www.ignion.io/fast-track-project/>



Scan QR code
to be taken to
our Wireless
Fast Track
page

RUN mXTEND[™] for Cellular IoT

The RUN mXTEND[™] antenna booster has been specifically designed for providing multiband performance, particularly in mobile and cellular devices, enabling worldwide coverage by allowing operation in the communication standards GSM850, GSM900, GSM1800/DCS, GSM1900/PCS, UMTS, LTE850, LTE900, LTE1700, LTE1800, LTE1900, LTE2000, LTE2100, LTE2300, LTE2500, and LTE2600.

Using one of our Evaluation Boards, an example of a common RUN mXTEND[™] placement is shown here. Finally, one matching network is selected, allowing us to test, obtain, and analyze the VSWR, total efficiency, gain and radiation patterns.

QUICK REFERENCE GUIDE

Technical features	824 – 960 MHz	1710 – 2690 MHz
Average Efficiency	> 65 %	> 70 %
Peak Gain	2.8 dBi	1.8 dBi
VSWR	< 3:1	
Radiation Pattern	Omnidirectional	
Polarization	Linear	
Weight (approx.)	0.19 g	
Temperature	-40 to + 125 °C	
Impedance	50 Ω	
Dimensions (L x W x H)	12.0 mm x 3.0 mm x 2.4 mm	

Table 1 – Technical Features. Measures from the Evaluation Board. See **Figure 1**. Note that for obtaining comparable results, a ground plane length larger than 100 mm is recommended.

ELECTRICAL PERFORMANCE

EVALUATION BOARD

This Evaluation Board integrates a UFL cable to connect the RUN mXTEND™ antenna booster with the SMA connector. The RUN mXTEND™ provides operation in two frequency regions, from 824 MHz to 960 MHz and from 1710 MHz to 2690 MHz, through a single input/output port.

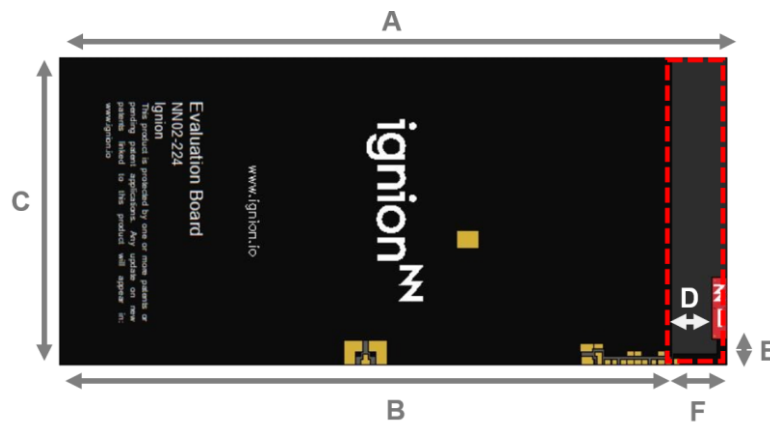

Measure	mm
A	131
B	120
C	60
D	8.0
E	5.0
F	11.0

Tolerance: ±0.2 mm

D: Distance between the RUN mXTEND™ antenna booster and the ground plane.

Material: The evaluation board is built on FR4 substrate. Thickness is 1 mm.

Clearance Area: 60 mm x 11 mm (Cx F)

Figure 1 – EB_NN02-224-1B-2RJ-1P. Evaluation Board providing operation from 824 MHz to 960 MHz and from 1710 MHz to 2690MHz.

This product and its use is protected by at least one or more of the following [patents and patent applications](#) US 8,203,492; US 8,237,615; PCT/EP2013/064692; WO2014/012842; US 62/028,494; US 62/072,671; and other domestic and international patents pending. Additional information about patents related to this product is available at www.ignion.io/virtual-antenna/.

MATCHING NETWORK

The specs of a Ignion standard product are measured in their evaluation board, which is an ideal case. In a real design, components nearby the antenna, LCD's, batteries, covers, connectors, etc. might affect the antenna performance. To optimize performance, it is highly recommended placing pads compatible with 0402 and 0603 SMD components for a matching network as close as possible to the feeding point. Do it in the ground plane area, not in the clearance area. This provides a degree of freedom to fine tune the RUN mXTEND™ antenna booster once the design is finished with all elements of the system in place (batteries, displays, covers, etc.).

Please notice that different devices with different ground planes and different components nearby the RUN mXTEND™ antenna booster may need a different matching network. To ensure optimal results, the use of high Q and tight tolerance components is highly recommended. If you need assistance to design your matching network, please contact support@ignion.io, or try our free-of-charge¹ **NN Wireless Fast-Track** design service, you will get your chip antenna design including a custom matching network for your device in 24h¹. Other related to NN's range of R&D services is available at: <https://www.ignion.io/rdservices/>

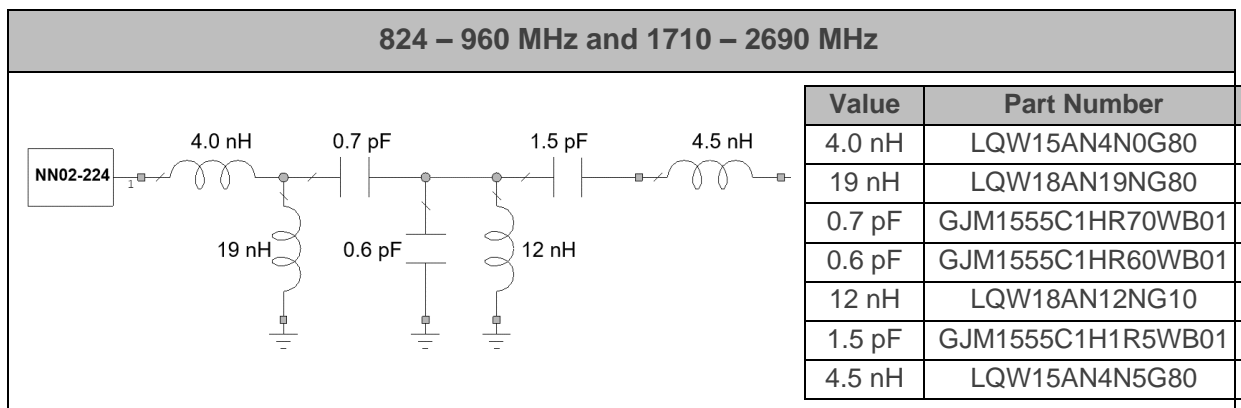

Figure 2 – Matching Network implemented in the evaluation board (Figure 1).

¹ See terms and conditions for a free NN Wireless Fast-Track service in 24h at: <https://www.ignion.io/fast-track-project/>

VSWR AND TOTAL EFFICIENCY

VSWR (Voltage Standing Wave Ratio) and Total Efficiency versus Frequency (GHz).

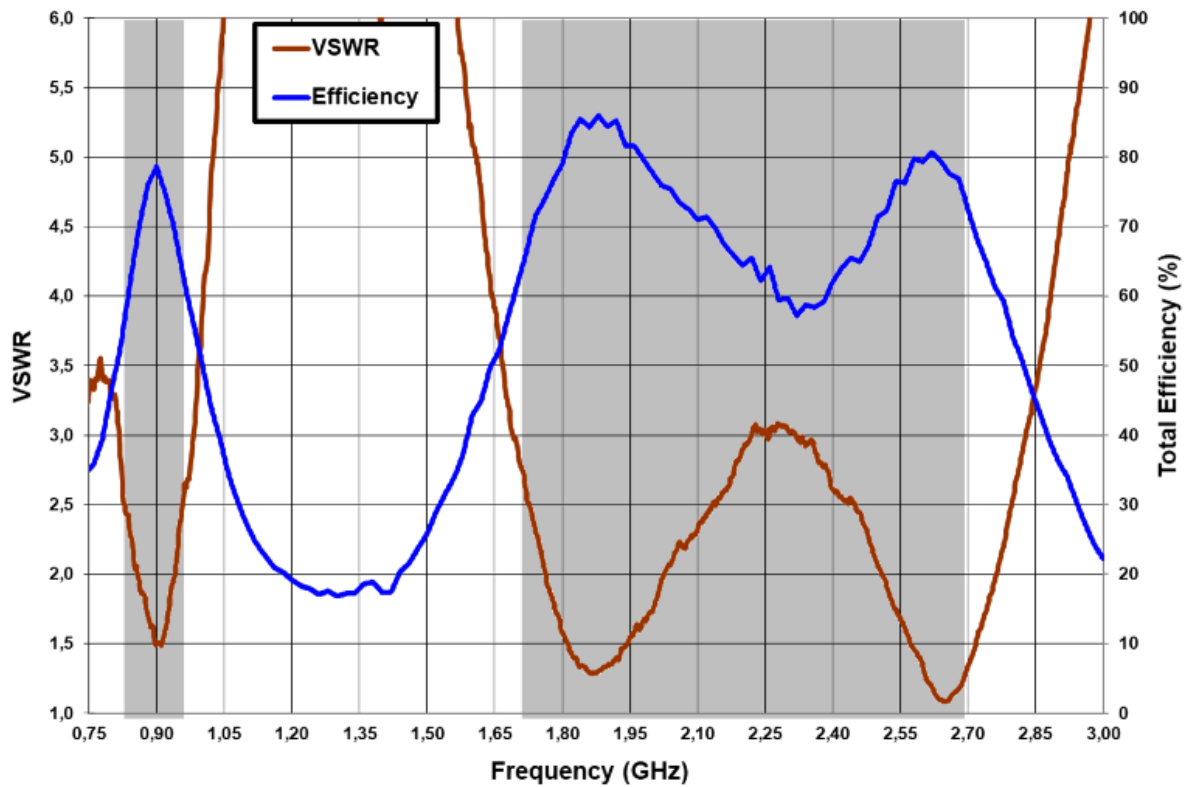
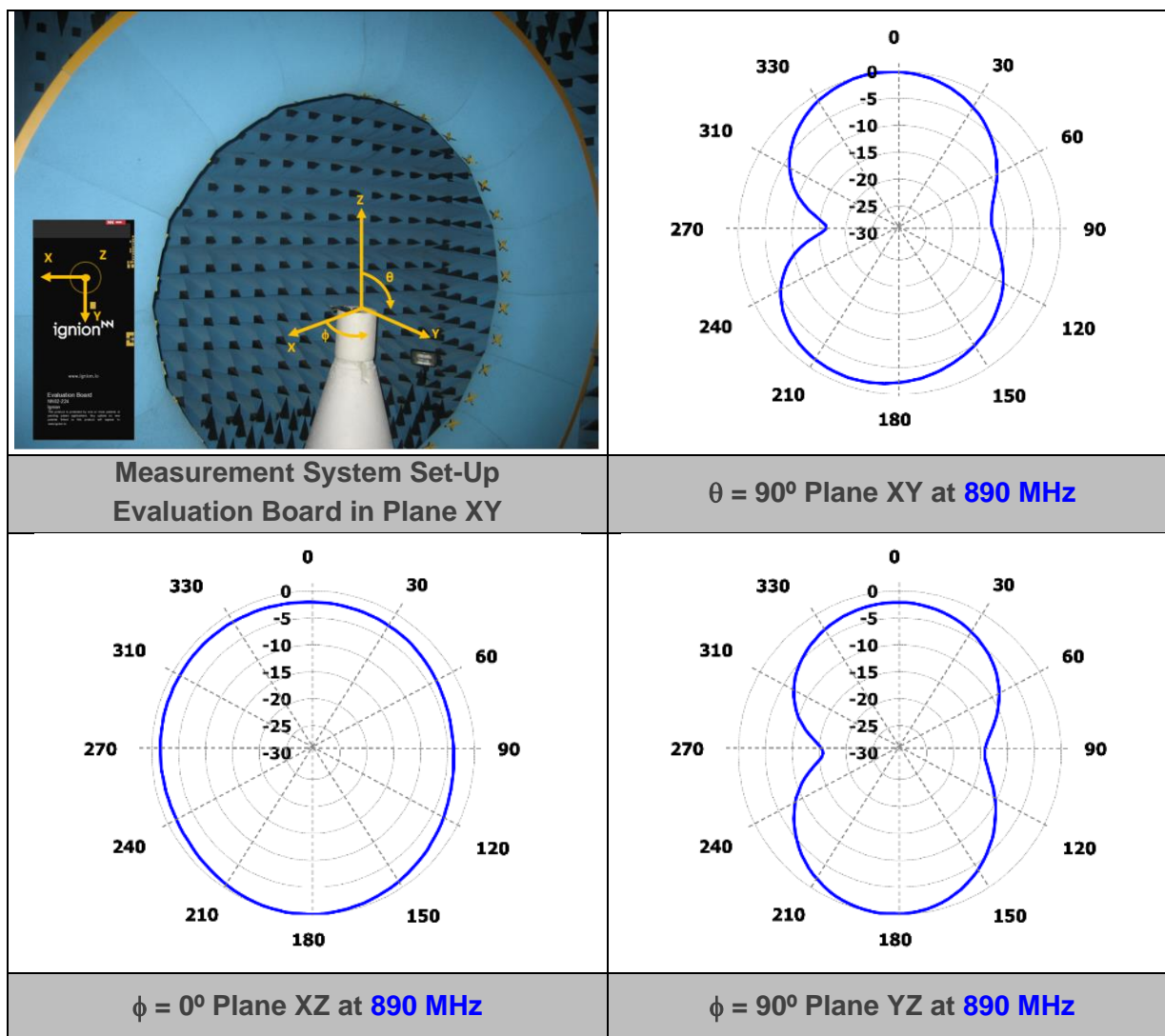

Figure 3 – VSWR and Total Efficiency for the 824 – 960 MHz frequency range and for the 1710 – 2690 MHz frequency range (from the evaluation board (Figure 1)).

RADIATION PATTERNS (824-960 MHz), GAIN AND EFFICIENCY



Gain	Peak Gain	2.8 dBi
	Average Gain across the band	1.9 dBi
	Gain Range across the band (min, max)	0.3 \leftrightarrow 2.8 dBi
Efficiency	Peak Efficiency	78.6 %
	Average Efficiency across the band	69.9 %
	Efficiency Range across the band (min, max)	54.3 – 78.6 %

Table 2 – Antenna Gain and Total Efficiency from the Evaluation Board (Figure 1) within the 824 – 960 MHz frequency range. Measures made in the Satimo STARGATE 32 anechoic chamber.

RADIATION PATTERNS (1710-2690 MHz), GAIN AND EFFICIENCY

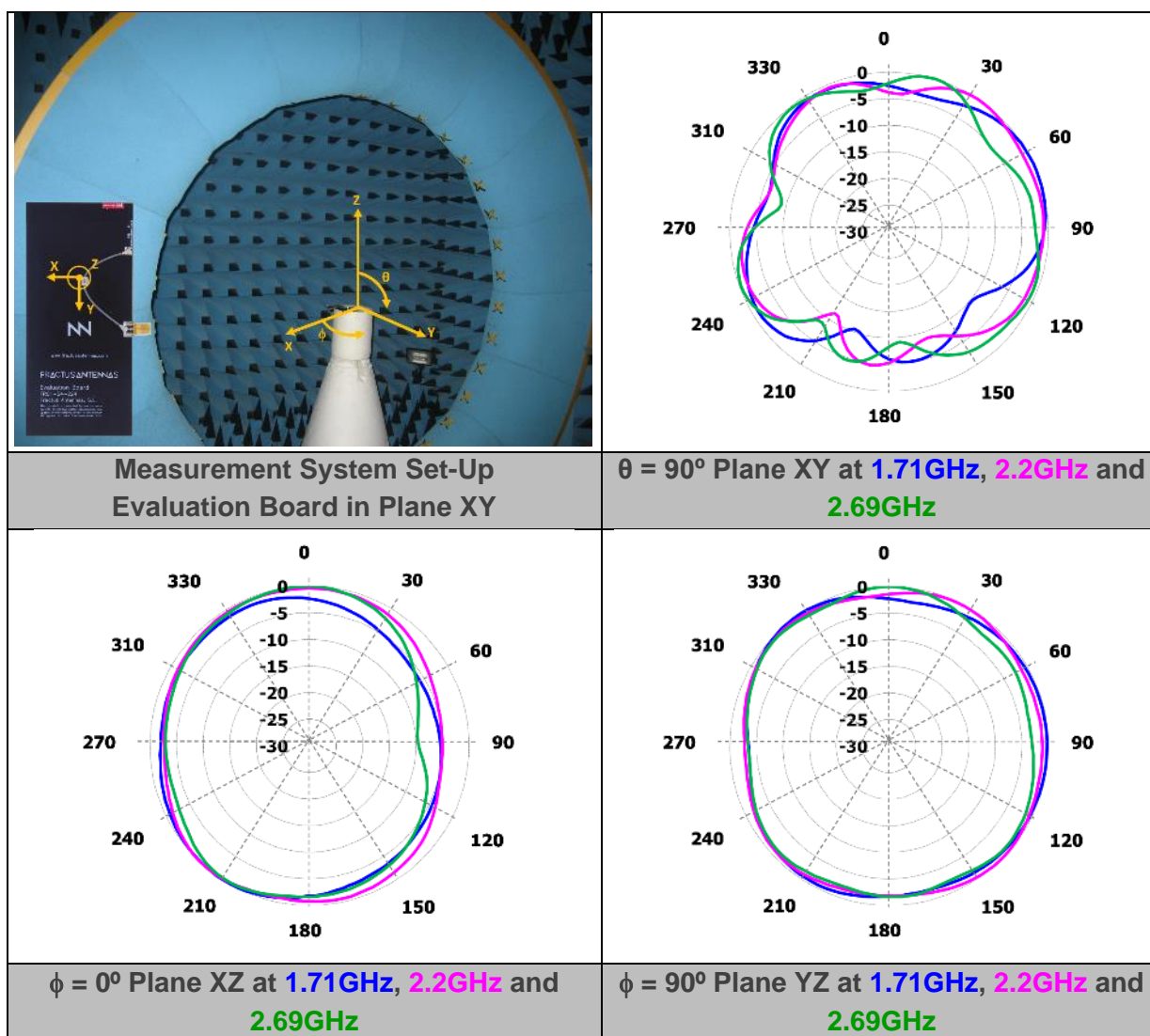

Gain	Peak Gain	1.8 dBi
	Average Gain across the band	1.1 dBi
	Gain Range across the band (min, max)	-0.2 \leftrightarrow 1.8 dBi
Efficiency	Peak Efficiency	86.0 %
	Average Efficiency across the band	72.3 %
	Efficiency Range across the band (min, max)	57.2 – 86.0 %

Table 3 – Antenna Gain and Total Efficiency from the Evaluation Board (Figure 1) within the 1710 – 2690 MHz frequency range. Measures made in the Satimo STARGATE 32 anechoic chamber.

RUN mXTEND™ for GNSS

With more than **80% of efficiency**, the new **RUN mXTEND™** chip antenna component covers operation in three frequency regions: **1561 MHz** (BeiDou E1 band), **1575 MHz** (GPS L1 band) and from **1598 MHz to 1606 MHz** (GLONASS L1 band).

Using two different sized Evaluation Boards (126.5 x 60 mm and CR80), an example of two common RUN mXTEND™ placements are shown here. Finally, two different matching networks are selected depending on PCB size, allowing us to test, obtain, and analyze the VSWR, total efficiency, gain and radiation patterns and compare the results between the two different sized applications.

QUICK REFERENCE GUIDE

Technical features	1561 MHz	1575 MHz	1598 – 1606 MHz
Average Efficiency	> 75 %		> 80 %
Peak Gain	2.9 dBi	3.0 dBi	3.3 dBi
VSWR	< 1.5:1		
Radiation Pattern	Omnidirectional		
Polarization	Linear		
Weight (approx.)	0.19 g		
Temperature	-40 to +125 °C		
Impedance	50 Ω		
Dimensions (L x W x H)	12.0 mm x 3.0 mm x 2.4 mm		

Table 4 – Technical Features. Measures from the Evaluation Board. See Figure 4.

EVALUATION BOARD

This Evaluation Board EB_NN02-224-1561-1606 integrates a UFL cable to connect the RUN mXTEND™ antenna booster with the SMA connector. The RUN mXTEND™ provides operation in three frequency regions, 1561MHz (BeiDou E1 band), 1575 MHz (GPS L1 band) and from 1598 MHz to 1606 MHz (GLONASS L1 band), through a single input/output port.

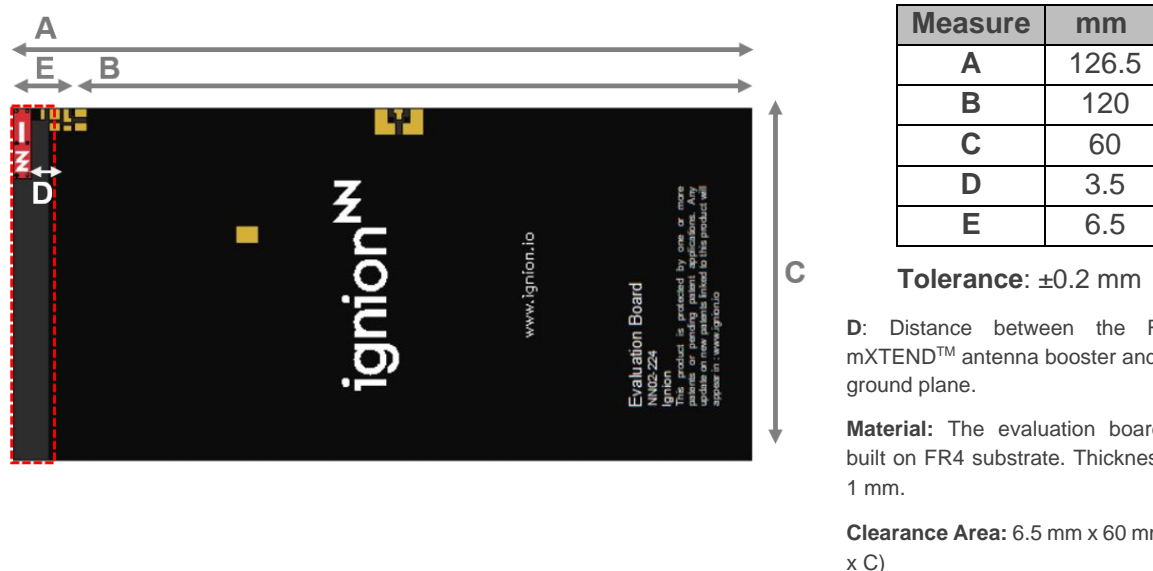

Figure 4 EB_NN02-224-1561-1606. Evaluation Board providing operation at BeiDou E1 band (1561 MHz), GPS L1 band (1575 MHz) and for GLONASS L1 band (from 1598 MHz to 1606 MHz).

This product and its use are protected by at least one or more of the following [patents](#) PAT. US 9,130,259 B2; PAT. US 8,237,615 B2. Other domestic and international patents pending. Additional information about patents related to this product is available at www.ignion.io/virtual-antenna/.

MATCHING NETWORK

The specs of a Ignion standard product are measured in their evaluation board, which is an ideal case. In a real design, components nearby the antenna, LCD's, batteries, covers, connectors, etc. might affect the antenna performance. To optimize the antenna performance, it is highly recommended placing pads compatible with 0402 and 0603 SMD components for a matching network as close as possible to the feeding point. Do it in the ground plane area, not in the clearance area. This provides a degree of freedom to tune the RUN mXTEND™ antenna booster once the design is finished and taking into account all elements of the system (batteries, displays, covers, etc.).

Please notice that different devices with different ground planes and different components nearby the RUN mXTEND™ antenna booster may need a different matching network. To ensure optimal results, the use of high Q and tight tolerance components is highly recommended (e.g. Murata components). Please, if you need assistance contact support@ignion.io for more information related to the antenna booster matching service.

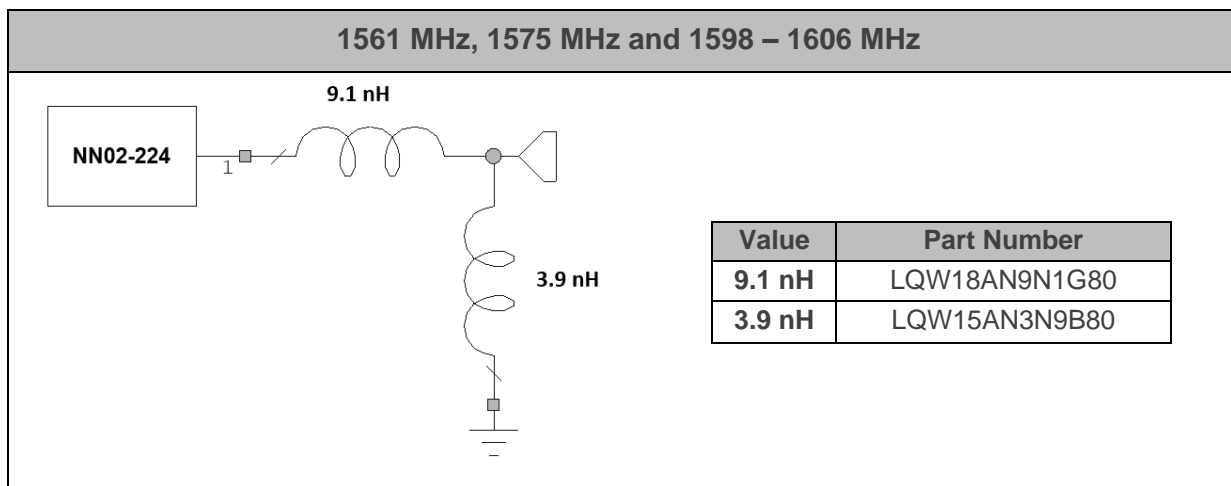

Figure 5 Matching Network implemented in the evaluation board (**Figure 4**).

If you need assistance to design your matching network, please contact support@ignion.io, or try our free-of-charge¹ **NN Wireless Fast-Track** design service, you will get your chip antenna design including a custom matching network for your device in 24h². Other related to NN's range of R&D services is available at: <https://www.ignion.io/rdservices/>

² See terms and conditions for a free NN Wireless Fast-Track service in 24h at: <https://www.ignion.io/fast-track-project/>

VSWR AND TOTAL EFFICIENCY

VSWR (Voltage Standing Wave Ratio) and Total Efficiency versus Frequency (GHz).

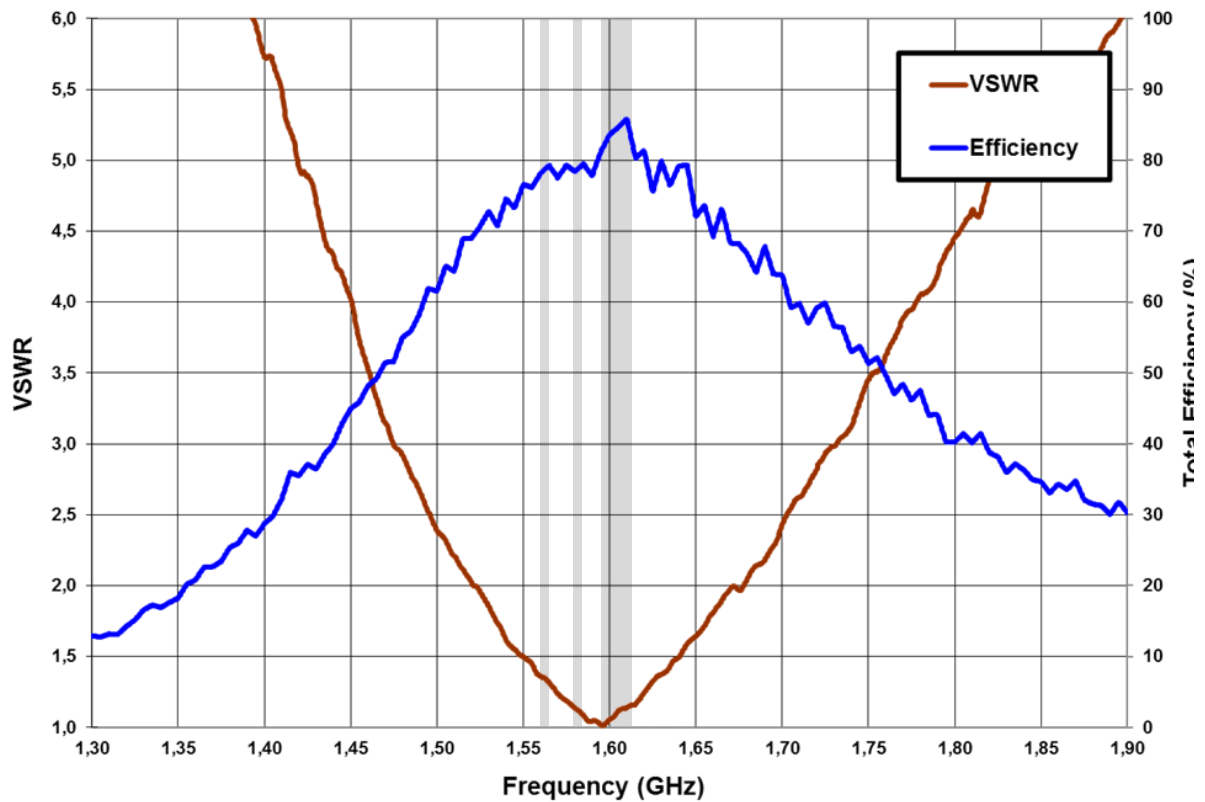
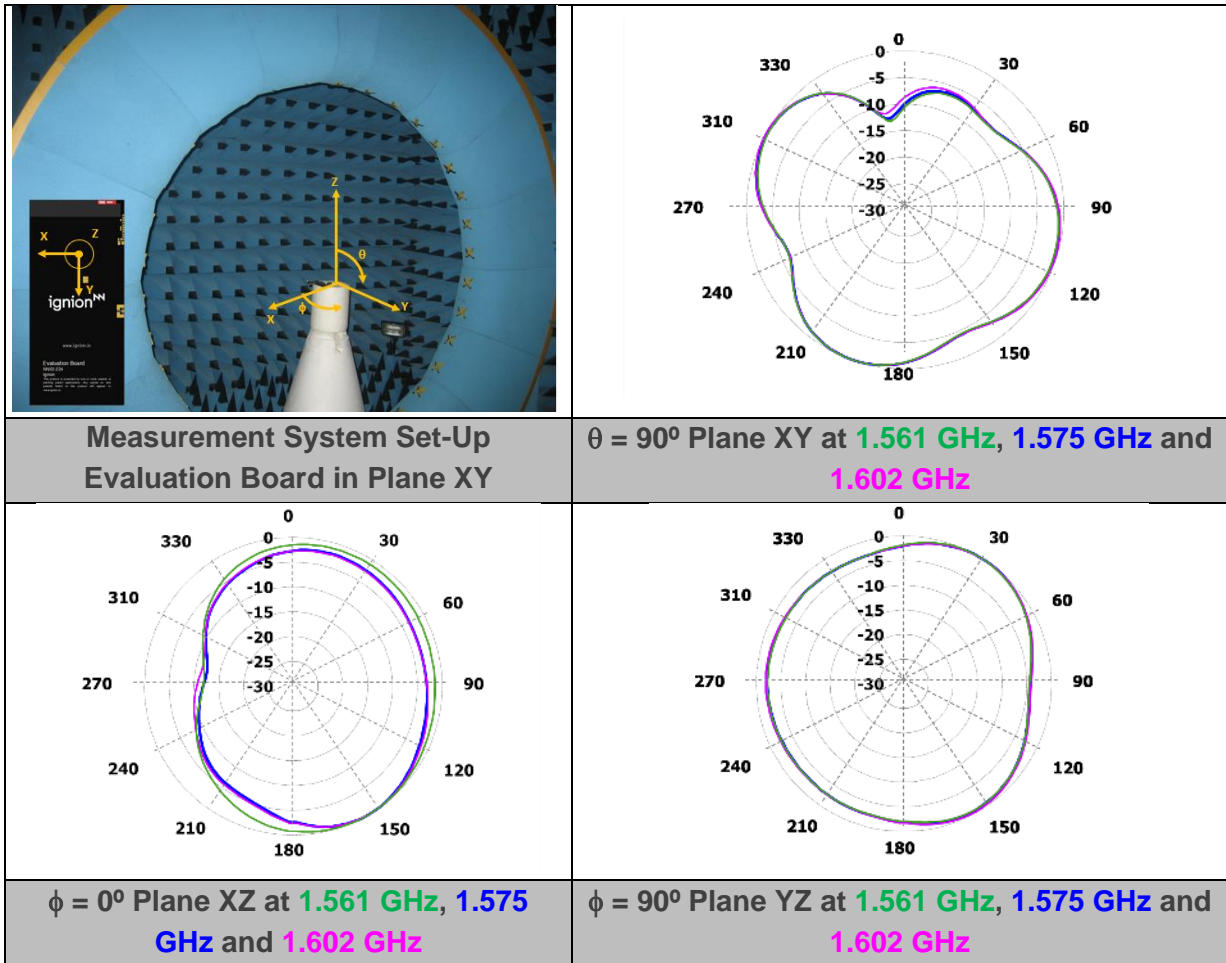

Figure 6 VSWR and Total Efficiency for BeiDou E1 band (1561 MHz), GPS L1 band (1575 MHz) and GLONASS L1 band (1598 – 1606 MHz) (from the evaluation board (**Figure 4**)).

RADIATION PATTERNS (1561, 1575 and 1598-1606 MHz), GAIN AND EFFICIENCY



BeiDou	Gain		2.9 dBi
	Efficiency		78.4%
GPS	Gain		3.0 dBi
	Efficiency		79.3 %
GLONASS	Gain	Peak Gain	3.3 dBi
		Average Gain across the band	3.2 dBi
		Gain Range across the band (min, max)	3.1 ↔ 3.3 dBi
	Efficiency	Peak Efficiency	84.9 %
		Average Efficiency across the band	83.8 %
		Efficiency Range across the band (min, max)	82.7 – 84.9 %

Table 5 – Antenna Gain and Total Efficiency from the evaluation board (Figure 4) for BeiDou E1 (1561 MHz), GPS L1 (1575 MHz) and GLONASS L1 (1598 – 1606 MHz) bands. Measures made in the Satimo STARGATE 32 anechoic chamber.

EVALUATION BOARD CR80 GPS/GLONASS/BeiDou

QUICK REFERENCE GUIDE

Technical features	1561 MHz	1575 MHz	1598 – 1606 MHz
Average Efficiency	> 80 %		> 85 %
Peak Gain	3.1 dBi	3.3 dBi	3.6 dBi
VSWR	< 1.5:1		
Radiation Pattern	Omnidirectional		
Polarization	Linear		
Weight (approx.)	0.19 g		
Temperature	-40 to +125 °C		
Impedance	50 Ω		
Dimensions (L x W x H)	12.0 mm x 3.0 mm x 2.4 mm		

Table 6 – Technical Features. Measures from the Evaluation Board. See Figure 7.

EVALUATION BOARD

This Evaluation Board EB_NN02-224-CR80-1561-1606 integrates a UFL cable to connect the RUN mXTEND™ antenna booster with the SMA connector. The RUN mXTEND™ provides operation in three frequency regions, 1561 MHz (BeiDou E1 band), 1575 MHz (GPS L1 band) and from 1598 MHz to 1606 MHz (GLONASS L1 band), through a single input/output port.

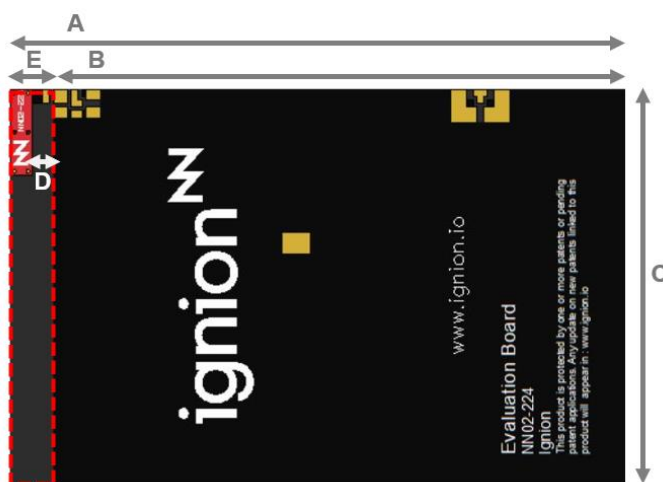

Measure	mm
A	86
B	79.5
C	54
D	3.5
E	6.5

Tolerance: ±0.2 mm

D: Distance between the RUN mXTEND™ antenna booster and the ground plane.

Material: The evaluation board is built on FR4 substrate. Thickness is 1 mm.

Clearance Area: 6.5 mm x 54 mm (E x C)

Figure 7 – EB_NN02-224-CR80-1561-1606 in CR80 standard format. Evaluation Board providing operation for BeiDou E1 band (1561 MHz), GPS L1 band (1575 MHz) and for GLONASS L1 band (from 1598 MHz to 1606 MHz).

This product and its use are protected by at least one or more of the following [patents](#) PAT. US 9,130,259 B2; PAT. US 8,237,615 B2. Other domestic and international patents pending. Additional information about patents related to this product is available at www.ignion.io/virtual-antenna/.

MATCHING NETWORK

The specs of a Ignion standard product are measured in their evaluation board, which is an ideal case. In a real design, components nearby the antenna, LCD's, batteries, covers, connectors, etc. affect the antenna performance. This is the reason why it is highly recommended placing pads compatible with 0402 and 0603 SMD components for a matching network as close as possible to the feeding point. Do it in the ground plane area, not in the clearance area. This provides a degree of freedom to tune the RUN mXTEND™ antenna booster once the design is finished and taking into account all elements of the series (batteries, displays, covers, etc.).

Please notice that different devices with different ground planes and different components nearby the RUN mXTEND™ antenna booster may need a different matching network. To ensure optimal results, the use of high Q and tight tolerance components is highly recommended (Murata components). Please, if you need assistance contact support@ignion.io for more information related to the antenna booster matching service.

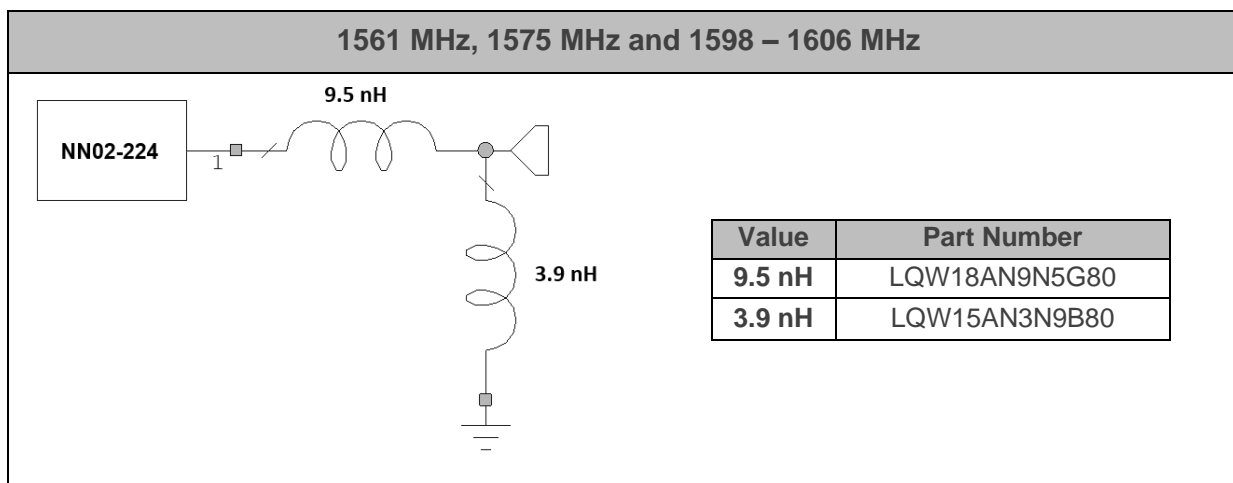

Figure 8 – Matching Network implemented in the evaluation board (**Figure 7**).

If you need assistance to design your matching network, please contact support@ignion.io, or try our free-of-charge¹ **NN Wireless Fast-Track** design service, you will get your chip antenna design including a custom matching network for your device in 24h³. Other related to NN's range of R&D services is available at: <https://www.ignion.io/rdservices/>

VSWR AND TOTAL EFFICIENCY

³ See terms and conditions for a free NN Wireless Fast-Track service in 24h at: <https://www.ignion.io/fast-track-project/>

VSWR (Voltage Standing Wave Ratio) and Total Efficiency versus Frequency (GHz).

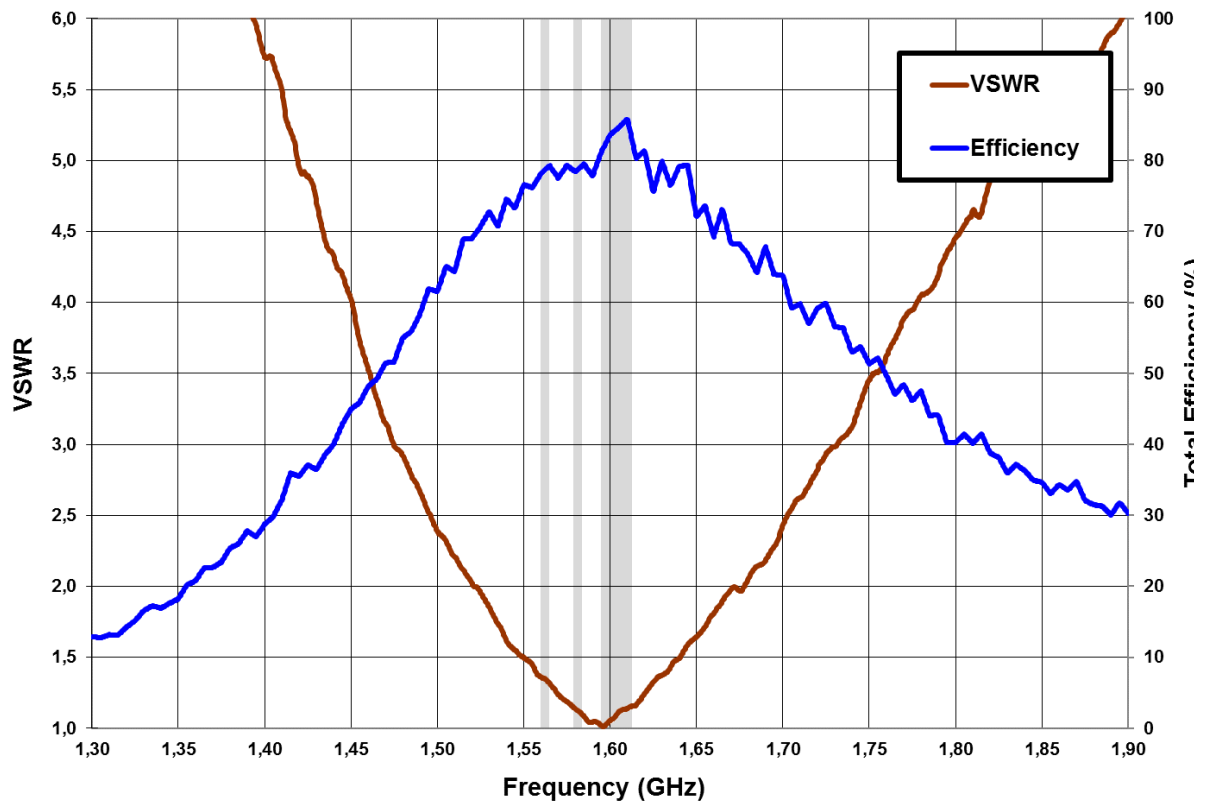
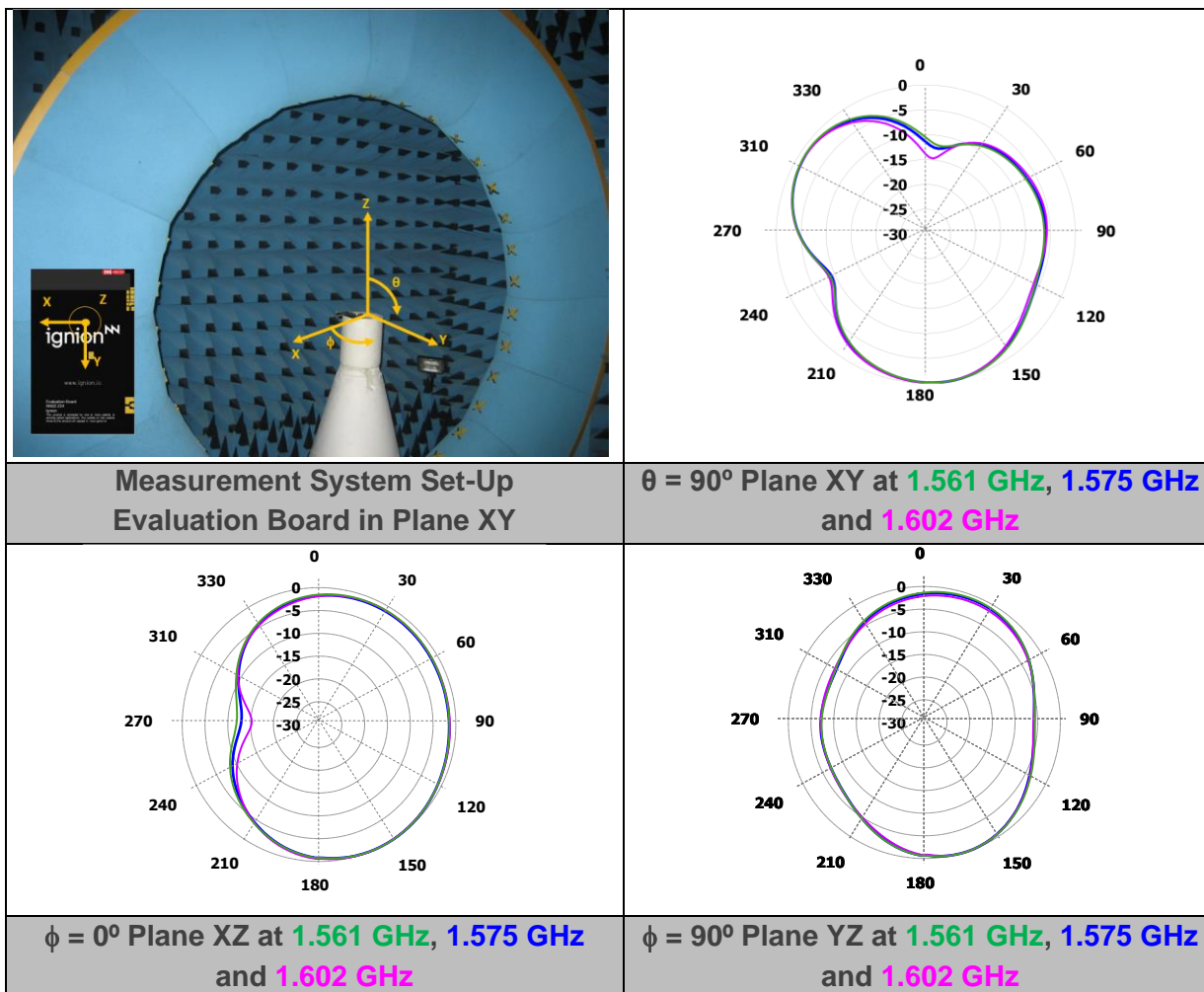

Figure 9 – VSWR and Total Efficiency for BeiDou E1 (1561 MHz), GPS L1 band (1575 MHz) and GLONASS L1 band (1598 – 1606 MHz) (from the evaluation board (Figure 7)).

RADIATION PATTERNS (1561, 1575, and 1598-1606 MHz), GAIN AND EFFICIENCY



BeiDou		Gain	3.1 dBi
		Efficiency	84.7 %
GPS		Gain	3.3 dBi
		Efficiency	84.9 %
GLONASS	Gain	Peak Gain	3.6 dBi
		Average Gain across the band	3.5 dBi
		Gain Range across the band (min, max)	3.4 <-> 3.6 dBi
	Efficiency	Peak Efficiency	88.7 %
		Average Efficiency across the band	87.6 %
		Efficiency Range across the band (min, max)	86.4 – 88.7 %

Table 7 – Antenna Gain and Total Efficiency from the evaluation board (Figure 7) for BeiDou E1 (1561 MHz), GPS L1 (1575 MHz) and GLONASS L1 (1598 – 1606 MHz) bands. Measures made in the Satimo STARGATE 32 anechoic chamber.

RUN mXTEND[™] for Bluetooth/Wi-Fi

The RUN mXTEND[™] antenna booster has been specifically designed for providing multiband performance across a wide variety of wireless devices, enabling worldwide cellular coverage but also allowing operation in ISM communication standards including Bluetooth and WIFI.

Using two different sized Evaluation Boards (126.5 x 60 mm and CR80), an example of two common RUN mXTEND[™] placements are seen. Finally, two different matching networks are selected depending on PCB size, allowing us to test, obtain, and analyze the VSWR, total efficiency, gain and radiation patterns and compare the results between the two different sized applications.

EVALUATION BOARD (126.5 x 60 mm)

QUICK REFERENCE GUIDE

Technical features	2.4 – 2.5 GHz
Average Efficiency	> 75 %
Peak Gain	4.2 dBi
VSWR	< 1.5:1
Radiation Pattern	Omnidirectional
Polarization	Linear
Weight (approx.)	0.19 g
Temperature	-40 to +125 °C
Impedance	50 Ω
Dimensions (L x W x H)	12.0 mm x 3.0 mm x 2.4 mm

Table 8 – Technical Features. Measures from the Evaluation Board. See **Figure 10**.

EVALUATION BOARD

This Evaluation Board EB_NN02-224-2400 integrates a UFL cable to connect the RUN mXTEND™ antenna booster with the SMA connector. The RUN mXTEND™ provides operation in the frequency region which covers from 2.4 GHz to 2.5 GHz, through a single input/output port.

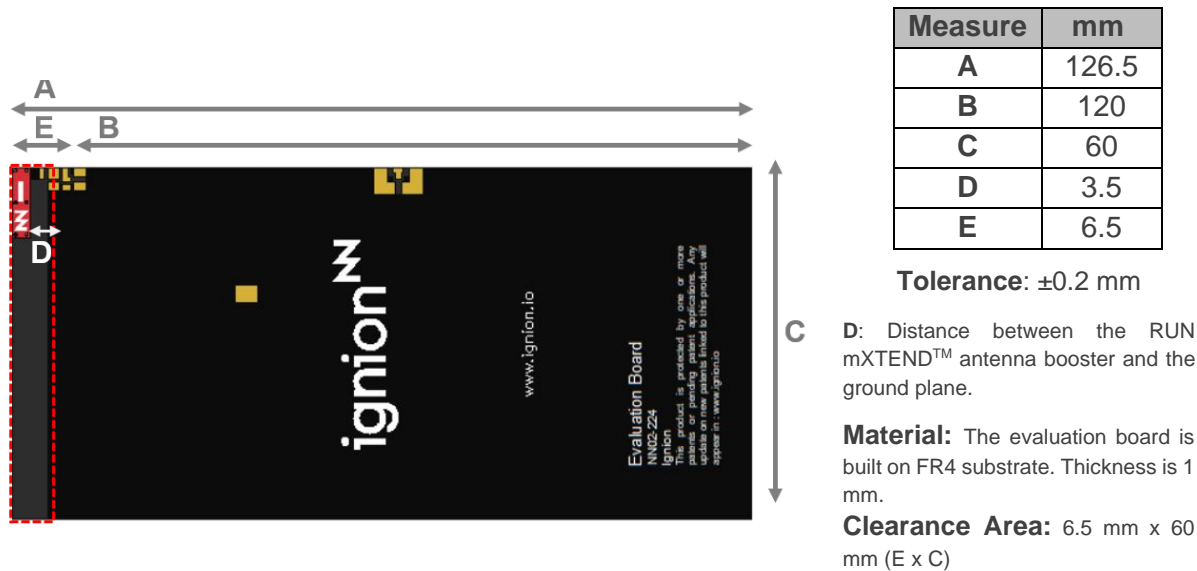

Figure 10 – EB_NN02-224-2400. Evaluation Board providing operation from 2.4 GHz to 2.5 GHz.

This product and its use are protected by at least one or more of the following [patent](#) PAT. US 9,130,259 B2. Other domestic and international patents pending. Additional information about patents related to this product is available at www.ignion.io/virtual-antenna/.

MATCHING NETWORK

The specs of a Ignion standard product are measured in their evaluation board, which is an ideal case. In a real design, components nearby the antenna, LCD's, batteries, covers, connectors, etc. might affect the antenna performance. To optimize the antenna performance it is highly recommended placing pads compatible with 0402 and 0603 SMD components for a matching network as close as possible to the feeding point. Do it in the ground plane area, not in the clearance area. This provides a degree of freedom to tune the RUN mXTEND™ antenna booster once the design is finished and considering all elements of the series (batteries, displays, covers, etc.).

Please notice that different devices with different ground planes and different components nearby the RUN mXTEND™ antenna booster may need a different matching network. To ensure optimal results, the use of high Q and tight tolerance components is highly recommended (Murata components). Please, if you need assistance contact support@ignion.io for more information related to the antenna booster matching service.

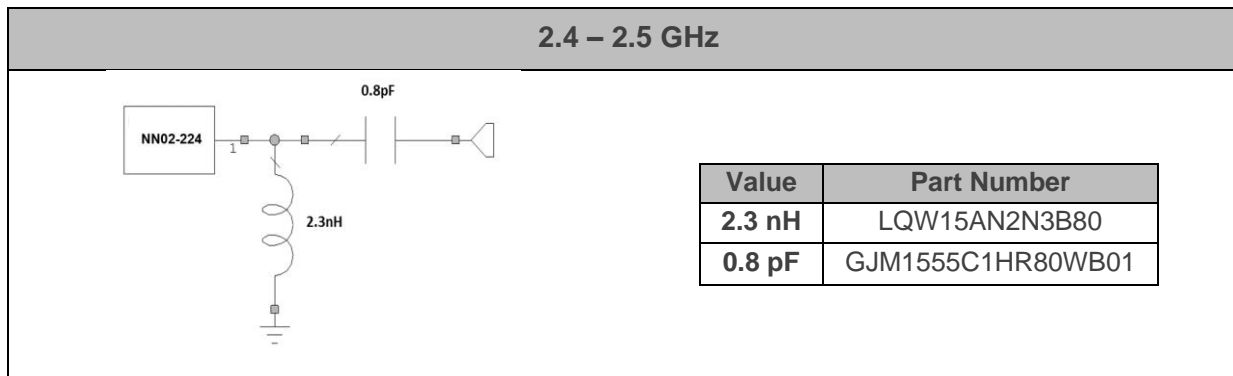

Figure 11 – Matching Network implemented in the evaluation board (Figure 10).

For additional information, please visit www.ignion.io or contact info@ignion.io.

If you need assistance to design your matching network, please contact support@ignion.io, or try our free-of-charge¹ **NN Wireless Fast-Track** design service, you will get your chip antenna design including a custom matching network for your device in 24h⁴. Other related to NN's range of R&D services is available at: <https://www.ignion.io/rdservices/>

⁴ See terms and conditions for a free NN Wireless Fast-Track service in 24h at: <https://www.ignion.io/fast-track-project/>

VSWR AND TOTAL EFFICIENCY

VSWR (Voltage Standing Wave Ratio) and Total Efficiency versus Frequency (GHz).

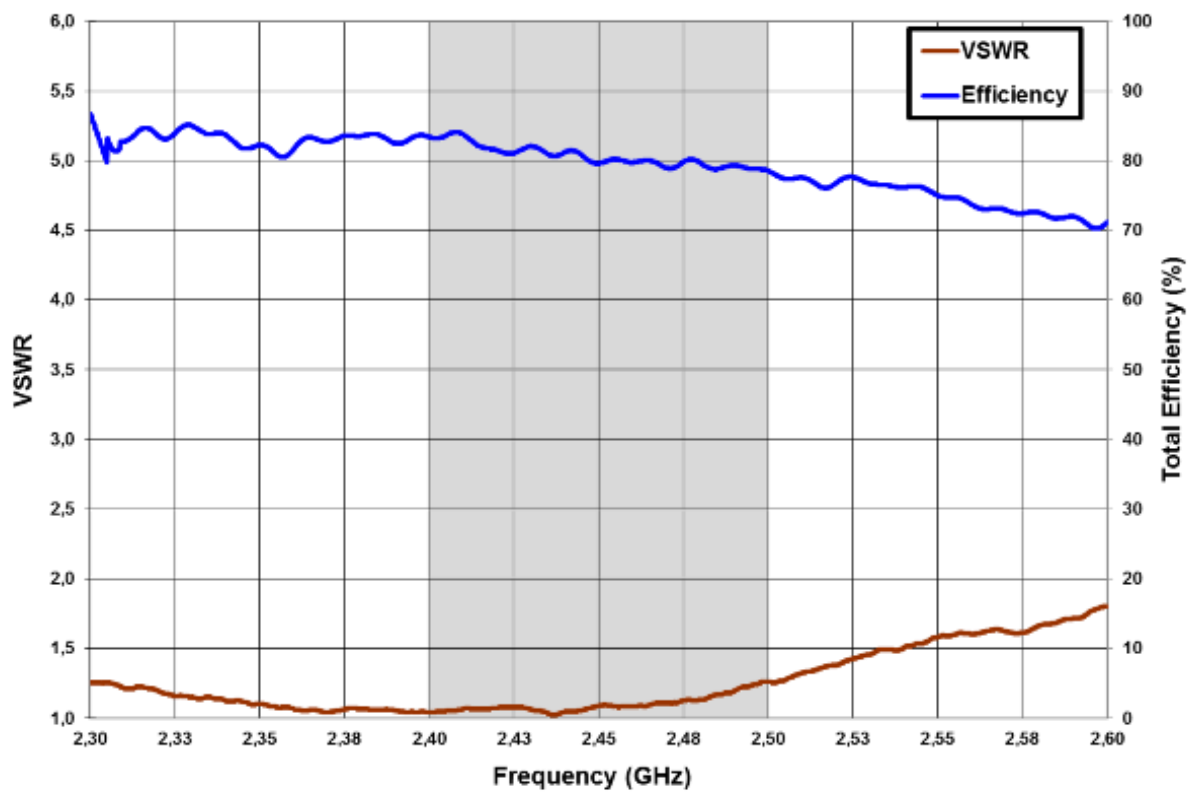
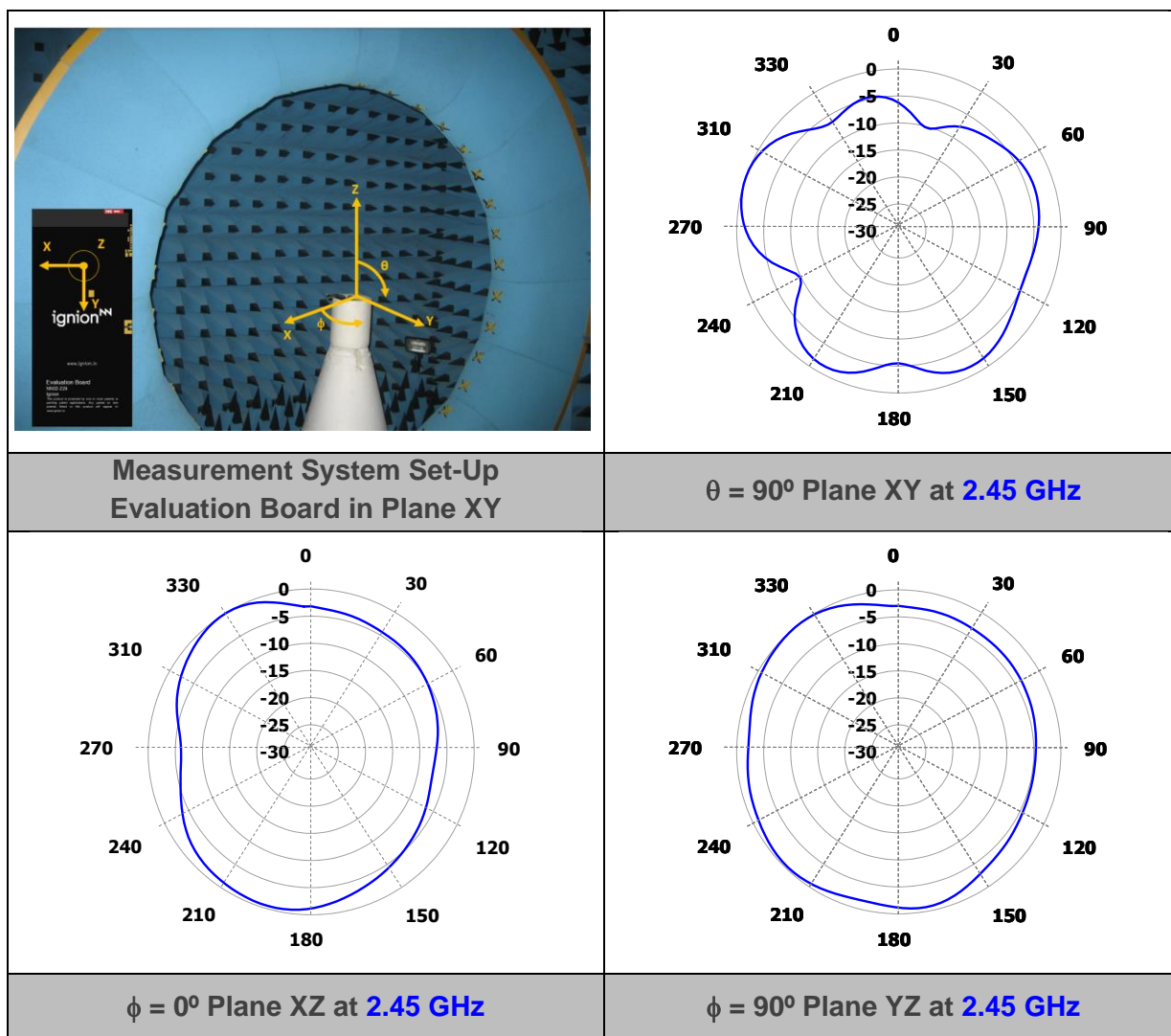

Figure 12 – VSWR and Total Efficiency for the 2.4 – 2.5 GHz frequency range (from the evaluation board (Figure 10)).

RADIATION PATTERNS (2.4-2.5 GHz), GAIN AND EFFICIENCY



Gain	Peak Gain	4.2 dBi
	Average Gain across the band	3.9 dBi
	Gain Range across the band (min, max)	3.6 \leftrightarrow 4.2 dBi
Efficiency	Peak Efficiency	86.0 %
	Average Efficiency across the band	80.4 %
	Efficiency Range across the band (min, max)	75.7 – 86.0 %

Table 9 – Antenna Gain and Total Efficiency from the Evaluation Board (Figure 10) within the 2.4 – 2.5 GHz frequency range. Measures made in the Satimo STARGATE 32 anechoic chamber.

EVALUATION BOARD (CR80) QUICK REFERENCE GUIDE

Technical features	2.4 – 2.5 GHz
Average Efficiency	> 70 %
Peak Gain	3.0 dBi
VSWR	< 1.5:1
Radiation Pattern	Omnidirectional
Polarization	Linear
Weight (29 approx.)	0.19 g
Temperature	-40 to +125 °C
Impedance	50 Ω
Dimensions (L x W x H)	12.0 mm x 3.0 mm x 2.4 mm

Table 10 – Technical Features. Measures from the Evaluation Board. See Figure 13.

EVALUATION BOARD

This Evaluation Board EB_NN02-224-CR80-2400 integrates a UFL cable to connect the RUN mXTEND™ antenna booster with the SMA connector. The RUN mXTEND™ provides operation in the frequency region which covers from 2.4 GHz to 2.5 GHz, through a single input/output port.



Measure	mm
A	86
B	79.5
C	54
D	2.5
E	6.5

Tolerance: ±0.2 mm

D: Distance between the RUN mXTEND™ antenna booster and the ground plane.

Material: The evaluation board is built on FR4 substrate. Thickness is 1 mm.

Clearance Area: 6.5 mm x 54 mm (E x C)

Figure 13 – EB_NN02-224-CR80-2400 in CR80 standard format. Evaluation Board providing operation from 2.4 GHz to 2.5 GHz.

This product and its use are protected by at least the following [patent](#): PAT. US 9,130,259 B2. Other domestic and international patents pending. Additional information about patents related to this product is available at www.ignion.io/virtual-antenna/.

MATCHING NETWORK

The specs of a Ignion standard product are measured in their evaluation board, which is an ideal case. In a real design, components nearby the antenna, LCD's, batteries, covers, connectors, etc. affect the antenna performance. This is the reason why it is highly recommended placing pads compatible with 0402 and 0603 SMD components for a matching network as close as possible to the feeding point. Do it in the ground plane area, not in the clearance area. This provides a degree of freedom to tune the RUN mXTEND™ antenna booster once the design is finished and considering all elements of the system (batteries, displays, covers, etc.).

Please notice that different devices with different ground planes and different components nearby the RUN mXTEND™ antenna booster may need a different matching network. To ensure optimal results, the use of high Q and tight tolerance components is highly recommended (Murata components). Please, if you need assistance contact support@ignion.io for more information related to the antenna booster matching service.

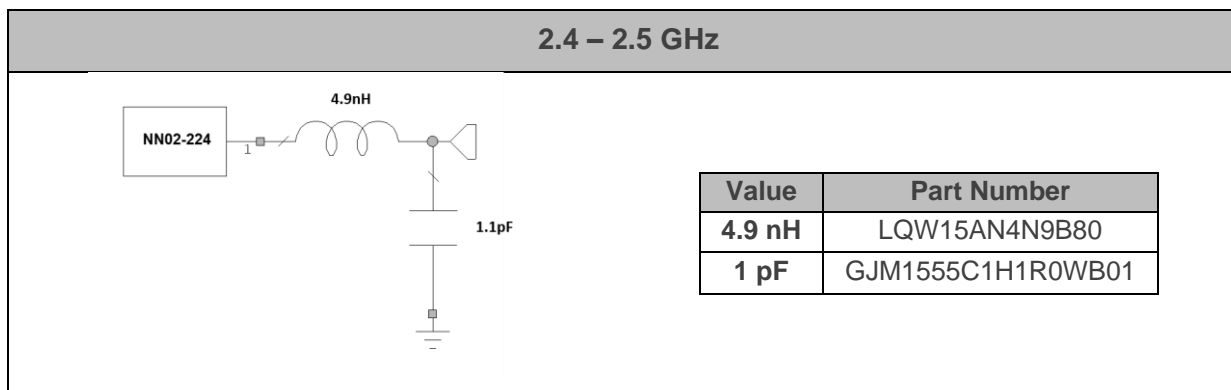

Figure 14 – Matching Network implemented in the evaluation board (Figure 13).

For additional information, please visit www.ignion.io or contact info@ignion.io.

If you need assistance to design your matching network, please contact support@ignion.io, or try our free-of-charge¹ **NN Wireless Fast-Track** design service, you will get your chip antenna design including a custom matching network for your device in 24h⁵. Other related to NN's range of R&D services is available at: <https://www.ignion.io/rdservices/>

⁵ See terms and conditions for a free NN Wireless Fast-Track service in 24h at: <https://www.ignion.io/fast-track-project/>

VSWR AND TOTAL EFFICIENCY

VSWR (Voltage Standing Wave Ratio) and Total Efficiency versus Frequency (GHz).

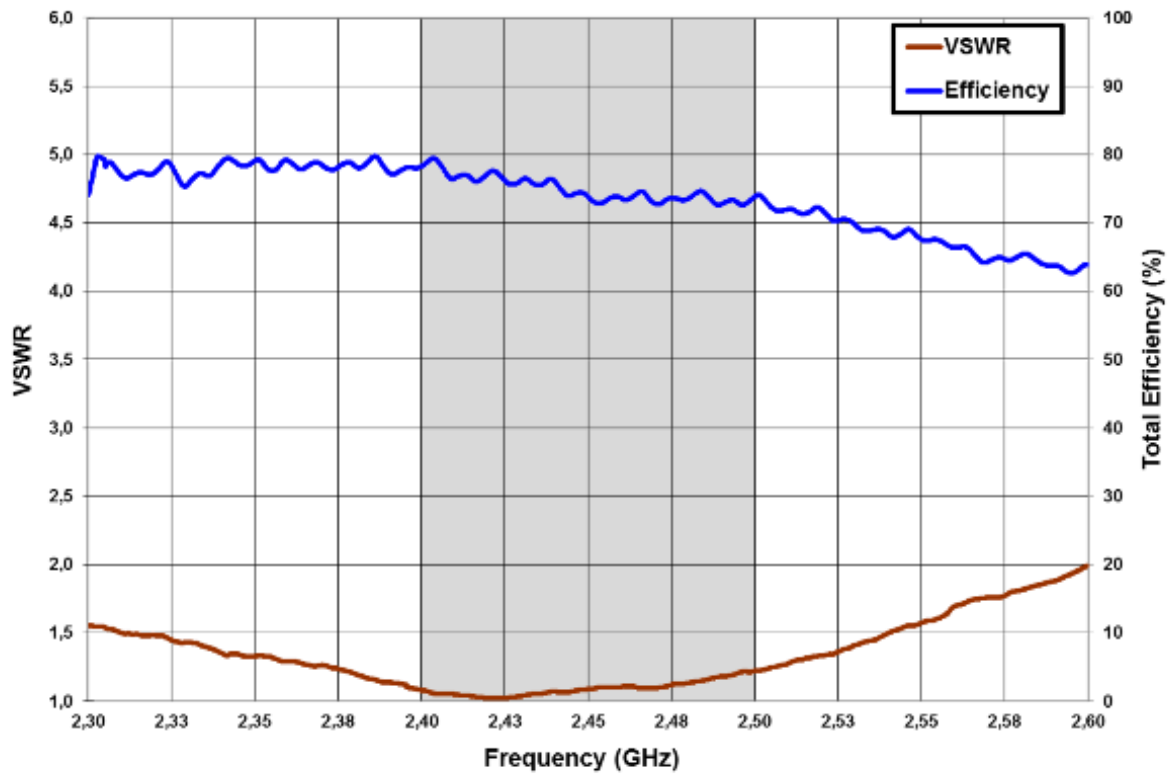
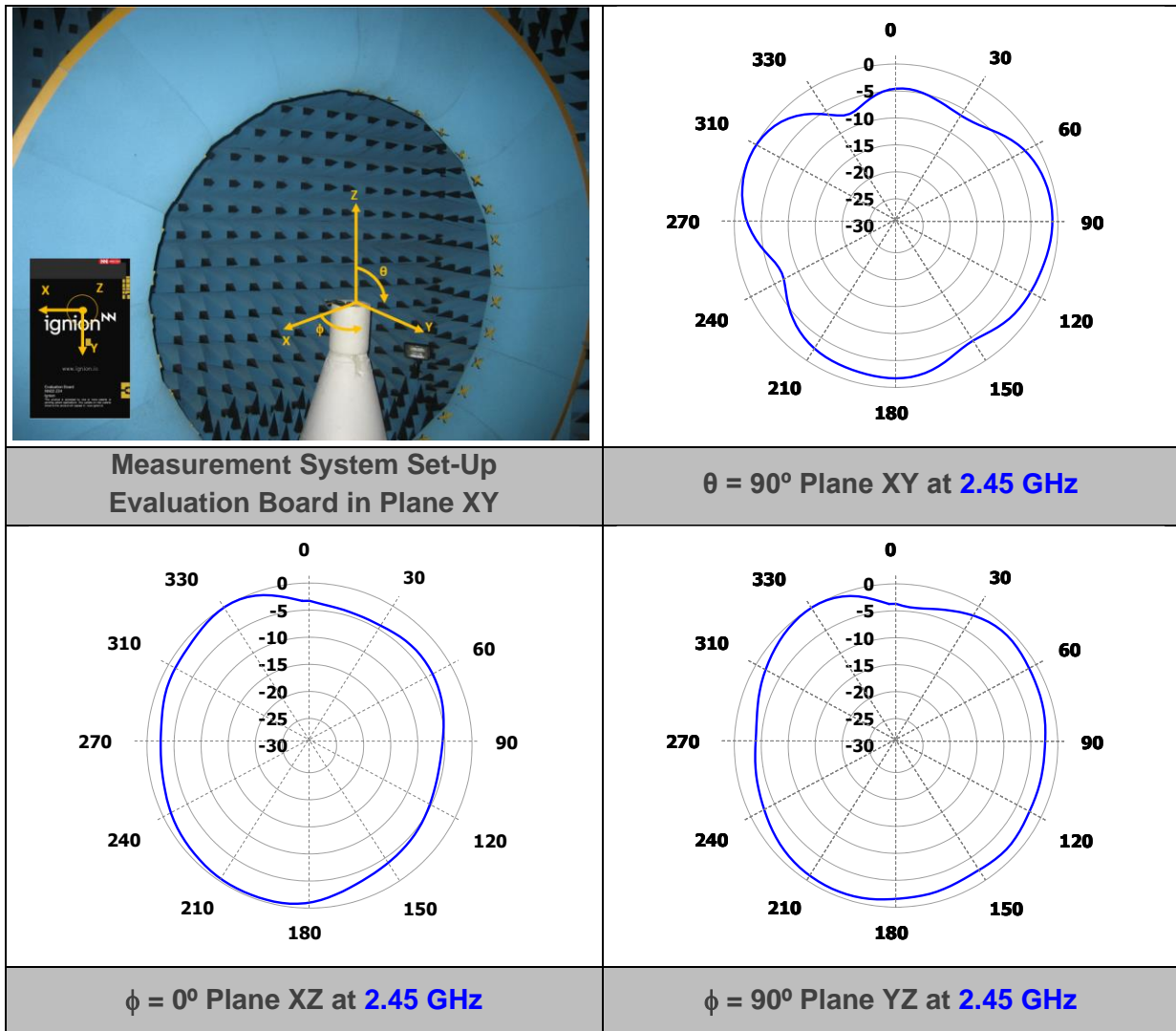

Figure 15 – VSWR and Total Efficiency for the 2.4 – 2.5 GHz frequency range (from the evaluation board (Figure 13)).

RADIATION PATTERNS (2.4-2.5 GHz), GAIN AND EFFICIENCY



Gain	Peak Gain	3.0 dBi
	Average Gain across the band	2.7 dBi
	Gain Range across the band (min, max)	2.5 \leftrightarrow 3.0 dBi
Efficiency	Peak Efficiency	79.6 %
	Average Efficiency across the band	74.8 %
	Efficiency Range across the band (min, max)	71.6 – 79.6 %

Table 11 – Antenna Gain and Total Efficiency from the Evaluation Board (**Figure 13**) within the 2.4 – 2.5 MHz frequency range. Measures made in the Satimo STARGATE 32 anechoic chamber.

MECHANICAL SPECIFICATIONS

DIMENSIONS, TOLERANCES, AND RoHS

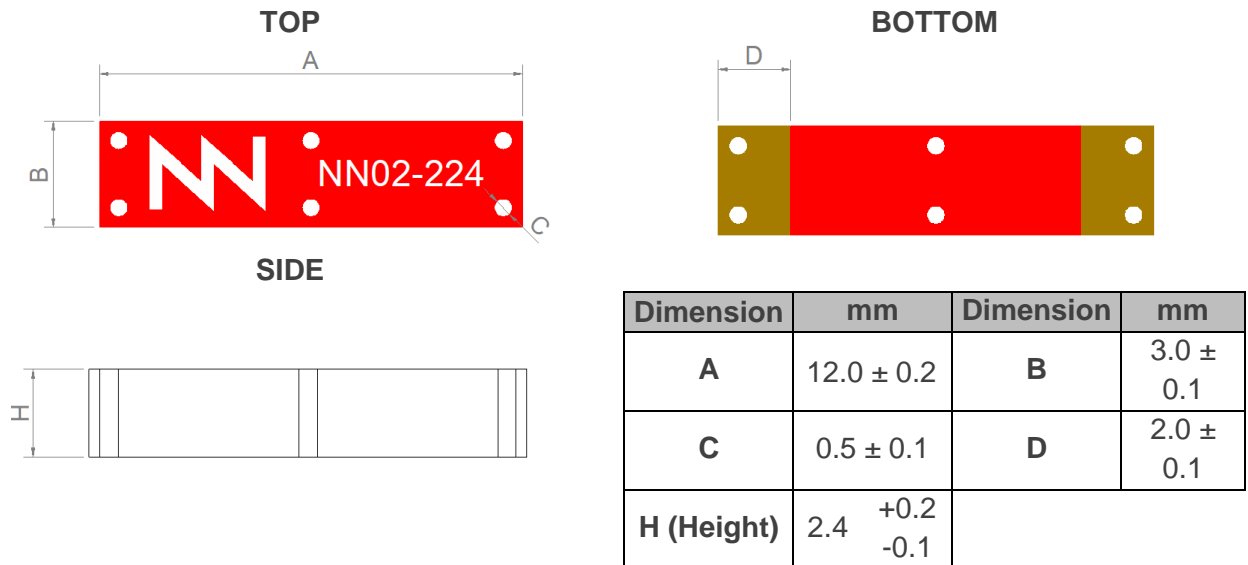

Figure 16 – RUN mXTEND™ antenna booster dimensions and tolerances.

The 2 pads are fully symmetrical to mount it on the PCB. See **Figure 16**.

The RUN mXTEND™ antenna booster NN02-224 is compliant with the restriction of the use of hazardous substances (**RoHS**).

The RoHS certificate can be downloaded from www.ignion.io.

SPECIFICATIONS FOR THE INK

The next figure shows the range of the colours in the RUN mXTEND™ antenna booster:

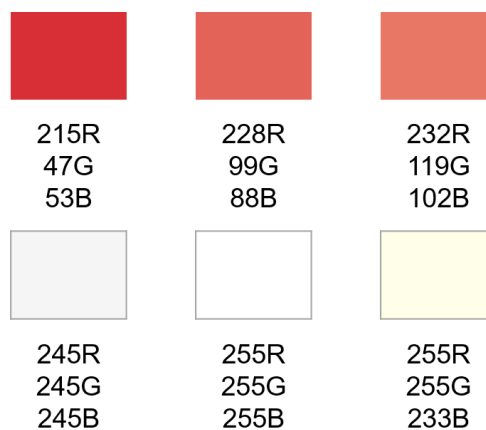

Acceptable color range

ANTENNA FOOTPRINT

Assuming that, the RUN mXTEND[™] antenna booster NN02-224 is placed in the clearance area of the PCB, see below the recommended footprint dimensions.

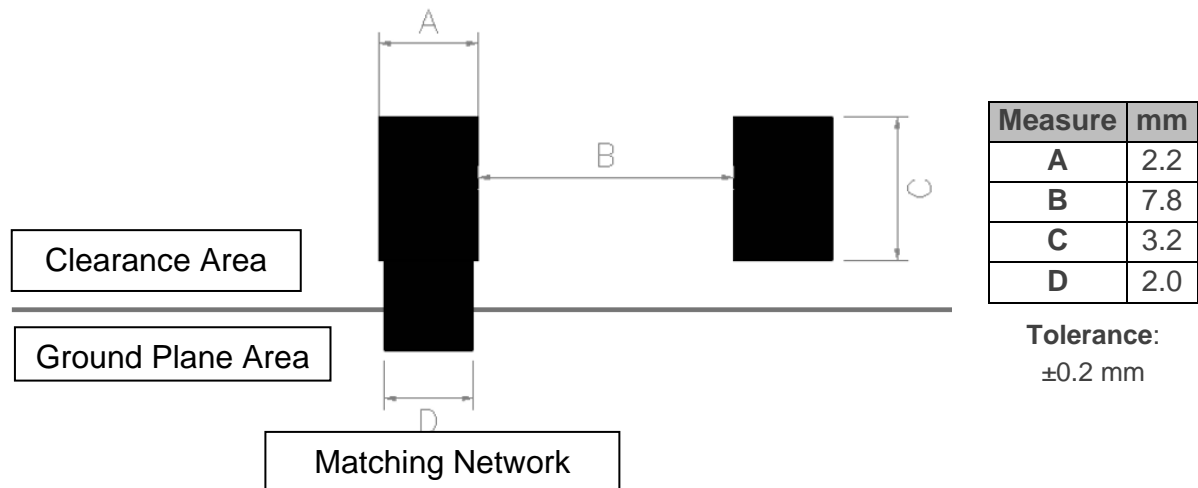

Figure 17 – Footprint dimensions for the single booster.

For additional support in the integration process, please contact support@ignion.io.

ASSEMBLY AND MANUFACTURING

Figure 18 shows the back and front view of the RUN mXTEND[™] antenna booster NN02-224. Due to the symmetry in the product configuration, the feeding pad can be any of the 2 pads.

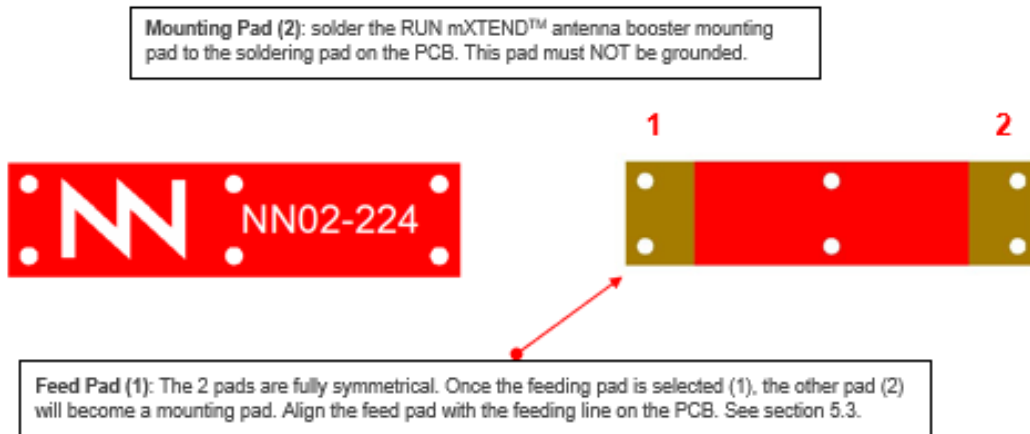

Figure 18 – Pads of the RUN mXTEND[™] antenna booster NN02-224.

As a surface mount device (SMD), the RUN mXTEND[™] antenna booster is compatible with industry standard soldering processes. The basic assembly procedure for the RUN mXTEND[™] antenna booster is as follows:

1. Apply a solder paste on the pads of the PCB. Place the RUN mXTEND[™] antenna booster on the board.
2. Perform a reflow process according to the temperature profile detailed in Table 12, **Figure 20**.
3. After soldering the RUN mXTEND[™] antenna booster to the circuit board, perform a cleaning process to remove any residual flux. Ignion recommends conducting a visual inspection after the cleaning process to verify that all reflux has been removed.

The drawing below shows the soldering details obtained after a correct assembly process:

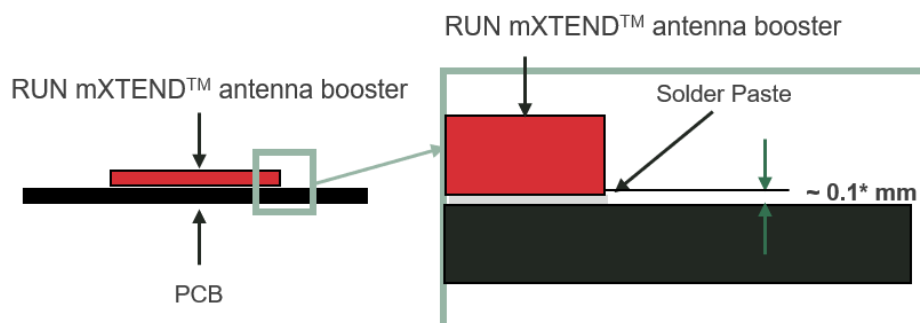

Figure 19 – Soldering Details.

NOTE(*): Solder paste thickness after the assembly process will depend on the thickness of the soldering stencil mask. A stencil thickness equal or larger than 127 microns (5 mils) is required.

The RUN mXTEND[™] antenna booster NN02-224 can be assembled following the Pb-free assembly process. According to the Standard **IPC/JEDEC J-STD-020C**, the temperature profile suggested is as follows:

Phase	Profile features	Pb-Free Assembly (SnAgCu)
RAMP-UP	Avg. Ramp-up Rate (T _{smax} to T _p)	3 °C / second (max.)
PREHEAT	- Temperature Min (T _{smin}) - Temperature Max (T _{smax}) - Time (t _{smin} to t _{smax})	150 °C 200 °C 60-180 seconds
REFLOW	- Temperature (T _L) - Total Time above T _L (t _L)	217 °C 60-150 seconds
PEAK	- Temperature (T _p) - Time (t _p)	260 °C 20-40 seconds
RAMP-DOWN	Rate	6 °C/second max
Time from 25 °C to Peak Temperature		8 minutes max

Table 12 – Recommended soldering temperatures.

Next graphic shows temperature profile (grey zone) for the RUN mXTEND[™] antenna booster assembly process reflow ovens.

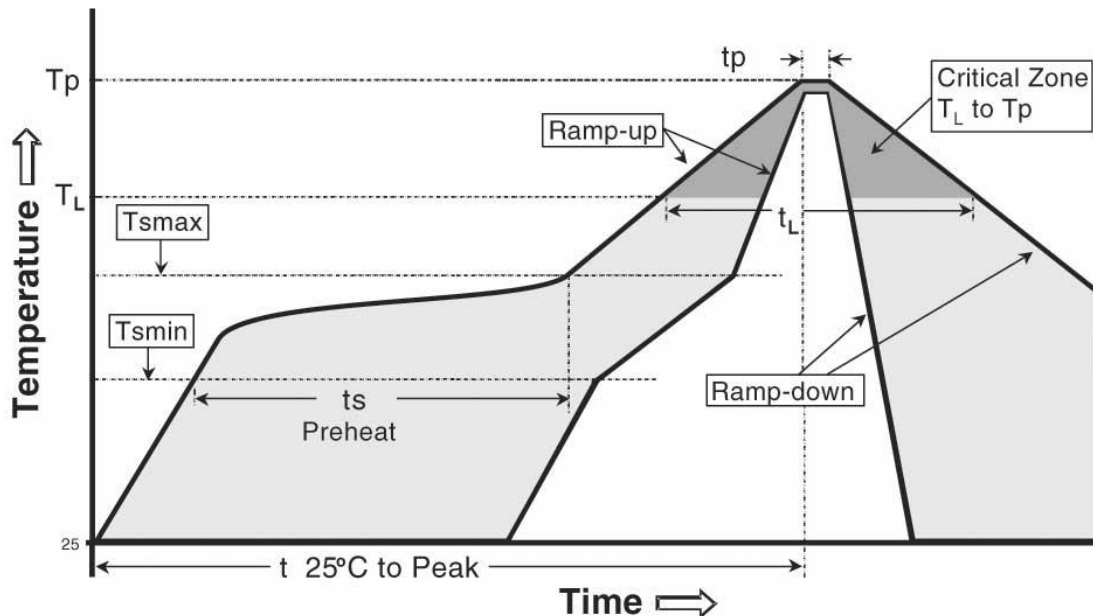
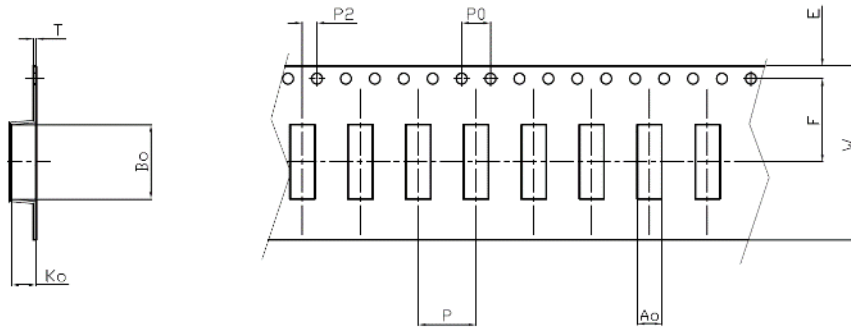

Figure 20 – Temperature profile.

PACKAGING

The RUN mXTEND™ antenna booster NN02-224 is delivered in tape and reel packaging.



Measure	mm
Ao	3.3 ± 0.1
Bo	12.3 ± 0.1
Ko	2.8 ± 0.1
W	24.0 ± 0.3
P	8.0 ± 0.1
P0	4.0 ± 0.1
P2	2.0 ± 0.1
E	1.75 ± 0.1
F	11.5 ± 0.1
T	0.3 ± 0.05

Figure 21 – Tape dimensions and Tolerances.

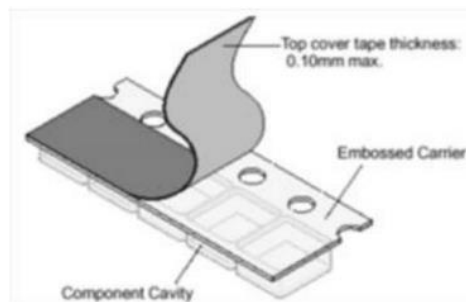
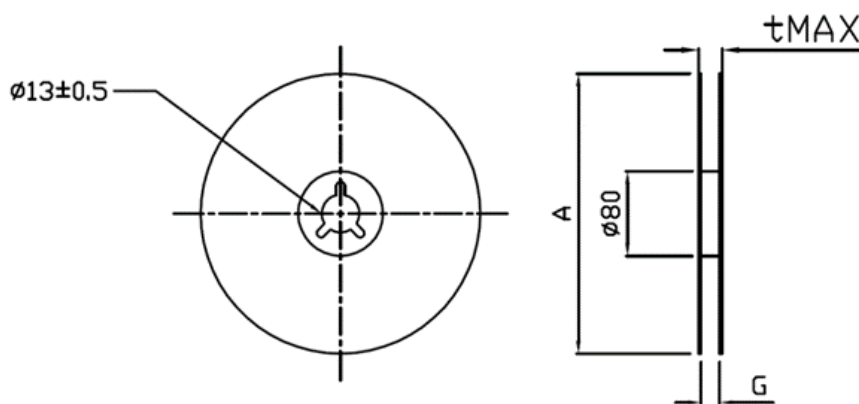

Figure 22 – Image of the tape.



Measure	mm
A	330 ± 1.0
G	25.5 ± 0.2
tMAX	29.5 ± 0.2

Reel Capacity: 2000 pcs

Figure 23 – Reel Dimensions and Capacity.

Ignion products and solutions are protected by [Ignion patents](#).

All information contained within this document is property of Ignion and is subject to change without prior notice. Information is provided “as is” and without warranties. It is prohibited to copy or reproduce this information without prior approval.

Ignion is an ISO 9001:2015 certified company. All our antennas are lead-free and RoHS compliant.

ISO 9001: 2015 Certified



PRODUCT CHANGE NOTIFICATION

This document is property of Ignion,
Not to disclose or copy without prior written consent

PCN Number: NN19100011

Notification Date: October 07th, 2019

Part Number identification:

Part Number changes, it will be applied in all the document of the company (User Manual, Data Sheet, ...)

Previous Part Number
FR01-S4-224

New Part Number
NN02-224

Reason for change:

<input type="checkbox"/> Specs (electrical/mechanical)	<input type="checkbox"/> Manufacturing location
<input type="checkbox"/> User Manual/Data Sheet	<input type="checkbox"/> Quality/Reliability
<input type="checkbox"/> Material/Composition	<input type="checkbox"/> Logistics
<input type="checkbox"/> Processing/Manufacturing	<input checked="" type="checkbox"/> Other: Part Number

Change description

1.- Part Number: From FR01-S4-224 FRACTUS to NN02-224 Ignion in the User Manual

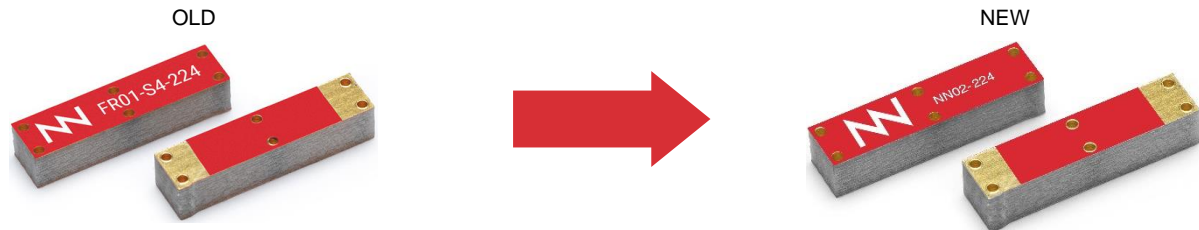

Comments:

- 1.- Electrical and Mechanical specs remain the same
- 2.- Footprint in the PCB to solder the chip antenna remains the same

Identification method

1.- The part number on the antenna is different

User Manual	<input checked="" type="checkbox"/>	Available from: June 2020
Samples	<input checked="" type="checkbox"/>	Available from: June 2020

Ignion Contact:

Sales
Name: Josep Portabella
josep.portabella@ignion.io

Supply Chain
Albert Vidal
albert.vidal@ignion.io