

ignion<sup>™</sup>

Your innovation.  
Accelerated.

# **RUN mXTEND<sup>™</sup>: ISM868/915 (863-870 MHz) and (902-928 MHz)**

APPLICATION NOTE  
RUN mXTEND<sup>™</sup> (NN02-224)

## RUN mXTEND<sup>™</sup> (NN02-224) – ISM868/915 863-870 MHz and 902-928 MHz

Ignion specializes in enabling effective mobile communications. Using Ignion technology, we design and manufacture optimized antennas to make your wireless devices more competitive. Our mission is to help our clients develop innovative products and accelerate their time to market through our expertise in antenna design, testing and manufacturing.



RUN mXTEND<sup>™</sup> antenna booster

NN02-224

Ignion products are protected by [Ignion patents](#).

All information contained within this document is property of Ignion and is subject to change without prior notice. Information is provided “as is” and without warranties. It is prohibited to copy or reproduce this information without prior approval.

Ignion is an ISO 9001:2015 certified company. All our antennas are lead-free and RoHS compliant.

ISO 9001: 2015



## TABLE OF CONTENTS

<b>1. PRODUCT DESCRIPTION NN02-224</b>	<b>5</b>
<b>2. EVALUATION BOARD 863-870 MHz</b>	<b>6</b>
<b>2.1. QUICK REFERENCE GUIDE</b>	<b>6</b>
<b>2.2. EVALUATION BOARD</b>	<b>6</b>
<b>2.3. MATCHING NETWORK</b>	<b>7</b>
<b>2.4. VSWR AND TOTAL EFFICIENCY</b>	<b>8</b>
<b>2.5. RADIATION PATTERNS (863-870 MHz), GAIN AND EFFICIENCY</b>	<b>9</b>
<b>3. EVALUATION BOARD 902-928 MHz</b>	<b>10</b>
<b>3.1. QUICK REFERENCE GUIDE</b>	<b>10</b>
<b>3.2. EVALUATION BOARD</b>	<b>10</b>
<b>3.3. MATCHING NETWORK</b>	<b>11</b>
<b>3.4. VSWR AND TOTAL EFFICIENCY</b>	<b>12</b>
<b>3.5. RADIATION PATTERNS (902-928 MHz), GAIN AND EFFICIENCY</b>	<b>13</b>
<b>4. EVALUATION BOARD 863-928 MHz</b>	<b>14</b>
<b>4.1. QUICK REFERENCE GUIDE</b>	<b>14</b>
<b>4.2. EVALUATION BOARD</b>	<b>14</b>
<b>4.3. MATCHING NETWORK</b>	<b>15</b>
<b>4.4. VSWR AND TOTAL EFFICIENCY</b>	<b>16</b>
<b>4.5. RADIATION PATTERNS (863-928 MHz), GAIN AND EFFICIENCY</b>	<b>17</b>
<b>5. EVALUATION BOARD CR80 863-870 MHz</b>	<b>18</b>
<b>5.1. QUICK REFERENCE GUIDE</b>	<b>18</b>
<b>5.2. EVALUATION BOARD</b>	<b>18</b>
<b>5.3. MATCHING NETWORK</b>	<b>19</b>
<b>5.4. VSWR AND TOTAL EFFICIENCY</b>	<b>20</b>
<b>5.5. RADIATION PATTERNS (863-870 MHz), GAIN AND EFFICIENCY</b>	<b>21</b>
<b>6. EVALUATION BOARD CR80 902-928 MHz</b>	<b>22</b>
<b>6.1. QUICK REFERENCE GUIDE</b>	<b>22</b>

<b>6.2.</b>	<b>EVALUATION BOARD</b>	<b>22</b>
<b>6.3.</b>	<b>MATCHING NETWORK</b>	<b>23</b>
<b>6.4.</b>	<b>VSWR AND TOTAL EFFICIENCY</b>	<b>24</b>
<b>6.5.</b>	<b>RADIATION PATTERNS (902-928 MHz), GAIN AND EFFICIENCY</b>	<b>25</b>
<b>7.</b>	<b>EVALUATION BOARD CR80 863-928 MHz</b>	<b>26</b>
<b>7.1.</b>	<b>QUICK REFERENCE GUIDE</b>	<b>26</b>
<b>7.2.</b>	<b>EVALUATION BOARD</b>	<b>26</b>
<b>7.3.</b>	<b>MATCHING NETWORK</b>	<b>27</b>
<b>7.4.</b>	<b>VSWR AND TOTAL EFFICIENCY</b>	<b>28</b>
<b>7.5.</b>	<b>RADIATION PATTERNS (863-928 MHz), GAIN AND EFFICIENCY</b>	<b>29</b>

## 1. PRODUCT DESCRIPTION NN02-224

The RUN mXTEND<sup>™</sup> antenna booster has been specifically designed for providing multiband performance in wireless devices (in particular in mobile devices), enabling worldwide coverage by allowing operation in the communication standards such as ISM868, ISM915, Zigbee, and RFID.

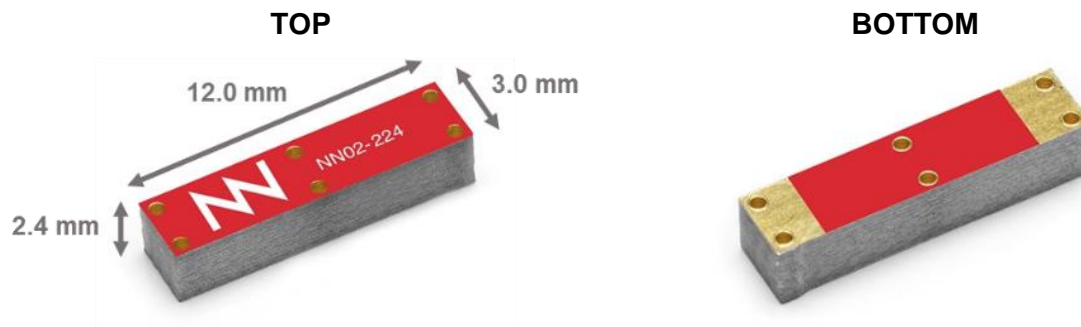

**Material:** The RUN mXTEND<sup>™</sup> antenna booster is built on glass epoxy substrate.

### APPLICATIONS

- Handsets
- Smartphones
- Tablets
- Phablets
- Laptop PCs
- Netbooks
- Modules
- Routers
- eBook readers

### BENEFITS

- High efficiency
- Small size
- Cost-effective
- Easy-to-use (pick and place)
- Multiband behaviour (worldwide standards)
- Off-the-Shelf Standard Product (no customization is required)

The RUN mXTEND<sup>™</sup> antenna booster belongs to a new generation of antenna solutions based on the Virtual Antenna<sup>™</sup> technology developed by Ignion. The technology is mainly focused on replacing conventional antenna solutions by miniature and standard components.

This project has received funding from the European Union's Horizon 2020 research and innovation programme under grant agreement N° 674491



## 2. EVALUATION BOARD 863-870 MHz

### 2.1. QUICK REFERENCE GUIDE

Technical features	863 – 870 MHz
Average Efficiency	> 85.0 %
Peak Gain	2.1 dBi
VSWR	< 2:1
Radiation Pattern	Omnidirectional
Polarization	Linear
Weight (approx.)	0.19 g
Temperature	-40 to +125 °C
Impedance	50 Ω
Dimensions (L x W x H)	12.0 mm x 3.0 mm x 2.4 mm

Table 1 – Technical Features. Measures from the evaluation board. See Figure 1.

### 2.2. EVALUATION BOARD

This Evaluation Board EB\_NN02-224-868 integrates a UFL cable to connect the RUN mXTEND™ antenna booster with the SMA connector. The RUN mXTEND™ provides operation in the frequency region which covers from 863 MHz to 870 MHz, through a single input/output port.

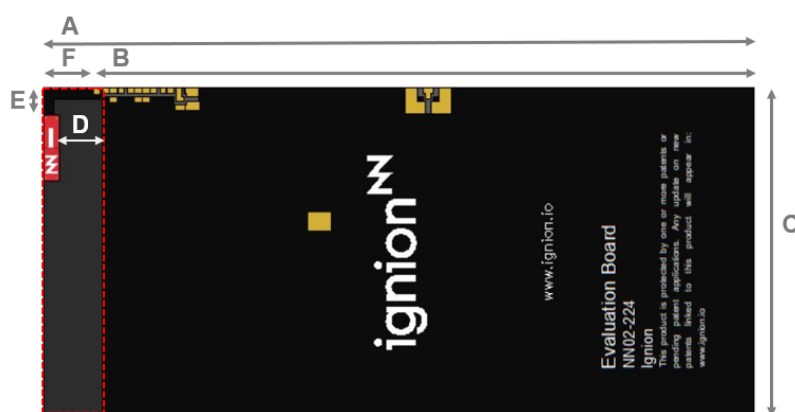

Measure	mm
A	131
B	120
C	60
D	8.0
E	5.0
F	11

**Tolerance:** ±0.2 mm

**D:** Distance between the RUN mXTEND™ antenna booster and the ground plane.

**Material:** The evaluation board is built on FR4 substrate. Thickness is 1 mm.

**Clearance Area:** 11 mm x 60 mm (F x C)

Figure 1 – EB\_NN02-224-868. Evaluation Board providing operation from 863 MHz to 870 MHz.

This product and its use is protected by at least one or more of the following [patents and patent applications](#) US 8,203,492; US 8,237,615; PCT/EP2013/064692; WO2014/012842; US 62/028,494; US 62/072,671; and other domestic and international patents pending. Additional information about patents related to this product is available at [www.ignion.io/virtual-antenna/](http://www.ignion.io/virtual-antenna/).

## 2.3. MATCHING NETWORK

The specs of a Ignion standard product are measured in their evaluation board, which is an ideal case. In a real design, components nearby the antenna, LCD's, batteries, covers, connectors, etc. affect the antenna performance. This is the reason why it is highly recommended placing pads compatible with 0402 and 0603 SMD components for a matching network as close as possible to the feeding point. Do it in the ground plane area, not in the clearance area. This provides a degree of freedom to tune the RUN mXTEND™ antenna booster once the design is finished and taking into account all elements of the system (batteries, displays, covers, etc.).

Please note that different devices with different ground planes and different components nearby the RUN mXTEND™ antenna booster may need a different matching network. To ensure optimal results, the use of high Q and tight tolerance components is highly recommended (Murata components). Please, if you need assistance contact [support@ignion.io](mailto:support@ignion.io) for more information related to the antenna booster matching service.

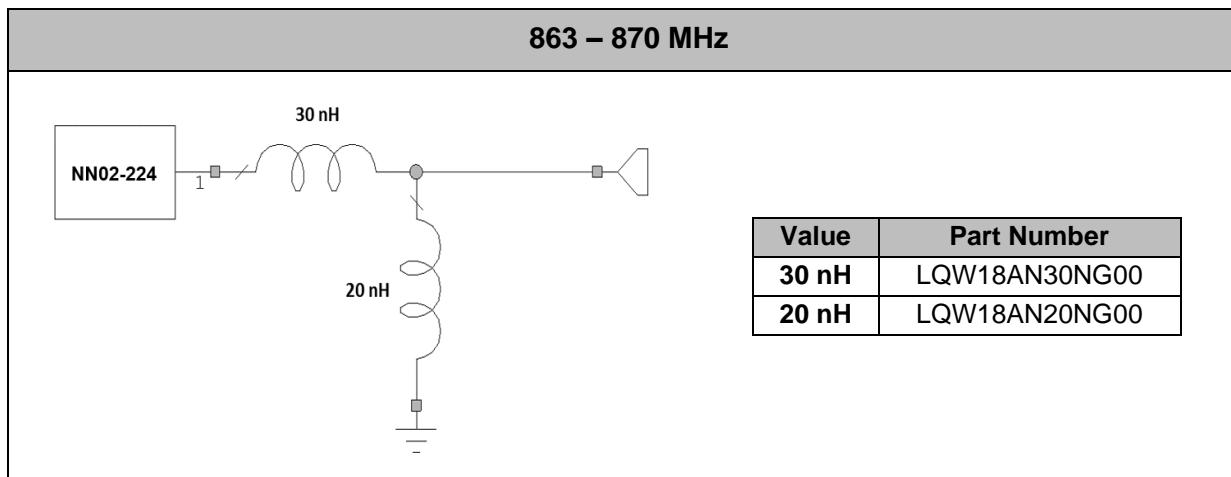

**Figure 2 – Matching Network implemented in the evaluation board (Figure 1)**

For additional information, please visit [www.ignion.io](http://www.ignion.io) or contact [info@ignion.io](mailto:info@ignion.io).

If you need assistance to design your matching network, please contact [support@ignion.io](mailto:support@ignion.io), or try our free-of-charge<sup>1</sup> **NN Wireless Fast-Track** design service, you will get your chip antenna design including a custom matching network for your device in 24h<sup>1</sup>. Other related to NN's range of R&D services is available at: <https://www.ignion.io/rdservices/>

<sup>1</sup> See terms and conditions for a free NN Wireless Fast-Track service in 24h at: <https://www.ignion.io/fast-track-project/>

## 2.4. VSWR AND TOTAL EFFICIENCY

VSWR (Voltage Standing Wave Ratio) and Total Efficiency versus Frequency (GHz).

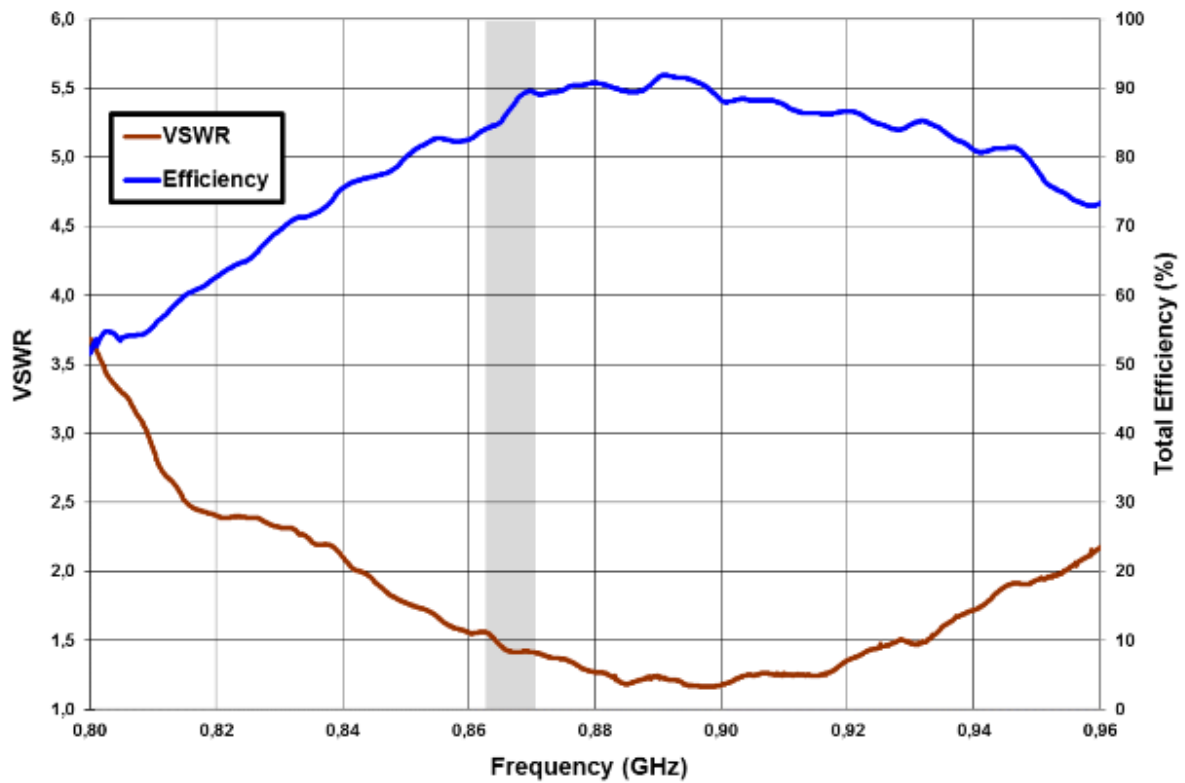

**Figure 3** – VSWR and Total Efficiency for the 863 – 870 MHz from the evaluation board (Figure 1).



## 2.5. RADIATION PATTERNS (863-870 MHz), GAIN AND EFFICIENCY

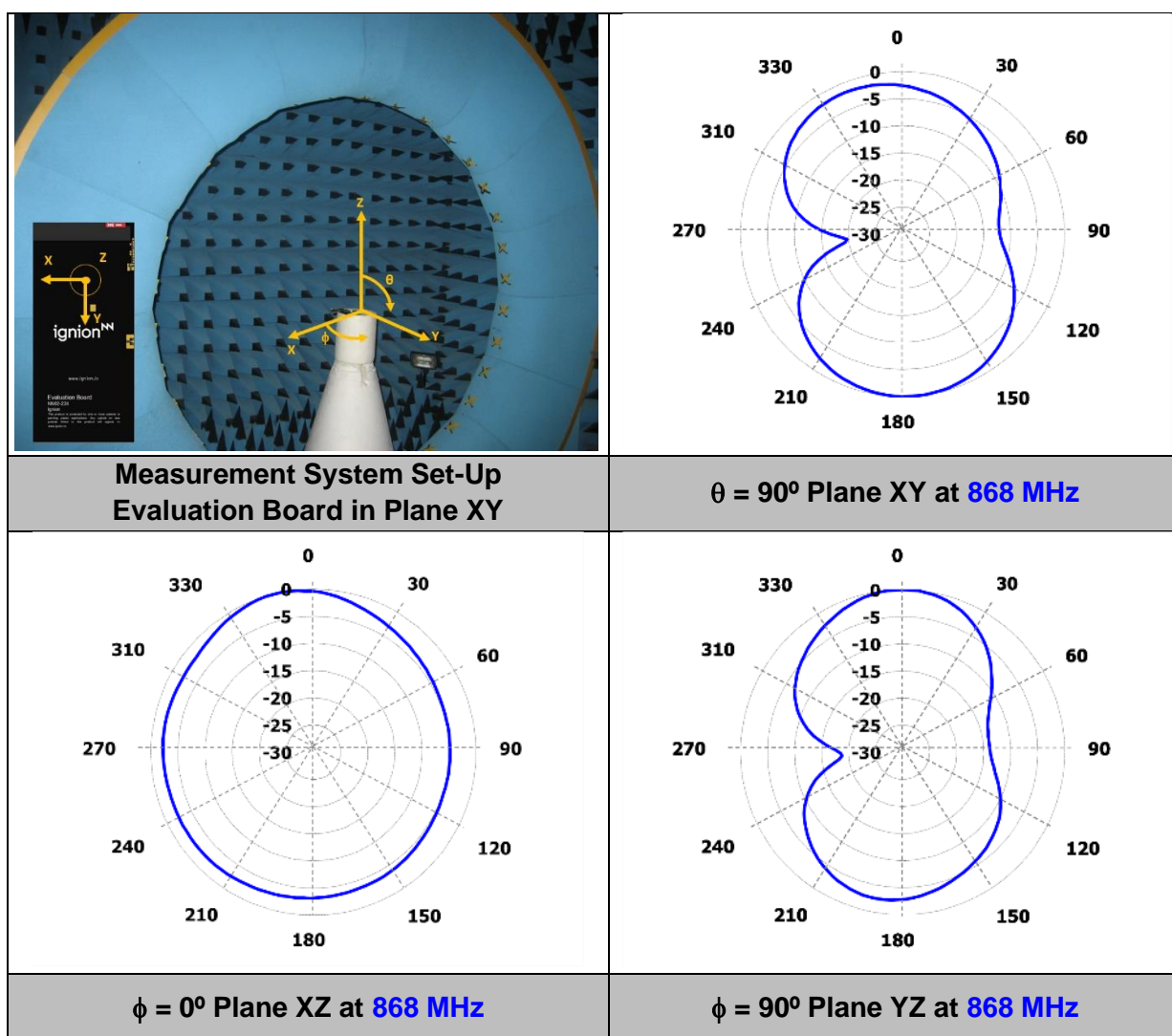

<b>Gain</b>	<b>Peak Gain</b>	2.1 dBi
	<b>Average Gain across the band</b>	1.9 dBi
	<b>Gain Range across the band (min, max)</b>	1.7 <--> 2.1 dBi
<b>Efficiency</b>	<b>Peak Efficiency</b>	91.5 %
	<b>Average Efficiency across the band</b>	88.6 %
	<b>Efficiency Range across the band (min, max)</b>	84.2 – 91.5 %

**Table 2** – Antenna Gain and Total Efficiency from the evaluation board (Figure 1) within the 863 – 870 MHz frequency range. Measures made in the Satimo STARGATE 32 anechoic chamber.

### 3. EVALUATION BOARD 902-928 MHz

#### 3.1. QUICK REFERENCE GUIDE

Technical features	902 – 928 MHz
Average Efficiency	> 85.0 %
Peak Gain	2.1 dBi
VSWR	< 2:1
Radiation Pattern	Omnidirectional
Polarization	Linear
Weight (approx.)	0.19 g
Temperature	-40 to +125 °C
Impedance	50 Ω
Dimensions (L x W x H)	12.0 mm x 3.0 mm x 2.4 mm

Table 3 – Technical Features. Measures from the evaluation board. See Figure 4.

#### 3.2. EVALUATION BOARD

This Evaluation Board EB\_NN02-224-915 integrates a UFL cable to connect the RUN mXTEND™ antenna booster with the SMA connector. The RUN mXTEND™ provides operation in the frequency region which covers from 902 MHz to 928 MHz, through a single input/output port.



Measure	mm
A	131
B	120
C	60
D	8.0
E	5.0
F	11

**Tolerance:** ±0.2 mm

**D:** Distance between the RUN mXTEND™ antenna booster and the ground plane.

**Material:** The evaluation board is built on FR4 substrate. Thickness is 1 mm.

**Clearance Area:** 11 mm x 60 mm (F x C)

Figure 4 – EB\_NN02-224-915. Evaluation Board providing operation from 902 MHz to 928 MHz.

This product and its use is protected by at least one or more of the following [patents and patent applications](#) US 8,203,492; US 8,237,615; PCT/EP2013/064692; WO2014/012842; US 62/028,494; US 62/072,671; and other domestic and international patents pending. Additional information about patents related to this product is available at [www.ignion.io/virtual-antenna/](http://www.ignion.io/virtual-antenna/).

### 3.3. MATCHING NETWORK

The specs of a Ignion standard product are measured in their evaluation board, which is an ideal case. In a real design, components nearby the antenna, LCD's, batteries, covers, connectors, etc. affect the antenna performance. This is the reason why it is highly recommended placing pads compatible with 0402 and 0603 SMD components for a matching network as close as possible to the feeding point. Do it in the ground plane area, not in the clearance area. This provides a degree of freedom to tune the RUN mXTEND™ antenna booster once the design is finished and taking into account all elements of the system (batteries, displays, covers, etc.).

Please note that different devices with different ground planes and different components nearby the RUN mXTEND™ antenna booster may need a different matching network. To ensure optimal results, the use of high Q and tight tolerance components is highly recommended (Murata components). Please, if you need assistance contact [support@ignion.io](mailto:support@ignion.io) for more information related to the antenna booster matching service.

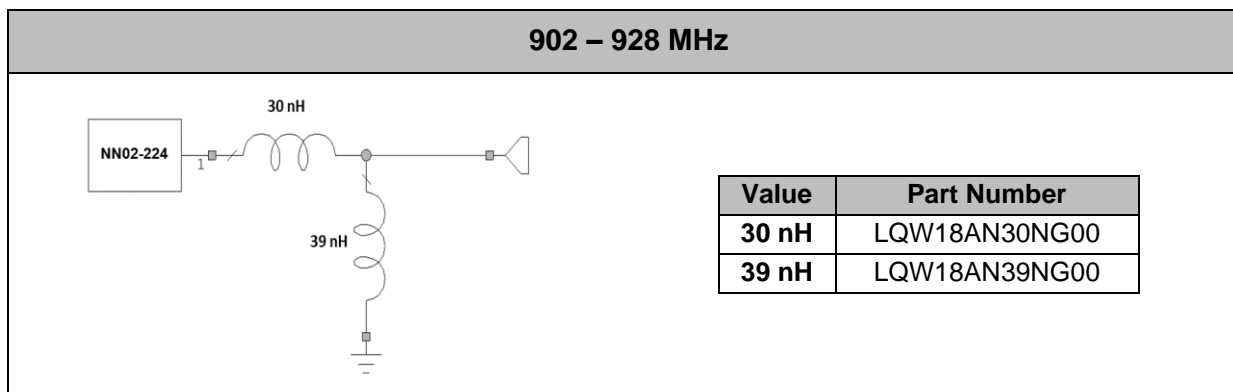

**Figure 5 – Matching Network implemented in the evaluation board (Figure 4)**

For additional information, please visit [www.ignion.io](http://www.ignion.io) or contact [info@ignion.io](mailto:info@ignion.io).

If you need assistance to design your matching network, please contact [support@ignion.io](mailto:support@ignion.io), or try our free-of-charge<sup>1</sup> **NN Wireless Fast-Track** design service, you will get your chip antenna design including a custom matching network for your device in 24h<sup>2</sup>. Other related to NN's range of R&D services is available at: <https://www.ignion.io/rdservices/>

<sup>2</sup> See terms and conditions for a free NN Wireless Fast-Track service in 24h at: <https://www.ignion.io/fast-track-project/>

### 3.4. VSWR AND TOTAL EFFICIENCY

VSWR (Voltage Standing Wave Ratio) and Total Efficiency versus Frequency (GHz).

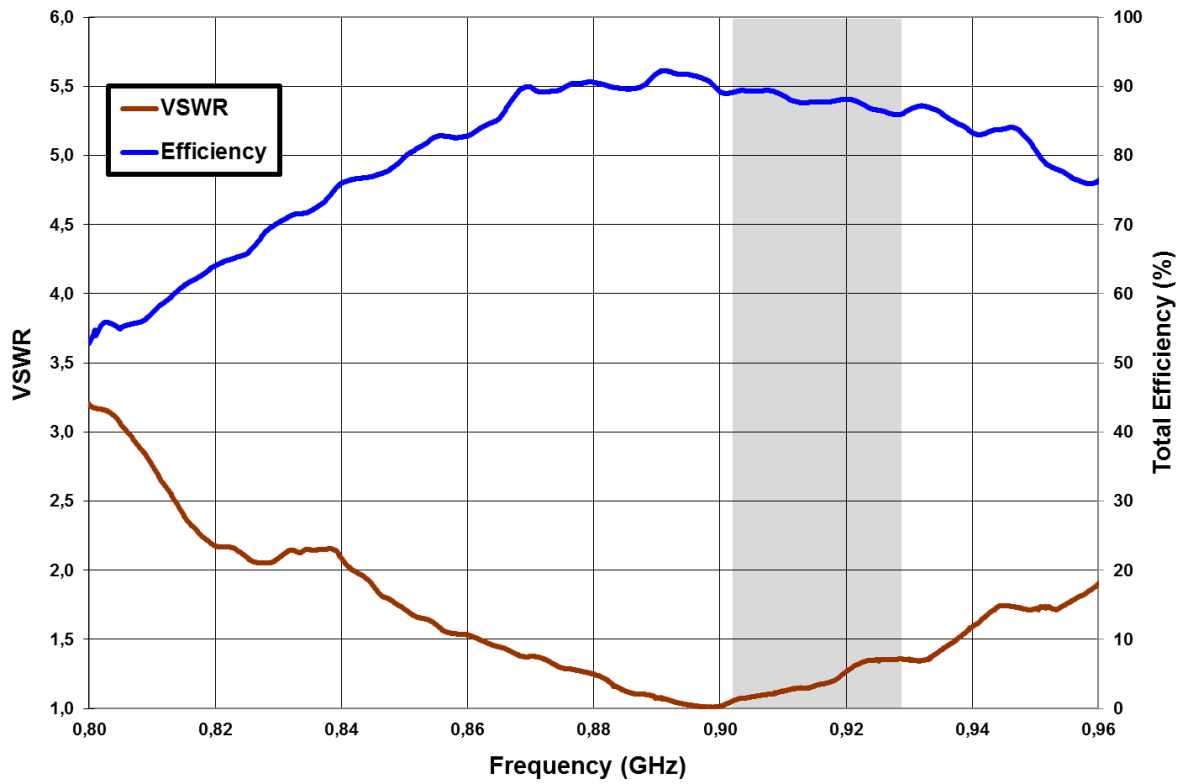

**Figure 6** – VSWR and Total Efficiency for the 902 – 928 MHz from the evaluation board (Figure 4).

### 3.5. RADIATION PATTERNS (902-928 MHz), GAIN AND EFFICIENCY

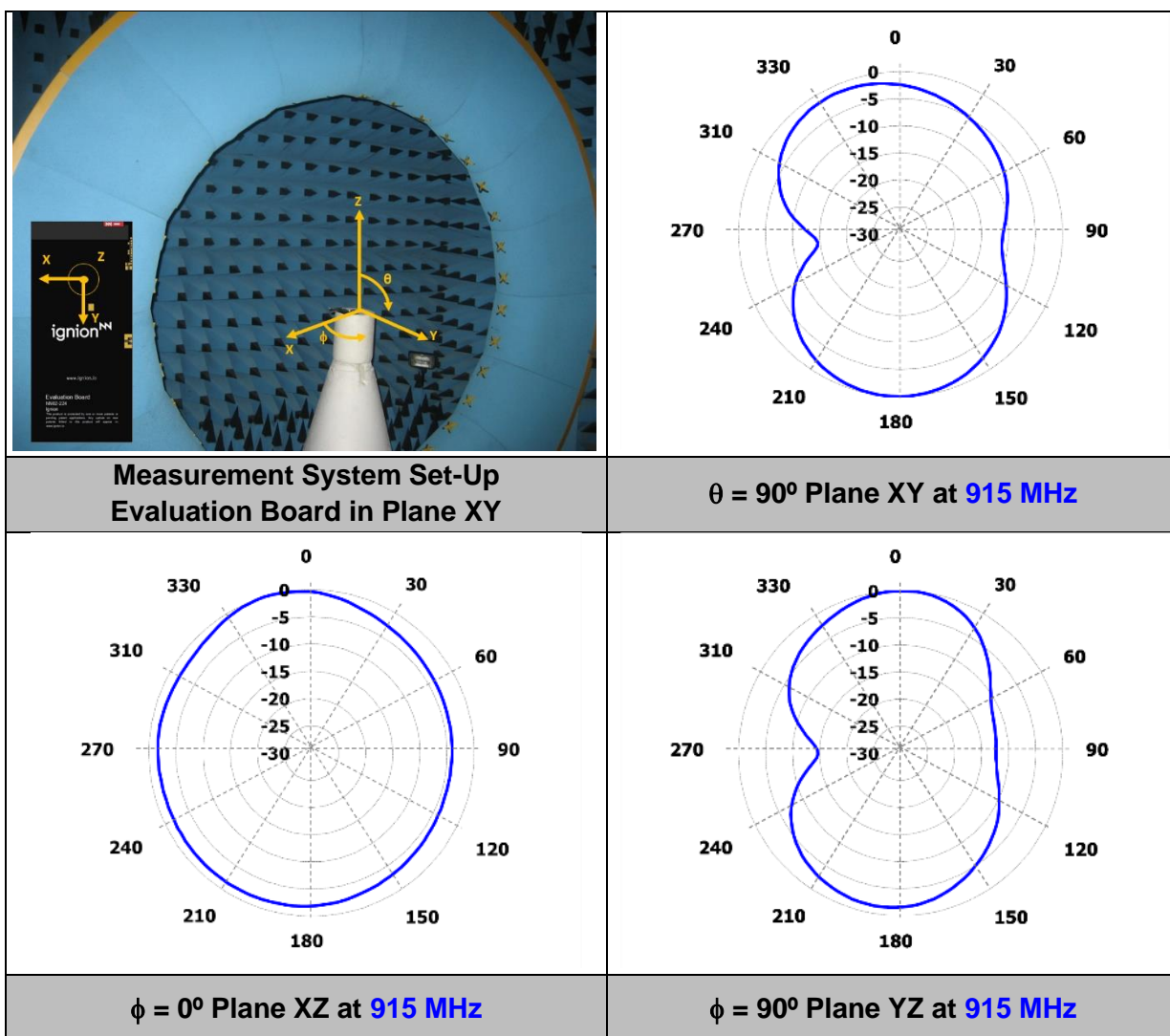

<b>Gain</b>	<b>Peak Gain</b>	2.1 dBi
	<b>Average Gain across the band</b>	2.0 dBi
	<b>Gain Range across the band (min, max)</b>	1.9 <--> 2.1 dBi
<b>Efficiency</b>	<b>Peak Efficiency</b>	90.2 %
	<b>Average Efficiency across the band</b>	87.7 %
	<b>Efficiency Range across the band (min, max)</b>	84.8 – 90.2 %

**Table 4** – Antenna Gain and Total Efficiency from the evaluation board (Figure 4) within the 902 – 928 MHz frequency range. Measures made in the Satimo STARGATE 32 anechoic chamber.

## 4. EVALUATION BOARD 863-928 MHz

### 4.1. QUICK REFERENCE GUIDE

Technical features	863 – 928 MHz
Average Efficiency	> 80.0 %
Peak Gain	2.2 dBi
VSWR	< 2:1
Radiation Pattern	Omnidirectional
Polarization	Linear
Weight (approx.)	0.19 g
Temperature	-40 to +125 °C
Impedance	50 Ω
Dimensions (L x W x H)	12.0 mm x 3.0 mm x 2.4 mm

Table 5 – Technical Features. Measures from the evaluation board. See Figure 7.

### 4.2. EVALUATION BOARD

This Evaluation Board EB\_NN02-224-868-915 integrates a UFL cable to connect the RUN mXTEND™ antenna booster with the SMA connector. The RUN mXTEND™ provides operation in the frequency region which covers from 863 MHz to 928 MHz, through a single input/output port.

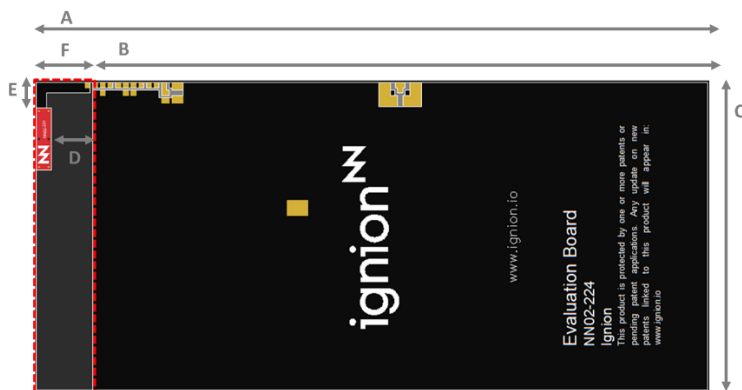

Measure	mm
A	131
B	120
C	60
D	8.0
E	5.0
F	11

Tolerance: ±0.2 mm

D: Distance between the RUN mXTEND™ antenna booster and the ground plane.

**Material:** The evaluation board is built on FR4 substrate. Thickness is 1 mm.

**Clearance Area:** 11 mm x 60 mm (F x C)

Figure 7 – EB\_NN02-224-868-915. Evaluation Board providing operation from 863 MHz to 928 MHz.

This product and its use is protected by at least one or more of the following [patents and patent applications](#) US 8,203,492; US 8,237,615; PCT/EP2013/064692; WO2014/012842; US 62/028,494; US 62/072,671; and other domestic and international patents pending. Additional information about patents related to this product is available at [www.ignion.io/virtual-antenna/](http://www.ignion.io/virtual-antenna/).

### 4.3. MATCHING NETWORK

The specs of a Ignion standard product are measured in their evaluation board, which is an ideal case. In a real design, components nearby the antenna, LCD's, batteries, covers, connectors, etc. affect the antenna performance. This is the reason why it is highly recommended placing pads compatible with 0402 and 0603 SMD components for a matching network as close as possible to the feeding point. Do it in the ground plane area, not in the clearance area. This provides a degree of freedom to tune the RUN mXTEND™ antenna booster once the design is finished and taking into account all elements of the system (batteries, displays, covers, etc.).

Please note that different devices with different ground planes and different components nearby the RUN mXTEND™ antenna booster may need a different matching network. To ensure optimal results, the use of high Q and tight tolerance components is highly recommended (Murata components). Please, if you need assistance contact [support@ignion.io](mailto:support@ignion.io) for more information related to the antenna booster matching service.

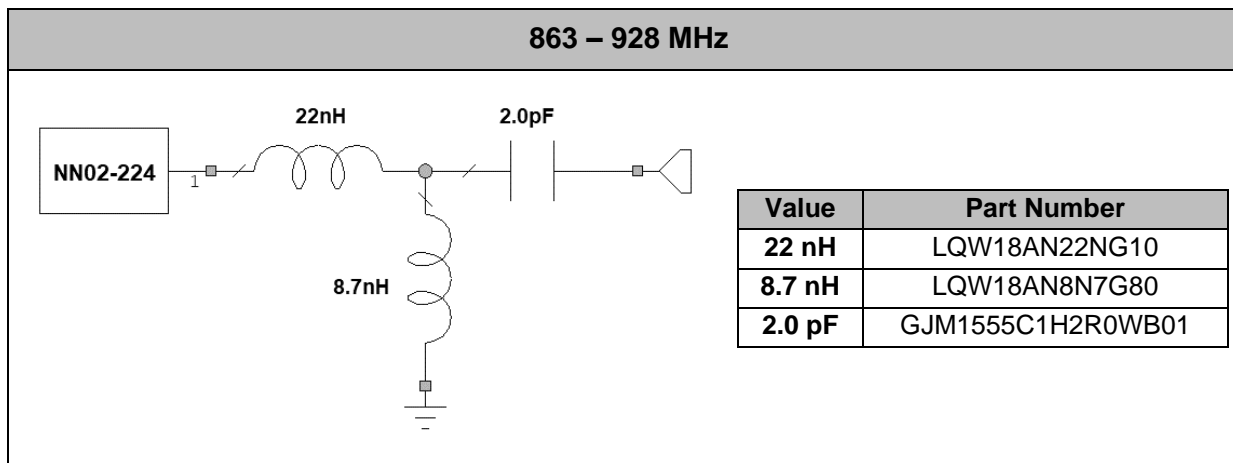

**Figure 8** – Matching Network implemented in the evaluation board (Figure 7)

For additional information, please visit [www.ignion.io](http://www.ignion.io) or contact [info@ignion.io](mailto:info@ignion.io).

If you need assistance to design your matching network, please contact [support@ignion.io](mailto:support@ignion.io), or try our free-of-charge<sup>1</sup> **NN Wireless Fast-Track** design service, you will get your chip antenna design including a custom matching network for your device in 24h<sup>3</sup>. Other related to NN's range of R&D services is available at: <https://www.ignion.io/rdservices/>

<sup>3</sup> See terms and conditions for a free NN Wireless Fast-Track service in 24h at: <https://www.ignion.io/fast-track-project/>

## 4.4. VSWR AND TOTAL EFFICIENCY

VSWR (Voltage Standing Wave Ratio) and Total Efficiency versus Frequency (GHz).

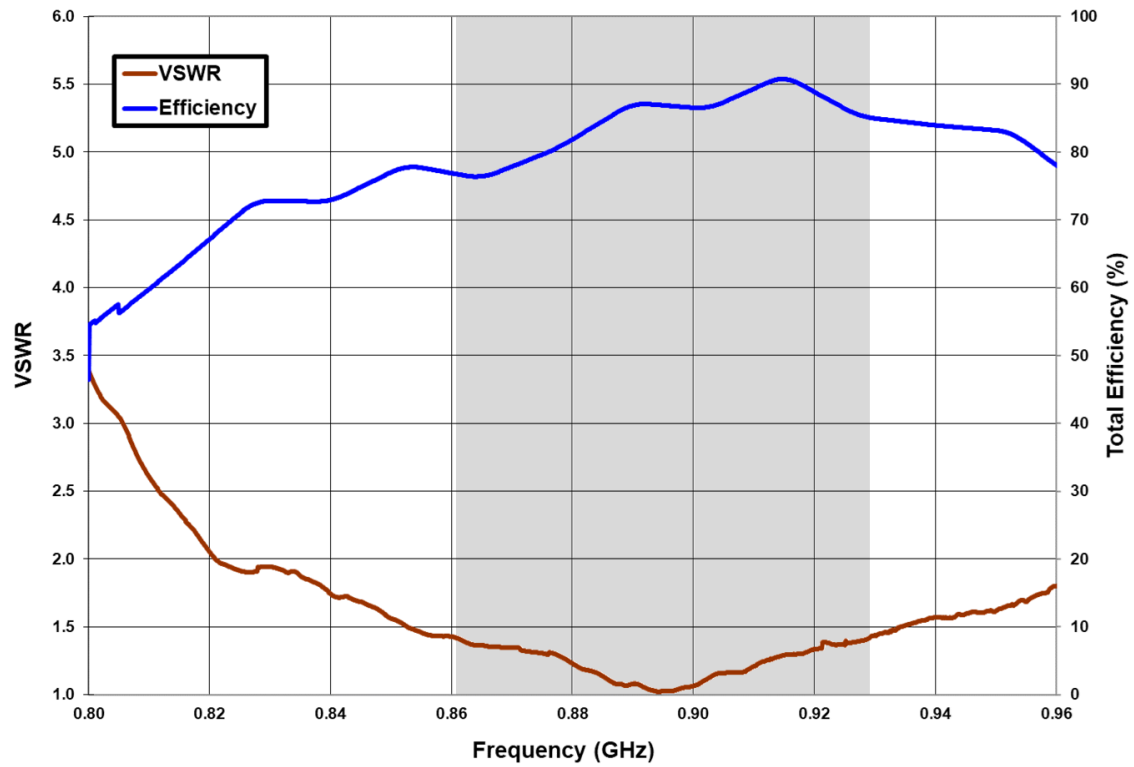

**Figure 9** – VSWR and Total Efficiency for the 863 – 928 MHz from the evaluation board (Figure 7).



### 4.5. RADIATION PATTERNS (863-928 MHz), GAIN AND EFFICIENCY

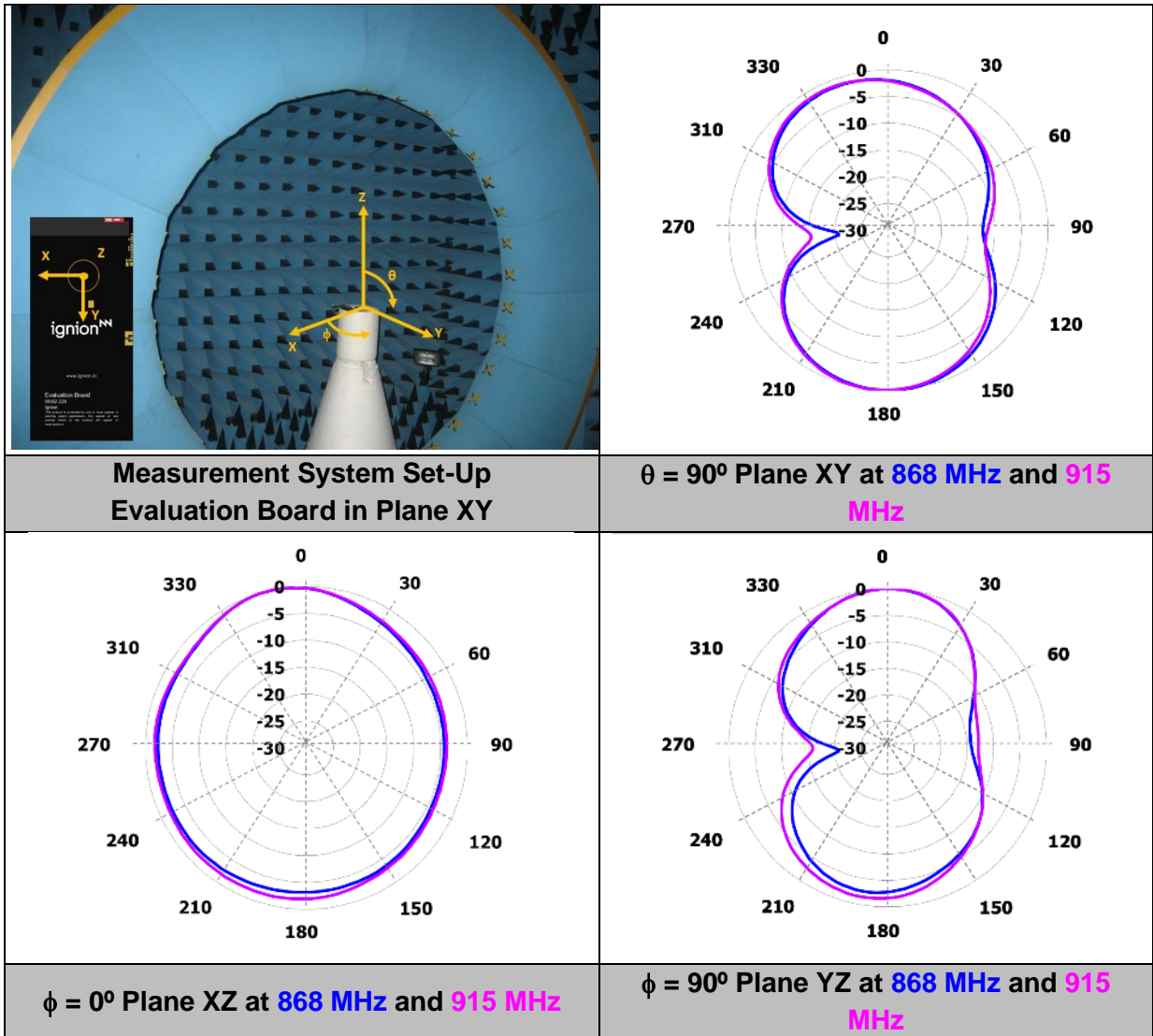

Gain	Peak Gain	2.2 dBi
	Average Gain across the band	1.9 dBi
	Gain Range across the band (min, max)	1.6 <-> 2.2 dBi
Efficiency	Peak Efficiency	87.1 %
	Average Efficiency across the band	85.3 %
	Efficiency Range across the band (min, max)	76.7 – 87.1 %

**Table 6** – Antenna Gain and Total Efficiency from the evaluation board (Figure 7) within the 863 – 928 MHz frequency range. Measures made in the Satimo STARGATE 32 anechoic chamber.

## 5. EVALUATION BOARD CR80 863-870 MHz

### 5.1. QUICK REFERENCE GUIDE

Technical features	863 – 870 MHz
Average Efficiency	> 60.0 %
Peak Gain	0.2 dBi
VSWR	< 2:1
Radiation Pattern	Omnidirectional
Polarization	Linear
Weight (approx.)	0.19 g
Temperature	-40 to +125 °C
Impedance	50 Ω
Dimensions (L x W x H)	12.0 mm x 3.0 mm x 2.4 mm

Table 7 – Technical Features. Measures from the evaluation board. See Figure 10.

### 5.2. EVALUATION BOARD

This Evaluation Board EB\_NN02-224-CR80-868 integrates a UFL cable to connect the RUN mXTEND™ antenna booster with the SMA connector. The RUN mXTEND™ provides operation in the frequency region which covers from 863 MHz to 870 MHz, through a single input/output port.

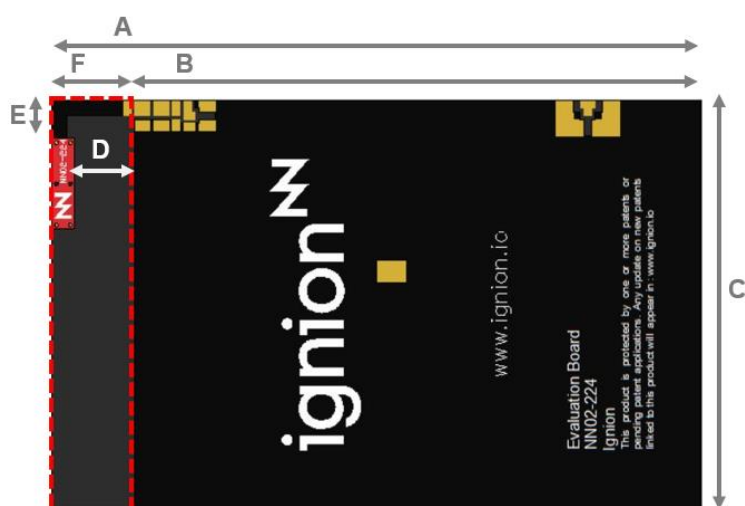

Measure	mm
A	86
B	75
C	54
D	8.0
E	5.0
F	11

Tolerance: ±0.2 mm

**D:** Distance between the RUN mXTEND™ antenna booster and the ground plane.

**Material:** The evaluation board is built on FR4 substrate. Thickness is 1 mm.

**Clearance Area:** 11 mm x 54 mm (F x C)

Figure 10 – EB\_NN02-224-CR80-868. Evaluation Board providing operation from 863 MHz to 870 MHz.

This product and its use is protected by at least one or more of the following [patents and patent applications](#) US 8,203,492; US 8,237,615; PCT/EP2013/064692; WO2014/012842; US 62/028,494; US 62/072,671; and other domestic and international patents pending. Additional information about patents related to this product is available at [www.ignion.io/virtual-antenna/](http://www.ignion.io/virtual-antenna/).

### 5.3. MATCHING NETWORK

The specs of a Ignion standard product are measured in their evaluation board, which is an ideal case. In a real design, components nearby the antenna, LCD's, batteries, covers, connectors, etc. affect the antenna performance. This is the reason why it is highly recommended placing pads compatible with 0402 and 0603 SMD components for a matching network as close as possible to the feeding point. Do it in the ground plane area, not in the clearance area. This provides a degree of freedom to tune the RUN mXTEND™ antenna booster once the design is finished and taking into account all elements of the system (batteries, displays, covers, etc.).

Please note that different devices with different ground planes and different components nearby the RUN mXTEND™ antenna booster may need a different matching network. To ensure optimal results, the use of high Q and tight tolerance components is highly recommended (Murata components). Please, if you need assistance contact [support@ignion.io](mailto:support@ignion.io) for more information related to the antenna booster matching service.

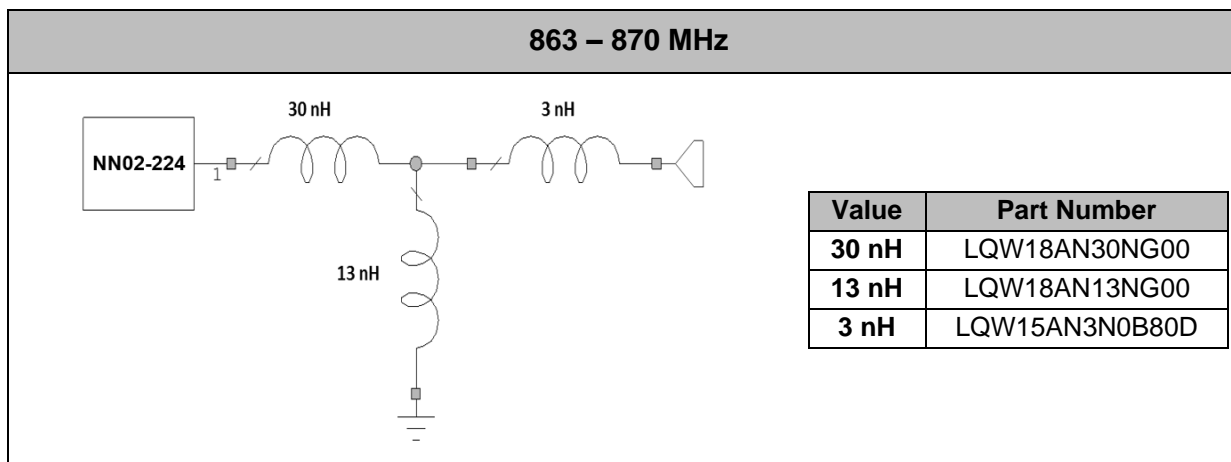

**Figure 11 – Matching Network implemented in the evaluation board (Figure 10)**

For additional information, please visit [www.ignion.io](http://www.ignion.io) or contact [info@ignion.io](mailto:info@ignion.io).

If you need assistance to design your matching network, please contact [support@ignion.io](mailto:support@ignion.io), or try our free-of-charge<sup>1</sup> **NN Wireless Fast-Track** design service, you will get your chip antenna design including a custom matching network for your device in 24h<sup>4</sup>. Other related to NN's range of R&D services is available at: <https://www.ignion.io/rdservices/>

<sup>4</sup> See terms and conditions for a free NN Wireless Fast-Track service in 24h at: <https://www.ignion.io/fast-track-project/>

## 5.4. VSWR AND TOTAL EFFICIENCY

VSWR (Voltage Standing Wave Ratio) and Total Efficiency versus Frequency (GHz).

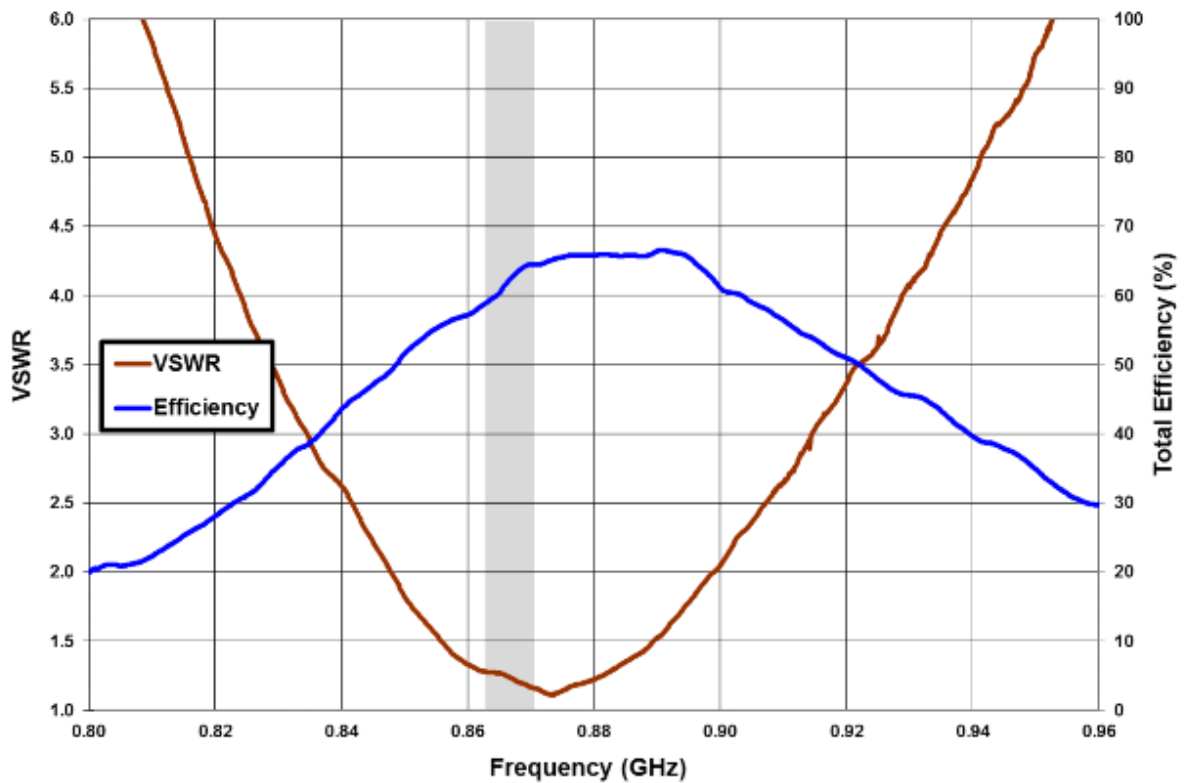

**Figure 12** – VSWR and Total Efficiency for the 863 – 870 MHz from the evaluation board (Figure 10).

## 5.5. RADIATION PATTERNS (863-870 MHz), GAIN AND EFFICIENCY

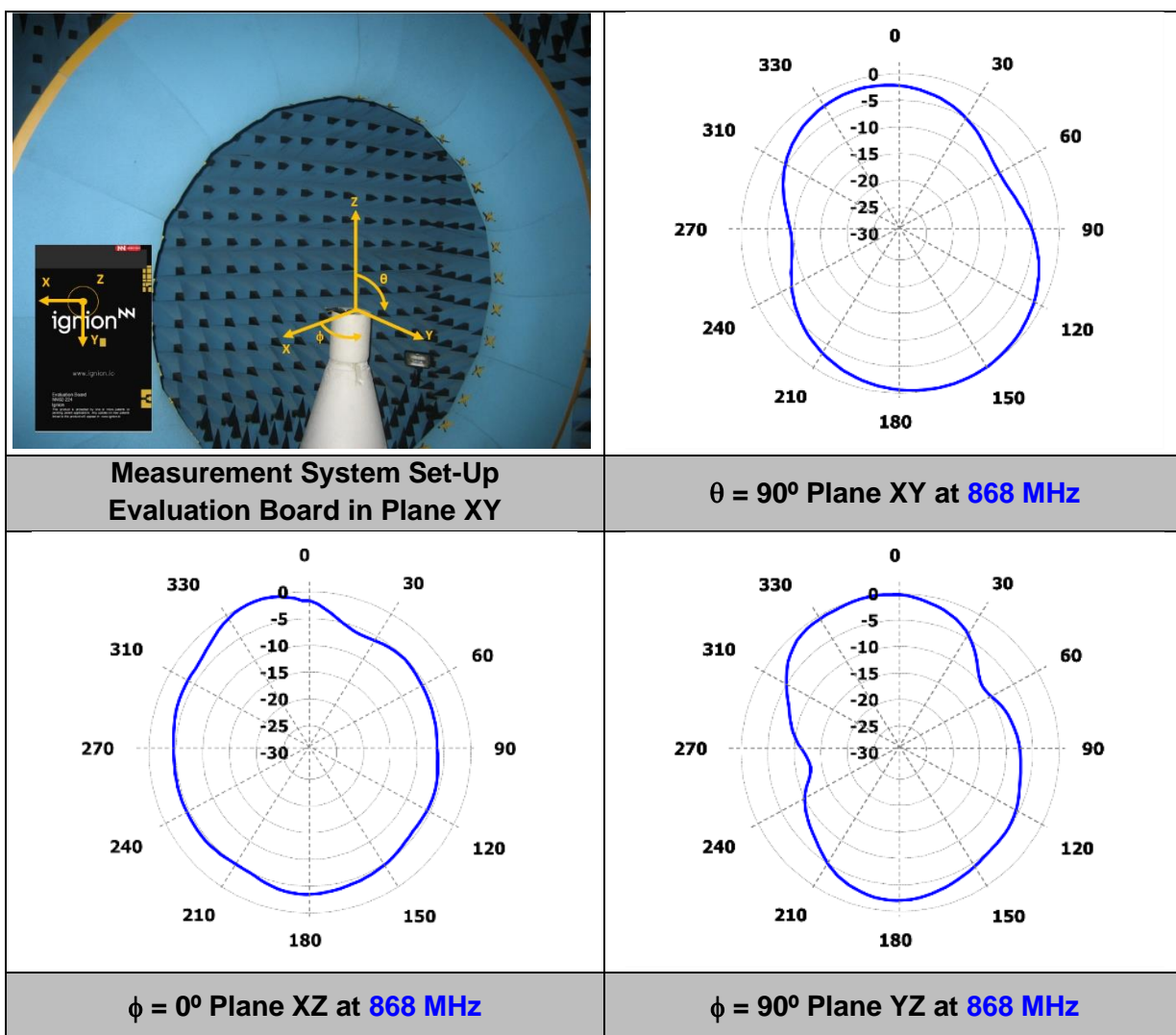

<b>Gain</b>	<b>Peak Gain</b>	0.2 dBi
	<b>Average Gain across the band</b>	0.1 dBi
	<b>Gain Range across the band (min, max)</b>	-0.2 <--> 0.2 dBi
<b>Efficiency</b>	<b>Peak Efficiency</b>	65.7 %
	<b>Average Efficiency across the band</b>	63.7 %
	<b>Efficiency Range across the band (min, max)</b>	60.2 – 65.7 %

**Table 8** – Antenna Gain and Total Efficiency from the evaluation board (Figure 10) within the 863 – 870 MHz frequency range. Measures made in the Satimo STARGATE 32 anechoic chamber.

## 6. EVALUATION BOARD CR80 902-928 MHz

### 6.1. QUICK REFERENCE GUIDE

Technical features	902 – 928 MHz
Average Efficiency	> 60 %
Peak Gain	0.6 dBi
VSWR	< 2:1
Radiation Pattern	Omnidirectional
Polarization	Linear
Weight (approx.)	0.19 g
Temperature	-40 to +125 °C
Impedance	50 Ω
Dimensions (L x W x H)	12.0 mm x 3.0 mm x 2.4 mm

Table 9 – Technical Features. Measures from the evaluation board. See Figure 13.

### 6.2. EVALUATION BOARD

This Evaluation Board EB\_NN02-224-CR80-915 integrates a UFL cable to connect the RUN mXTEND™ antenna booster with the SMA connector. The RUN mXTEND™ provides operation in the frequency region which covers from 902 MHz to 928 MHz, through a single input/output port.

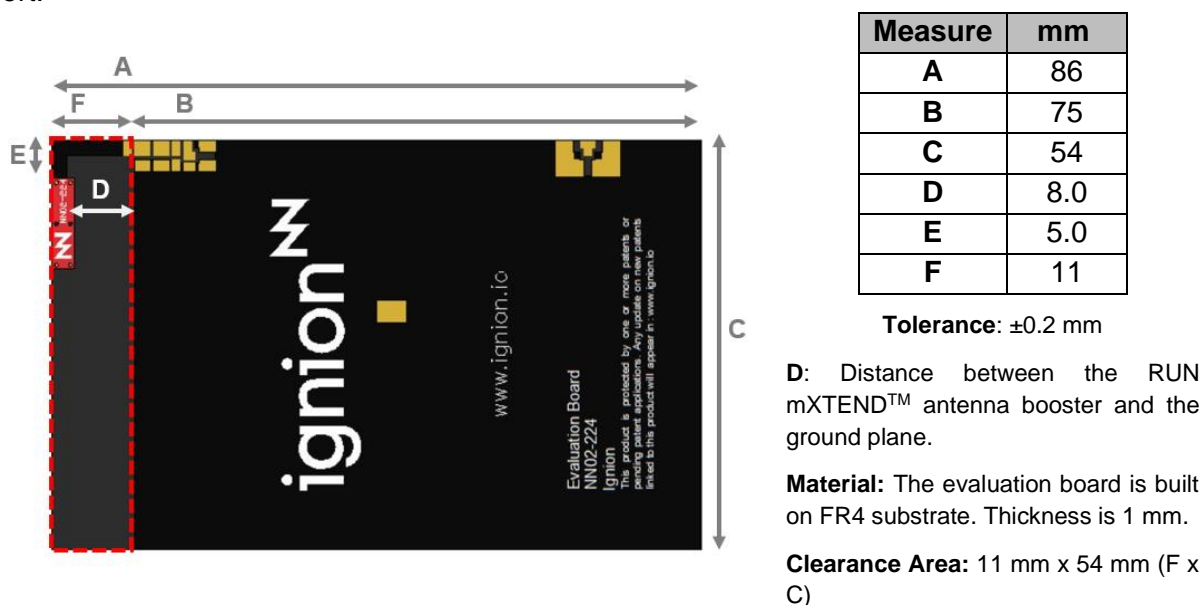

Figure 13 – EB\_NN02-224-915. Evaluation Board providing operation from 902 MHz to 928 MHz.

This product and its use is protected by at least one or more of the following [patents and patent applications](#) US 8,203,492; US 8,237,615; PCT/EP2013/064692; WO2014/012842; US 62/028,494; US 62/072,671; and other domestic and international patents pending. Additional information about patents related to this product is available at [www.ignion.io/virtual-antenna/](http://www.ignion.io/virtual-antenna/).

### 6.3. MATCHING NETWORK

The specs of a Ignion standard product are measured in their evaluation board, which is an ideal case. In a real design, components nearby the antenna, LCD's, batteries, covers, connectors, etc. affect the antenna performance. This is the reason why it is highly recommended placing pads compatible with 0402 and 0603 SMD components for a matching network as close as possible to the feeding point. Do it in the ground plane area, not in the clearance area. This provides a degree of freedom to tune the RUN mXTEND™ antenna booster once the design is finished and taking into account all elements of the system (batteries, displays, covers, etc.).

Please note that different devices with different ground planes and different components nearby the RUN mXTEND™ antenna booster may need a different matching network. To ensure optimal results, the use of high Q and tight tolerance components is highly recommended (Murata components). Please, if you need assistance contact [support@ignion.io](mailto:support@ignion.io) for more information related to the antenna booster matching service.

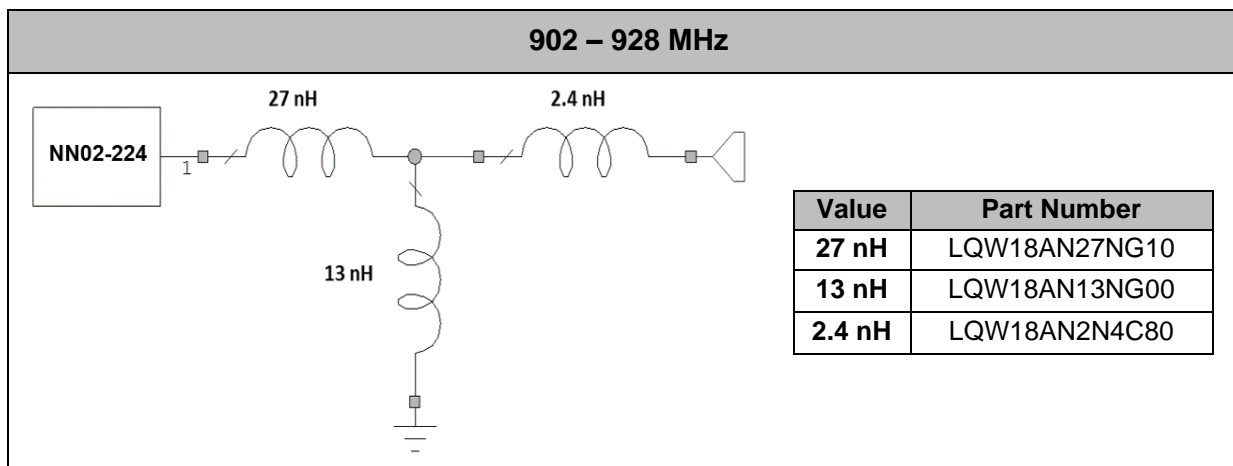

**Figure 14** – Matching Network implemented in the evaluation board (Figure 13)

For additional information, please visit [www.ignion.io](http://www.ignion.io) or contact [info@ignion.io](mailto:info@ignion.io).

If you need assistance to design your matching network, please contact [support@ignion.io](mailto:support@ignion.io), or try our free-of-charge<sup>1</sup> **NN Wireless Fast-Track** design service, you will get your chip antenna design including a custom matching network for your device in 24h<sup>5</sup>. Other related to NN's range of R&D services is available at: <https://www.ignion.io/rdservices/>

<sup>5</sup> See terms and conditions for a free NN Wireless Fast-Track service in 24h at: <https://www.ignion.io/fast-track-project/>

## 6.4. VSWR AND TOTAL EFFICIENCY

VSWR (Voltage Standing Wave Ratio) and Total Efficiency versus Frequency (GHz).

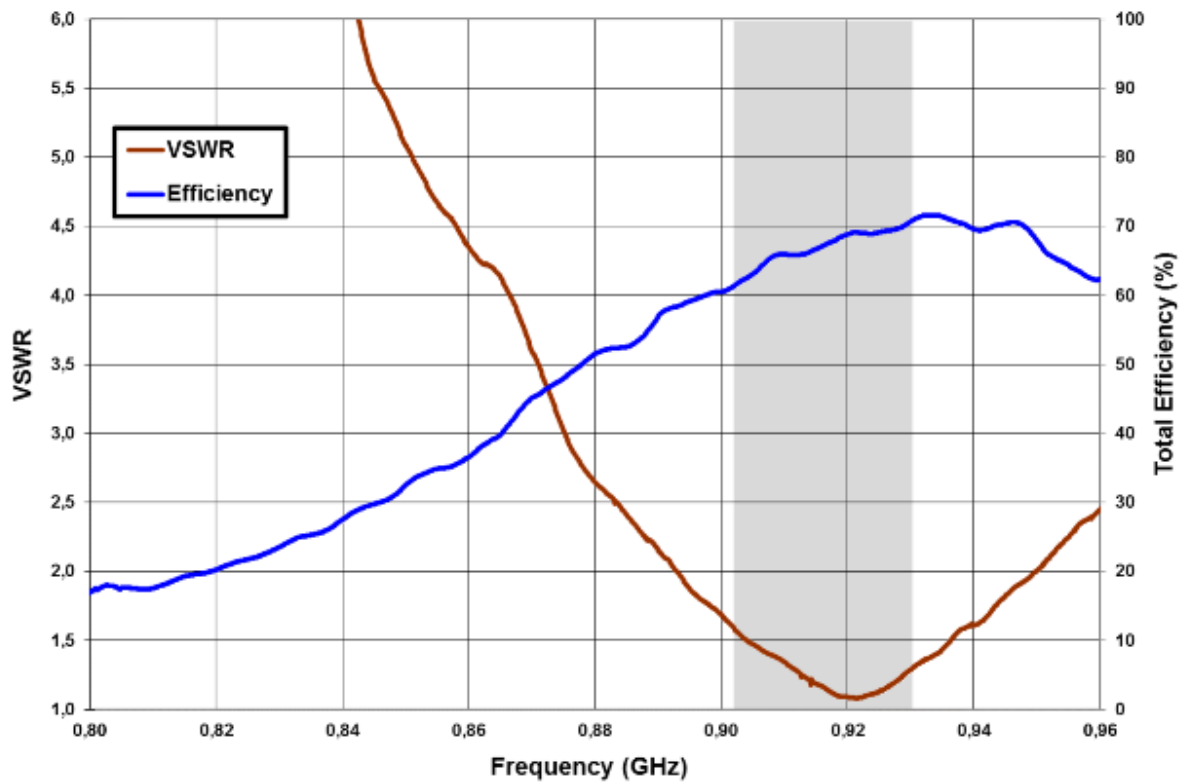

**Figure 15** – VSWR and Total Efficiency for the 902 – 928 MHz from the evaluation board (Figure 13).



## 6.5. RADIATION PATTERNS (902-928 MHz), GAIN AND EFFICIENCY

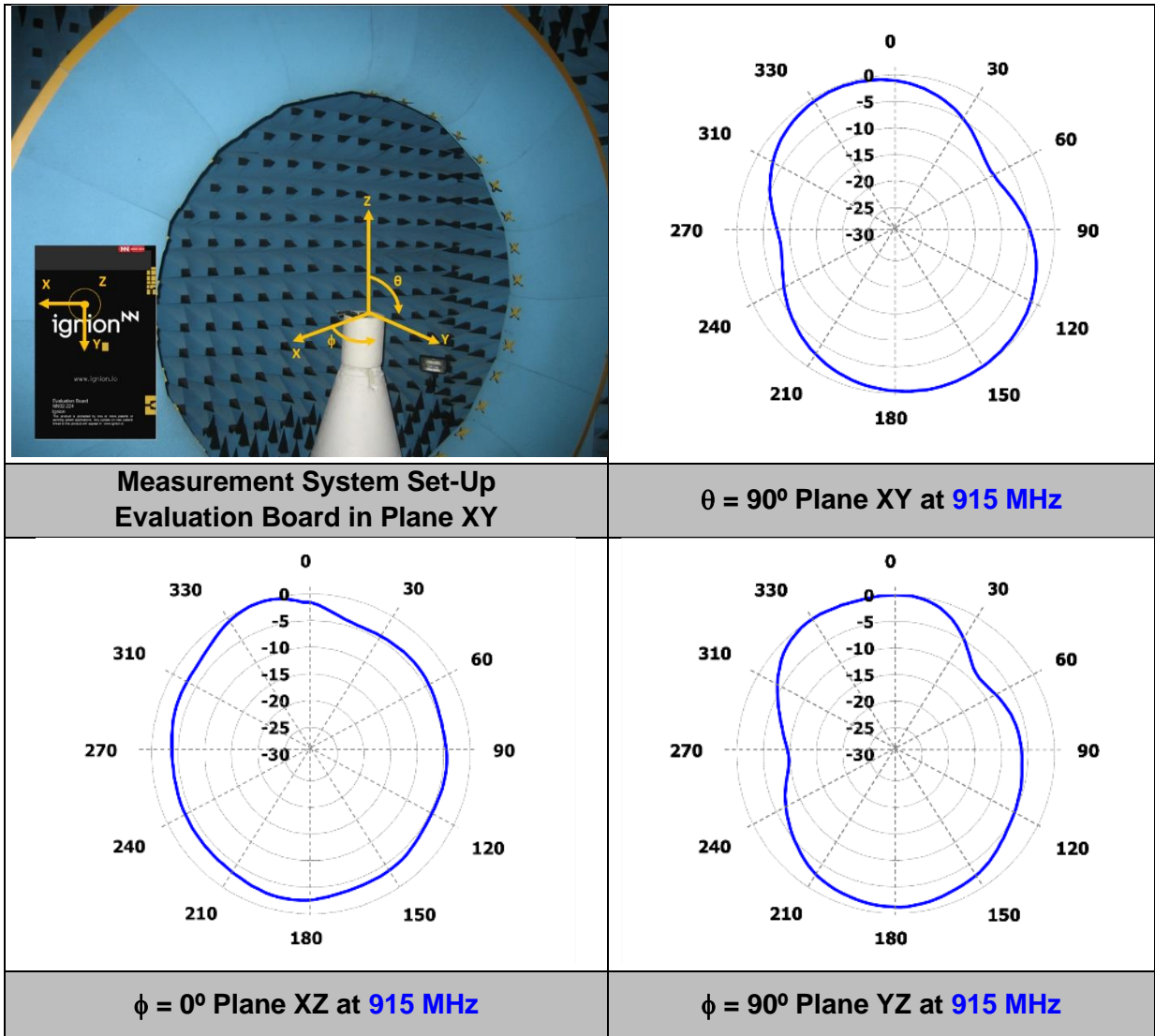

<b>Gain</b>	<b>Peak Gain</b>	0.6 dBi
	<b>Average Gain across the band</b>	0.4 dBi
	<b>Gain Range across the band (min, max)</b>	0.1 $\leftrightarrow$ 0.6 dBi
<b>Efficiency</b>	<b>Peak Efficiency</b>	70.6 %
	<b>Average Efficiency across the band</b>	67.4 %
	<b>Efficiency Range across the band (min, max)</b>	62.7 – 70.6 %

**Table 10** – Antenna Gain and Total Efficiency from the evaluation board (Figure 1) within the 902 – 928 MHz frequency range. Measures made in the Satimo STARGATE 32 anechoic chamber.

## 7. EVALUATION BOARD CR80 863-928 MHz

### 7.1. QUICK REFERENCE GUIDE

Technical features	863 – 928 MHz
Average Efficiency	> 55.0 %
Peak Gain	0.4 dBi
VSWR	< 2.5:1
Radiation Pattern	Omnidirectional
Polarization	Linear
Weight (approx.)	0.19 g
Temperature	-40 to +125 °C
Impedance	50 Ω
Dimensions (L x W x H)	12.0 mm x 3.0 mm x 2.4 mm

Table 11 – Technical Features. Measures from the evaluation board. See Figure 16.

### 7.2. EVALUATION BOARD

This Evaluation Board EB\_NN02-224-CR80-868-915 integrates a UFL cable to connect the RUN mXTEND™ antenna booster with the SMA connector. The RUN mXTEND™ provides operation in the frequency region which covers from 863 MHz to 928 MHz, through a single input/output port.

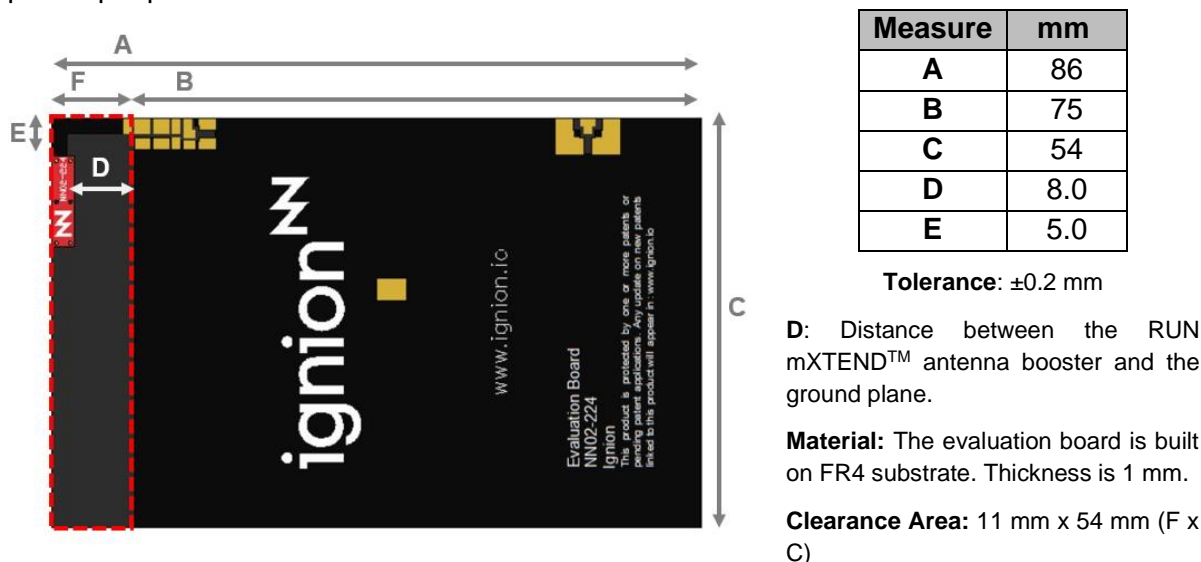
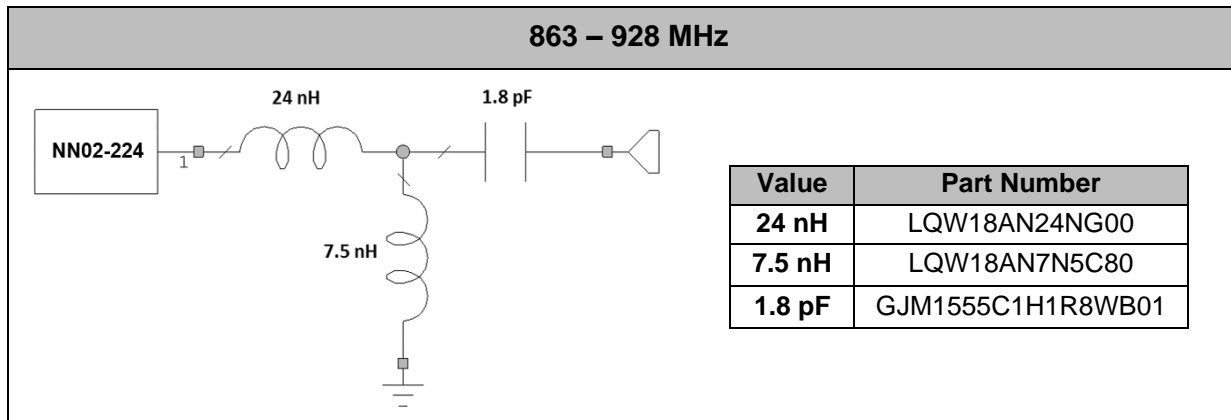

Figure 16 – EB\_NN02-224-CR80-868-915. Evaluation Board providing operation from 863 MHz to 928 MHz.

This product and its use is protected by at least one or more of the following [patents and patent applications](#) US 8,203,492; US 8,237,615; PCT/EP2013/064692; WO2014/012842; US 62/028,494; US 62/072,671; and other domestic and international patents pending. Additional information about patents related to this product is available at [www.ignion.io/virtual-antenna/](http://www.ignion.io/virtual-antenna/).

## 7.3. MATCHING NETWORK

The specs of a Ignion standard product are measured in their evaluation board, which is an ideal case. In a real design, components nearby the antenna, LCD's, batteries, covers, connectors, etc. affect the antenna performance. This is the reason why it is highly recommended placing pads compatible with 0402 and 0603 SMD components for a matching network as close as possible to the feeding point. Do it in the ground plane area, not in the clearance area. This provides a degree of freedom to tune the RUN mXTEND™ antenna booster once the design is finished and taking into account all elements of the system (batteries, displays, covers, etc.). Please note that different devices with different ground planes and different components nearby the RUN mXTEND™ antenna booster may need a different matching network. To ensure optimal results, the use of high Q and tight tolerance components is highly recommended (Murata components). Please, if you need assistance contact [support@ignion.io](mailto:support@ignion.io) for more information related to the antenna booster matching service.



**Figure 17** – Matching Network implemented in the evaluation board (Figure 16)

For additional information, please visit [www.ignion.io](http://www.ignion.io) or contact [info@ignion.io](mailto:info@ignion.io).

If you need assistance to design your matching network, please contact [support@ignion.io](mailto:support@ignion.io), or try our free-of-charge<sup>1</sup> **NN Wireless Fast-Track** design service, you will get your chip antenna design including a custom matching network for your device in 24h<sup>6</sup>. Other related to NN's range of R&D services is available at: <https://www.ignion.io/rdservices/>

<sup>6</sup> See terms and conditions for a free NN Wireless Fast-Track service in 24h at: <https://www.ignion.io/fast-track-project/>

## 7.4. VSWR AND TOTAL EFFICIENCY

VSWR (Voltage Standing Wave Ratio) and Total Efficiency versus Frequency (GHz).

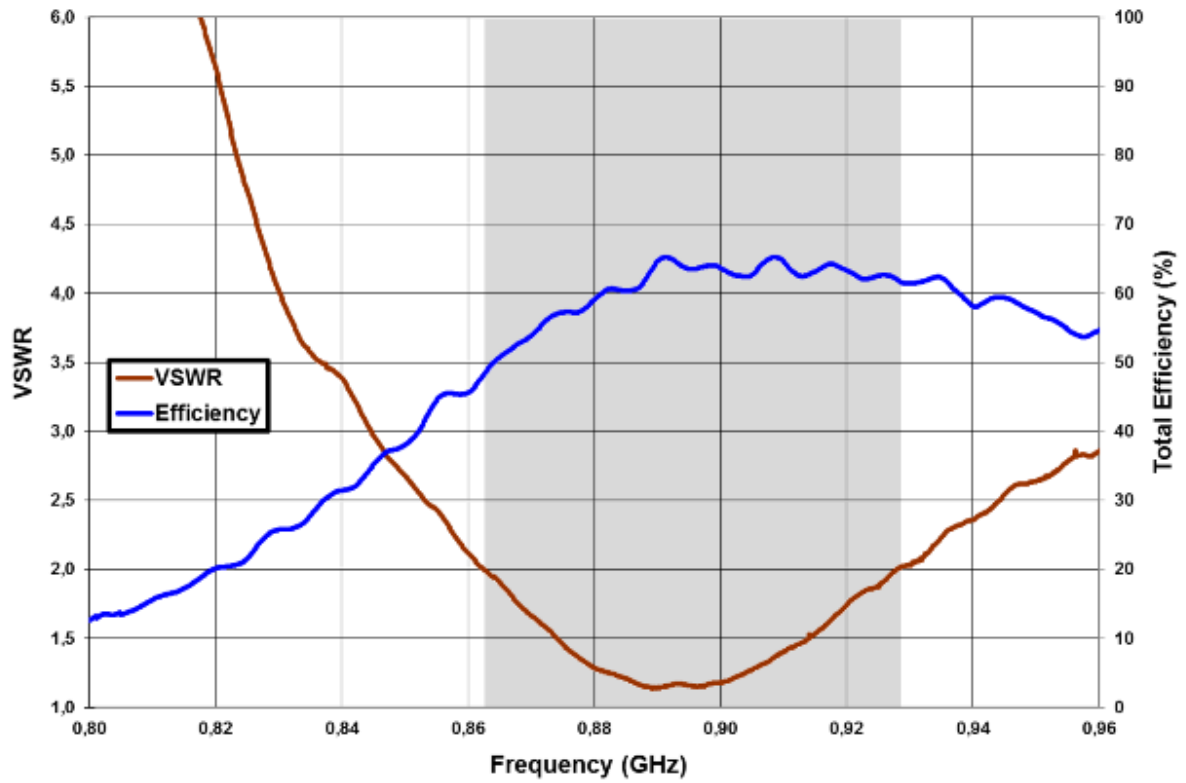

**Figure 18** – VSWR and Total Efficiency for the 863 – 928 MHz from the evaluation board (Figure 16).

## 7.5. RADIATION PATTERNS (863-928 MHz), GAIN AND EFFICIENCY

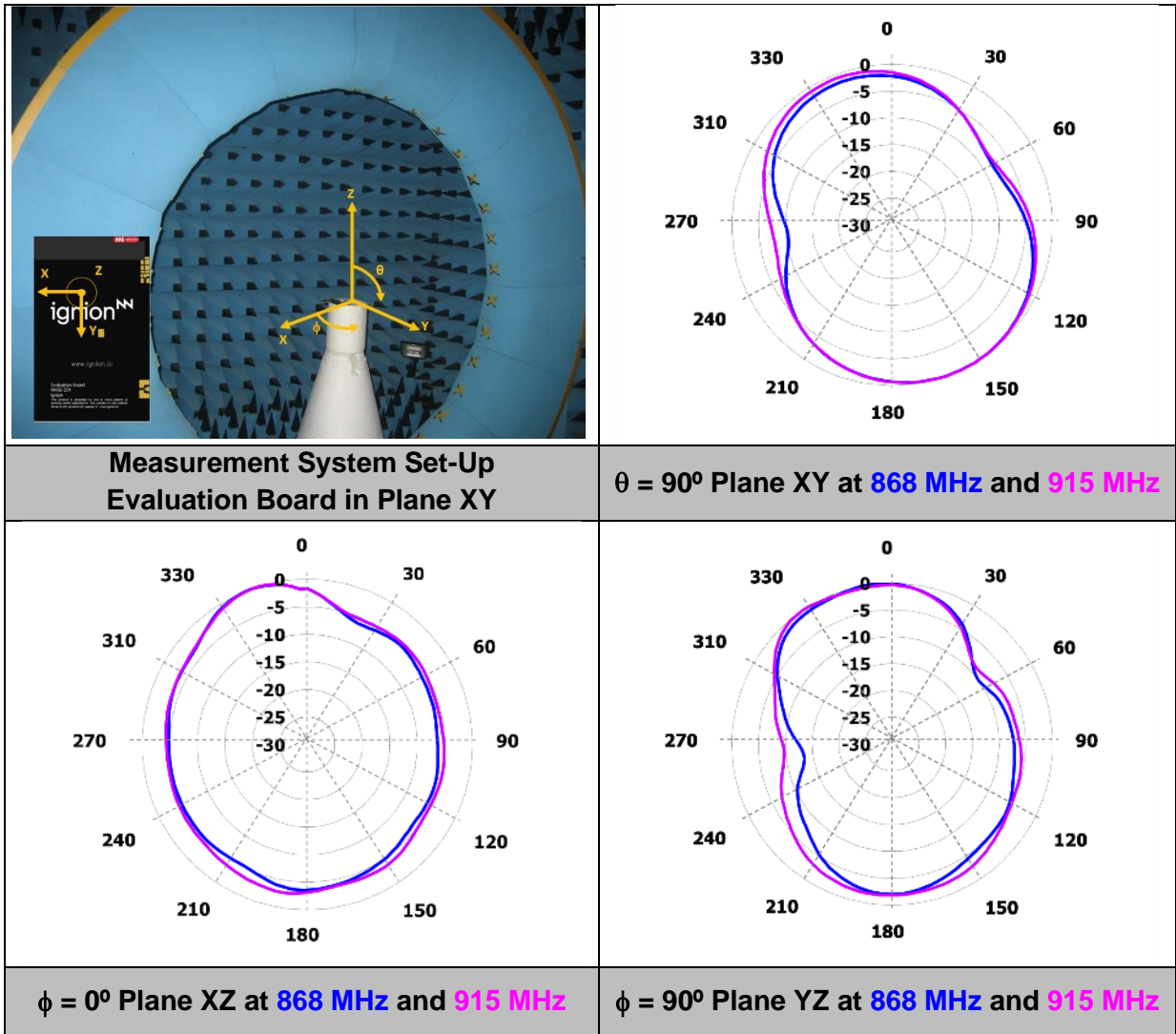

Gain	Peak Gain	0.4 dBi
	Average Gain across the band	-0.1 dBi
	Gain Range across the band (min, max)	-1.0 <--> 0.4 dBi
Efficiency	Peak Efficiency	67.3 %
	Average Efficiency across the band	61.2 %
	Efficiency Range across the band (min, max)	50.8 – 67.3 %

**Table 12** – Antenna Gain and Total Efficiency from the evaluation board (Figure 16) within the 863 – 928 MHz frequency range. Measures made in the Satimo STARGATE 32 anechoic chamber.