

ignion<sup>™</sup>

Your innovation.  
Accelerated.

# CUBE mXTEND<sup>™</sup>: THREE PORT ANTENNA SOLUTION FOR MOBILE FREQUENCY BANDS

APPLICATION NOTE  
CUBE mXTEND<sup>™</sup> (NN02-250)

## CUBE mXTEND<sup>™</sup>: THREE PORT SOLUTION FOR MOBILE FREQUENCY BANDS

Ignion specializes in enabling effective mobile communications. Using Ignion technology, we design and manufacture optimized antennas to make your wireless devices more competitive. Our mission is to help our clients develop innovative products and accelerate their time to market through our expertise in antenna design, testing and manufacturing.

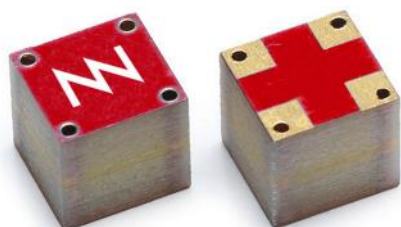

CUBE mXTEND<sup>™</sup> antenna booster

NN02-250

Ignion products are protected by [Ignion patents](#).

All information contained within this document is property of Ignion and is subject to change without prior notice. Information is provided “as is” and without warranties. It is prohibited to copy or reproduce this information without prior approval.

Ignion is an ISO 9001:2015 certified company. All our antennas are lead-free and RoHS compliant.

ISO 9001: 2015 Certified



## TABLE OF CONTENTS

<b>1. ANTENNA DESCRIPTION</b>	<b>4</b>
<b>2. EVALUATION BOARDS 3 PORTS (698-798 MHz &amp; 824-960 MHz &amp; 1710-2690 MHz)5</b>	
<b>2.1. QUICK REFERENCE GUIDE: UFL CABLES</b>	<b>5</b>
<b>2.2. QUICK REFERENCE GUIDE: COPLANAR GROUNDED TRANSMISSION LINES</b>	<b>5</b>
<b>2.3. EVALUATION BOARD 3 PORTS (UFL CABLES)</b>	<b>6</b>
<b>2.4. MATCHING NETWORK</b>	<b>7</b>
<b>2.5. VSWR and TOTAL Efficiency</b>	<b>8</b>
<b>2.6. TRANSMISSION COEFFICIENT</b>	<b>9</b>
<b>2.7. RADIATION PATTERNS (698-798 MHZ), GAIN AND EFFICIENCY</b>	<b>10</b>
<b>2.8. RADIATION PATTERNS (824-960 MHZ), GAIN AND EFFICIENCY</b>	<b>11</b>
<b>2.9. RADIATION PATTERNS (1710-2690 MHZ), GAIN AND EFFICIENCY</b>	<b>12</b>
<b>3. EVALUATION BOARD 3 PORTS (COPLANAR GROUNDED TRANSMISSION LINES)</b>	<b>13</b>
<b>3.1. MATCHING NETWORK</b>	<b>14</b>
<b>3.2. VSWR and TOTAL Efficiency</b>	<b>15</b>
<b>3.3. TRANSMISSION COEFFICIENT</b>	<b>16</b>
<b>3.4. RADIATION PATTERNS (698-798 MHZ), GAIN AND EFFICIENCY</b>	<b>17</b>
<b>3.5. RADIATION PATTERNS (824-960 MHZ), GAIN AND EFFICIENCY</b>	<b>18</b>
<b>3.6. RADIATION PATTERNS (1710-2690 MHZ), GAIN AND EFFICIENCY</b>	<b>19</b>
<b>4. ANTENNA FOOTPRINT</b>	<b>20</b>

# 1. ANTENNA DESCRIPTION

The CUBE mXTEND<sup>™</sup> antenna booster component has been specifically designed for providing multiband performance in wireless devices (in particular in mobile devices), enabling worldwide coverage by allowing operation in the communication standards GSM850, GSM900, GSM1800/DCS, GSM1900/PCS, UMTS, LTE700, LTE800, LTE850, LTE900, LTE1700, LTE1800, LTE1900, LTE2000, LTE2100, LTE2300, LTE2500, and LTE2600.



**Material:** The CUBE mXTEND<sup>™</sup> antenna booster is built on glass epoxy substrate.

## APPLICATIONS

- Handsets
- Smartphones
- Tablets
- Phablets
- Laptop PCs
- Netbooks
- Modules
- Routers
- eBooks

## BENEFITS

- High efficiency
- Small size
- Cost-effective
- Easy-to-use (pick and place)
- Multiband behaviour (worldwide standards)
- Off-the-Shelf Standard Product (no customization is required)

The CUBE mXTEND<sup>™</sup> antenna booster belongs to a new generation of antenna solutions based on the Virtual Antenna<sup>™</sup> technology owned by Ignion. The technology is mainly focused on replacing conventional antenna solutions by miniature and standard components.

## 2. EVALUATION BOARDS 3 PORTS (698-798 MHz & 824-960 MHz & 1710-2690 MHz)

### 2.1. QUICK REFERENCE GUIDE: UFL CABLES

Technical features	698 – 798 MHz	824 – 960 MHz	1710 – 2690 MHz
Average Efficiency	> 45 %	> 50 %	> 70 %
Peak Gain	0.6 dBi	0.6 dBi	3.2 dBi
VSWR	< 3:1		
Radiation Pattern	Omnidirectional		
Polarization	Linear		
Weight (approx.)	0.25 g		
Temperature	-40 to +125 °C		
Impedance	50 Ω		
Dimensions (L x W x H)	5.0 mm x 5.0 mm x 5.0 mm		

Table 1 – Technical features. Measures from the Evaluation Board. See Figure 1.

### 2.2. QUICK REFERENCE GUIDE: COPLANAR GROUNDED TRANSMISSION LINES

Technical features	698 – 798 MHz	824 – 960 MHz	1710 – 2690 MHz
Average Efficiency	> 40 %	> 45 %	> 70 %
Peak Gain	-0.2 dBi	1.0 dBi	3.4 dBi
VSWR	< 3:1		
Radiation Pattern	Omnidirectional		
Polarization	Linear		
Weight (approx.)	0.25 g		
Temperature	-40 to +125 °C		
Impedance	50 Ω		
Dimensions (L x W x H)	5.0 mm x 5.0 mm x 5.0 mm		

Table 2 – Technical features. Measures from the Evaluation Board. See Figure 5.

#### Comments:

- Note that in the Evaluation Boards (Figure 1 and Figure 5), 2 CUBE mXTEND™ antenna boosters are placed together to provide operation at LTE700 (698 – 798 MHz). Please see Figure 9 for the recommended footprint.
- The efficiency measures (Figure 3 and Figure 7) are shown from 700 MHz due to the minimum frequency specifications of the Satimo STARGATE 32 anechoic chamber.
- Note that for obtaining comparable results, a ground plane length larger than 100 mm is recommended.
- Please contact [support@ignion.io](mailto:support@ignion.io) for more information related to the antenna booster matching service.

### 2.3. EVALUATION BOARD 3 PORTS (UFL CABLES)

This Evaluation Board (part number: EB\_NN02-250-UFL3R) integrates UFL cables to connect the CUBE mXTEND™ antenna boosters with the SMA connector. It works from 698 MHz to 798 MHz, from 824 MHz to 960 MHz, and from 1710 MHz to 2690 MHz. In the next section (3) there is another version of the Evaluation Board where the connections are made through coplanar grounded transmission lines (traces on a PCB) to connect the CUBE mXTEND™ antenna boosters with the SMA connector.



Measure	mm
A	133
B	120
C	60
D	6.5
E	1.5

**Tolerance:** ±0.2 mm

**Material:** The Evaluation Board is built on FR4 substrate. Thickness is 1 mm.

**E:** Distance between the CUBE mXTEND™ antenna booster and the ground plane

**Clearance Area:** 60 mm x 13 mm (Cx D)

**Figure 1** – EB\_NN02-250-UFL3R. Evaluation Board with UFL cables. 698 MHz to 798 MHz, 824 MHz to 960 MHz, and 1710 MHz to 2690 MHz.

This product is protected by at least the following [patent](#) PAT. US 8,203,492, PAT. US 8,736,497, and other domestic and international patents pending. Any update on new patents linked to this product will appear in [www.ignion.io/virtual-antenna/](http://www.ignion.io/virtual-antenna/).

## 2.4. MATCHING NETWORK

The specs of a Ignion standard product are measured in their Evaluation Board, which is an ideal case. In a real design, components nearby the antenna, LCD's, batteries, covers, connectors, etc. affect the antenna performance. This is the reason why it is highly recommended placing pads compatible with 0402 and 0603 SMD components for a matching network as close as possible to the feeding point. Do it in the ground plane area, not in the clearance area. This provides a degree of freedom to tune the CUBE mXTEND™ antenna booster once the design is finished and considering all elements of the system.

Please notice that different devices with different ground planes and components nearby the CUBE mXTEND™ antenna booster may need a different matching network. To ensure optimal results, the use of high Q and tight tolerance components is highly recommended (Murata components). If you need assistance to design your matching network beyond this application note, please contact [support@ignion.io](mailto:support@ignion.io), or try our free-of-charge<sup>1</sup> **NN Wireless Fast-Track** design service, you will get your chip antenna design including a custom matching network for your device in 24h<sup>1</sup>. Other related to NN's range of R&D services is available at: <https://www.ignion.io/rdservices/>

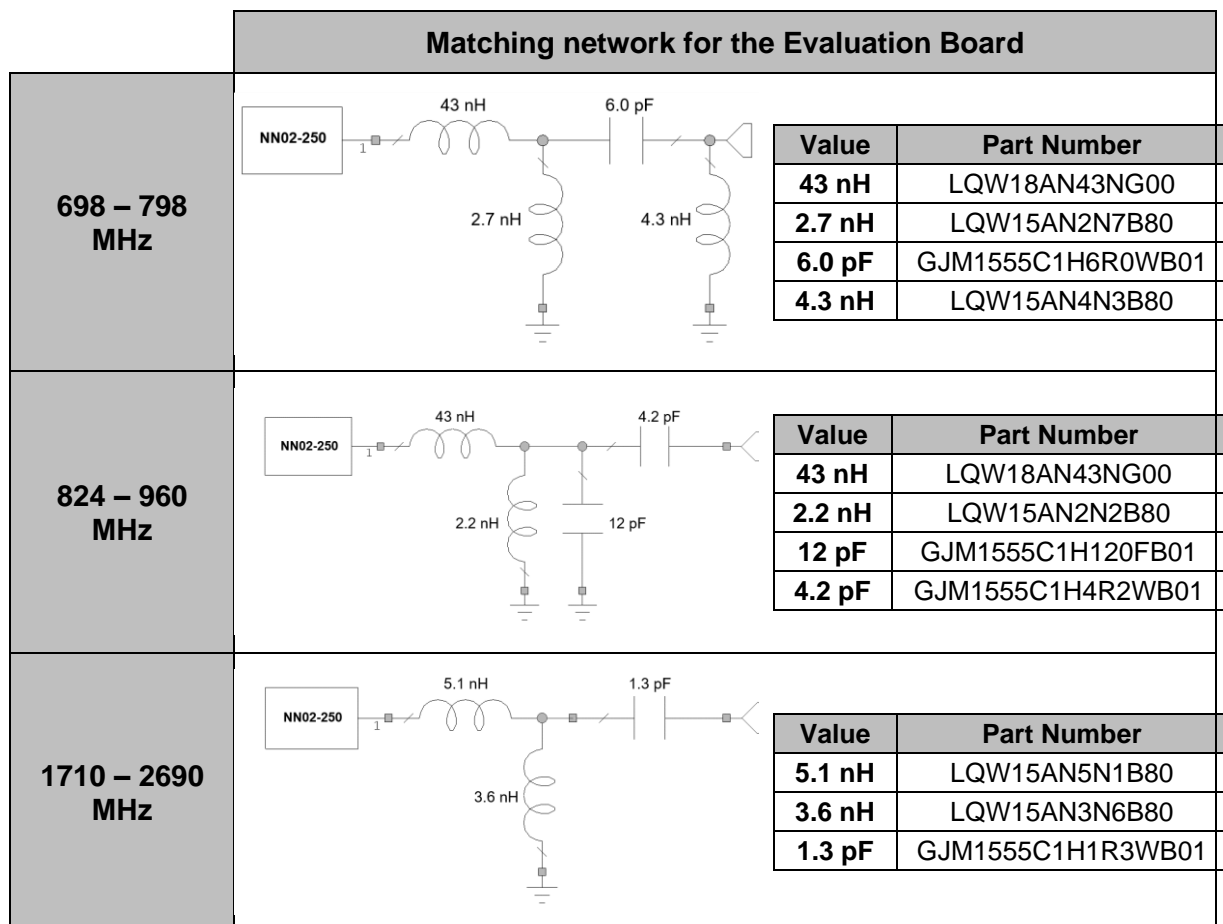
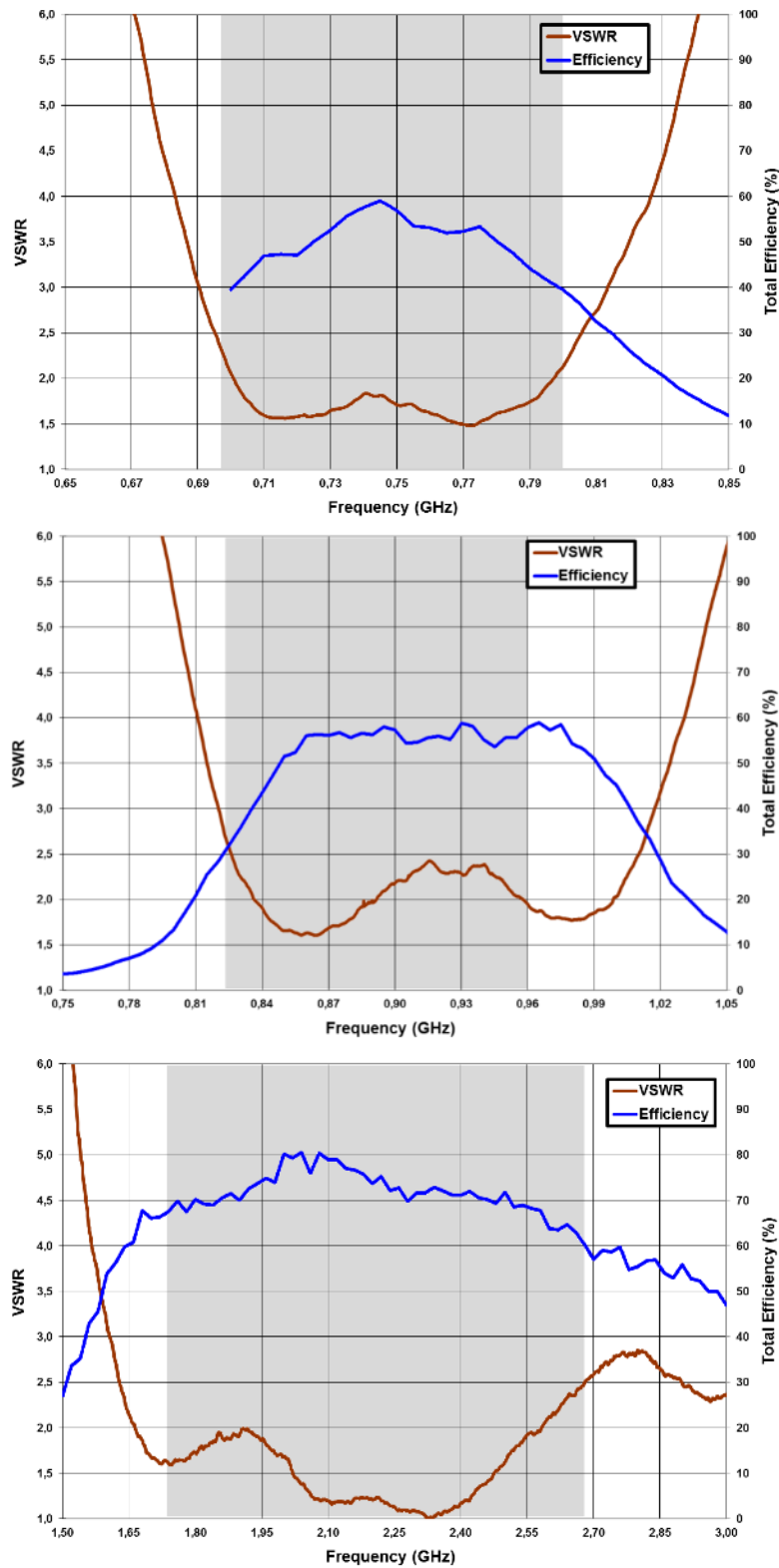

**Figure 2** – Matching networks for the 3 ports solution (Evaluation Board with UFL cables).

<sup>1</sup> See terms and conditions for a free NN Wireless Fast-Track service in 24h at: <https://www.ignion.io/fast-track-project/>

## 2.5. VSWR and TOTAL Efficiency

VSWR (Voltage Standing Wave Ratio) and Total Efficiency versus Frequency (GHz).



**Figure 3** – VSWR and Total Efficiency for the 698 – 798 MHz range, for the 824 – 960 MHz range, and for the 1710 – 2690 MHz range (from the Evaluation Board with UFL cables (Figure 1)).



## 2.6. TRANSMISSION COEFFICIENT

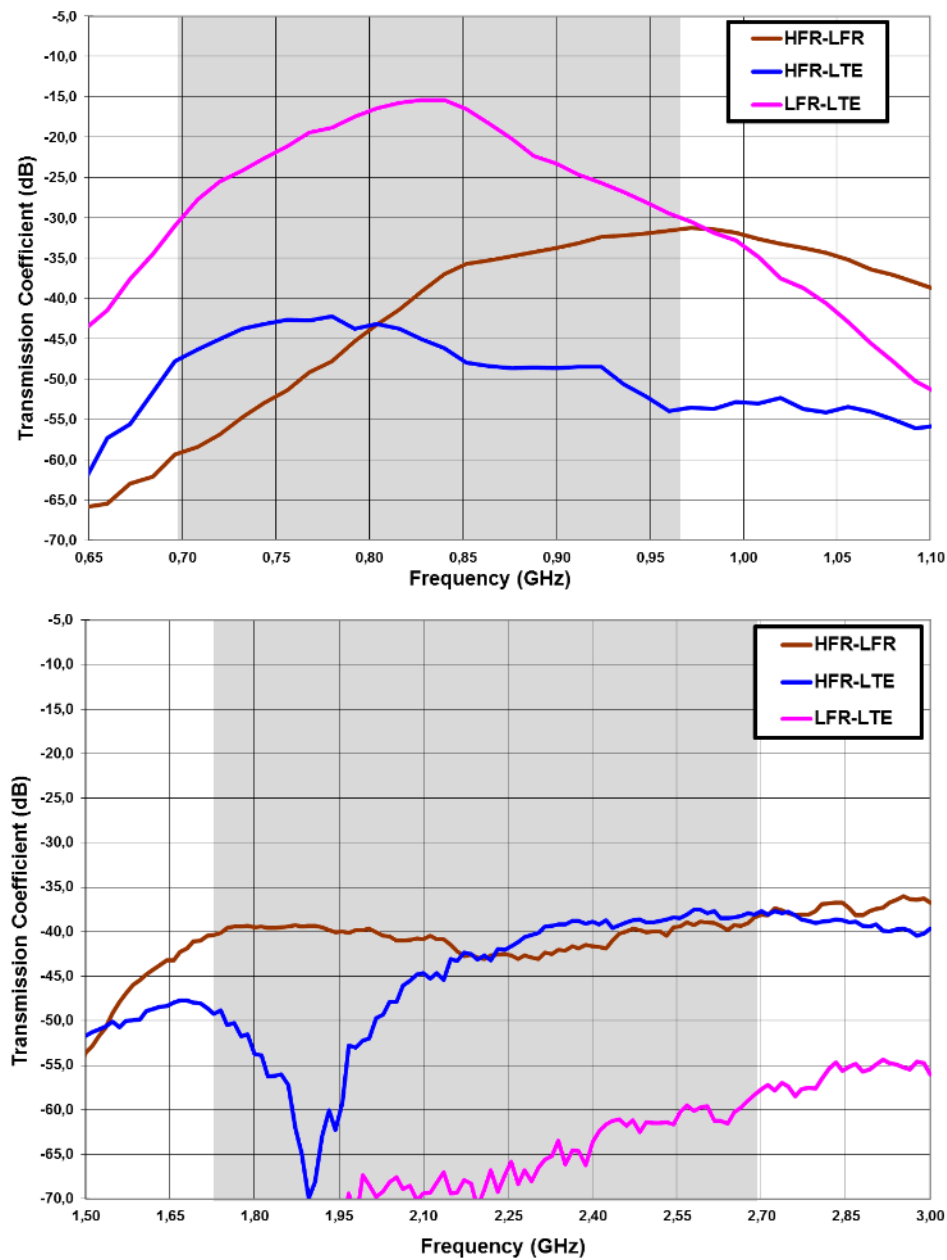

**Figure 4** – Transmission coefficient for the 698 – 798 MHz range (LTE), for the 824 – 960 MHz range (LFR), and for the 1710 – 2690 MHz range (HFR) (from the Evaluation Board 3 ports with UFL cables) (Figure 1).

## 2.7. RADIATION PATTERNS (698-798 MHZ), GAIN AND EFFICIENCY

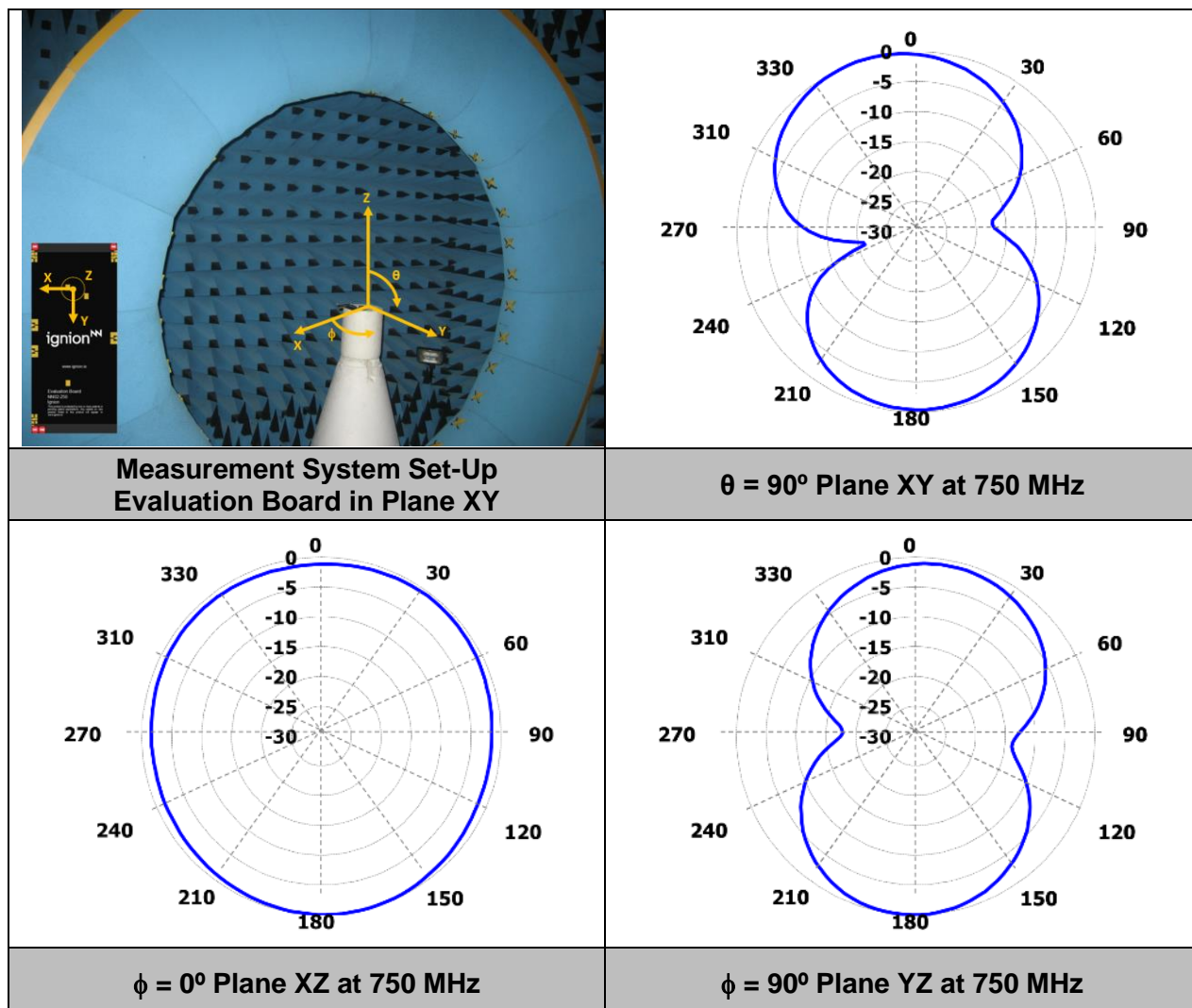

<b>Gain</b>	<b>Peak Gain</b>	0.6 dBi
	<b>Average Gain across the band</b>	-0.2 dBi
	<b>Gain Range across the band (min, max)</b>	-1.5 ↔ 0.6 dBi
<b>Efficiency</b>	<b>Peak Efficiency</b>	59.0 %
	<b>Average Efficiency across the band</b>	50.3 %
	<b>Efficiency Range across the band (min, max)</b>	39.5 – 59.0 %

**Table 3** – Antenna Gain and Total Efficiency for the Evaluation Board EB\_NN02-250-UFL3R within the 698 – 798 MHz range. Measures made in the Satimo STARGATE 32 anechoic chamber.

## 2.8. RADIATION PATTERNS (824-960 MHZ), GAIN AND EFFICIENCY

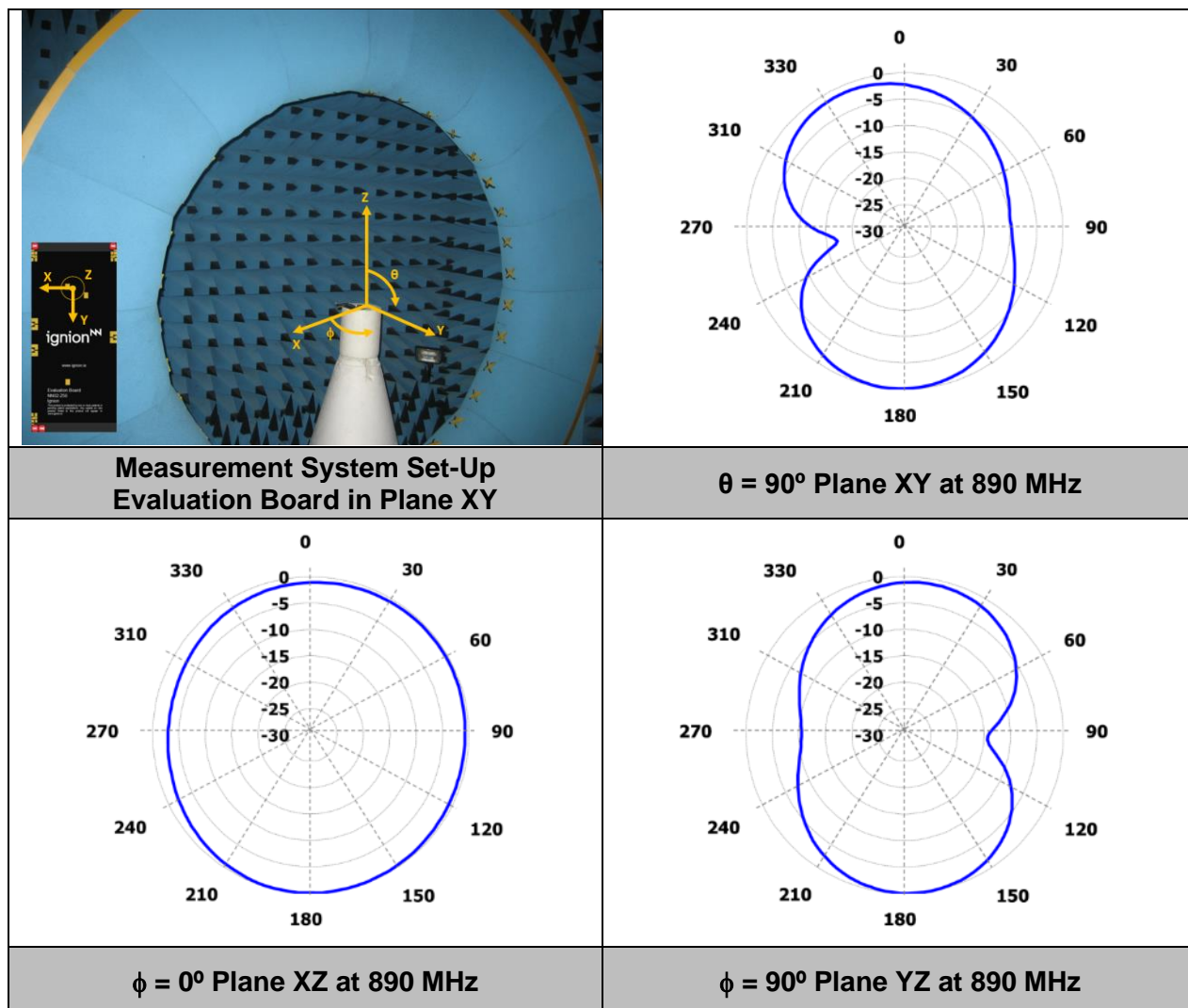

<b>Gain</b>	<b>Peak Gain</b>	0.6 dBi
	<b>Average Gain across the band</b>	0.0 dBi
	<b>Gain Range across the band (min, max)</b>	-2.1 ↔ 0.6 dBi
<b>Efficiency</b>	<b>Peak Efficiency</b>	58.8 %
	<b>Average Efficiency across the band</b>	53.1 %
	<b>Efficiency Range across the band (min, max)</b>	31.2 – 58.8 %

**Table 4** – Antenna Gain and Total Efficiency within the 824 – 960 MHz range. Measures made in the Satimo STARGATE 32 anechoic chamber.

## 2.9. RADIATION PATTERNS (1710-2690 MHZ), GAIN AND EFFICIENCY

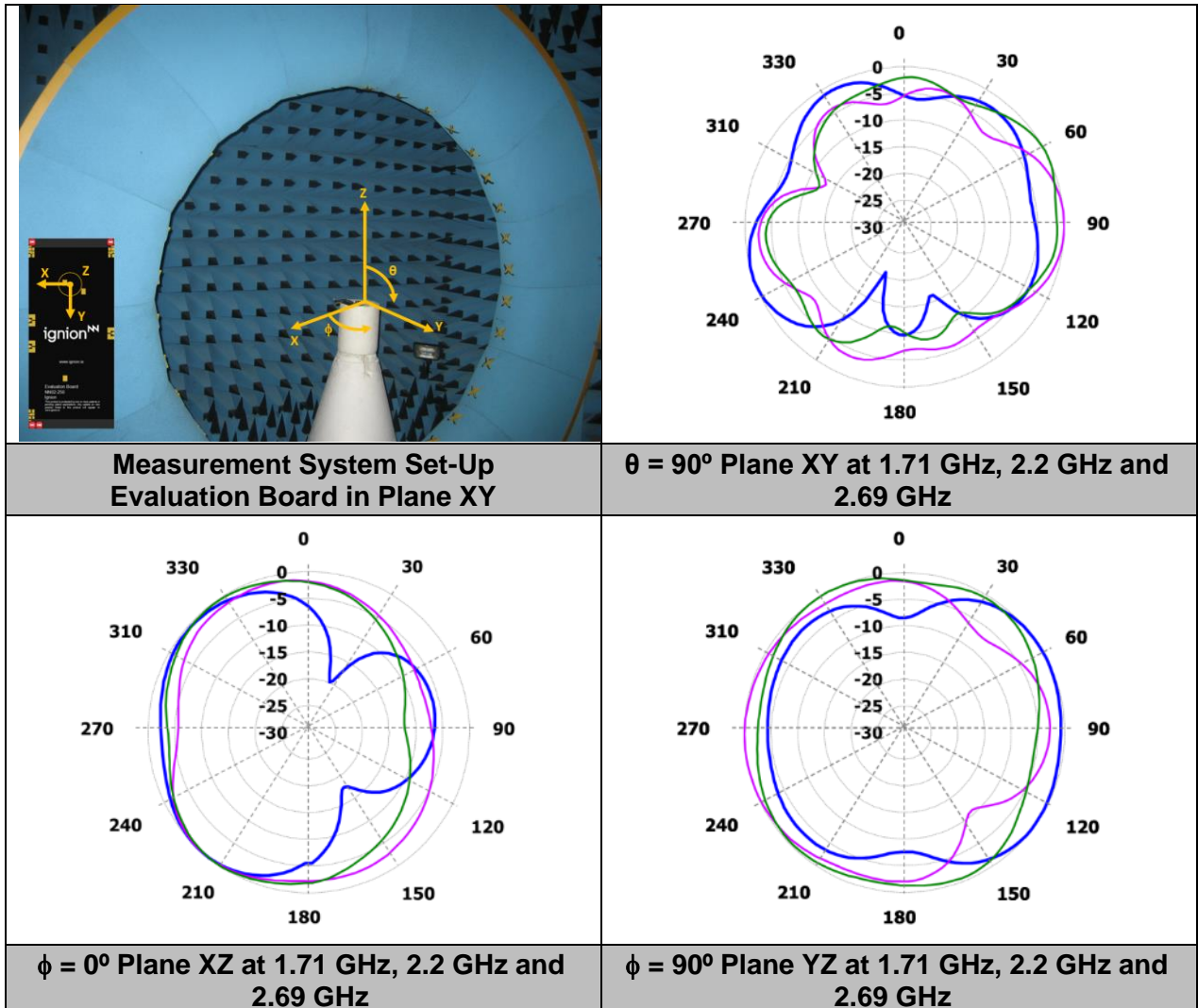

<b>Gain</b>	<b>Peak Gain</b>	3.2 dBi
	<b>Average Gain across the band</b>	2.5 dBi
	<b>Gain Range across the band (min, max)</b>	1.7 $\leftrightarrow$ 3.2 dBi
<b>Efficiency</b>	<b>Peak Efficiency</b>	80.5 %
	<b>Average Efficiency across the band</b>	71.5 %
	<b>Efficiency Range across the band (min, max)</b>	58.5 – 80.5 %

**Table 5** – Antenna Gain and Total Efficiency within the 1710 – 2690 MHz range. Measures made in the Satimo STARGATE 32 anechoic chamber.

### 3. EVALUATION BOARD 3 PORTS (COPLANAR GROUNDED TRANSMISSION LINES)

This Evaluation Board (part number: EB\_NN02-250-CPW3R) integrates coplanar grounded transmission lines to connect the CUBE mXTEND™ antenna boosters with the SMA connector. It works from 698 MHz to 798 MHz, from 824 MHz to 960 MHz, and from 1710 MHz to 2690 MHz.



Measure	mm
A	133
B	120
C	60
D	6.5
E	1.5

**Tolerance:** ±0.2 mm

**Material:** The Evaluation Board is built on FR4 substrate. Thickness is 1 mm.

**E:** Distance between the CUBE mXTEND™ antenna booster and the ground plane

**Clearance Area:** 60 mm x 13 mm (Cx D)

**Figure 5** – EB\_NN02-250-CPW3R. Evaluation Board with coplanar grounded transmission lines. 698 MHz to 798 MHz, 824 MHz to 960 MHz, and 1710 MHz to 2690 MHz.

This product is protected by at least the following [patents](#) PAT. US 8,203,492, PAT. US 8,736,497, and other domestic and international patents pending. Any update on new patents linked to this product will appear in [www.ignion.io/virtual-antenna/](http://www.ignion.io/virtual-antenna/).

### 3.1. MATCHING NETWORK

The specs of a Ignion standard product are measured in their Evaluation Board, which is an ideal case. In a real design, components nearby the antenna, LCD's, batteries, covers, connectors, etc. affect the antenna performance. This is the reason why it is highly recommended placing pads compatible with 0402 and 0603 SMD components for a matching network as close as possible to the feeding point. Do it in the ground plane area, not in the clearance area. This provides a degree of freedom to tune the CUBE mXTEND™ antenna booster once the design is finished and considering all elements of the series.

Please notice that different devices with different ground planes and components nearby the CUBE mXTEND™ antenna booster may need a different matching network. To ensure optimal results, the use of high Q and tight tolerance components is highly recommended (Murata components). If you need assistance to design your matching network beyond this application note, please contact [support@ignion.io](mailto:support@ignion.io), or try our free-of-charge<sup>1</sup> **NN Wireless Fast-Track** design service, you will get your chip antenna design including a custom matching network for your device in 24h<sup>2</sup>. Other related to NN's range of R&D services is available at: <https://www.ignion.io/rdservices/>

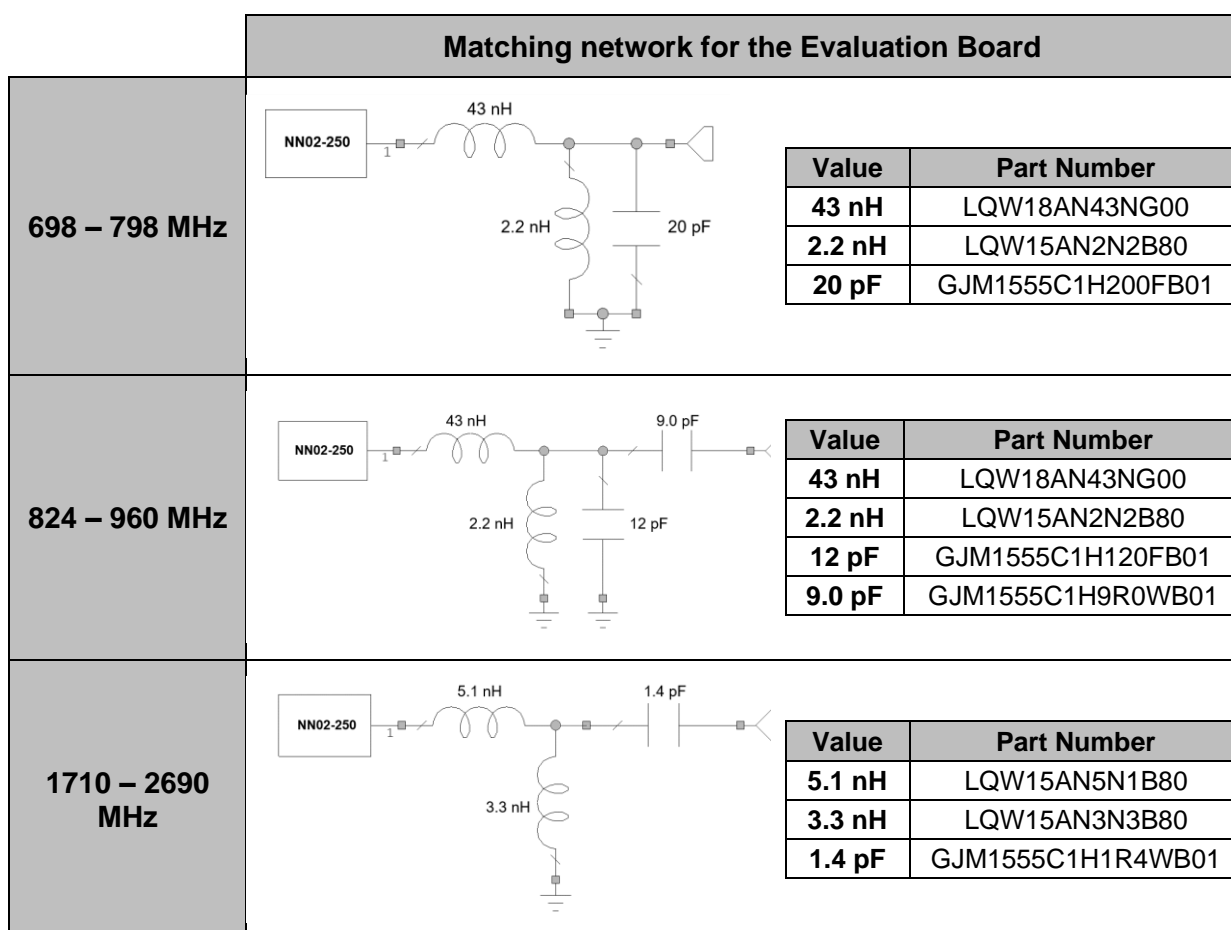

**Figure 6** – Matching networks for the 3 ports solution (Evaluation Board with coplanar transmission lines).

<sup>2</sup> See terms and conditions for a free NN Wireless Fast-Track service in 24h at: <https://www.ignion.io/fast-track-project/>



### 3.2. VSWR and TOTAL Efficiency

VSWR (Voltage Standing Wave Ratio) and Total Efficiency versus Frequency (GHz).

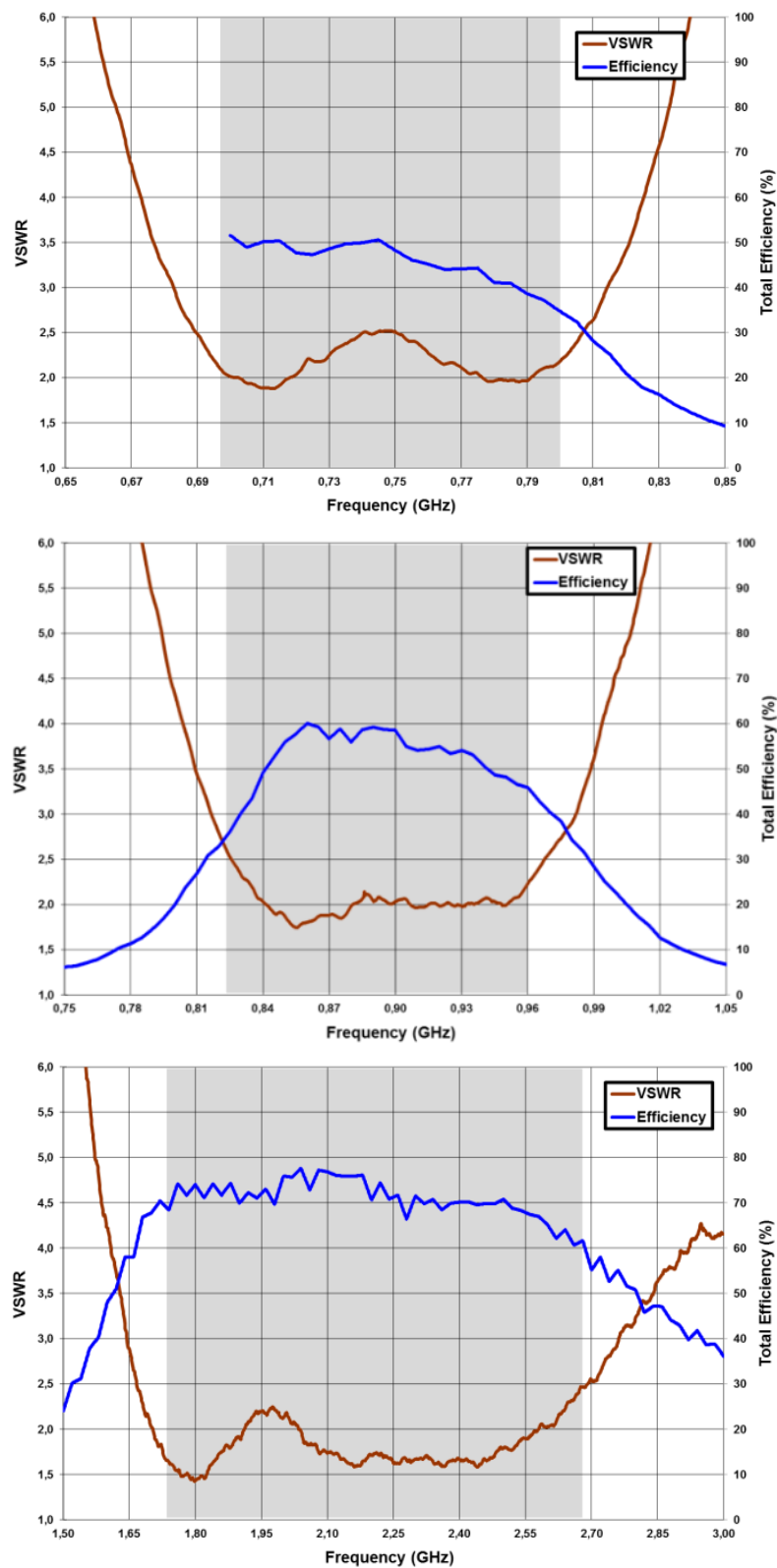

**Figure 7** – VSWR and Total Efficiency graph for the 698 – 798 MHz range, for the 824 – 960 MHz range, and for the 1710 – 2690 MHz range (from the Evaluation Board with coplanar transmission lines (Figure 5)).

### 3.3. TRANSMISSION COEFFICIENT

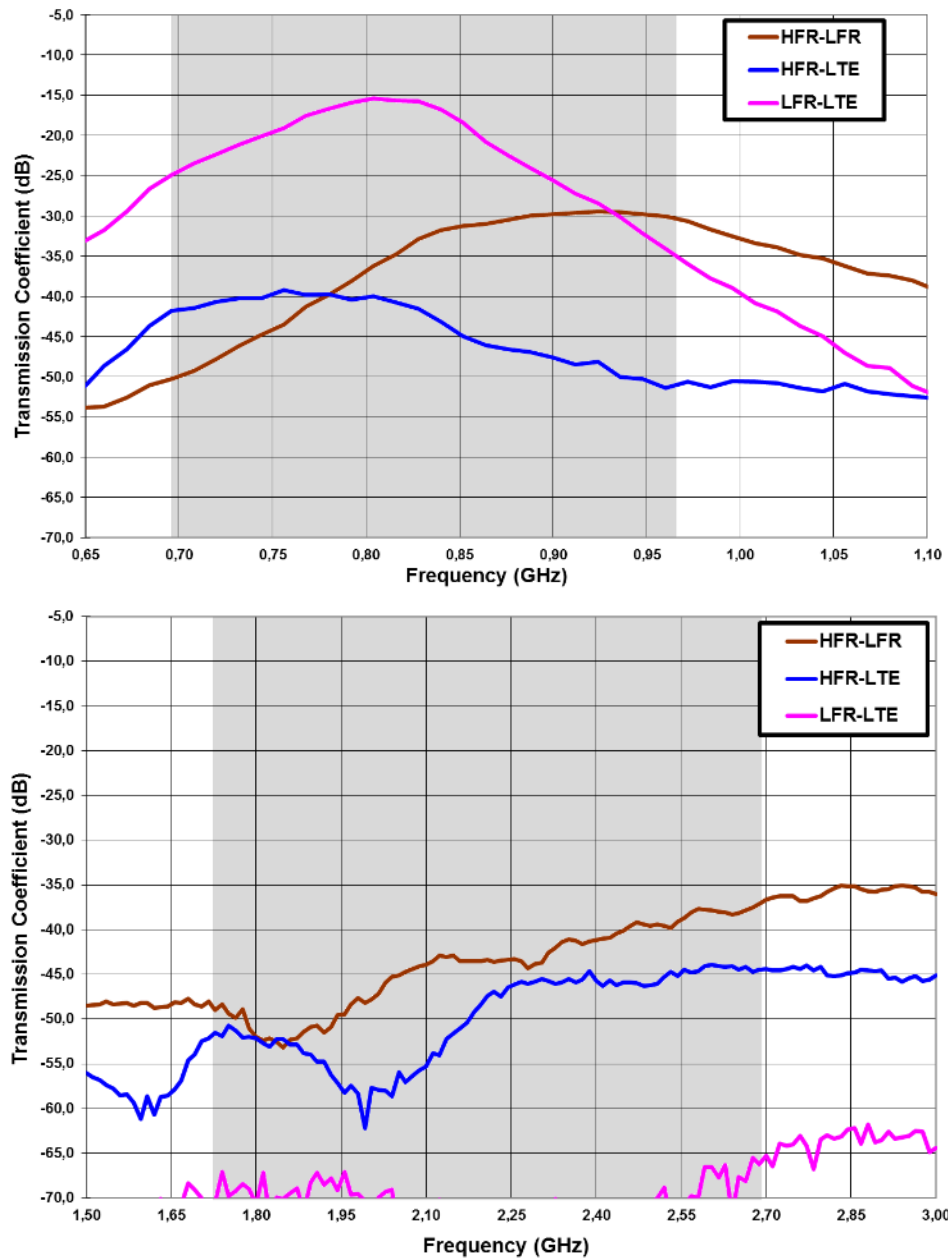

**Figure 8** – Transmission coefficient for the 698 – 798 MHz range (LTE), for the 824 – 960 MHz range (LFR), and for the 1710 – 2690 MHz range (HFR) (from the Evaluation Board with coplanar transmission lines (Figure 5)).



### 3.4. RADIATION PATTERNS (698-798 MHz), GAIN AND EFFICIENCY

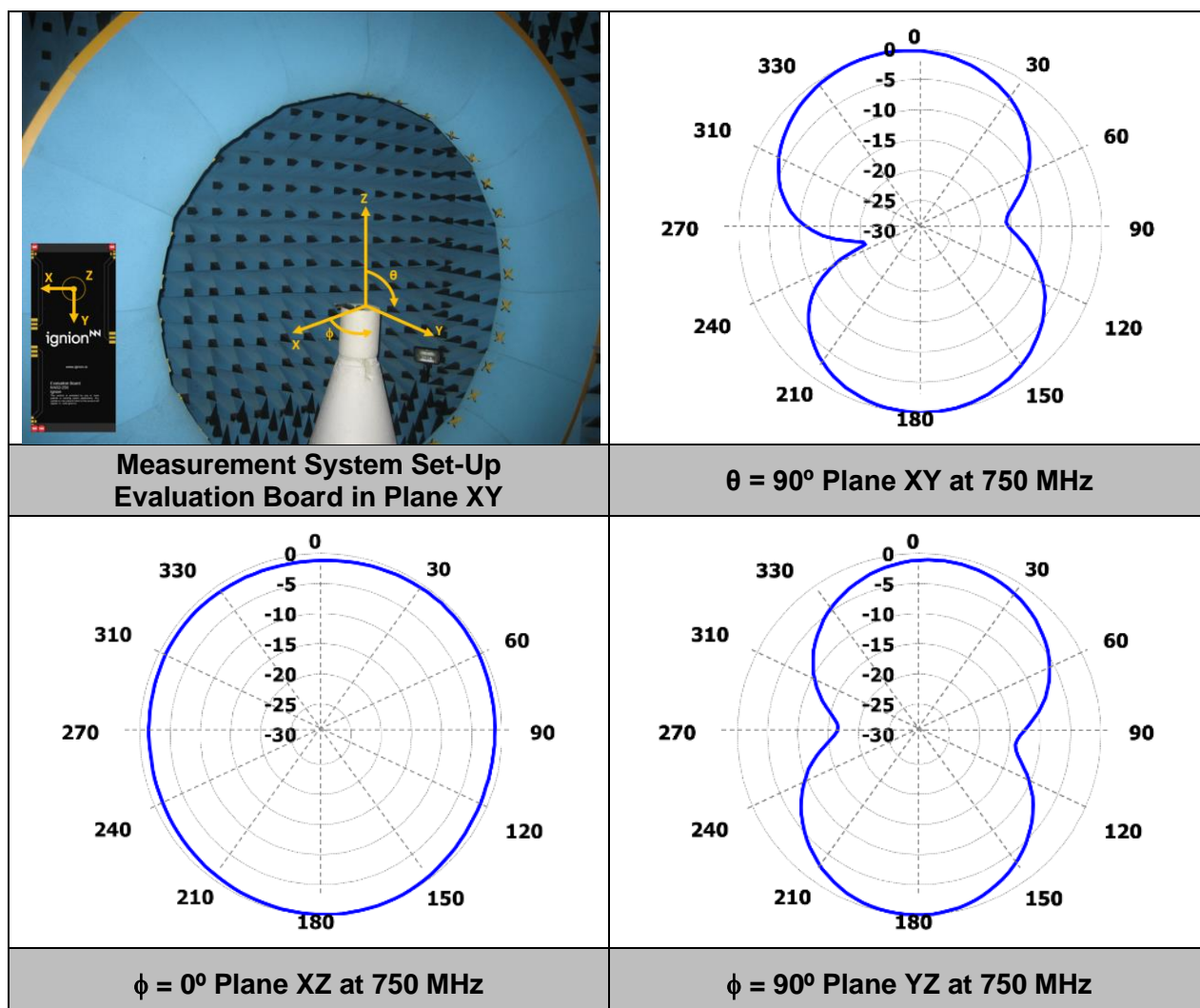

Gain	Peak Gain	-0.2 dBi
	Average Gain across the band	-0.5 dBi
	Gain Range across the band (min, max)	-1.5 <--> -0.2 dBi
Efficiency	Peak Efficiency	51.6 %
	Average Efficiency across the band	46.0 %
	Efficiency Range across the band (min, max)	35.7 – 51.6 %

**Table 6** – Antenna Gain and Total Efficiency for the Evaluation Board EB\_NN02-250-CPW3R within the 698 – 798 MHz range. Measures made in the Satimo STARGATE 32 anechoic chamber.

### 3.5. RADIATION PATTERNS (824-960 MHz), GAIN AND EFFICIENCY

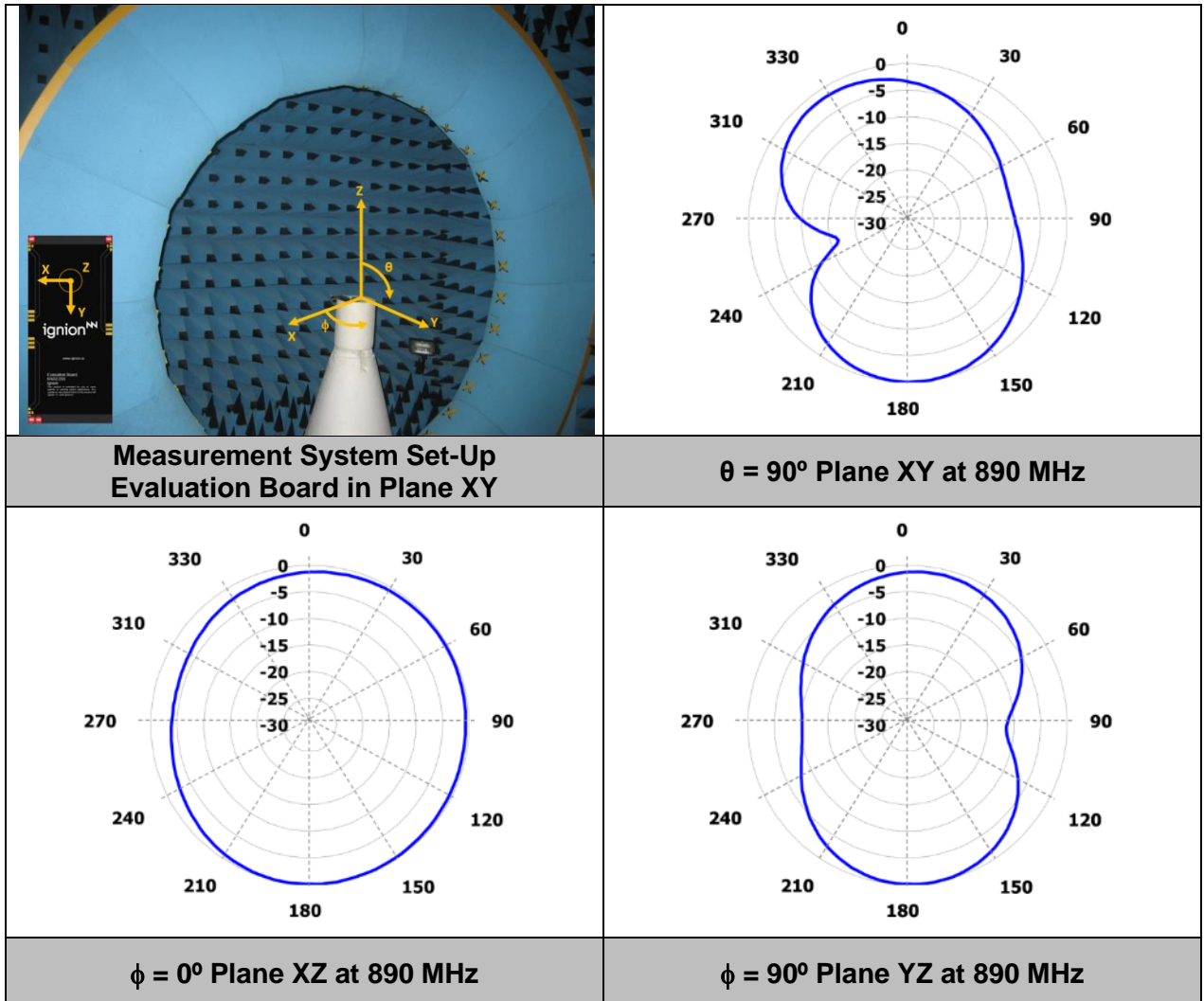

<b>Gain</b>	<b>Peak Gain</b>	1.0 dBi
	<b>Average Gain across the band</b>	0.1 dBi
	<b>Gain Range across the band (min, max)</b>	-1.4 $\leftrightarrow$ 1.0 dBi
<b>Efficiency</b>	<b>Peak Efficiency</b>	60.1 %
	<b>Average Efficiency across the band</b>	53.2 %
	<b>Efficiency Range across the band (min, max)</b>	35.5 – 60.1 %

**Table 7** – Antenna Gain and Total Efficiency within the 824 – 960 MHz range. Measures made in the Satimo STARGATE 32 anechoic chamber.

### 3.6. RADIATION PATTERNS (1710-2690 MHZ), GAIN AND EFFICIENCY

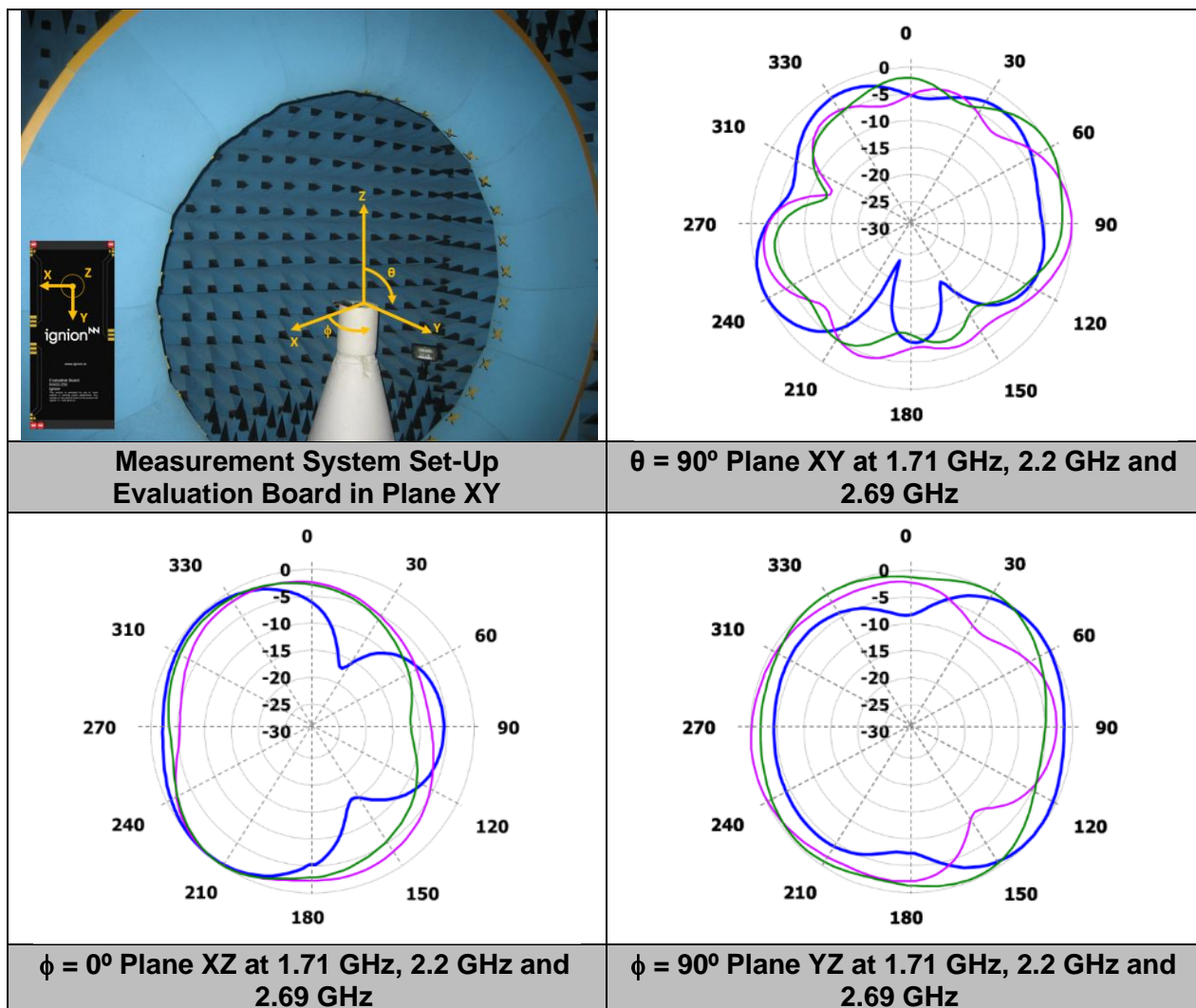

Gain	Peak Gain	3.4 dBi
	Average Gain across the band	2.8 dBi
	Gain Range across the band (min, max)	1.9 ↔ 3.4 dBi
Efficiency	Peak Efficiency	77.6 %
	Average Efficiency across the band	70.9 %
	Efficiency Range across the band (min, max)	58.2 – 70.9 %

**Table 8** – Antenna Gain and Total Efficiency within the 1710 – 2690 MHz range. Measures made in the Satimo STARGATE 32 anechoic chamber.

## 4. ANTENNA FOOTPRINT

Assuming that the CUBE mXTEND<sup>™</sup> antenna booster NN02-250 is placed in the clearance area of the PCB, see below the recommended footprint dimensions.

Measure	mm
A	1.7
B	1.6
C	3.4
D	2.0
E	2.5

**Tolerance:** ±0.2 mm

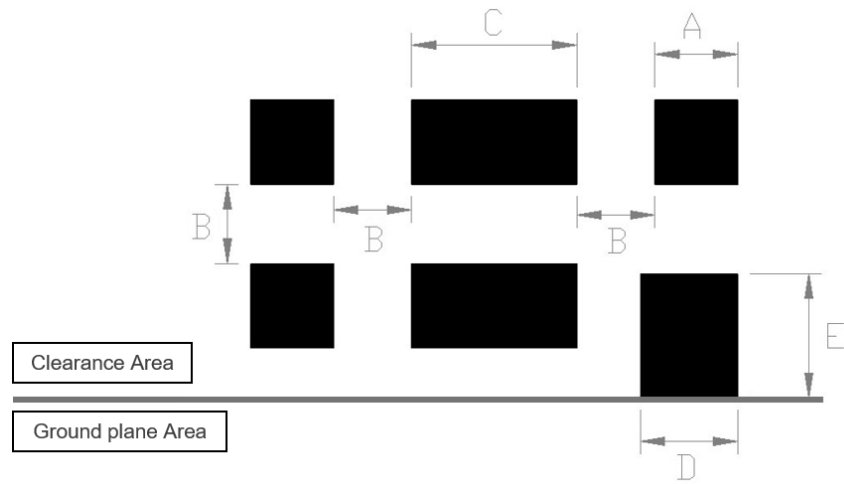

**Figure 9** – Footprint dimensions for the double booster.

For additional support in the integration process, please contact [support@ignion.io](mailto:support@ignion.io).