

ignion[™]

Your innovation.
Accelerated.

TRIO mXTEND[™]: MOBILE AND GNSS IN THE SAME PACKAGE AT THE SAME TIME

APPLICATION NOTE
TRIO mXTEND[™] (NN03-310)

TRIO mXTEND[™]: MOBILE AND GNSS IN THE SAME PACKAGE AT THE SAME TIME

- **Antenna Component:** TRIO mXTEND[™] NN03-310
- **Dimensions:** 30.0 mm x 3.0 mm x 1.0 mm
- **Frequency regions:** 824-960 MHz, 1710-2170 MHz, 1561 MHz, 1575 MHz & 1598-1606 MHz



The trend these days is that any wireless project offers connectivity at multiple communication standards, therefore more than one antenna should be used. We care about the usual **lack of space** and the **double cost** of integrating two different antennas into one device. Accordingly, the result is the challenge of reducing two antennas into one: **TRIO mXTEND[™]**, the antenna component that **enables GNSS and Mobile connectivity simultaneously through a single antenna package**.

Forget about having too many antenna choices, just select TRIO mXTEND[™]. This chip antenna is an off-the-shelf piece, no customization is needed and even better, it works in multiple frequency regions at the same time thanks to its **modular, multiband and multi-port** configuration.

The double functionality of this chip antenna component will save time, cost and could accelerate time to market to all those applications requiring this dual relation, as for example fleet management, automotive or IoT, the new generation of “connected things”.

TRIO mXTEND[™], the newest member of the Virtual Antenna[™] (antenna less) family, is presented in an **ultra slim, off the shelf component of only 1.0 mm height** and could be easily assembled into virtually any mobile or IoT device.

TABLE OF CONTENTS

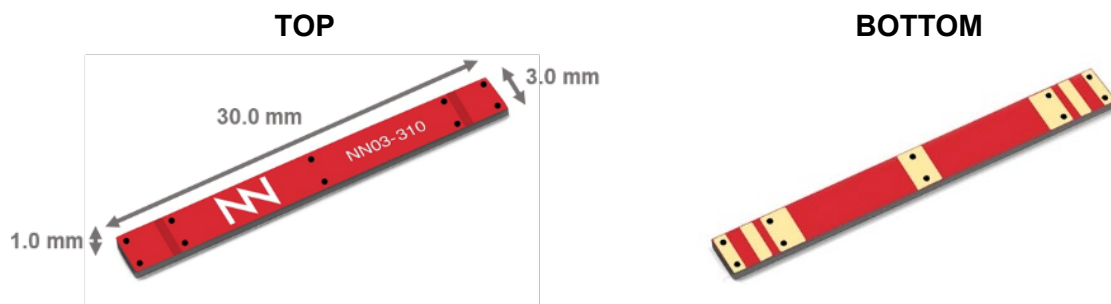
1. PRODUCT DESCRIPTION NN03-310	4
2. EVALUATION BOARD (824-960MHz, 1710-2170MHz and 1561MHz, 1575MHz, and 1598-1606MHz)	5
2.1. QUICK REFERENCE GUIDE	5
2.2. EVALUATION BOARD (824-960 MHz, 1710-2170 MHz and 1561 MHz, 1575 MHz, and 1598-1606 MHz)	6
2.3. MATCHING NETWORK	7
2.4. VSWR AND TOTAL EFFICIENCY	9
2.5. TRANSMISSION COEFFICIENT	10
2.6. RADIATION PATTERNS (824 – 960 MHz), GAIN AND EFFICIENCY	11
2.7. RADIATION PATTERNS (1710 – 2170 MHz), GAIN AND EFFICIENCY	12
2.8. RADIATION PATTERNS (1561 MHz, 1575 MHz, 1598 - 1606 MHz), GAIN AND EFFICIENCY	13
2.9. RECOMMENDED FOOTPRINT FOR THE SOLUTION	14

1. PRODUCT DESCRIPTION NN03-310

The TRIO mXTEND[™] chip antenna component has been specifically designed for providing the major level of flexibility to operate at any required frequency band inside any wireless device and enables the antenna to work in different frequency bands at the same time.

TRIO mXTEND[™] chip antenna component covers among many others, the frequency bands used for operating at the Global Navigation Satellite Systems, GPS, Galileo, GLONASS and BeiDou while it covers worldwide 2G, 3G and 4G.

It offers the flexibility to be tuned at the frequency regions of interest through the proper adjustment of the matching network. This feature provides an important benefit since removes the need of including different antenna parts inside the same wireless device for operating different communication standards, thus reducing considerably the integration complexity while saving costs. The results gathered herein presents how the matching network should be configured for operating the main mobile communication standards of 2G, 3G, 4G and GNSS bands.



Material: The TRIO mXTEND[™] chip antenna component is built on glass epoxy substrate.

APPLICATIONS

- Handsets
- Smartphones
- Tablets
- Tracking systems
- Navigation Devices
- Smart Meters (Gas, Electricity, Water...)
- Digital Cameras
- Wearables
- Sensors (Parking, Speed control, Optics...)
- IoT Devices
- GPS/GLONASS/BeiDou Modules

BENEFITS

- High efficiency
- Small size
- Cost-effective
- Easy-to-use (pick and place)
- Multiband behaviour (worldwide standards)
- Off-the-Shelf Standard Product (no customization is required)

2. EVALUATION BOARD (824-960MHz, 1710-2170MHz and 1561MHz, 1575MHz, and 1598-1606MHz)

2.1. QUICK REFERENCE GUIDE

Technical features	824 – 960 MHz	1710 – 2170 MHz
Average Efficiency	> 55 %	> 60 %
Peak Gain	1.9 dBi	1.9 dBi
VSWR	< 3:1	
Radiation Pattern	Omnidirectional	
Polarization	Linear	
Weight (approx.)	0.25 g	
Temperature	-40 to +125 °C	
Impedance	50 Ω	
Dimensions (L x W x H)	30.0 mm x 3.0 mm x 1.0 mm	

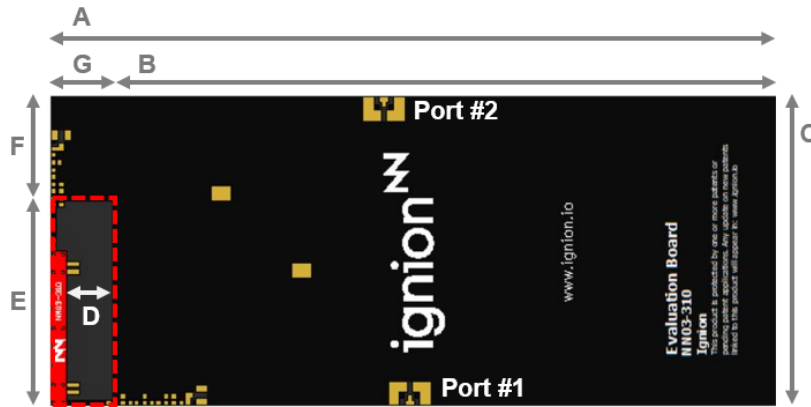
Table 1 – Technical features for the 2G/3G/4G bands. Measures from the Evaluation Board port #1. See Figure 1. Note that for obtaining comparable results, a ground plane length larger than 100 mm is recommended.

Technical features	1561 MHz	1575 MHz	1598 – 1606 MHz
Average Efficiency	> 40 %	> 40 %	> 40 %
Peak Gain	0.5 dBi	0.8 dBi	1.5 dBi
VSWR	< 3:1		
Radiation Pattern	Omnidirectional		
Polarization	Linear		
Weight (approx.)	0.25 g		
Temperature	-40 to +125 °C		
Impedance	50 Ω		
Dimensions (L x W x H)	30.0 mm x 3.0 mm x 1.0 mm		

Table 2 – Technical Features for the GNSS bands (BeiDou, GPS, Galileo, and GLONASS). Measures from the Evaluation Board port #2. See Figure 1.

2.2. EVALUATION BOARD (824-960 MHz, 1710-2170 MHz and 1561 MHz, 1575 MHz, and 1598-1606 MHz)

This Evaluation Board (part number: EB_NN03-310-M-GNSS) integrates one TRIO mXTEND™ chip antenna component to provide operation from 824 to 960 MHz, 1710 to 2170 MHz through port #1, and 1561 MHz, 1575 MHz, and 1598 to 1606 MHz through port #2. Two UFL cable connects each input/output port to SMA connectors.



Measure	mm
A	142
B	130
C	60
D	9
E	40
F	20
G	12

Tolerance: ±0.2 mm

Material: The Evaluation Board is built on FR4 substrate. Thickness is 1 mm.

D: Distance between the TRIO mXTEND™ chip antenna component and the ground plane.

Clearance Area: 40 mm x 12 mm (ExG)

Figure 1 – EB_NN03-310-M-GNSS. Evaluation Board for providing operation at 824 – 960MHz, 1710 – 2170MHz (port #1), and 1561MHz, 1575MHz, and 1598 – 1606MHz (port #2).

This product and its use are protected by at least one or more of the following [patents and patent applications](#) PAT. US 62/529032; and other domestic and international patents pending. Additional information about patents related to this product is available at www.ignion.io/virtual-antenna/.

2.3. MATCHING NETWORK

The specs of a Ignion standard product are measured in their Evaluation Board, which is an ideal case. In a real design, components nearby the antenna, LCD's, batteries, covers, connectors, etc. affect the antenna performance. This is the reason why it is highly recommended placing pads compatible with 0402 and 0603 SMD components for a matching network as close as possible to the feeding point. Do it in the ground plane area, not in the clearance area. This provides a degree of freedom to tune the TRIO mXTEND™ chip antenna component once the design is finished and considering all elements of the system (batteries, displays, covers, etc.).

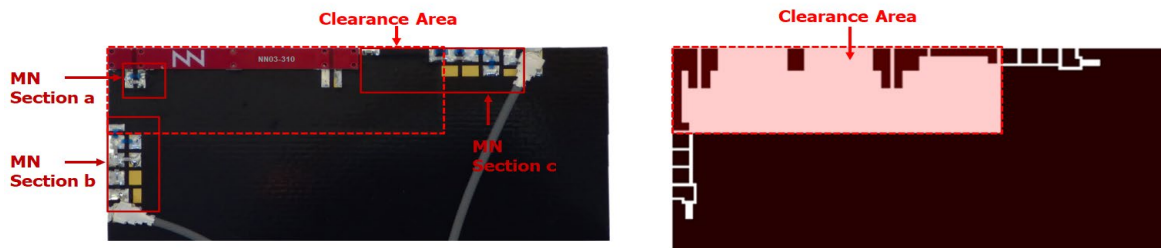


Figure 2 – Matching network distribution

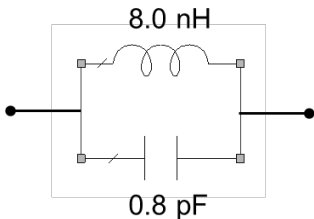
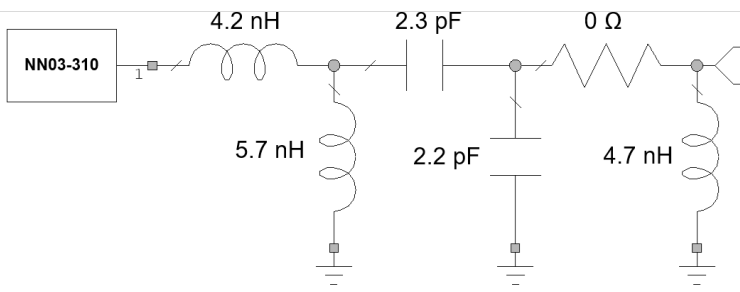
824 MHz – 960 MHz and 1710 MHz – 2170 MHz																
MN Section a		<table border="1"> <thead> <tr> <th>Value</th> <th>Part Number</th> </tr> </thead> <tbody> <tr> <td>8.0 nH</td> <td>LQW15AN8N0G80</td> </tr> <tr> <td>0.8 pF</td> <td>GJM1555C1HR80WB 01</td> </tr> </tbody> </table>	Value	Part Number	8.0 nH	LQW15AN8N0G80	0.8 pF	GJM1555C1HR80WB 01								
		Value	Part Number													
8.0 nH	LQW15AN8N0G80															
0.8 pF	GJM1555C1HR80WB 01															
MN Section b		<table border="1"> <thead> <tr> <th>Value</th> <th>Part Number</th> </tr> </thead> <tbody> <tr> <td>4.2 nH</td> <td>LQW15AN4N2G80</td> </tr> <tr> <td>5.7 nH</td> <td>LQW15AN5N7B80</td> </tr> <tr> <td>2.3 pF</td> <td>GJM1555C1H2R3WB 01</td> </tr> <tr> <td>2.2 pF</td> <td>GJM1555C1H2R2WB 01</td> </tr> <tr> <td>0 Ω</td> <td></td> </tr> <tr> <td>4.7 nH</td> <td>LQW15AN4N7G80</td> </tr> </tbody> </table>	Value	Part Number	4.2 nH	LQW15AN4N2G80	5.7 nH	LQW15AN5N7B80	2.3 pF	GJM1555C1H2R3WB 01	2.2 pF	GJM1555C1H2R2WB 01	0 Ω		4.7 nH	LQW15AN4N7G80
		Value	Part Number													
		4.2 nH	LQW15AN4N2G80													
		5.7 nH	LQW15AN5N7B80													
		2.3 pF	GJM1555C1H2R3WB 01													
		2.2 pF	GJM1555C1H2R2WB 01													
0 Ω																
4.7 nH	LQW15AN4N7G80															

Figure 3 – Matching network implemented in the Evaluation Board port #1 (Figure 1).

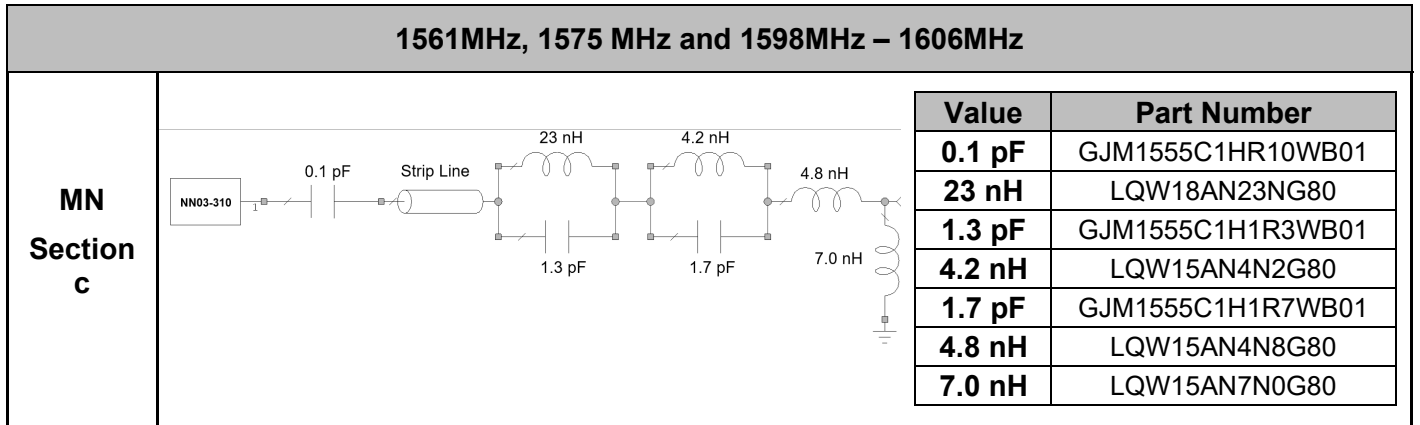


Figure 4 – Matching network implemented in the Evaluation Board port #2 (Figure 1).

Please notice that different devices with different ground planes and different components nearby the TRIO mXTEND™ chip antenna component may need a different matching network. To ensure optimal results, the use of high Q and tight tolerance components is highly recommended (Murata components). If you need assistance to design your matching network beyond this application note, please contact support@ignion.io, or try our free-of-charge¹ **NN Wireless Fast-Track** design service, you will get your chip antenna design including a custom matching network for your device in 24h¹. Other related to NN's range of R&D services is available at: <https://www.ignion.io/rdservices/>

¹ See terms and conditions for a free NN Wireless Fast-Track service in 24h at: <https://www.ignion.io/fast-track-project/>

2.4. VSWR AND TOTAL EFFICIENCY

VSWR (Voltage Standing Wave Ratio) and Total Efficiency versus Frequency (GHz).

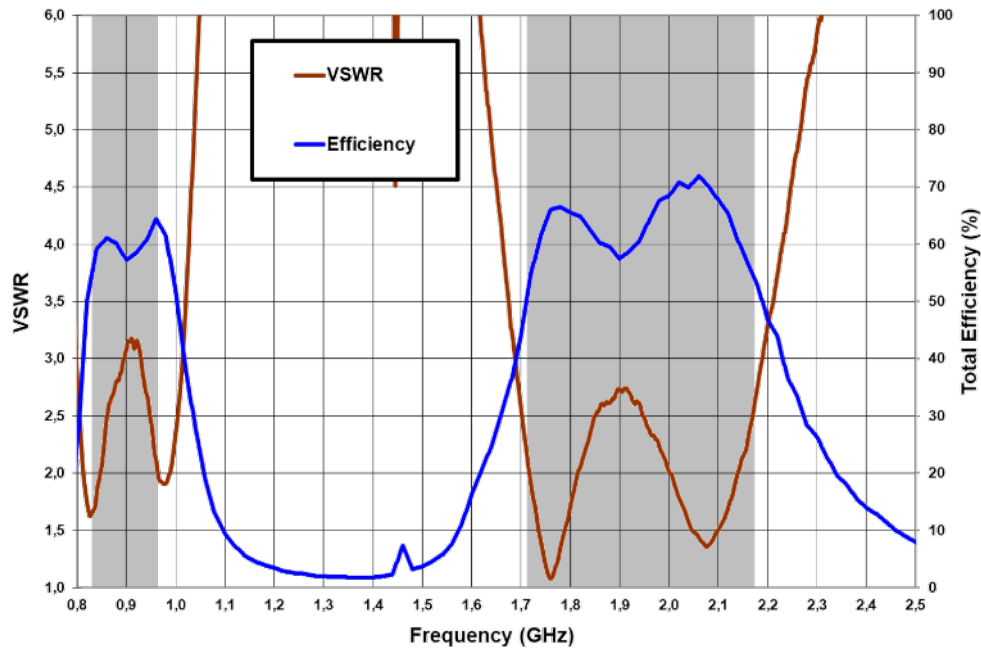


Figure 4 – VSWR and Total Efficiency for the 824 – 960 MHz frequency range and for the 1710 – 2170 MHz frequency range (from the Evaluation Board, port #1) (Figure 1).

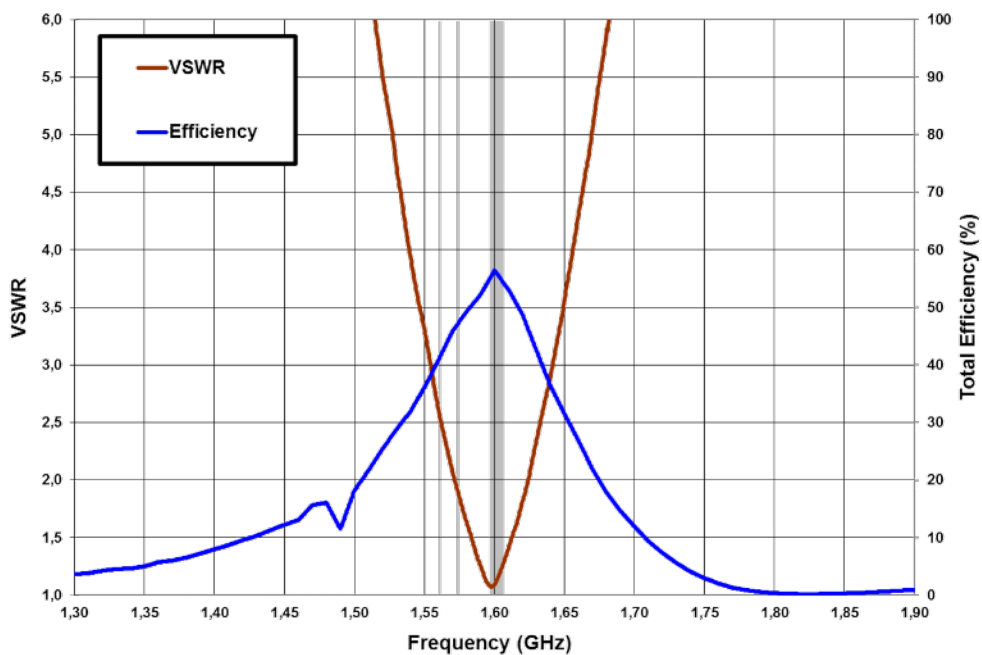


Figure 5 – VSWR and Total Efficiency for BeiDou E1 band (1561 MHz), GPS L1 band, Galileo E1 (1575 MHz), and GLONASS L1 band (1598 – 1606 MHz) (from the Evaluation Board, port #2) (Figure 1)

2.5. TRANSMISSION COEFFICIENT

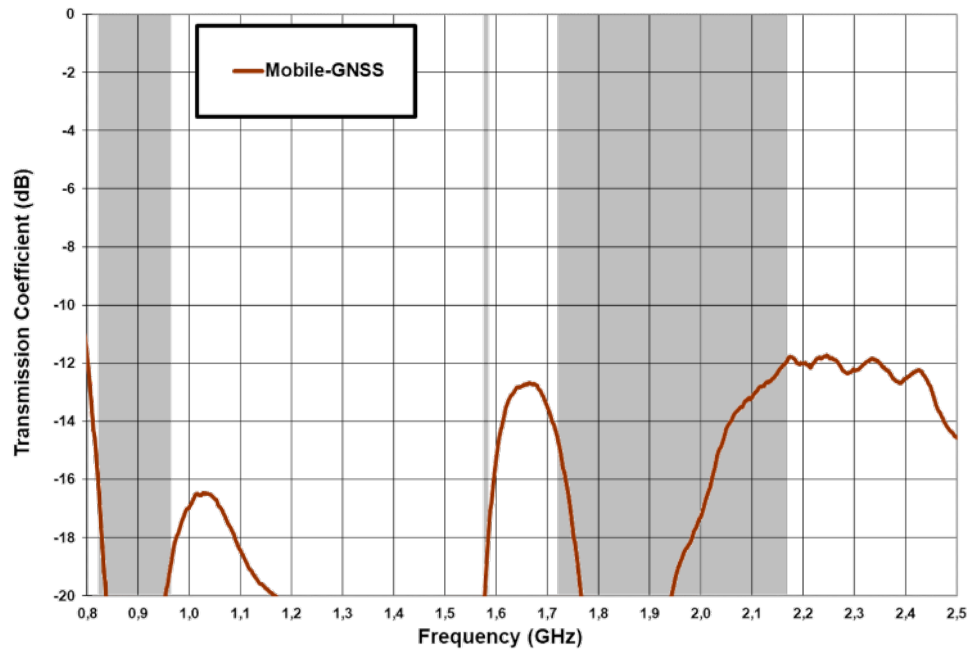
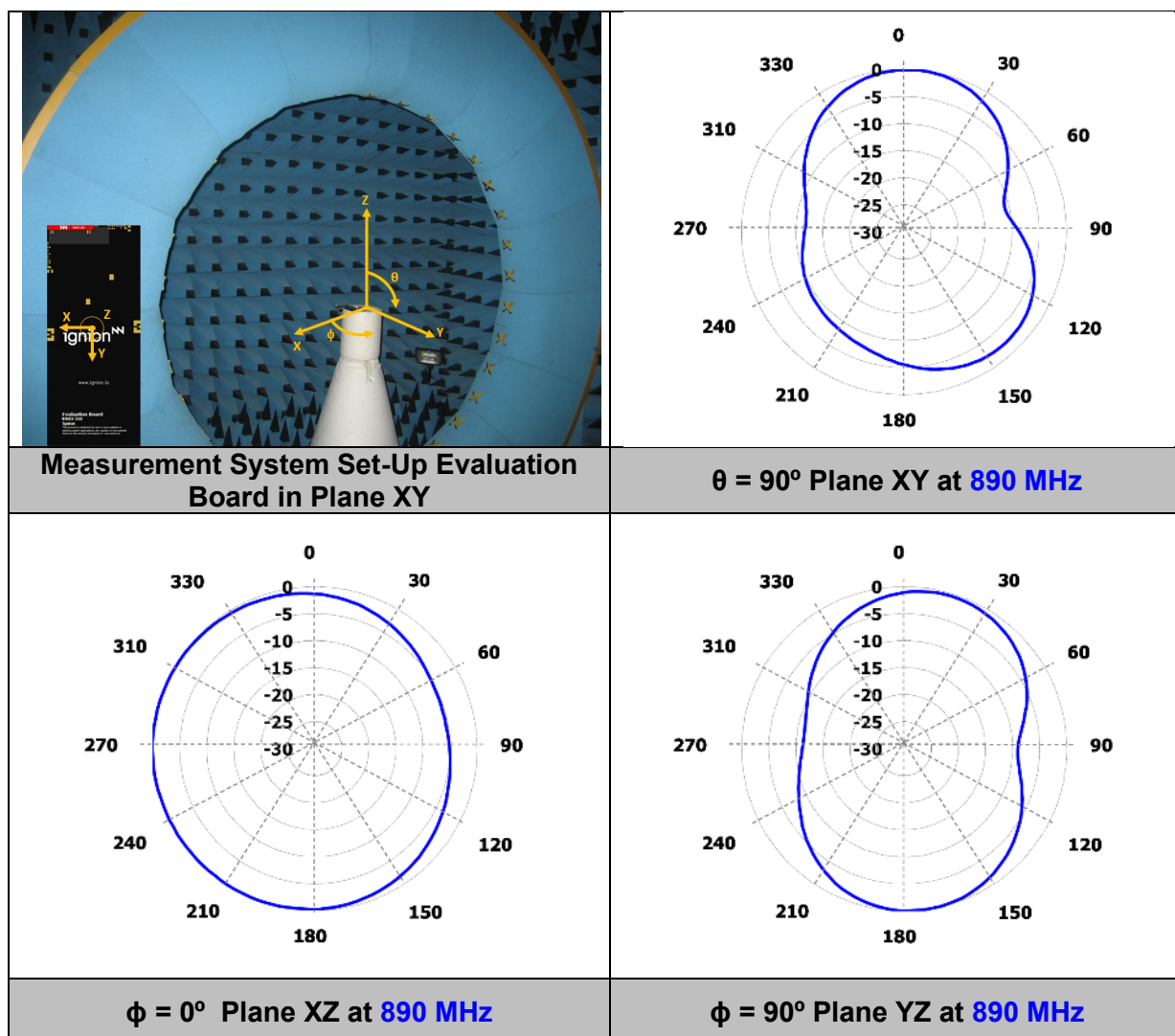


Figure 6 – Transmission coefficient between port #1 (824 – 960 MHz and 1710 – 2170 MHz) and port #2 (1561 – 1606 MHz) from the Evaluation Board (Figure 1)

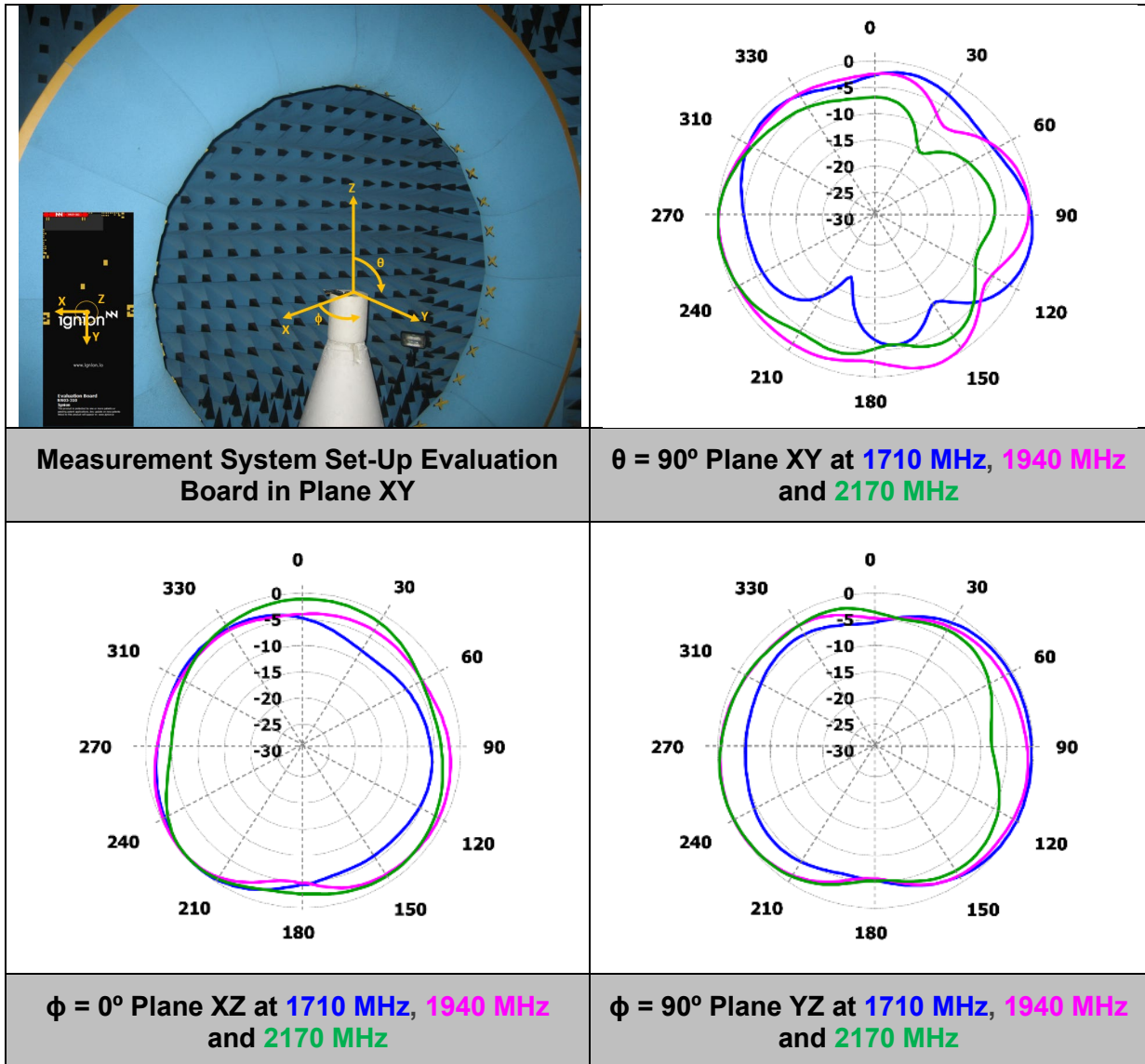
2.6. RADIATION PATTERNS (824 – 960 MHz), GAIN AND EFFICIENCY



Gain	Peak Gain	1.9 dBi
	Average Gain across the band	1.1 dBi
	Gain Range across the band (min, max)	0.2 \leftrightarrow 1.9 dBi
Efficiency	Peak Efficiency	64.5 %
	Average Efficiency across the band	59.4 %
	Efficiency Range across the band (min, max)	52.2 – 64.5 %

Table 3 - Antenna Gain and Total Efficiency from the Evaluation Board port #1 (Figure 1) within the 824 – 960 MHz frequency range. Measures made in the Satimo STARGATE 32 anechoic chamber.

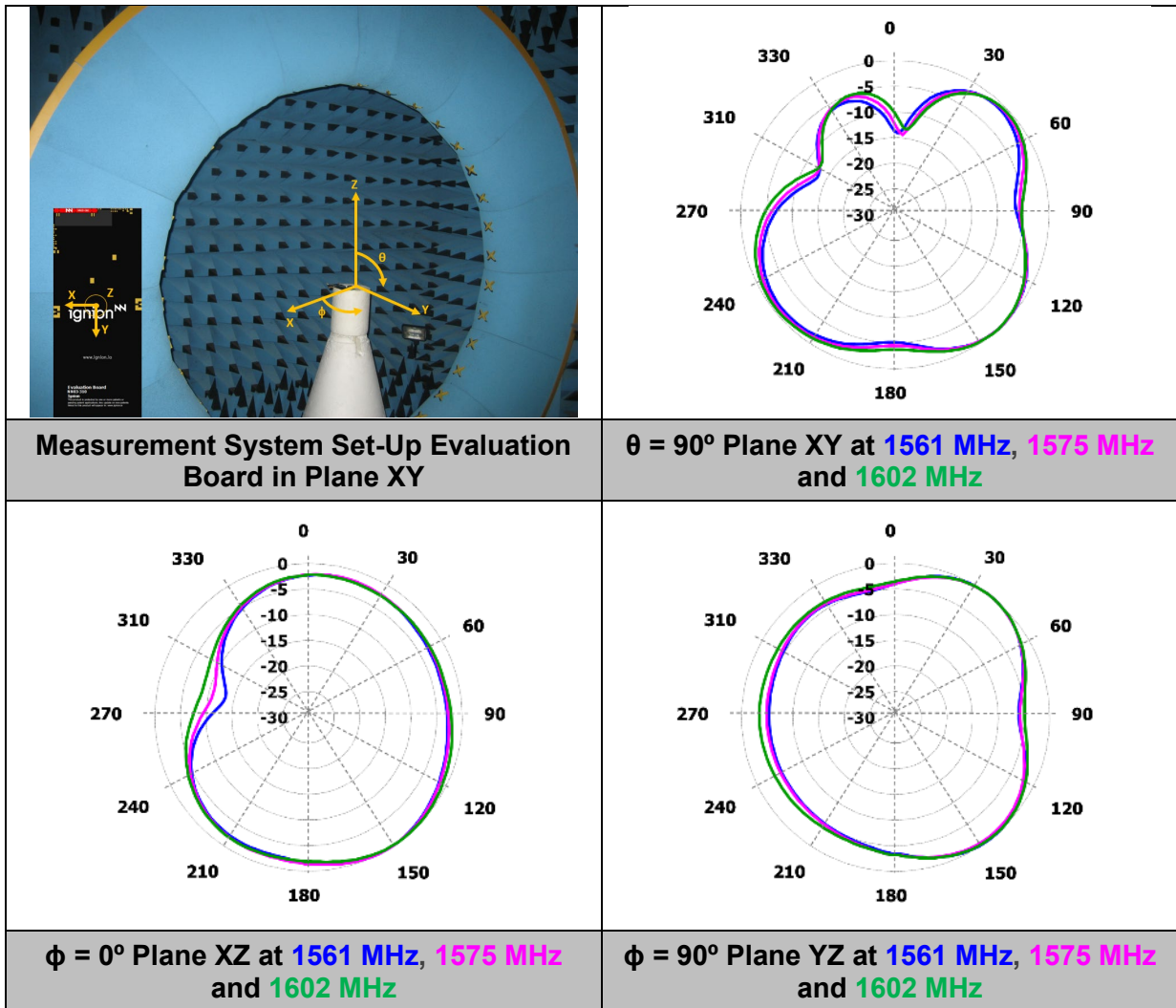
2.7. RADIATION PATTERNS (1710 – 2170 MHz), GAIN AND EFFICIENCY



Gain	Peak Gain	1.9 dBi
	Average Gain across the band	0.9 dBi
	Gain Range across the band (min, max)	-0.2 \leftrightarrow 1.9 dBi
Efficiency	Peak Efficiency	71.9 %
	Average Efficiency across the band	63.9 %
	Efficiency Range across the band (min, max)	49.7 – 71.9 %

Table 4 - Antenna Gain and Total Efficiency from the Evaluation Board port #1 (Figure 1) within the 1710 – 2170 MHz frequency range. Measures made in the Satimo STARGATE 32 anechoic chamber.

2.8. RADIATION PATTERNS (1561 MHz, 1575 MHz, 1598 - 1606 MHz), GAIN AND EFFICIENCY



BeiDou	Gain	0.5 dBi		
	Efficiency	41.4%		
GPS Galileo	Gain	0.8 dBi		
	Efficiency	47.6 %		
GLONASS	Gain	Peak Gain	1.5 dBi	
		Average Gain across the band	1.2 dBi	
		Gain Range across the band (min, max)	0.8 <--> 1.5 dBi	
	Efficiency	Peak Efficiency	56.4 %	
		Average Efficiency across the band	55.5 %	
		Efficiency Range across the band (min, max)	54.4 – 56.4 %	

Table 5 - Antenna Gain and Total Efficiency from the evaluation board port #2 (Figure 1) for BeiDou E1 (1561 MHz), GPS L1, Galileo E1 (1575 MHz), and GLONASS L1 (1598 – 1606 MHz) bands. Measures made in the Satimo STARGATE 32 anechoic chamber.

2.9. RECOMMENDED FOOTPRINT FOR THE SOLUTION

Assuming that the TRIO mXTEND™ chip antenna component NN03-310 is placed in the clearance area of the PCB, see below the recommended footprint dimensions, to provide operation from 824 to 960 MHz, 1710 to 2170 MHz through port #1, and 1561 MHz, 1575 MHz, and 1598 to 1606 MHz through port #2

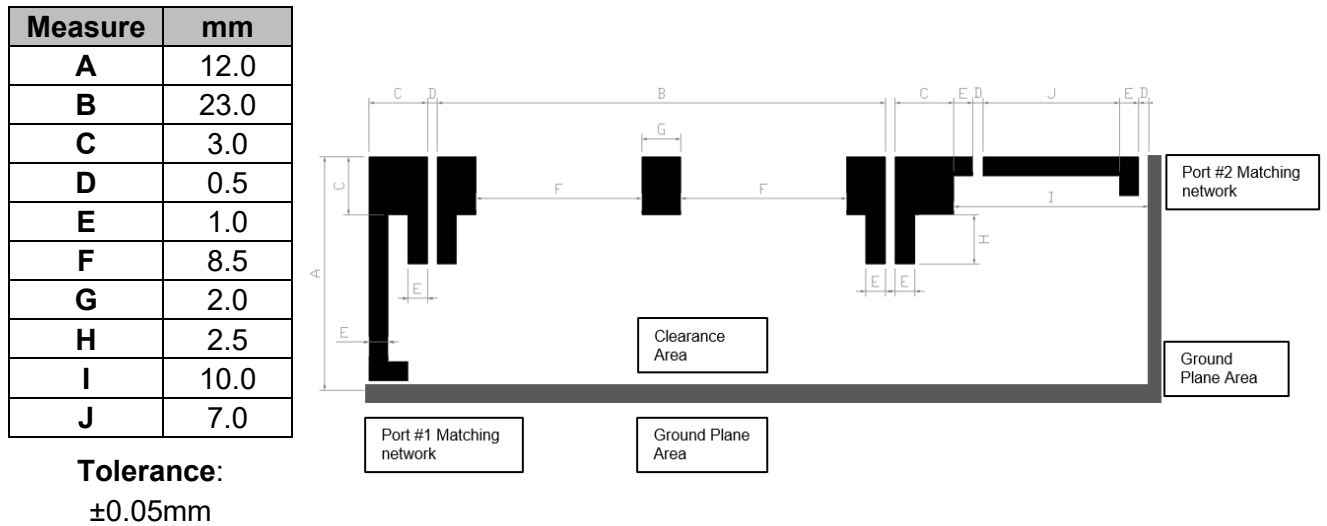


Figure 7 – Footprint dimensions for the single chip antenna component.

For additional support in the integration process, please contact support@ignion.io.

The TRIO mXTEND™ chip antenna component belongs to a new generation of antenna solutions based on the Virtual Antenna™ technology owned by Ignion. The technology is mainly focused on replacing conventional antenna solutions by miniature and standard components.

The TRIO mXTEND™ chip antenna component and other Ignion products based on its proprietary Virtual Antenna™ technology are protected by one or more of the following [Ignion patents](#).

All information contained within this document is property of Ignion and is subject to change without prior notice. Information is provided “as is” and without warranties. It is prohibited to copy or reproduce this information without prior approval.

Ignion is an ISO 9001:2015 certified company. All our antennas are lead-free and RoHS and REACH compliant.

Ignion products are protected by [Ignion patents](#).

All information contained within this document is property of Ignion and is subject to change without prior notice. Information is provided “as is” and without warranties. It is prohibited to copy or reproduce this information without prior approval.

Ignion is an ISO 9001:2015 certified company. All our antennas are lead-free and RoHS compliant.

ISO 9001: 2015 Certified

