

ignion[™]

Your innovation.
Accelerated.

TRIO mXTEND[™]: UP TO THREE RADIOS IN ONE TOP PERFORMING CHIP

USER MANUAL
TRIO mXTEND[™] (NN03-310)

TRIO mXTEND[™]

Up to three radios in one top performing chip



NN03-310

TRIO mXTEND[™] | Mobile | IoT Antenna

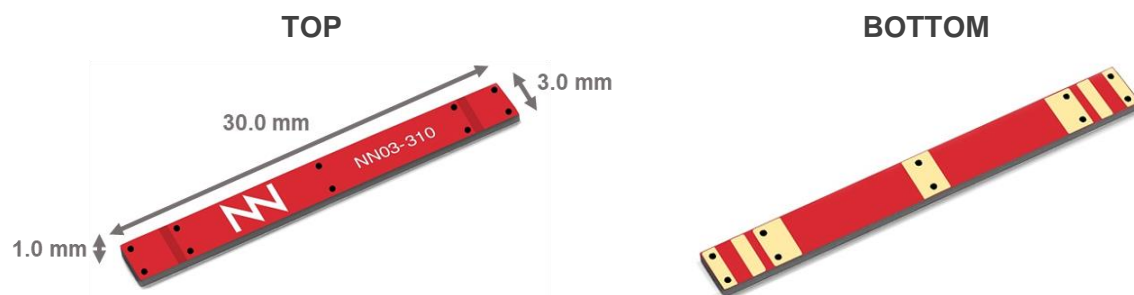
Operating range: 698 – 8000 MHz

Best for: 698 – 8000 MHz

Dimensions: 30.0 mm x 3.0 mm x 1.0 mm

What is TRIO mXTEND[™]?

TRIO mXTEND[™] is our top performing Virtual Antenna[™] product that covers the widest range of operating frequencies from 698 MHz up to 10.600 MHz in both cellular and unlicensed (ISM) IoT wireless devices. In addition, TRIO mXTEND[™] has three independent antenna components that flexibly enables embedding three different radios of choice, such as, 4G/5G, GNSS and Bluetooth/WiFi, into a single component. The TRIO mXTEND[™] has the smallest footprint in the market for its class and combined with its 1 mm slim form factor, it makes an ideal component for high-performance, small IoT tracking devices and sensors.



Material: The TRIO mXTEND[™] chip antenna component is built on glass epoxy substrate.

What is TRIO mXTEND[™] for?

TRIO mXTEND[™] is suitable for any mobile or IoT device requiring a top performance in the **Sub-GHz** frequency range. It works for global coverage cellular (**2G, 3G, 4G, 5G**) as well as unlicensed IoT devices (**LoRa, SigFox**) and can be used in both trackers and smart meters applications. The **3-independent** input/output radio ports makes TRIO mXTEND[™] an ideal compact solution for embedding **cellular/ISM, GNSS, Bluetooth** or **Wi-Fi** into a slim, compact **IoT** device and extending the operating frequency range of devices up to 10.600 MHz.

- Asset Trackers
- Smart Meters
- 5G Routers
- Mobile Reference Designs
- IoT Developer Kits
- Environmental Sensors
- Logistic Trackers
- Notebooks/Tablets
- Health sensors
- Animal Trackers
- Security sensors
- Point of Sales
- Vending Machines
- Smart City sensors




What differentiates TRIO mXTEND[™] from other chip antennas?

Like every other Virtual Antenna[™] product, TRIO mXTEND[™] is frequency neutral, meaning that its frequency response is not determined by the antenna component but designed by the electronics engineer. Virtual Antenna[™] technology enables packaging the desired multiband performance in the smallest ever form factors, which enables the whole mXTEND range of components becoming tiny off-the-shelf, surface-mount (SMD) electronic chips. That makes mXTEND components easy to be integrated in about any IoT device through a shorter and easier design cycle and a much more robust, reliable and costs effective manufacturing process.

<p>Off-the-shelf Ready to be delivered 'as is' with no need for customization.</p>	<p>Up to 10 times smaller A booster can be 5³mm³ providing the same connectivity.</p>	<p>Versatility A phone can be designed with several architectures yet still using the same component.</p>	<p>Scalability The 'heart' of the design can be reused across multiple device models.</p>
<hr style="border: 0; border-top: 1px solid red; margin: 10px 0;"/>			
<p>Modular Modules or standard building blocks can be re-used in the design of multiple devices.</p>	<p>Multiband A single antenna provides connectivity in 2G, 3G and 4G band.</p>	<p>Full performance The same performance in a much smaller, off-the-shelf and versatile component.</p>	<p>Pick & place No manual assembly is needed, only a conventional SMT machine.</p>

In addition, TRIO mXTEND[™] is the first Virtual Antenna[™] product featuring **Variant[™]** technology, which enables embedding **multiple antenna boosting elements into a single chip**. This provides a great **flexibility** in the design of a wireless IoT or mobile product, as a single antenna chip covers, through 3 independent radio ports/feeds, all radio needs for most of the IoT applications. That includes, for instance, Wide Area Network (WAM) applications (cellular but also ISM), but also GNSS, or Bluetooth/Wi-Fi/UWB, to name a few examples.

Click and select an application that fits your project:

<p>TRIO mXTEND[™] FOR CELLULAR IoT <i>Single-Port Configuration</i></p>		<p>(698 MHz – 2690 MHz)</p>
<p>TRIO mXTEND[™] FOR 5G <i>Two-Port Configuration</i></p>		<p>(698 MHz – 3800 MHz)</p>
<p>TRIO mXTEND[™] IoT TRACKER <i>Three-Port Configuration</i></p>		<p>(824 MHz – 2500 MHz)</p>

Click to view other useful TRIO mXTEND[™] guidelines:

[HOW TO EMBED A VIRTUAL ANTENNA](#)

[MECHANICAL SPECIFICATIONS](#)

[ASSEMBLY AND MANUFACTURING](#)

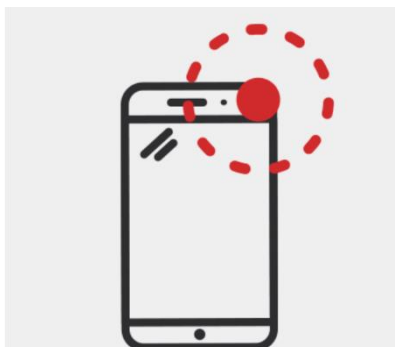
[PACKAGING](#)

Chapter Index

1. HOW TO EMBED A VIRTUAL ANTENNA	7
2. TRIO mXTEND[™] FOR IOT	9
3. TRIO mXTEND[™] FOR 5G	15
4. TRIO mXTEND[™] IOT TRACKER	21
5. MECHANICAL SPECIFICATIONS	32
6. ASSEMBLY AND MANUFACTURING	34
7. PACKAGING	36
8. PRODUCT CHANGE NOTIFICATION	37

How to embed a Virtual Antenna

Design with Virtual Antenna in 1-2-3



STEP 1: Place the antenna component

1. Select one corner of your PCB
2. Ensure your ground plane meets the TRIO mXTEND™ clearance area restrictions.
3. Respect a keep out space around the booster.
Keep at least 5mm distance from metallic objects

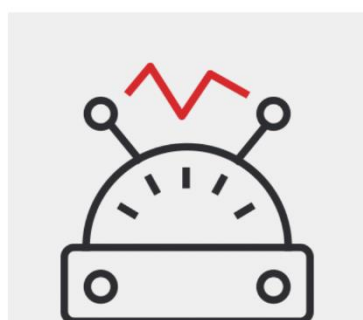
Look [here](#) for an example on placing the TRIO mXTEND™

STEP 2: Design your matching network

1. Through a combination of inductors & capacitors obtain 50 Ohms of antenna impedance to optimize the transfer of energy to your antenna
2. It is critical to fine-tune your MN throughout the entirety the design process of achieve your desired frequency response



Look [here](#) for an example of a matching network we found in an TRIO mXTEND™ application via simulation



STEP 3: Test your device

1. Perform a field test in which your antenna is placed in its final housing. Fine-tune the MN if needed.
2. Use a network analyzer to adjust mismatch
3. Test the antennas efficiency with an anechoic chamber

Look [here](#) for testing we did on our Evaluation Board, with the TRIO mXTEND™ integrated in our Anechoic Chamber

<https://www.ignion.io/tutorials>

Scan QR code to
be taken to our
videos highlighting
these three easy
steps





Need further help? Easy start with NN Wireless Fast Track

Do you need more help with your antenna for your device?

Use our **NN Wireless Fast Track service** and get your ready-to-test antenna design especially simulated for your platform **free of charge**¹, and in **24 hours**.

1. Fill out the form, submit it and receive a confirmation email.
2. Reply to the email. If you wish, attach any relevant design file.
3. Get your design in 24h.

<https://www.ignion.io/fast-track-project/>



Scan QR code
to be taken to
our Wireless
Fast Track
page

TRIO mXTEND[™] FOR IoT

In this application both the 698-960 MHz and 1710-2690 MHz frequency ranges are covered using the TRIO mXTEND[™] in single-port configuration. Using one of our Evaluation Boards, an example of a common TRIO mXTEND[™] placement is seen. Finally, two matching networks are selected, allowing us to test, obtain, and analyze the VSWR, total efficiency, gain and radiation patterns.

QUICK REFERENCE GUIDE

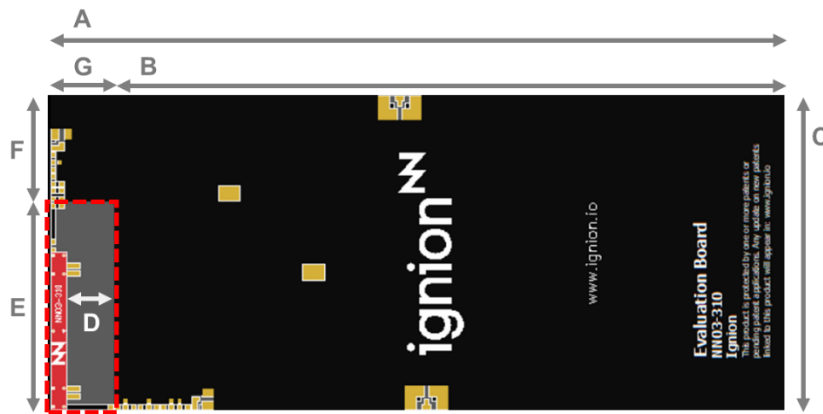
Technical features	698 – 960 MHz	1710 – 2690 MHz
Average Efficiency	> 55 %	> 65 %
Peak Gain	1.1 dBi	2.4 dBi
VSWR	< 3:1	
Radiation Pattern	Omnidirectional	
Polarization	Linear	
Weight (approx.)	0.25 g	
Temperature	-40 to +125 °C	
Impedance	50 Ω	
Dimensions (L x W x H)	30.0 mm x 3.0 mm x 1.0 mm	

Table 1 – Technical features. Measures from the Evaluation Board. See **Figure 1** – EB_NN03-310-M. Evaluation Board for **providing operation in 2 frequency ranges, 698 – 960MHz and 1710 – 2690MHz**.. Note that for obtaining comparable results, a ground plane length larger than 100 mm is recommended.

ELECTRICAL PERFORMANCE

EVALUATION BOARD

This Evaluation Board (part number: EB_NN03-310-M) integrates one TRIO mXTEND™ chip antenna component to provide operation in two frequency regions, from 698 MHz to 960 MHz and from 1710 MHz to 2690 MHz. A UFL cable connects this single input/output port to the SMA connector.



Measure	mm
A	142
B	130
C	60
D	9
E	40
F	20
G	12

Tolerance: ±0.2 mm

D: Distance between the TRIO mXTEND™ chip antenna component and the ground plane.

Figure 1 – EB_NN03-310-M. Evaluation Board for providing operation in 2 frequency ranges, 698 – 960MHz and 1710 – 2690MHz.

Material: The Evaluation Boards are built on FR4 substrate. Thickness is 1 mm.

Clearance Area: 40 mm x 12 mm (ExG)

This product and its use are protected by at least one or more of the following [patents and patent applications](#) PAT. US 62/529032; and other domestic and international patents pending. Additional information about patents related to this product is available at www.ignion.io/virtual-antenna/.

MATCHING NETWORK

The specs of a Ignion standard product are measured in their Evaluation Board, which is an ideal case. In a real design, components nearby the antenna, LCD's, batteries, covers, connectors, etc. affect the antenna performance. This is the reason why it is highly recommended placing pads compatible with 0402 and 0603 SMD components for a matching network as close as possible to the feeding point. Do it in the ground plane area, not in the clearance area. This provides a degree of freedom to tune the TRIO mXTEND™ chip antenna component once the design is finished and considering all elements of the system (batteries, displays, covers, etc.).

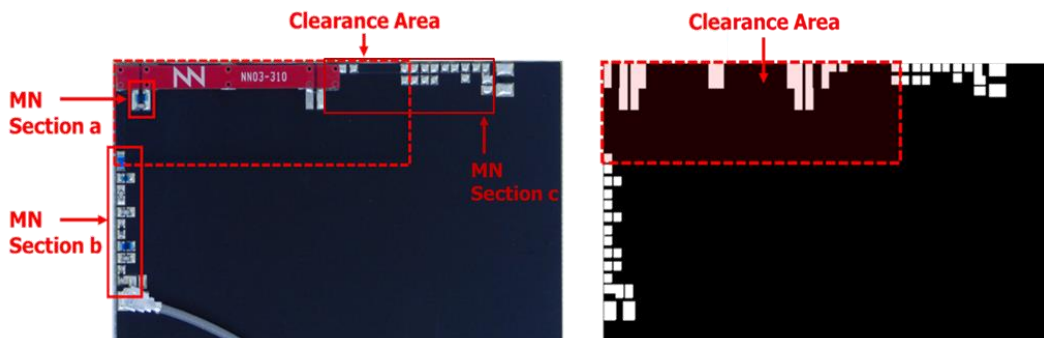


Figure 2 – Matching network distribution

Please notice that different devices with different ground planes and different components nearby the TRIO mXTEND™ chip antenna component may need a different matching network. To ensure optimal results, the use of high Q and tight tolerance components is highly recommended (Murata components).

698 MHz – 960 MHz and 1710 MHz – 2690 MHz															
MN Section a	<div style="display: flex; align-items: center; justify-content: center;"> <table border="1" style="margin-left: 20px;"> <thead> <tr> <th>Value</th> <th>Part Number</th> </tr> </thead> <tbody> <tr> <td>12 nH</td> <td>LQW18AN12NG10</td> </tr> <tr> <td>0.5 pF</td> <td>GJM1555C1HR50WB01</td> </tr> </tbody> </table> </div>	Value	Part Number	12 nH	LQW18AN12NG10	0.5 pF	GJM1555C1HR50WB01								
Value	Part Number														
12 nH	LQW18AN12NG10														
0.5 pF	GJM1555C1HR50WB01														
MN Section b	<div style="display: flex; align-items: center; justify-content: center;"> <table border="1" style="margin-left: 20px;"> <thead> <tr> <th>Value</th> <th>Part Number</th> </tr> </thead> <tbody> <tr> <td>2.4 nH</td> <td>LQW18AN2N4C80</td> </tr> <tr> <td>9.0 nH</td> <td>LQW15AN9N0G80</td> </tr> <tr> <td>2.1 pF</td> <td>GJM1555C1H2R1WB01</td> </tr> <tr> <td>0.7 pF</td> <td>GJM1555C1HR70WB01</td> </tr> <tr> <td>9.1 nH</td> <td>LQW18AN9N1G80</td> </tr> <tr> <td>0.4 pF</td> <td>GJM1555C1HR40WB01</td> </tr> </tbody> </table> </div>	Value	Part Number	2.4 nH	LQW18AN2N4C80	9.0 nH	LQW15AN9N0G80	2.1 pF	GJM1555C1H2R1WB01	0.7 pF	GJM1555C1HR70WB01	9.1 nH	LQW18AN9N1G80	0.4 pF	GJM1555C1HR40WB01
Value	Part Number														
2.4 nH	LQW18AN2N4C80														
9.0 nH	LQW15AN9N0G80														
2.1 pF	GJM1555C1H2R1WB01														
0.7 pF	GJM1555C1HR70WB01														
9.1 nH	LQW18AN9N1G80														
0.4 pF	GJM1555C1HR40WB01														

Figure 3 – Matching network implemented in the Evaluation Board 1 port (Figure 1).

This matching network applies to this Evaluation Board. Other configurations would require a matching network adjustment. If you need assistance to design your matching network beyond this application note, please contact support@ignion.io, or try our free-of-charge¹ **NN Wireless Fast-Track** design service, you will get your chip antenna design including a custom matching network for your device in 24h¹. Other related to NN's range of R&D services is available at: <https://www.ignion.io/rdservices/>

VSWR AND TOTAL EFFICIENCY

VSWR (Voltage Standing Wave Ratio) and Total Efficiency versus Frequency (GHz).

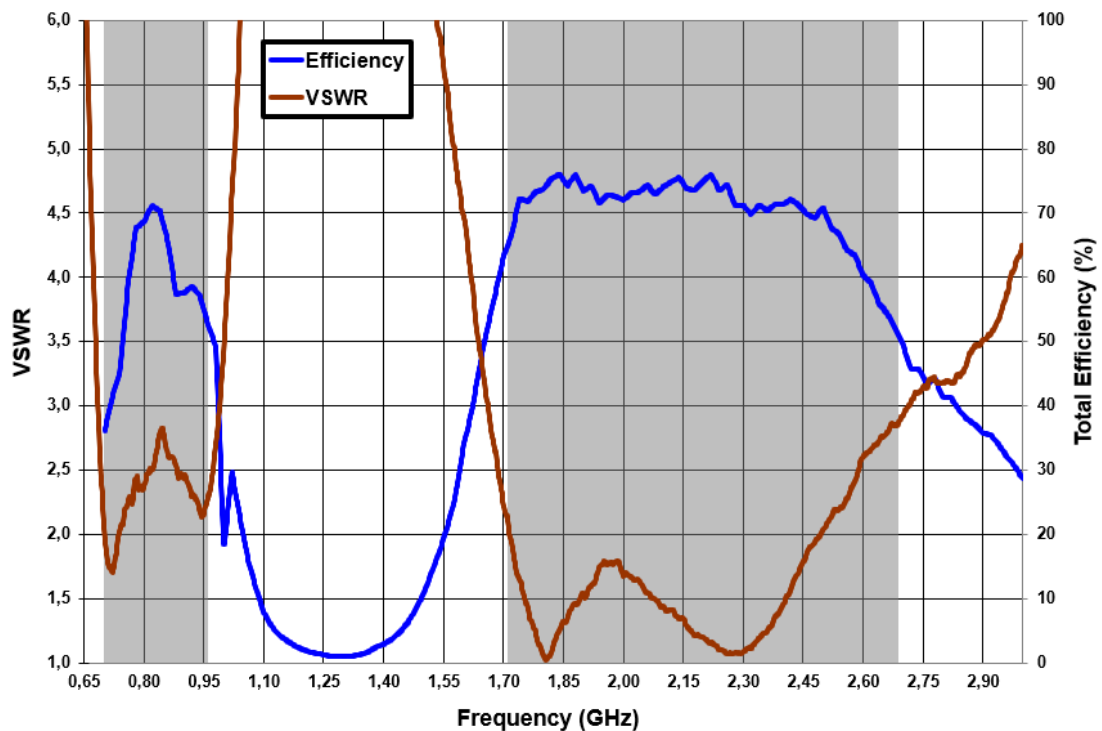
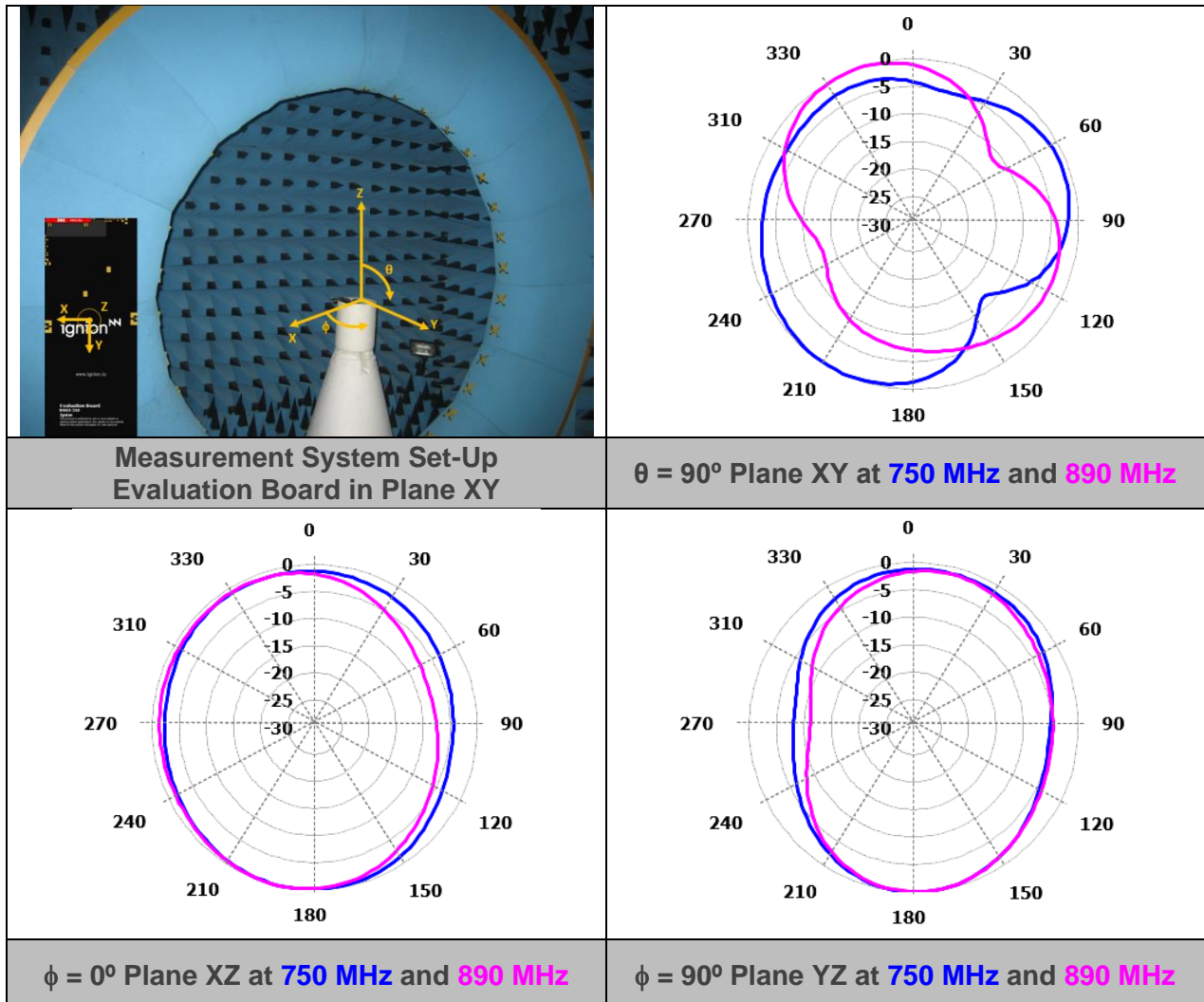


Figure 4 – VSWR and Total Efficiency for the 698 – 960 MHz frequency range and for the 1710 – 2690 MHz frequency range (from the Evaluation Board) (**Figure 1**).

¹ See terms and conditions for a free NN Wireless Fast-Track service in 24h at: <https://www.ignion.io/fast-track-project/>

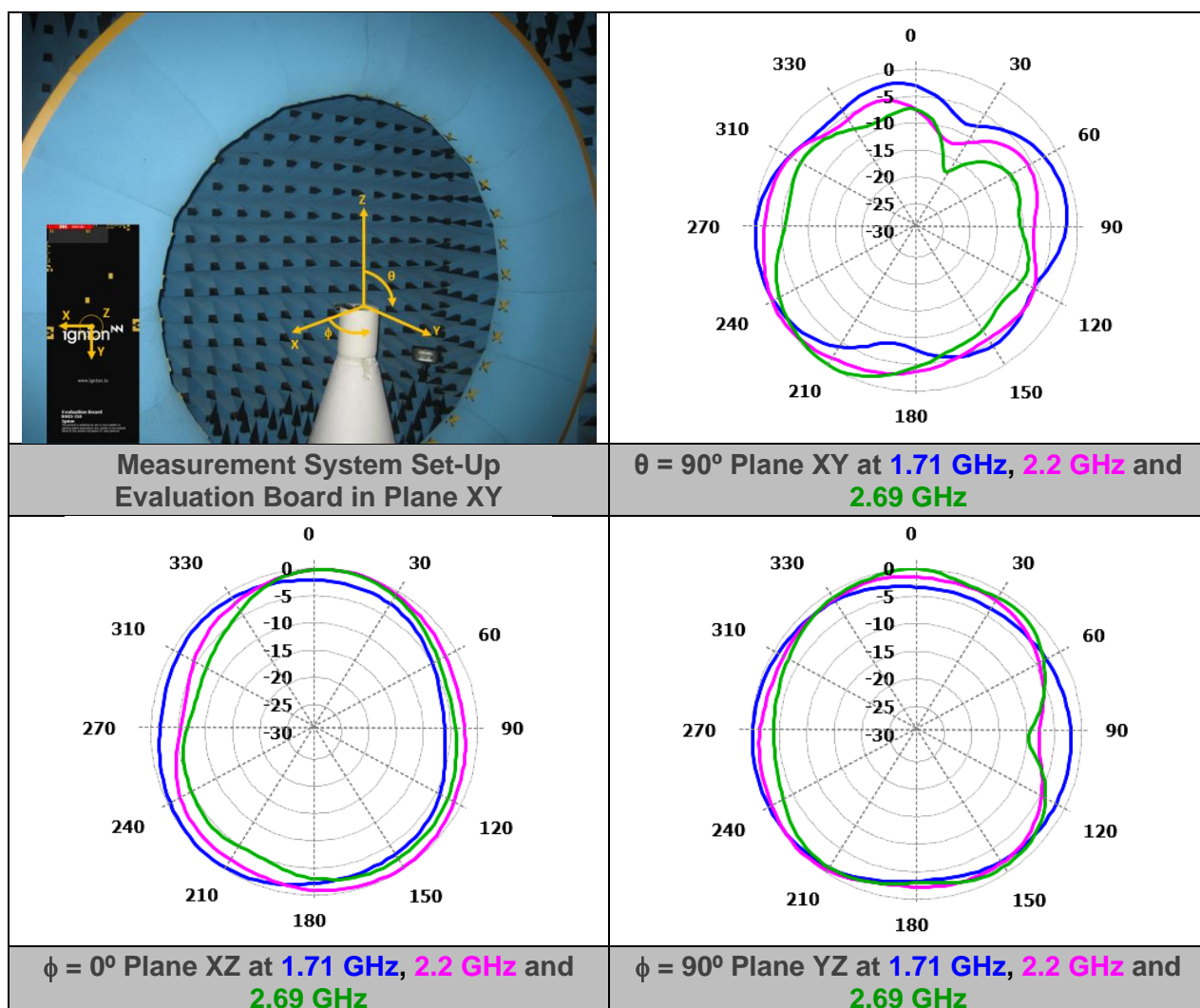
RADIATION PATTERNS (698-960 MHz), GAIN AND EFFICIENCY



Gain	Peak Gain	1.1 dBi
	Average Gain across the band	0.5 dBi
	Gain Range across the band (min, max)	-0.7 ↔ 1.1 dBi
Efficiency	Peak Efficiency	71.1 %
	Average Efficiency across the band	58.8 %
	Efficiency Range across the band (min, max)	36.1 – 52.5 %

Table 2 – Antenna Gain and Total Efficiency from the Evaluation Board (**Figure 1**) within the 698 – 960 MHz frequency range. Measures made in the Satimo STARGATE 32 anechoic chamber.

RADIATION PATTERNS (1710-2690 MHz), GAIN AND EFFICIENCY



Gain	Peak Gain	2.4 dBi
	Average Gain across the band	1.8 dBi
	Gain Range across the band (min, max)	0.3 \leftrightarrow 2.4 dBi
Efficiency	Peak Efficiency	76.0 %
	Average Efficiency across the band	70.4 %
	Efficiency Range across the band (min, max)	64.7 – 50.8 %

Table 3 – Antenna Gain and Total Efficiency for the Evaluation Board (Figure 1) within the 1710 – 2690 MHz frequency range. Measures made in the Satimo STARGATE 32 anechoic chamber.

TRIO mXTEND[™] for 5G

In this application, a design for **3G**, **4G** and **5G** in three different frequency regions: 698-960 MHz, 1710-2690 MHz and 3400-3800 MHz will be analyzed. A two-port configuration will be utilized, and three matching networks selected, allowing us to test, obtain, and analyze the VSWR, total efficiency, transmission coefficient, radiation patterns and arrive to a recommended footprint for this solution.

QUICK REFERENCE GUIDE

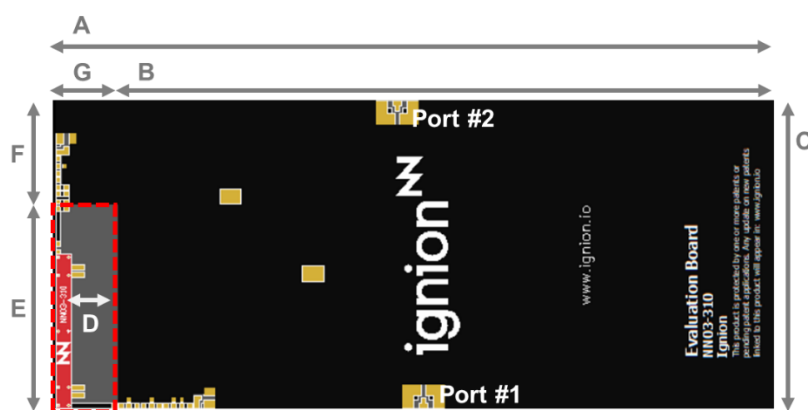
Technical features	698 – 960 MHz	1710 – 2690 MHz	3400 – 3800 MHz
Average Efficiency	> 50 %	> 60 %	> 65 %
Peak Gain	1.5 dBi	2.7 dBi	3.8 dBi
VSWR	< 3:1		< 2:1
Radiation Pattern	Omnidirectional		
Polarization	Linear		
Weight (approx.)	0.25 g		
Temperature	-40 to +125 °C		
Impedance	50 Ω		
Dimensions (L x W x H)	30.0 mm x 3.0 mm x 1.0 mm		

Table 4 – Technical features. Measures from the Evaluation Board. See **Figure 5**. Note that for obtaining comparable results, a ground plane length larger than 100 mm is recommended.

ELECTRICAL PERFORMANCE

EVALUATION BOARD

This Evaluation Board (part number: EB_NN03-310-M-5G) integrates one TRIO mXTEND™ chip antenna component to provide operation from 698 to 960 MHz, 1710 to 2690 MHz at port #1, and 3400 to 3800 MHz at port #2. Two UFL cable connects each input/output port to SMA connectors.



Measure	mm
A	142
B	130
C	60
D	9
E	40
F	20
G	12

Tolerance: ±0.2 mm

Material: The Evaluation Boards are built on FR4 substrate. Thickness is 1 mm.

D: Distance between the TRIO mXTEND™ chip antenna component and the ground plane.

Clearance Area: 40 mm x 12 mm (ExG)

Figure 5 – EB_NN03-310-M-5G. Evaluation Board for providing operation at 698 – 960MHz (Port #1), 1710 – 2690MHz and 3400 – 3800MHz (Port #2).

This product and its use are protected by at least one or more of the following [patents and patent applications](#) PAT. US 62/529032; and other domestic and international patents pending. Additional information about patents related to this product is available at www.ignion.io/virtual-antenna/.

MATCHING NETWORK

The specs of a Ignion standard product are measured in their Evaluation Board, which is an ideal case. In a real design, components nearby the antenna, LCD's, batteries, covers, connectors, etc. affect the antenna performance. This is the reason why it is highly recommended placing pads compatible with 0402 and 0603 SMD components for a matching network as close as possible to the feeding point. Do it in the ground plane area, not in the clearance area. This provides a degree of freedom to tune the TRIO mXTEND™ chip antenna component once the design is finished and taking into account all elements of the system (batteries, displays, covers, etc.).

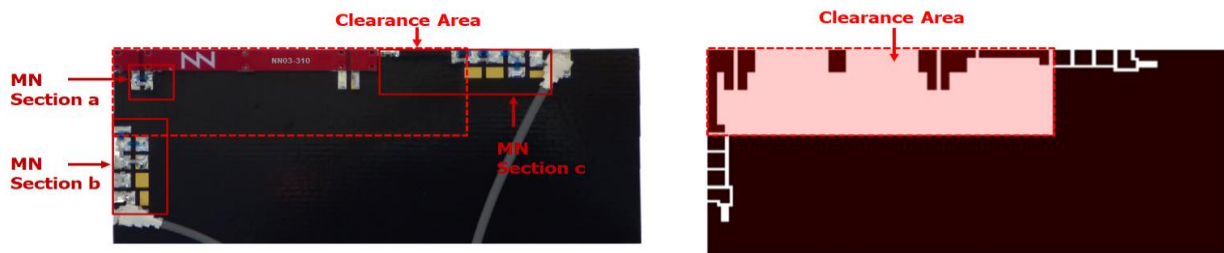


Figure 6 – Matching network distribution

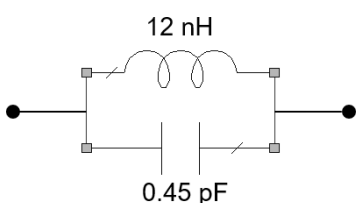
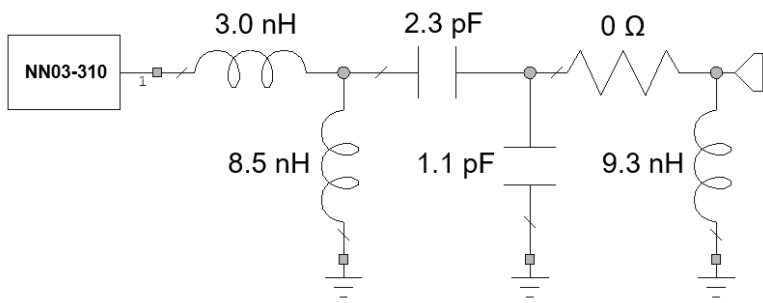
698 MHz – 960 MHz and 1710 MHz – 2690 MHz															
MN Section a	<div style="display: flex; align-items: center;">  <table border="1" style="margin-left: 20px;"> <thead> <tr> <th>Value</th> <th>Part Number</th> </tr> </thead> <tbody> <tr> <td>12 nH</td> <td>LQW18AN12NG00</td> </tr> <tr> <td>0.45 pF</td> <td>GJM1555C1HR45WB01</td> </tr> </tbody> </table> </div>	Value	Part Number	12 nH	LQW18AN12NG00	0.45 pF	GJM1555C1HR45WB01								
Value	Part Number														
12 nH	LQW18AN12NG00														
0.45 pF	GJM1555C1HR45WB01														
MN Section b	<div style="display: flex; align-items: center;">  <table border="1" style="margin-left: 20px;"> <thead> <tr> <th>Value</th> <th>Part Number</th> </tr> </thead> <tbody> <tr> <td>3.0 nH</td> <td>LQW15AN3N0G80</td> </tr> <tr> <td>8.5 nH</td> <td>LQW15AN8N5G80</td> </tr> <tr> <td>2.3 pF</td> <td>GJM1555C1H2R3WB01</td> </tr> <tr> <td>1.1 pF</td> <td>GJM1555C1H1R1WB01</td> </tr> <tr> <td>0 Ω</td> <td>-</td> </tr> <tr> <td>9.3 nH</td> <td>LQW15AN9N3G80</td> </tr> </tbody> </table> </div>	Value	Part Number	3.0 nH	LQW15AN3N0G80	8.5 nH	LQW15AN8N5G80	2.3 pF	GJM1555C1H2R3WB01	1.1 pF	GJM1555C1H1R1WB01	0 Ω	-	9.3 nH	LQW15AN9N3G80
Value	Part Number														
3.0 nH	LQW15AN3N0G80														
8.5 nH	LQW15AN8N5G80														
2.3 pF	GJM1555C1H2R3WB01														
1.1 pF	GJM1555C1H1R1WB01														
0 Ω	-														
9.3 nH	LQW15AN9N3G80														

Figure 7 – Matching network implemented in the Evaluation Board port #1 (Figure 5).

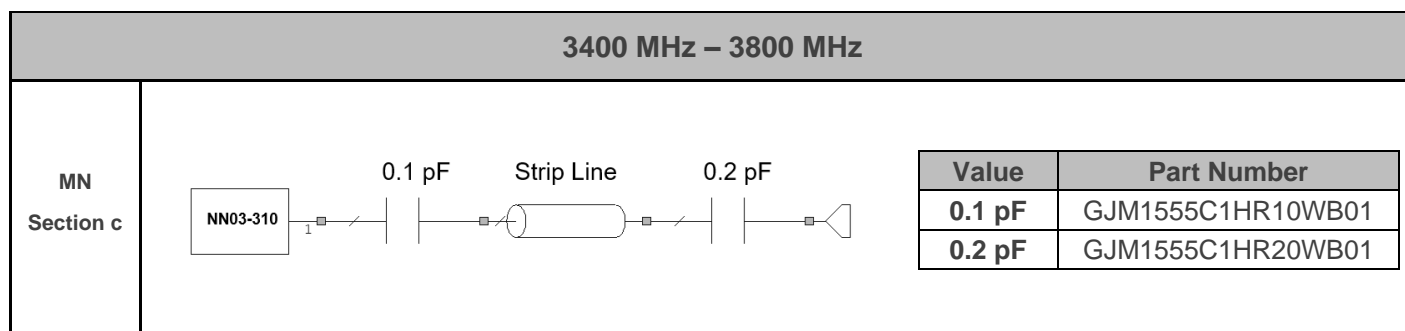


Figure 8 – Matching network implemented in the Evaluation Board port #2 (Figure 5).

Please notice that different devices with different ground planes and different components nearby the TRIO mXTEND[™] chip antenna component may need a different matching network. To ensure optimal results, the use of high Q and tight tolerance components is highly recommended (Murata components). If you need assistance to design your matching network beyond this application note, please contact support@ignion.io, or try our free-of-charge¹ **NN Wireless Fast-Track** design service, you will get your chip antenna design including a custom matching network for your device in 24h². Other related to NN's range of R&D services is available at: <https://www.ignion.io/rdservices/>

² See terms and conditions for a free NN Wireless Fast-Track service in 24h at: <https://www.ignion.io/fast-track-project/>

VSWR AND TOTAL EFFICIENCY

VSWR (Voltage Standing Wave Ratio) and Total Efficiency versus Frequency (GHz).

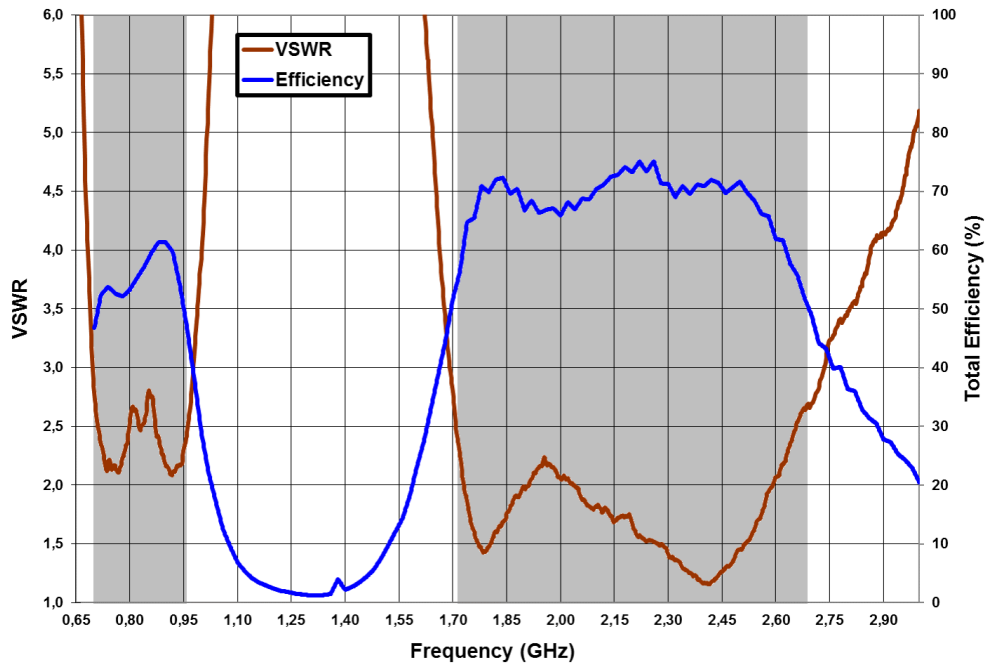


Figure 9 – VSWR and Total Efficiency for the 698 – 960 MHz frequency range and for the 1710 – 2690 MHz frequency range (from the Evaluation Board, port #1 (Figure 5)).

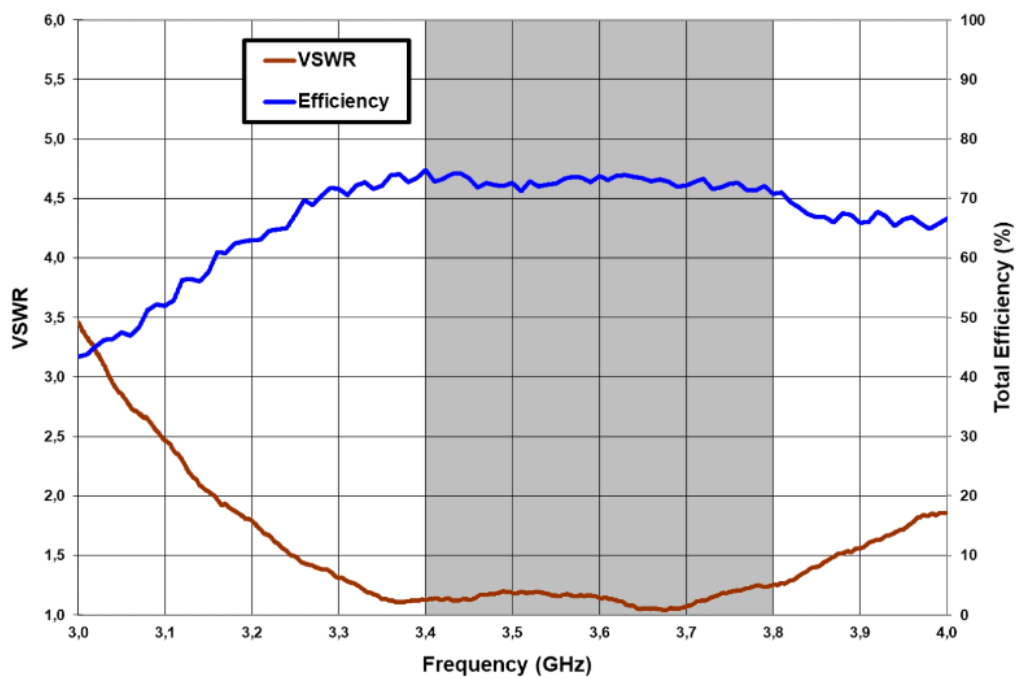


Figure 10 – VSWR and Total Efficiency for the 3400 – 3800 MHz frequency range (from the Evaluation Board, port #2 (Figure 5)).

TRANSMISSION COEFFICIENT

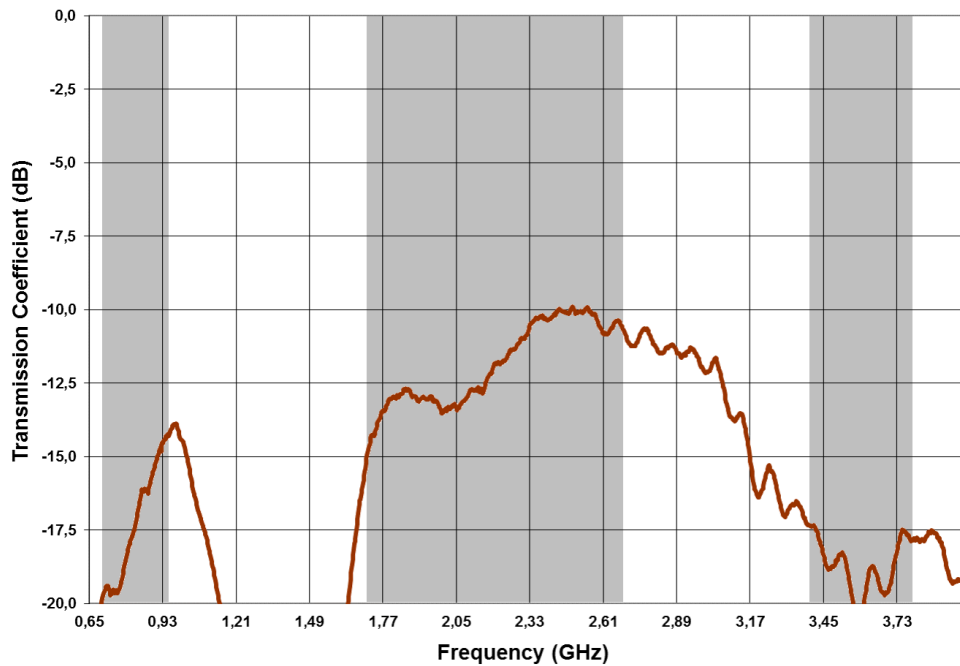


Figure 11– Transmission coefficient for the 698-960 MHz range, for 1710 – 2690 MHz range and for the 3400 – 3800 MHz range (from the Evaluation Board (Figure 5)).

RECOMMENDED FOOTPRINT FOR THE SOLUTION

Assuming that the TRIO mXTEND™ chip antenna component (NN03-310) is placed in the clearance area of the PCB, see below the recommended footprint dimensions, to provide operation from 698 to 960 MHz, 1710 to 2690 MHz at port #1, and 3400 to 3800 MHz at port #2.

Measure	mm
A	12.0
B	23.0
C	3.0
D	0.5
E	1.0
F	8.5
G	2.0
H	2.5
I	10.0
J	7.0

Tolerance: ±0.05mm

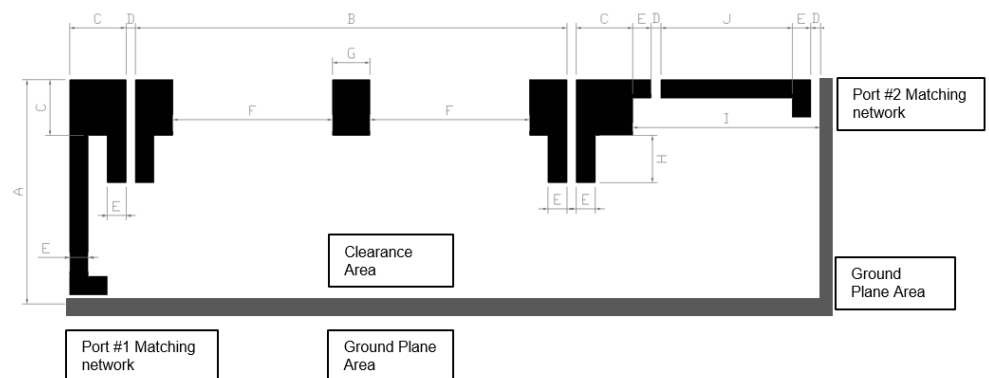


Figure 12 – Footprint dimensions for the single chip antenna component.

TRIO mXTEND[™] IoT Tracker

The TRIO mXTEND[™] chip antenna **enables Mobile, GNSS and Bluetooth connection simultaneously through a single antenna component**. Thanks to its modular, multiband and multiport configuration this chip antenna works in multiple frequency regions. In this application **triple coverage** in different frequency regions including 2G, GNSS and Bluetooth: 824-960 MHz, 1710-1990 MHz, 1561-1606 MHz and 2400-2500 MHz is obtained using the TRIO mXTEND[™] in three-port configuration. An example configuration on our Evaluation Board is seen as well as different matching network configurations used and the resulting test and simulation values.

QUICK REFERENCE GUIDE

Technical features	Port 1 824-960 MHz	Port 1 1710-1990 MHz	Port 2 1561-1606 MHz	Port 3 2400-2500MHz
Average Efficiency	> 50%	> 60%	> 50%	> 75%
Peak Gain	0.4 dBi	1.9 dBi	0.9 dBi	2.4 dBi
VSWR	< 2.8:1	< 2.1:1	< 2.1:1	< 2.0:1
Radiation Pattern	Omnidirectional			
Polarization	Linear			
Weight (approx.)	0.25 g.			
Temperature	-40 to +125 °C			
Impedance	50 Ω			
Dimensions (L x W x H)	30.0 mm x 3.0 mm x 1.0 mm			

Table 5 – Technical Features. Measures from the Evaluation Board. See Figure 13.

ELECTRICAL PERFORMANCE

EVALUATION BOARD

This Evaluation Board EB_NN03-310-2G-GNSS-BT integrates one TRIO mXTEND™ chip antenna component to provide operation from 824 to 960 MHz, 1710 to 1990 MHz at port 1, from 1561 to 1606 MHz at port 2 and 2400 to 2500 MHz at port 3.

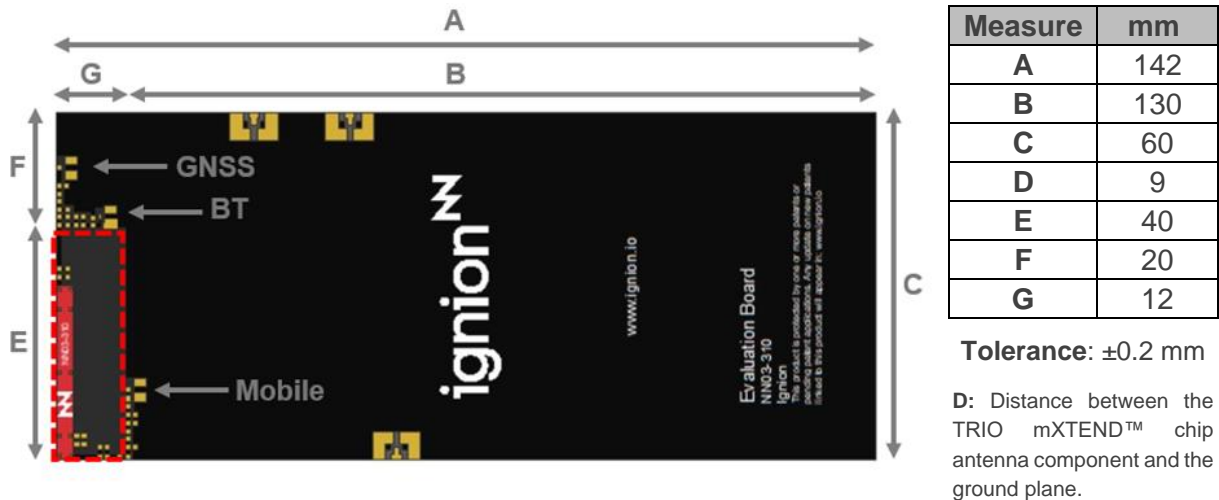


Figure 13 EB_NN03-310-2G-GNSS-BT. Evaluation Board for providing operation at 824 – 960MHz and 1710 – 1990MHz (Port 1), 1561 – 1606MHz (Port 2) and 2400 – 2500MHz (Port 3).

This product and/or its use is protected by at least one or more of the following [patents and patent applications](#) WO 2019008171, US 16/731755, EP 18736916.0, CN 201880045357.8; and other domestic and international patents pending. Additional information about patents related to this product is available at www.ignion.io/virtual-antenna/.

MATCHING NETWORK

TRIO mXTEND™ antenna booster needs a matching network to connect to your RF module. This section will present the proposed matching network and specs obtained in the corresponding Evaluation Board (**¡Error! No se encuentra el origen de la referencia.13**), which is an ideal case. Please note that different devices with different ground planes and different components nearby the TRIO mXTEND™ chip antenna component may need a different matching network. To ensure optimal results, the use of high-quality factor (Q) and tight tolerance components is highly recommended (e.g. Murata components (Figure 16, Figure 17, Figure 18)).

The antenna performance is always conditioned by its operating environment. Different devices with different printed circuit board sizes, components nearby the antenna, LCD's, batteries, covers, connectors, etc. affect the antenna performance. Accordingly, it is highly recommended placing pads compatible with 0402 and 0603 SMD components for a matching network as close as possible to the feeding point of the antenna element in the ground plane area, not in the clearance area. This provides a degree of freedom to tune the TRIO mXTEND™ chip antenna component once the design is finished and taking into account all elements of the system (batteries, displays, covers, etc.).

If you need assistance to design your matching network beyond this application note, please contact support@ignion.io, or if you are designing a **different device size** or a **different band of the sub-6GHz spectrum**, we can assist you in less than 24 hours. Please, try our free-of-charge¹ **NN Wireless Fast-Track** design service, you will get your chip antenna design including a custom matching network for your device in 24h³. Other related to NN's range of R&D services is available at: <https://ignion.io/design-center/engineering-support/>

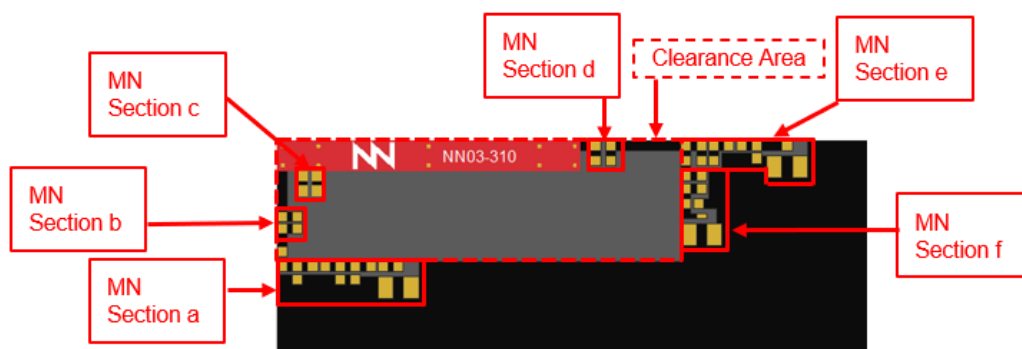


Figure 14 –TRIO mXTEND™ matching network layout

³ See terms and conditions for a free NN Wireless Fast-Track service in 24h at: <https://www.ignion.io/fast-track-project/>

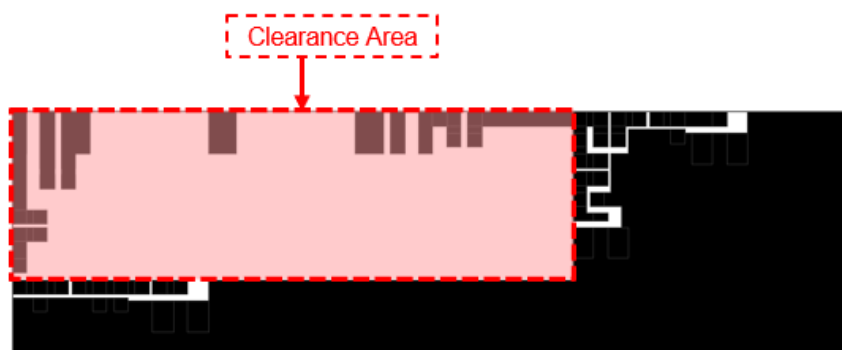


Figure 15 – TRIO mXTEND™ chip antenna component footprint

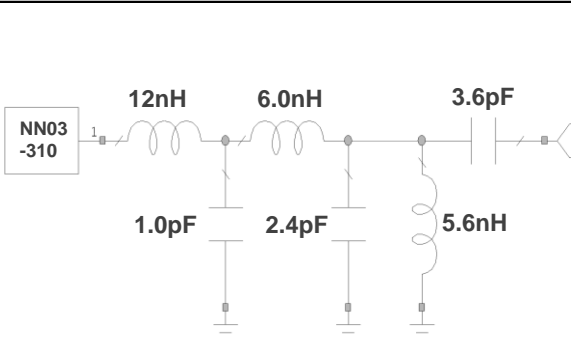
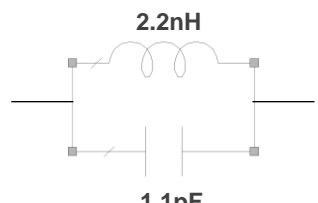
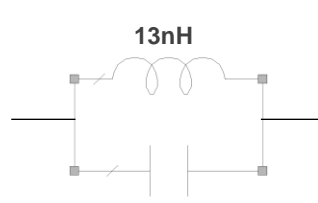
824 – 960 MHz and 1710 – 1990 MHz															
MN Section a	 <table border="1" data-bbox="941 918 1404 1254"> <thead> <tr> <th>Value</th> <th>Part Number</th> </tr> </thead> <tbody> <tr> <td>12 nH</td> <td>LQW18AN12NG80</td> </tr> <tr> <td>1.0 pF</td> <td>GJM1555C1H1R0WB01</td> </tr> <tr> <td>6.0 nH</td> <td>LQW18AN6N0G80</td> </tr> <tr> <td>2.4 pF</td> <td>GJM1555C1H2R4WB01</td> </tr> <tr> <td>5.6 nH</td> <td>LQW18AN5N6G80</td> </tr> <tr> <td>3.6pF</td> <td>GJM1555C1H3R6WB01</td> </tr> </tbody> </table>	Value	Part Number	12 nH	LQW18AN12NG80	1.0 pF	GJM1555C1H1R0WB01	6.0 nH	LQW18AN6N0G80	2.4 pF	GJM1555C1H2R4WB01	5.6 nH	LQW18AN5N6G80	3.6pF	GJM1555C1H3R6WB01
	Value	Part Number													
	12 nH	LQW18AN12NG80													
	1.0 pF	GJM1555C1H1R0WB01													
	6.0 nH	LQW18AN6N0G80													
	2.4 pF	GJM1555C1H2R4WB01													
	5.6 nH	LQW18AN5N6G80													
3.6pF	GJM1555C1H3R6WB01														
MN Section b	 <table border="1" data-bbox="941 1299 1404 1500"> <thead> <tr> <th>Value</th> <th>Part Number</th> </tr> </thead> <tbody> <tr> <td>2.2 nH</td> <td>LQW15AN2N2G80</td> </tr> <tr> <td>1.1 pF</td> <td>GJM1555C1H1R1WB01</td> </tr> </tbody> </table>	Value	Part Number	2.2 nH	LQW15AN2N2G80	1.1 pF	GJM1555C1H1R1WB01								
	Value	Part Number													
	2.2 nH	LQW15AN2N2G80													
1.1 pF	GJM1555C1H1R1WB01														
MN Section c	 <table border="1" data-bbox="941 1545 1404 1747"> <thead> <tr> <th>Value</th> <th>Part Number</th> </tr> </thead> <tbody> <tr> <td>13 nH</td> <td>LQW18AN13NG80</td> </tr> <tr> <td>0.1 pF</td> <td>GJM1555C1HR10WB01</td> </tr> </tbody> </table>	Value	Part Number	13 nH	LQW18AN13NG80	0.1 pF	GJM1555C1HR10WB01								
	Value	Part Number													
	13 nH	LQW18AN13NG80													
0.1 pF	GJM1555C1HR10WB01														

Figure 16 – Matching Network implemented in the Evaluation Board port 1 (Figure 13)

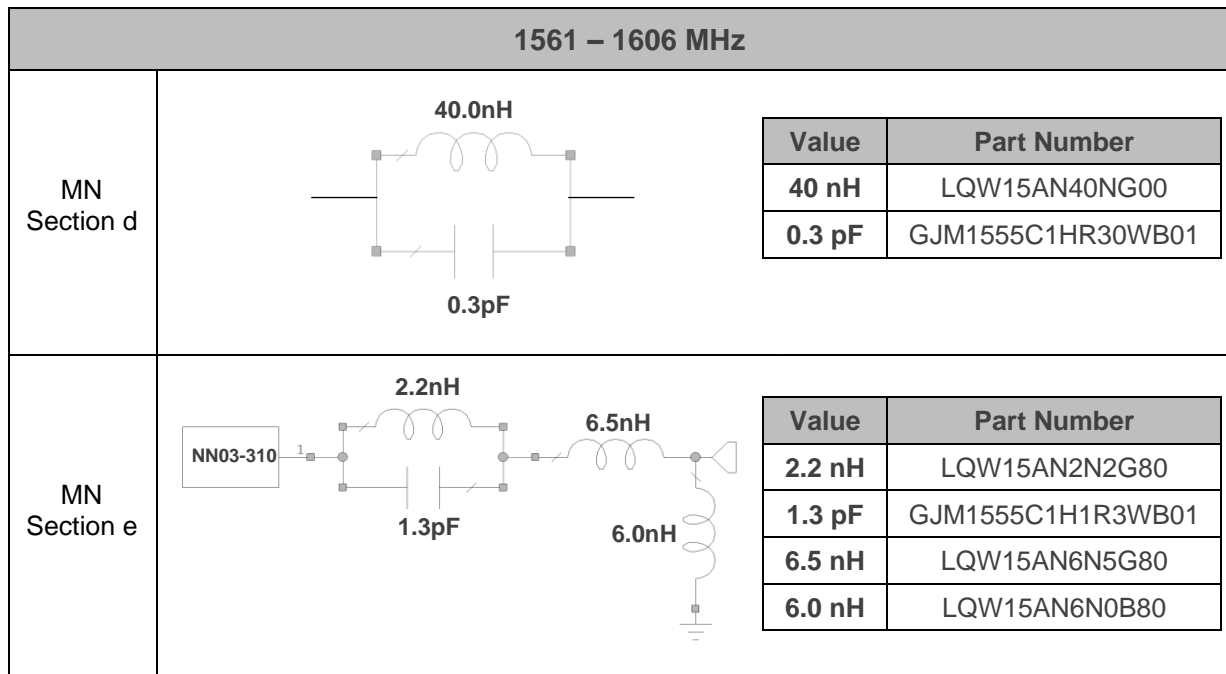


Figure 17– Matching Network implemented in the Evaluation Board port 2 (Figure 13)

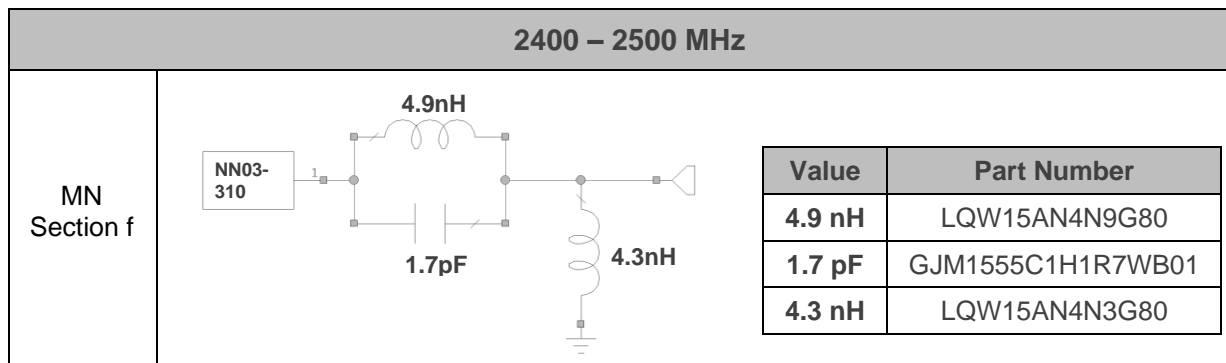


Figure 18– Matching Network implemented in the Evaluation Board port 3 (Figure 13).

VSWR AND TOTAL EFFICIENCY

VSWR (Voltage Standing Wave Ratio) and Total Efficiency versus Frequency (GHz).

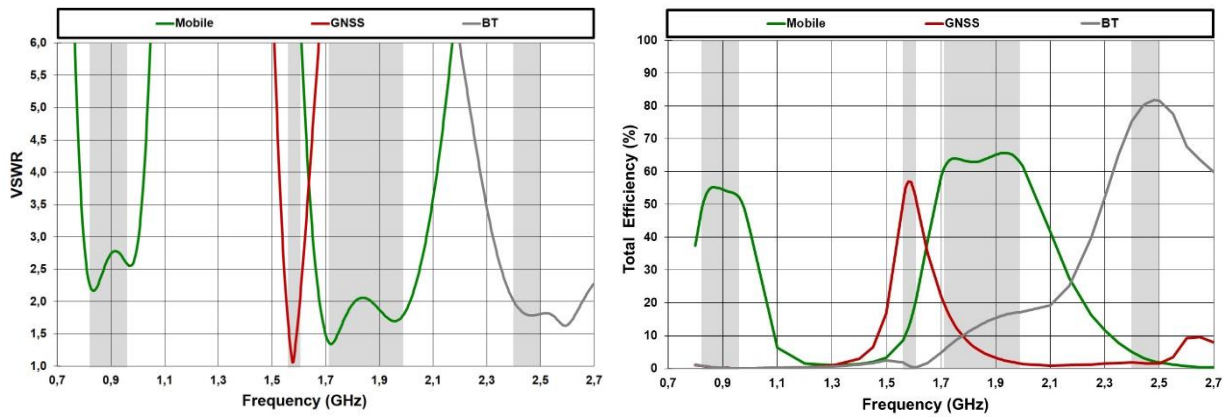


Figure 19 – VSWR and Total Efficiency for the different bands covered by the Evaluation Board from Figure 13. Simulated results obtained with CST.

TRANSMISSION COEFFICIENT

The transmission coefficient between the three ports is gathered herein.

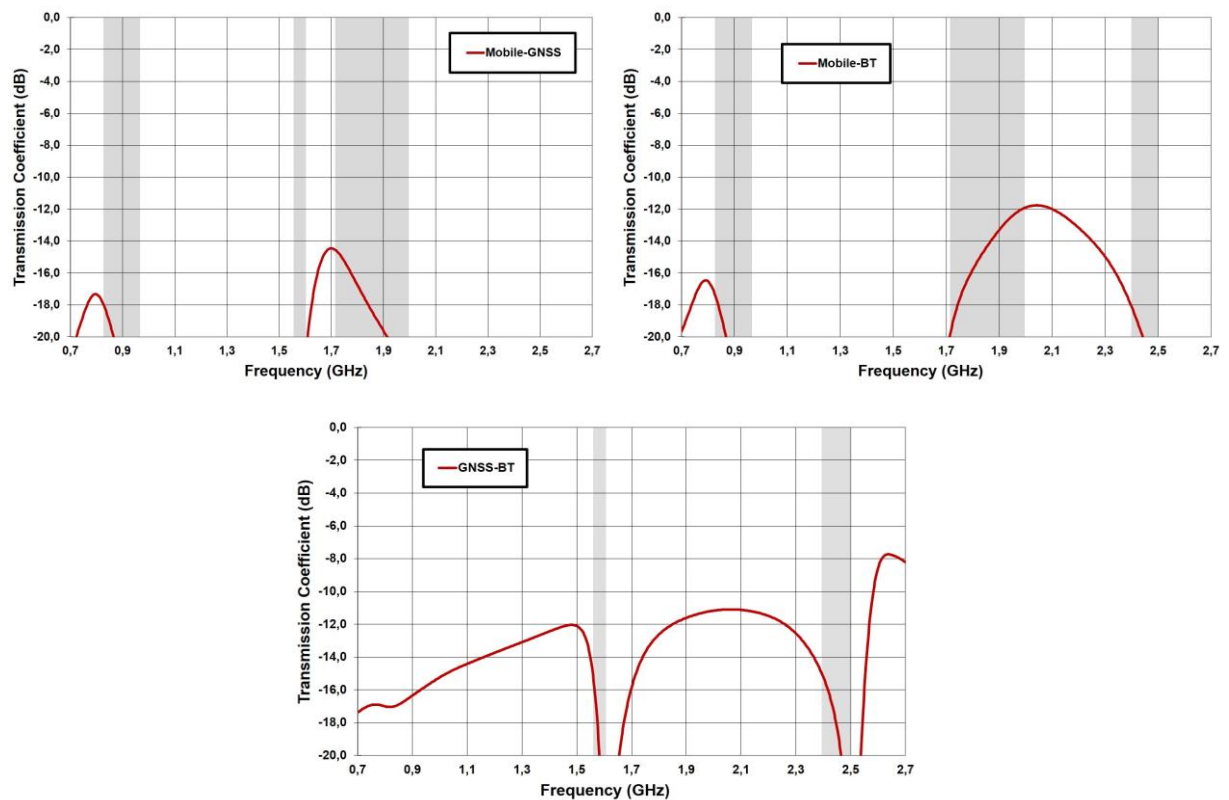


Figure 20 – Transmission coefficients between the ports of the Evaluation Board from Figure 13.

RECOMMENDED ANTENNA FOOTPRINT FOR NN03-310

The TRIO mXTEND[™] chip antenna component (NN03-310) must be placed in the clearance area of the PCB, see below the recommended footprint dimensions, to provide operation from 824 to 960 MHz, 1710 to 1990 MHz at port 1, from 1561 to 1606 MHz at port 2 and from 2400 to 2500 MHz at port 3.

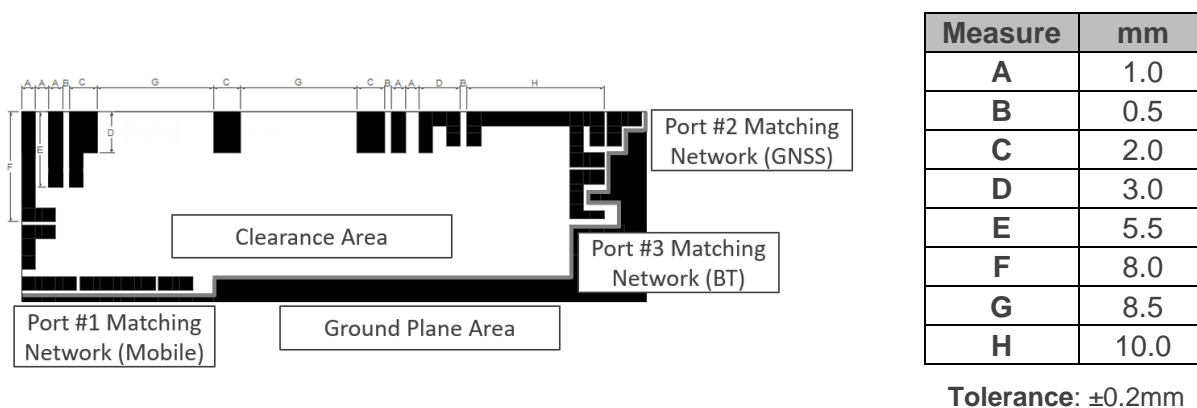
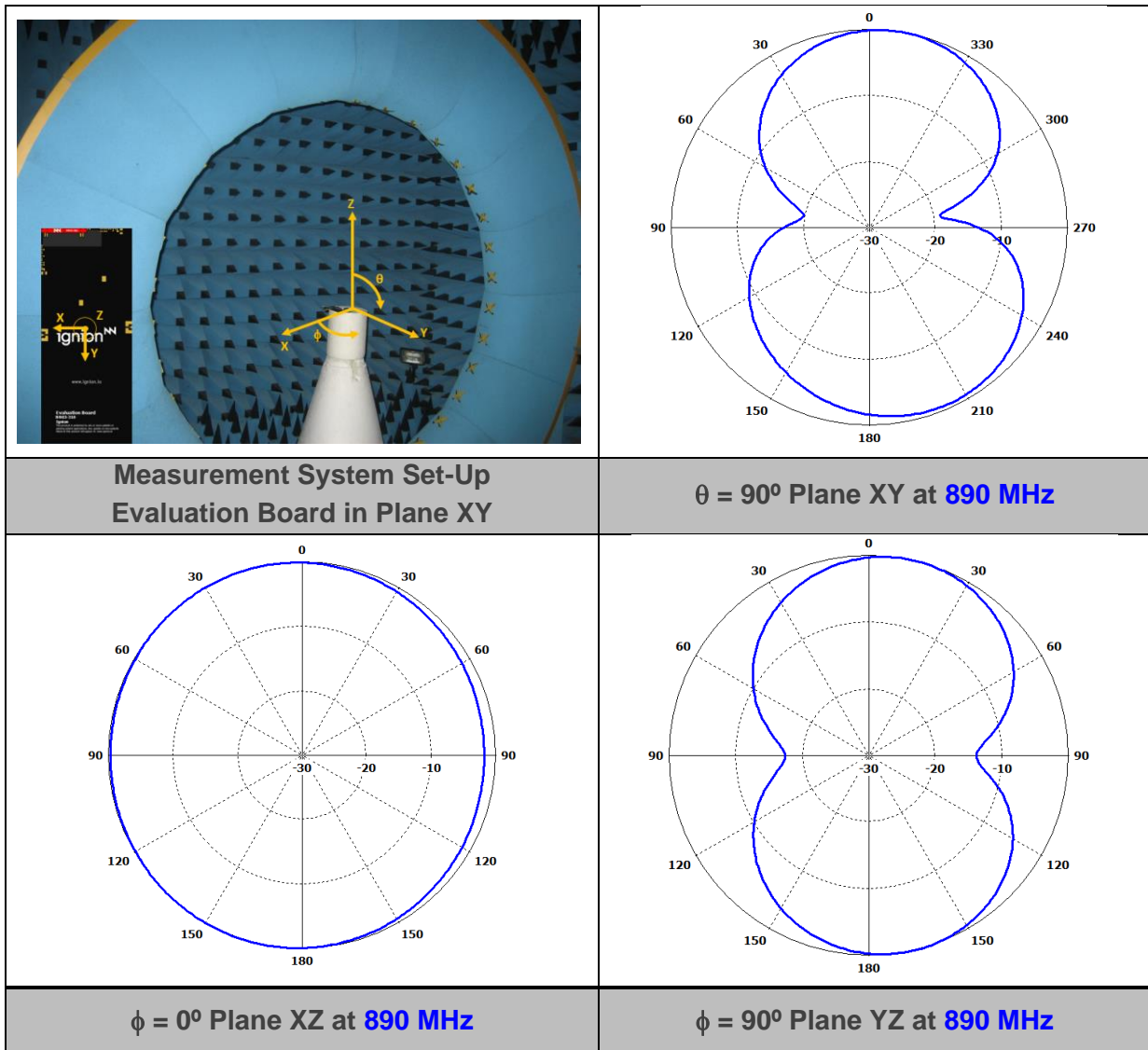


Figure 21 – Footprint dimensions for the NN03-310 chip antenna component.

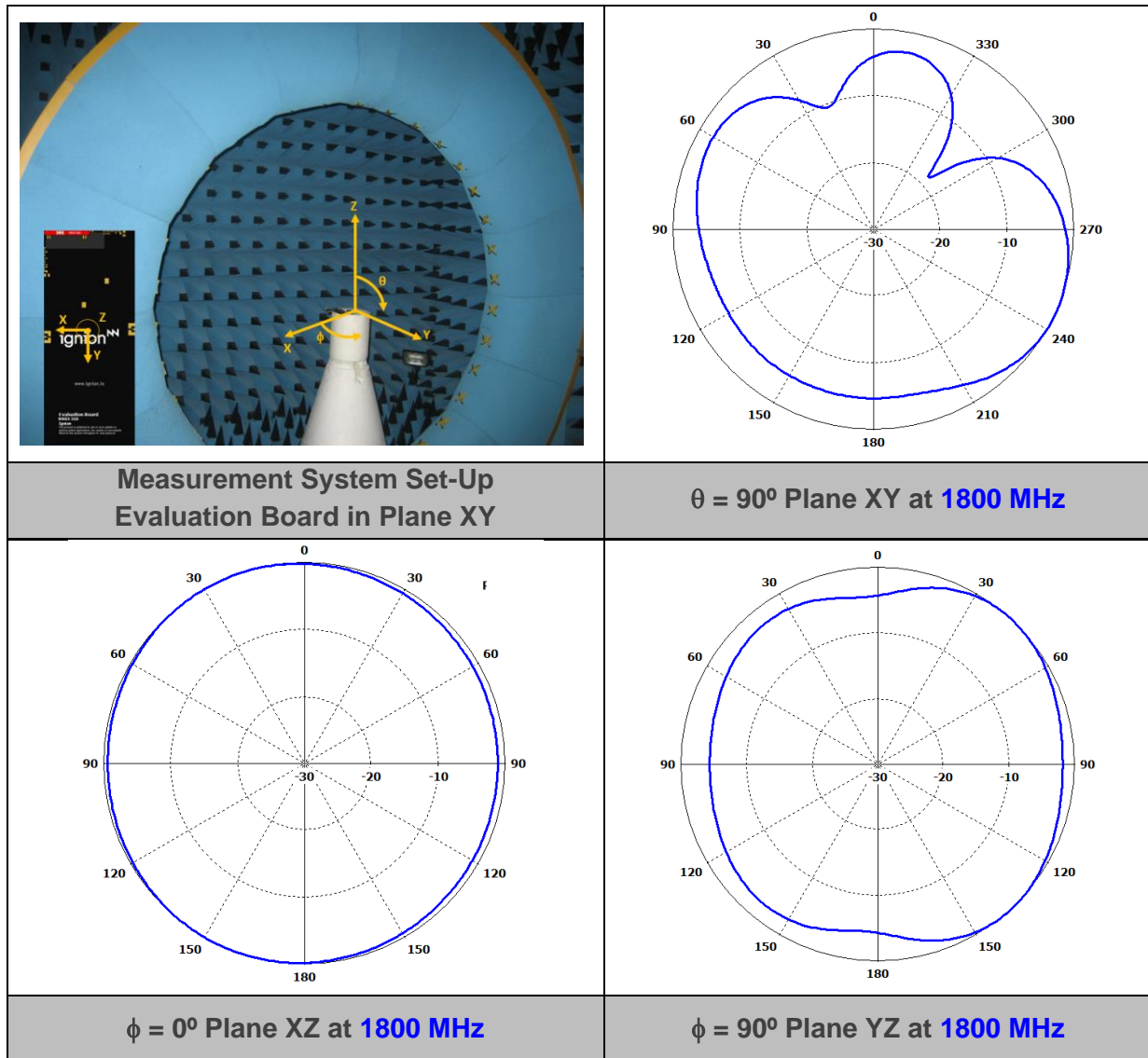
RADIATION PATTERNS (824 – 960 MHz), GAIN, AND EFFICIENCY



Gain	Peak Gain	0.4 dBi
	Average Gain across the band	0.08 dBi
	Gain Range across the band (min, max)	-0.6 \leftrightarrow 0.4 dBi
Efficiency	Peak Efficiency	55.3 %
	Average Efficiency across the band	53.7 %
	Efficiency Range across the band (min, max)	49.2 – 55.3 %

Table 6 – Antenna Gain and Total Efficiency from the Evaluation Board port 1 (Figure 13) within the 824MHz – 960MHz frequency range. Simulated results obtained with CST.

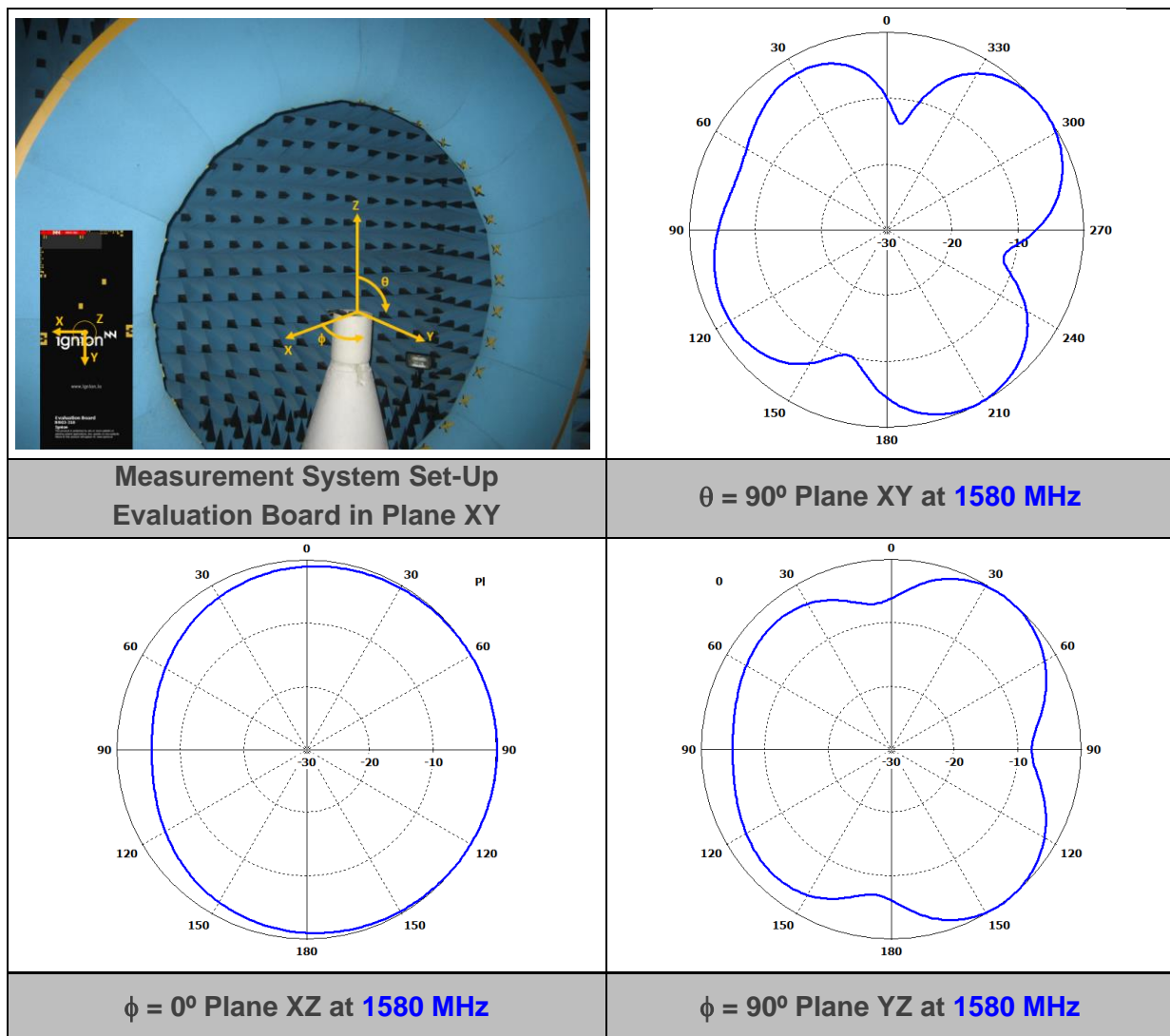
RADIATION PATTERNS (1710 – 1990 MHz), GAIN, AND EFFICIENCY



Gain	Peak Gain	1.9 dBi
	Average Gain across the band	1.5 dBi
	Gain Range across the band (min, max)	1.2 ↔ 1.9 dBi
Efficiency	Peak Efficiency	65.7 %
	Average Efficiency across the band	63.9 %
	Efficiency Range across the band (min, max)	61.0 – 65.7 %

Table 7 – Antenna Gain and Total Efficiency from the Evaluation Board port 1 (Figure 13) within the 1710MHz – 1990MHz frequency range. Simulated results obtained with CST.

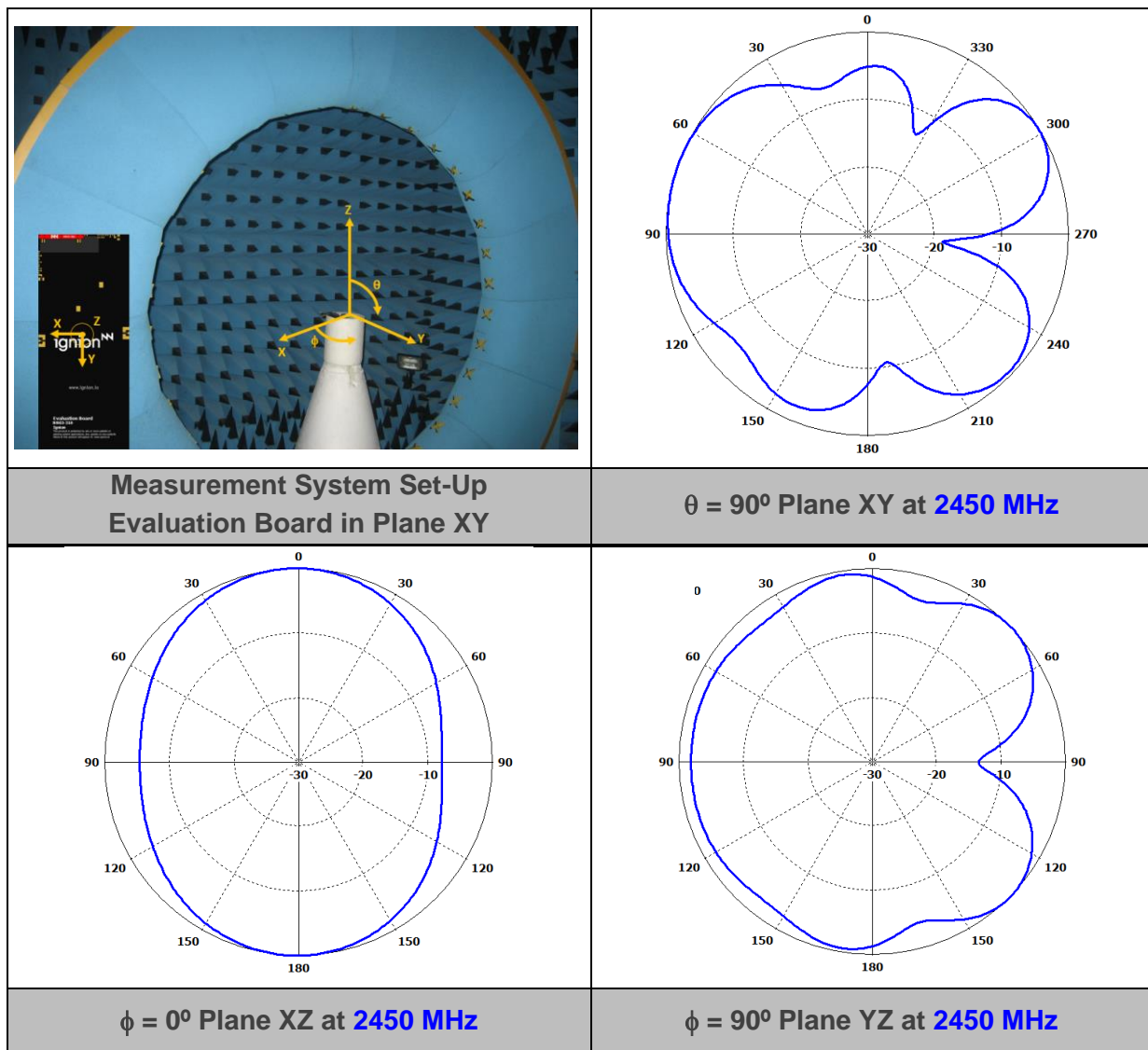
RADIATION PATTERNS (1561 – 1606 MHz), GAIN, AND EFFICIENCY



Gain	Peak Gain	0.9 dBi
	Average Gain across the band	0.7 dBi
	Gain Range across the band (min, max)	0.3 \leftrightarrow 0.9 dBi
Efficiency	Peak Efficiency	57.0 %
	Average Efficiency across the band	54.6 %
	Efficiency Range across the band (min, max)	50.8 – 57.0 %

Table 8 – Antenna Gain and Total Efficiency from the Evaluation Board port 2 (Figure 13) within the 1561MHz – 1606MHz frequency range. Simulated results obtained with CST.

RADIATION PATTERNS (2400 – 2500 MHz), GAIN, AND EFFICIENCY



Gain	Peak Gain	2.4 dBi
	Average Gain across the band	2.3 dBi
	Gain Range across the band (min, max)	2.1 \leftrightarrow 2.4 dBi
Efficiency	Peak Efficiency	81.8 %
	Average Efficiency across the band	79.9 %
	Efficiency Range across the band (min, max)	75.3 – 81.8 %

Table 9 – Antenna Gain and Total Efficiency from the Evaluation Board port 3 (Figure 13) within the 2400MHz – 2500MHz frequency range. Simulated results obtained with CST.

MECHANICAL SPECIFICATIONS

DIMENSIONS, TOLERANCES, AND RoHS

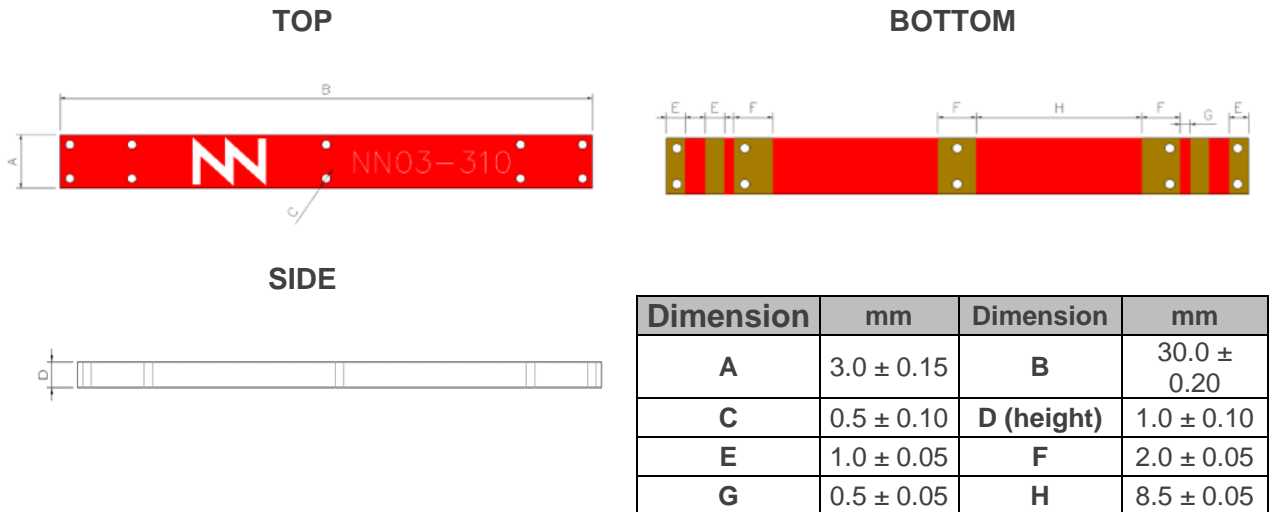
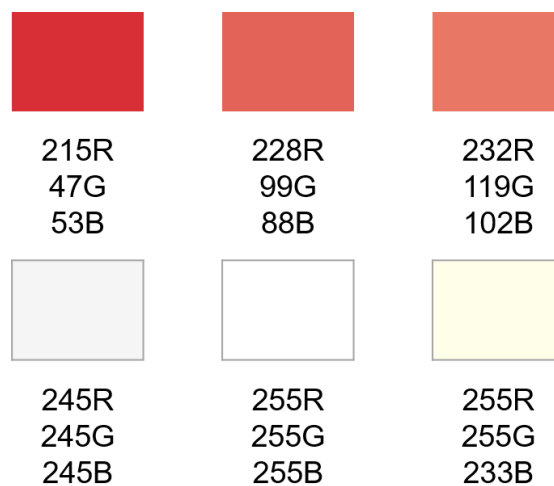


Figure 22 – TRIO mXTEND[™] chip antenna component dimensions and tolerances.

The TRIO mXTEND[™] chip antenna component NN03-310 is compliant with the restriction of the use of hazardous substances (**RoHS**). For more information, please contact support@ignion.io.

SPECIFICATIONS FOR THE INK

Next figure shows the range of the colors in the TRIO mXTEND[™] chip antenna component:



Acceptable color range

ANTENNA FOOTPRINT

Assuming that the TRIO mXTEND[™] chip antenna component NN03-310 is placed in the clearance area of the PCB, see below the recommended footprint dimensions.

Measure	mm
A	12.0
B	23.0
C	3.0
D	0.5
E	1.0
F	8.5
G	2.0
H	2.5

Tolerance: ±0.05mm

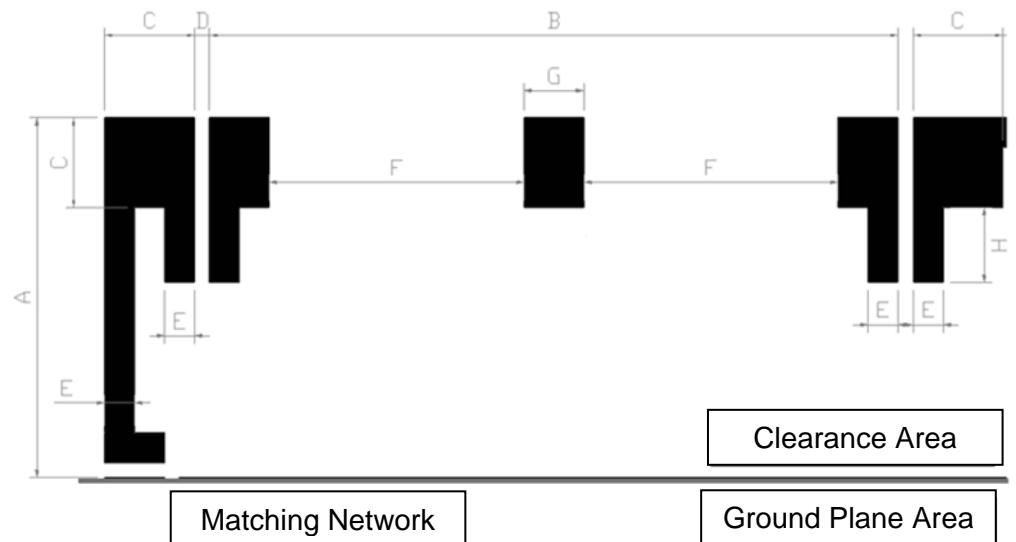


Figure 23 – Footprint dimensions for the single chip antenna component.

For additional support in the integration process, please contact support@ignion.io.

ASSEMBLY AND MANUFACTURING

Figure 24 shows the back and front views of the TRIO mXTEND[™] chip antenna component (NN03-310). Due to the product configuration, the feeding pad can only be the pad 1.

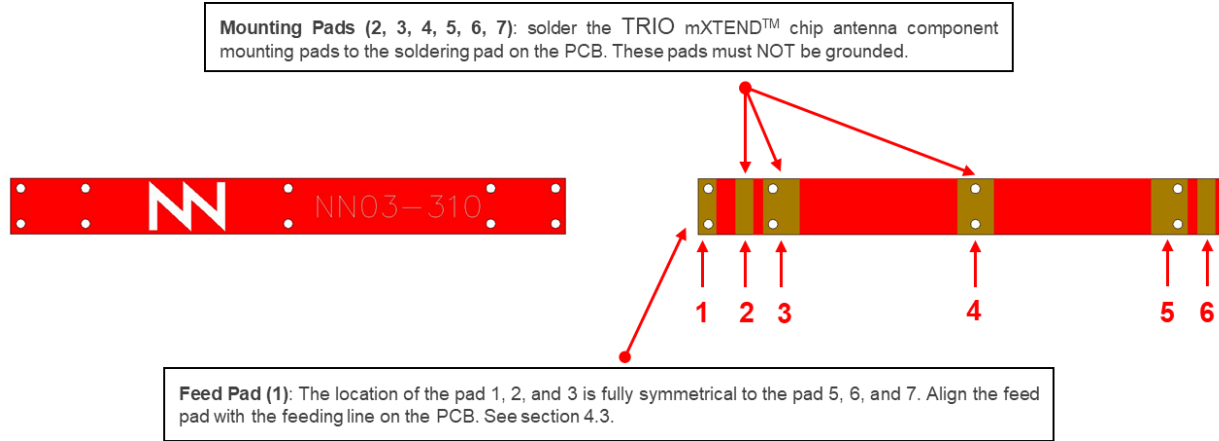


Figure 24 – Pads of the TRIO mXTEND[™] chip antenna component (NN03-310).

As a surface mount device (SMD), the TRIO mXTEND[™] chip antenna component is compatible with industry standard soldering processes. The basic assembly procedure for the TRIO mXTEND[™] chip antenna component is as follows:

1. Apply a solder paste on the pads of the PCB. Place the TRIO mXTEND[™] chip antenna component on the board.
2. Perform a reflow process according to the temperature profile detailed in Table 10, Figure 25.
3. After soldering the TRIO mXTEND[™] chip antenna component to the circuit board, perform a cleaning process to remove any residual flux. Ignion recommends conducting a visual inspection after the cleaning process to verify that all reflux has been removed.

The drawing below shows the soldering details obtained after a correct assembly process:

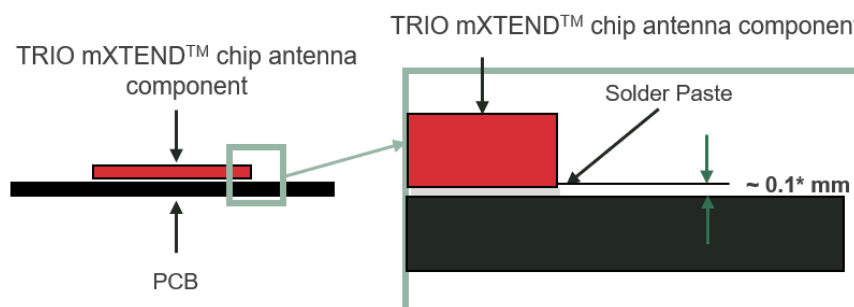


Figure 25 – Soldering Details.

NOTE(*): Solder paste thickness after the assembly process will depend on the thickness of the soldering stencil mask. A stencil thickness equal or larger than 127 microns (5 mils) is required.

The TRIO mXTEND[™] chip antenna component NN03-310 can be assembled following the Pb-free assembly process. According to the Standard **IPC/JEDEC J-STD-020C**, the temperature profile suggested is as follows:

Phase	Profile features	Pb-Free Assembly (SnAgCu)
RAMP-UP	Avg. Ramp-up Rate (T _{smax} to T _p)	3 °C / second (max.)
PREHEAT	- Temperature Min (T _{smin}) - Temperature Max (T _{smax}) - Time (t _{smin} to t _{smax})	150 °C 200 °C 60-180 seconds
REFLOW	- Temperature (T _L) - Total Time above T _L (t _L)	217 °C 60-150 seconds
PEAK	- Temperature (T _p) - Time (t _p)	260 °C 20-40 seconds
RAMP-DOWN	Rate	6 °C/second max
Time from 25 °C to Peak Temperature		8 minutes max

Table 10 – Recommended soldering temperatures.

Next graphic shows temperature profile (grey zone) for the TRIO mXTEND[™] chip antenna component assembly process reflows ovens.

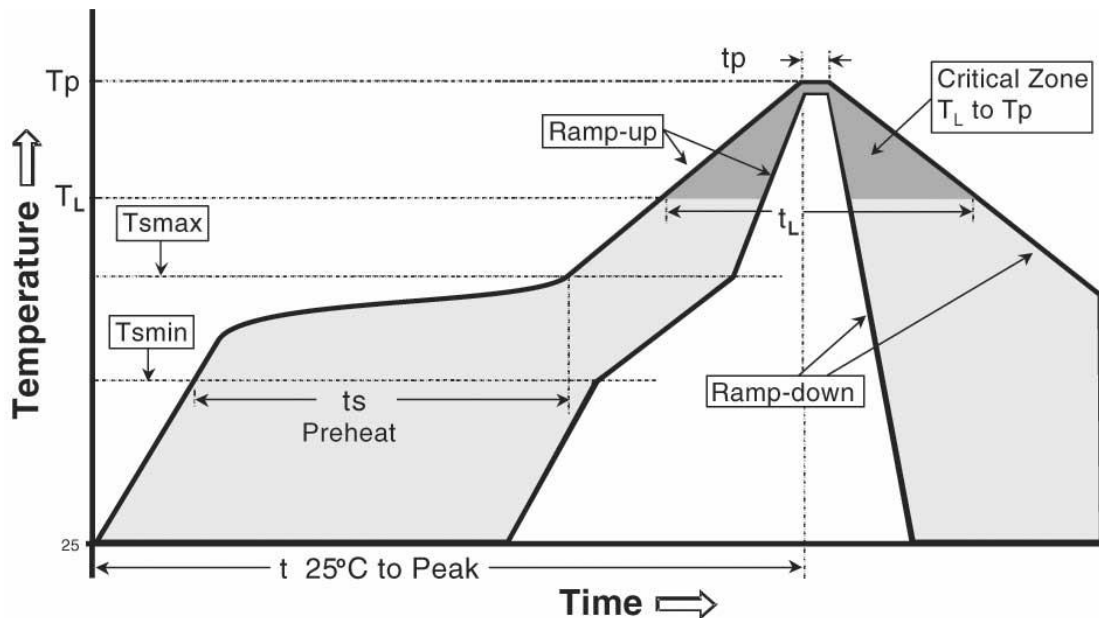
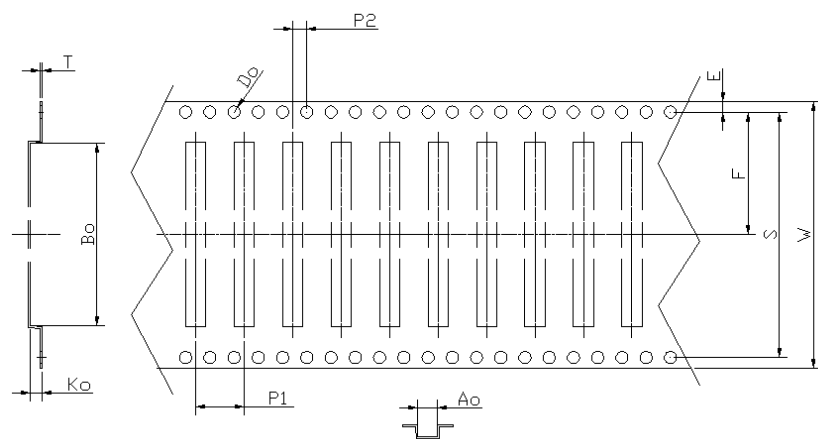


Figure 26 – Temperature profile.

PACKAGING

The TRIO mXTEND™ chip antenna component NN03-310 is delivered in tape and reel packaging.

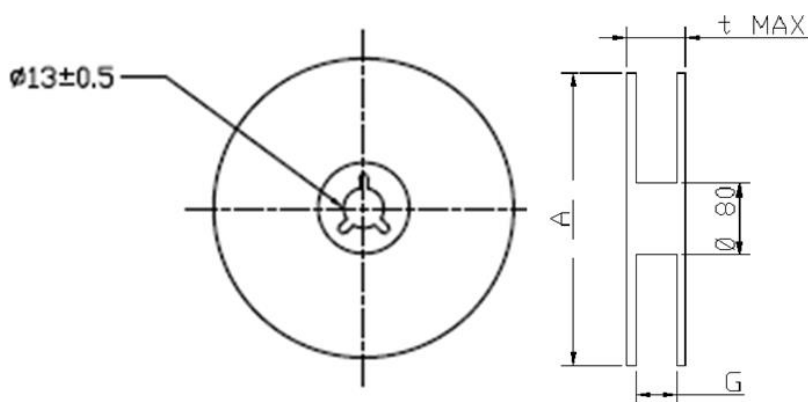


Measure	mm
Ao	3.3 ± 0.1
Bo	30.3 ± 0.1
Ko	2 ± 0.1
W	44 ± 0.3
D0	1.5 ± 0.05
P1	8 ± 0.1
P0	4 ± 0.1
P2	2 ± 0.1
E	1.75 ± 0.1
F	20.2 ± 0.1
S	40.4 ± 0.3
T	0.3 ± 0.05

Figure 27 – Tape dimensions and Tolerances.



Figure 28 – Image of the reel.



Measure	mm		
A	330	±	2.0
G	44.4	±	0.3
t MAX	48.4	±	0.3

Reel Capacity: 2500 pcs

Figure 29 – Reel Dimensions and Capacity.

PRODUCT CHANGE NOTIFICATION

This document is property of Ignion,
Not to disclose or copy without prior written consent

PCN Number: NN19100013

Notification Date: October 07th, 2019

Part Number identification:

Part Number changes, it will be applied in all the document of the company (User Manual, Data Sheet, ...)

Previous Part Number
FR01-S4-210

New Part Number
NN03-310

Reason for change:

<input type="checkbox"/> Specs (electrical/mechanical)	<input type="checkbox"/> Manufacturing location
<input type="checkbox"/> User Manual/Data Sheet	<input type="checkbox"/> Quality/Reliability
<input type="checkbox"/> Material/Composition	<input type="checkbox"/> Logistics
<input type="checkbox"/> Processing/Manufacturing	<input checked="" type="checkbox"/> Other: Part Number

Change description

1.- Part Number: From FR01-S4-210 FRACTUS to NN03-310 Ignion in the User Manual



Comments:

- 1.- Electrical and Mechanical specs remain the same
- 2.- Footprint in the PCB to solder the chip antenna remains the same

Identification method

1.- The part number on the antenna is different

User Manual	<input checked="" type="checkbox"/>	Available from: March 2020
Samples	<input checked="" type="checkbox"/>	Available from: April 2020

Ignion Contact:

	Sales	Supply Chain
Name:	Josep Portabella	Albert Vidal
Email:	josep.portabella@ignion.io	albert.vidal@ignion.io

Ignion products and solutions are protected by [Ignion patents](#).

All information contained within this document is property of Ignion and is subject to change without prior notice. Information is provided “as is” and without warranties. It is prohibited to copy or reproduce this information without prior approval.

Ignion is an ISO 9001:2015 certified company. All our antennas are lead-free and RoHS compliant.

ISO 9001: 2015 Certified

