

IEC Appliance Inlet C20 with Line Switch, 2-pole



Screw-on mounting
 from front side
 non-illuminated, black



Snap-in mounting from front side
 illuminated version
 green



See below:
[Approvals and Compliances](#)

Description

- Panel mount :
 Screw-on version from front or rear side, snap-in version front side
- 2 Functions :
 Appliance Inlet Protection class I , Line Switch 2-pole
- Quick connect terminals 6.3 x 0.8 mm

Characteristics

- All single elements are already wired
- Unwired versions available on request
- Line switch non-illuminated or illuminated
- Ideal for application with high transient loads
- Suitable for use in equipment according to IEC/UL 62368-1

Other versions on request

- Unwired versions
- Line switch with other rocker marking
- For protection class II
- Variant with notch for V-Lock mating Cordsets

References

Alternative: version with line filter [EC12](#)

Weblinks

[pdf data sheet](#), [html datasheet](#), [General Product Information](#), [Approvals](#), [Distributor-Stock-Check](#), [Accessories](#), [Detailed request for product](#)

Newly available variants corresponding to V-Lock mating cordset. The connector is equipped with a notch intended for use with the latching cordset. The cord latching system prevents against accidental removal of the cordset.

Technical Data

| | | | |
|-----------------------------------|---|-------------------------|---|
| Ratings IEC | 16A / 250VAC; 50Hz | Appliance inlet/-outlet | C20 acc. to IEC 60320-1, UL 60320-1, CSA C22.2 no. 60320-1 (for cold conditions) pin-temperature 70 °C, 16A, Protection Class I |
| Ratings UL/CSA | 20A / 250VAC; 60Hz | Line Switch | Rocker switch 2-pole, non-illuminated or illuminated, acc. to IEC 61058-1 Technical Details |
| Dielectric Strength | > 2.5kVAC between L-N > 3kVAC between L/N-PE (1 min/50Hz) | | |
| Allowable Operation Temperature | -25 °C to 70 °C | | |
| IP-Protection | front side IP40 acc. to IEC 60529 | | |
| Protection against electric shock | Suitable for appliances with protection class I acc. to IEC 61140 | | |
| Terminal | Quick connect terminals 6.3 x 0.8 mm | | |
| Panel Thickness S | Screw: max 8 mm Mounting screw torque max 0.5Nm Snap-in: 1.5/2/2.5 mm | | |
| Material: Housing | Thermoplastic, black, UL 94V-0 | | |



Approvals and Compliances

Detailed information on product approvals, code requirements, usage instructions and detailed test conditions can be looked up in [Details about Approvals](#)

SCHURTER products are designed for use in industrial environments. They have approvals from independent testing bodies according to national and international standards. Products with specific characteristics and requirements such as required in the automotive sector according to IATF 16949, medical technology according to ISO 13485 or in the aerospace industry can be offered exclusively with customer-specific, individual agreements by SCHURTER.





Approvals

The approval mark is used by the testing authorities to certify compliance with the safety requirements placed on electronic products.
 Approval Reference Type: EC11

| Approval Logo | Certificates | Certification Body | Description |
|--|---------------|--------------------|--|
|  | VDE Approvals | VDE | Certificate Number: 40001031 |
|  | UL Approvals | UL | UL File Number: E96454 |
|  | CCC Approvals | CCC | CCC Certificate Number: 2014010204683955 |



Product standards

Product standards that are referenced

| Organization | Design | Standard | Description |
|--|-----------------------|-----------------------|---|
|  | Designed according to | IEC 60320-1 | Appliance couplers for household and similar general purposes |
|  | Designed according to | IEC 61058-1 | Switches for appliances. Part 1. General requirements |
|  | Designed according to | UL 60320-1 | Standard for Attachment Plugs and Receptacles |
|  | Designed according to | CSA C22.2 no. 60320-1 | General Use Receptacles, Attachment Plugs, and Similar Wiring Devices |







Application standards

Application standards where the product can be used

| Organization | Design | Standard | Description |
|--|--------------------------------|----------------|--|
|  | Designed for applications acc. | IEC/UL 62368-1 | Audio/video, information and communication technology equipment - Part 1: Safety requirements |
|  | Designed for applications acc. | IEC 60335-1 | Safety of electrical appliances for household and similar purposes. Meets the requirements for appliances in unattended use. This includes the enhanced requirements of glow wire tests acc. to IEC 60695-2-11 or -12 & -13. |

Compliances

The product complies with following Guide Lines

| Identification | Details | Initiator | Description |
|--|--|-------------|--|
|  | CE declaration of conformity | SCHURTER AG | The CE marking declares that the product complies with the applicable requirements laid down in the harmonisation of Community legislation on its affixing in accordance with EU Regulation 765/2008. |
|  | UKCA declaration of conformity | SCHURTER AG | The UKCA marking declares that the product complies with the applicable requirements laid down in the British Amendment of Regulation (EC) 765/2008. |
|  | RoHS | SCHURTER AG | Directive RoHS 2011/65/EU, Amendment (EU) 2015/863 |
|  | China RoHS | SCHURTER AG | The law SJ / T 11363-2006 (China RoHS) has been in force since 1 March 2007. It is similar to the EU directive RoHS. |
|  | REACH | SCHURTER AG | On 1 June 2007, Regulation (EC) No 1907/2006 on the Registration, Evaluation, Authorization and Restriction of Chemicals 1 (abbreviated as "REACH") entered into force. |
|  | | SCHURTER AG | V-Lock system are based on a matching plug-dose combination. The connector is equipped with a notch intended for use with the latching cordset. The cord latching system prevents against accidental removal of the cordset. |
|  | White Paper Glow wire test | SCHURTER AG | Meets the requirements of IEC 60335-1 for appliances in unattended use. This includes the enhanced requirements of glow wire tests acc. to IEC 60695-2-11 or -12 & -13. |

Dimensions [mm]

Screw-on mounting

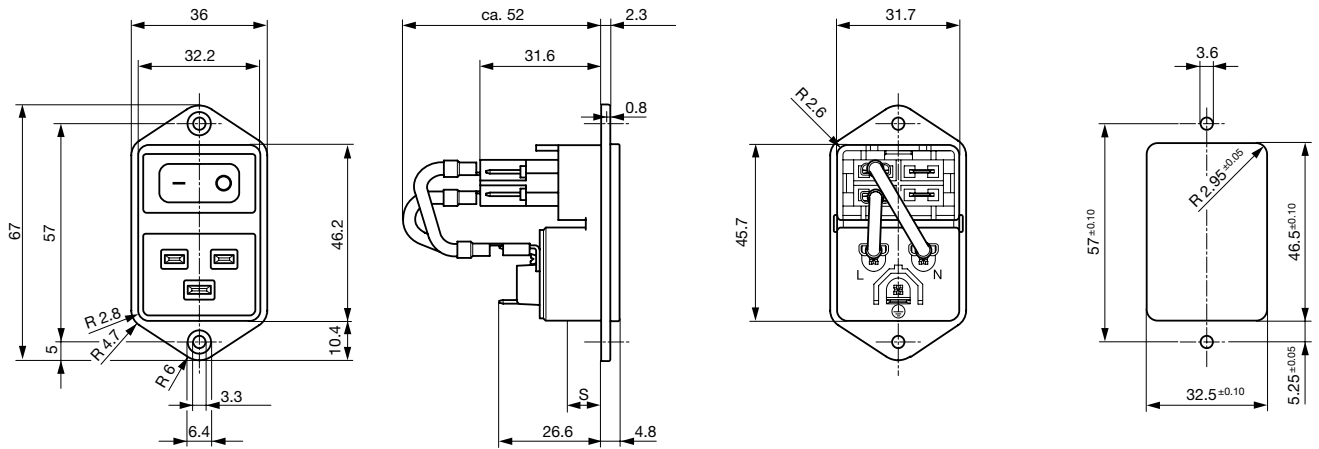

Snap-in mounting

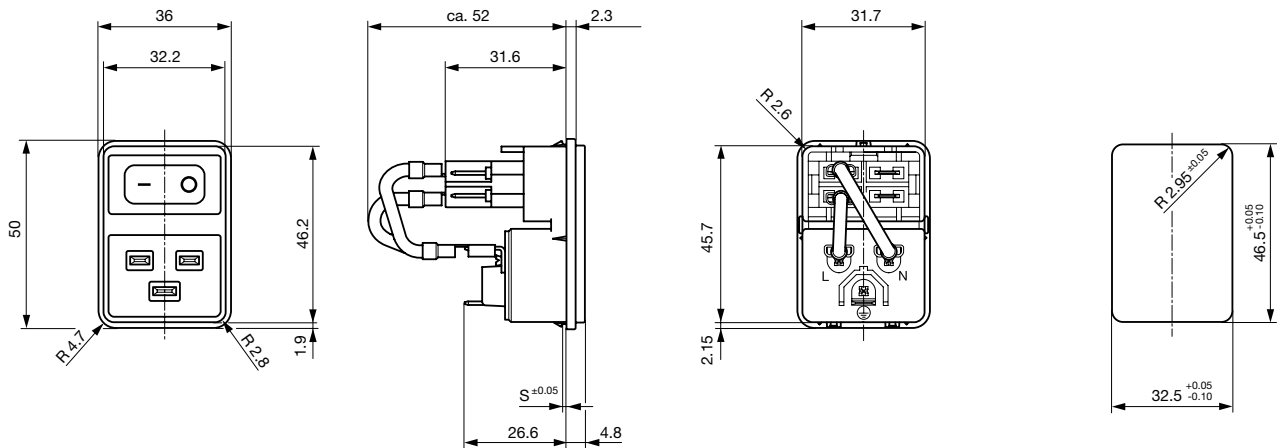

Diagrams

Line switch non-illuminated

Line switch illuminated

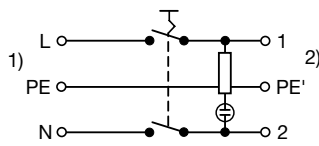
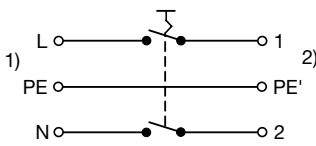







1) Line
2) Load

1) Line
2) Load

All Variants

| Panel mounting | Panel Thickness s [mm] | Illumination | Color | Internally wired | V-Lock | Order Number |
|----------------|------------------------|--------------|-------|------------------|--------|------------------|
| Snap-in | 1.5 | | - | ● | | EC11.0001.201 |
| Snap-in | 1.5 | | - | ● | ● | EC11.0001.201.21 |
| Snap-in | 1.5 | | - | | | EC11.0001.202 |
| Snap-in | 1.5 | ● | red | ● | | EC11.0021.201 |
| Snap-in | 1.5 | ● | red | ● | ● | EC11.0021.201.21 |
| Snap-in | 1.5 | ● | red | | | EC11.0021.202 |

| Panel mounting | Panel Thickness s [mm] | Illumination | Color | Internally wired | V-Lock | Order Number |
|----------------|---------------------------|--------------|-------|------------------|--------|--|
| Snap-in | 1.5 | ● | green | ● | | EC11.0031.201  |
| Snap-in | 1.5 | ● | green | ● | ● | EC11.0031.201.21 |
| Snap-in | 1.5 | ● | green | | | EC11.0031.202 |
| Snap-in | 2 | | - | ● | | EC11.0001.301  |
| Snap-in | 2 | | - | ● | ● | EC11.0001.301.21 |
| Snap-in | 2 | | - | | | EC11.0001.302 |
| Snap-in | 2 | ● | red | ● | | EC11.0021.301 |
| Snap-in | 2 | ● | red | ● | ● | EC11.0021.301.21 |
| Snap-in | 2 | ● | red | | | EC11.0021.302 |
| Snap-in | 2 | ● | green | ● | | EC11.0031.301 |
| Snap-in | 2 | ● | green | ● | ● | EC11.0031.301.21 |
| Snap-in | 2 | ● | green | | | EC11.0031.302 |
| Snap-in | 2.5 | | - | ● | | EC11.0001.401 |
| Snap-in | 2.5 | | - | | | EC11.0001.402 |
| Snap-in | 2.5 | ● | red | ● | | EC11.0021.401 |
| Snap-in | 2.5 | ● | red | | | EC11.0021.402 |
| Snap-in | 2.5 | ● | green | ● | | EC11.0031.401 |
| Snap-in | 2.5 | ● | green | | | EC11.0031.402 |
| Screw | - | | - | ● | | EC11.0001.001  |
| Screw | - | | - | ● | ● | EC11.0001.001.21  |
| Screw | - | | - | | | EC11.0001.002 |
| Screw | - | ● | red | ● | | EC11.0021.001  |
| Screw | - | ● | red | ● | ● | EC11.0021.001.21 |
| Screw | - | ● | red | | | EC11.0021.002 |
| Screw | - | ● | green | ● | | EC11.0031.001  |
| Screw | - | ● | green | ● | ● | EC11.0031.001.21 |
| Screw | - | ● | green | | | EC11.0031.002 |

 Most Popular.

Availability for all products can be searched real-time: <https://www.schurter.com/en/Stock-Check/Stock-Check-SCHURTER>

Packaging unit

25 Pcs

Accessories

Description



[Wire Harness](#)
 Wire harness for SCHURTER products



[Assorted Covers](#)
 Rear Cover

0859.0076



[RC320](#)
 Rear Cover for Power Entry Module



[Cord retaining kits](#)
 Cord retaining strain relief

Flat head, H

4700.0008

Mating Outlets/Connectors

Category / Description

[Connector Overview complete](#)



4795, Mounting: Power Cord, Cable Connector: IEC C19

4795

4790, Mounting: Power Cord, Screw Connector: IEC C19

4790

0104U, Mounting: Power Supply Cord, Screw clamps Connector: IEC C19

0104U

[Power Supply Cord Overview complete](#)

Cord Sets 10 A, North America, 3.0 m, Connector IEC C13, SJT 3x18 AWG, Transparent

4300.0920

Cord Sets 16 A, Europlug, 2.5 m, Connector IEC C19, H05VV-F3G1.5, black

6004.0395

Cord Sets 16 A, Interconnection, 1.0 m, Connector IEC C19, H05VV-F3G1.5, black

6020.0392

Cord Sets 16 A, Interconnection, 2.0 m, Connector IEC C19, H05VV-F3G1.5, black

6020.0394

Cord Sets 16 A, North America, 2.5 m, Connector IEC C19, SJT 3x14 AWG, black

6009.5195

