

EC28A EC28C

28mm Size Ring Type

A low-profile unit with 4mm height and good operation feel

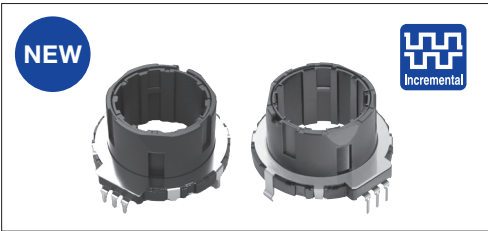

Typical Specifications

Items	Specifications
Rating	10mA 5V DC
Operating life	50,000 cycles
Operating temperature range	-40°C to +85°C -40°C to +90°C (EC28C)

Product Line

Structure	Actuator length (mm)	Detent torque (mN·m)	Number of detent	Number of pulse	Minimum order unit (pcs.)		Product No.	Drawing No.
					Japan	Export		
DIP	15	7±5	30	15	400	800	EC28A1520401	1
		12±7					EC28A1550401	
		20±10					EC28A1560401	
		12±7					EC28A1850402	
	20±10	EC28A1870401						
	25	20±10	30	15	420	840	EC28A1560501	2
Reflow	15	30 ± 15 (Initial) 20 ± 10 (After reflow)					480	480

Packing Specifications

Tray

Product No.	Number of packages (pcs.)		Export package measurements (mm)
	1 case /Japan	1 case /export packing	
EC28A15, EC28A18	400	800	366×509×287
EC28A1560501	420	840	360×540×380
EC28C1520401	480	480	290×440×205

Dimensions

Unit:mm

No.	Style	PC board mounting hole dimensions (Viewed from mounting side)
1		

Dimensions

Unit:mm

No.	Style	PC board mounting hole dimensions (Viewed from mounting side)
2		
3		

Output Wave

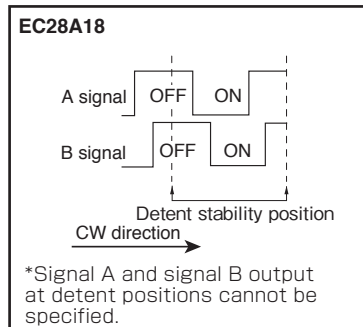
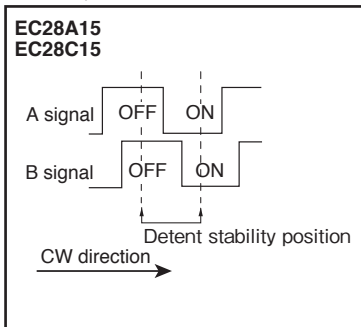



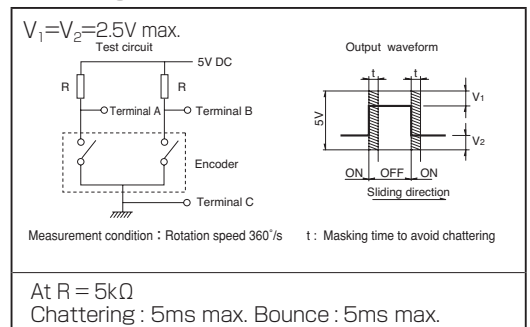









Sliding Noise



Encoders

List of Varieties

Type		Ring type					
		21mm size		28mm size		35mm size	
Series		EC21A	EC21C	EC28A	EC28C	EC35A	EC35AH
Photo							
Output		Incremental (Two phase A and B)					Incremental (Three phase A, B and C)
Shaft types		Ring type					
Number of pulse / Number of detent		9/18 15/30	15/30	15/30 18/18	15/30		6×ABC/18 10×ABC/30
Dimensions (mm)	W	21.6	22	28	28	35	
	D		21.6	29	29.5		
	H		4				
Operating temperature range		-40°C to +85°C			-40°C to +90°C	-40°C to +85°C	
Operating life		50,000 cycles					
Automotive use		●	●	●	●	●	●
Life cycle (availability)							
Electrical performance	Rating	10mA 5V DC					
	Max./min. operating current (Resistive load)	10mA / 1mA					
	Insulation resistance	100MΩ min. 250V DC					
	Voltage proof	300V AC for 1minute or 360V AC for 2s	300V AC for 1minute or 360V AC for 1s	300V AC for 1minute or 360V AC for 2s	300V AC for 1minute or 360V AC for 1s	300V AC for 1minute or 360V AC for 2s	
Mechanical performance	Detent torque	7±5mN·m 12±5mN·m 16±7mN·m	17±8mN·m (Initial) 12±7mN·m (After reflow)	7±5mN·m 12±7mN·m 20±10mN·m	30±15mN·m (Initial) 20±10mN·m (After reflow)	18±7mN·m 30±15mN·m	12±5mN·m 18±7mN·m 30±15mN·m
	Push-pull strength	Push	100N				
		Pull	100N				
Shaft configuration		Ring type					
Terminal type		Insertion					
Switch Specifications	Switch type	—	—	—	—	—	—
	Contact arrangement	—	—	—	—	—	—
	Travel (mm)	—	—	—	—	—	—
	Operating force (N)	—	—	—	—	—	—
	Switch ON position	—	—	—	—	—	—
	Rotational torque	—	—	—	—	—	—
	Rating	—	—	—	—	—	—
	Contact resistance	—	—	—	—	—	—
	Operating life	—	—	—	—	—	—
Page		302		305		307	308

Encoders Soldering Conditions 315
 Encoders Cautions 316

Note

● Indicates applicability to all products in the series.