



Features

- Incremental encoder / quadrature output
- Exceptionally long operating life
- Sturdy construction
- Bushing mount
- Available with PC board mounting bracket (optional)
- RoHS compliant*

ECW - Digital Contacting Encoder

Electrical Characteristics

Output	2-bit quadrature code, Channel A leads Channel B by 90 ° electrically turning clockwise (CW)
Closed Circuit Resistance	5 ohms maximum
Open Circuit Resistance	100 K ohms minimum
Contact Rating	10 milliamp @ 10 VDC or 0.1 watt maximum
Insulation Resistance (500 VDC)	1,000 megohms minimum
Dielectric Withstanding Voltage (MIL-STD-202 Method 301)	
Sea Level	1,000 VAC minimum
Electrical Travel	Continuous
Contact Bounce (15 RPM)	5 milliseconds maximum
RPM (Operating)	120 maximum
Phase Tolerance (CH A to CH B)	90 ° ± 72 °

Environmental Characteristics

Operating Temperature Range	-40 °C to +85 °C (-40 °F to 185 °F)
Storage Temperature Range	-40 °C to +85 °C (-40 °F to +185 °F)
Humidity	MIL-STD-202, Method 103B, Condition B
Vibration	15 G
Contact Bounce	0.1 millisecond maximum
Shock	50 G
Contact Bounce	0.1 millisecond maximum
Rotational Life	200,000 shaft revolutions
IP Rating	IP 40

Mechanical Characteristics

Mechanical Angle	Continuous
Running Torque (Detented)	0.5 to 1.5 N-cm (0.75 to 2.25 oz-in.)
Undetented Torque	0.17 to 1.0 N-cm (0.25 to 1.50 oz-in)
Mounting Torque	79 N-cm (7 lb.-in.) maximum
Shaft Side Load (Static)	4.5 kg (10 lbs.) minimum
Weight	Approximately 21 gms. (0.75 oz.)
Terminals	PC pin or solder lug
Soldering Condition	
Manual Soldering	96.5Sn/3.0Ag/0.5Cu solid wire or no-clean rosin cored wire 370 °C (700 °F) max. for 3 seconds
Wave Soldering	96.5Sn/3.0Ag/0.5Cu solder with no-clean flux 260 °C (500 °F) max. for 5 seconds
Wash processes	Not recommended
Marking	Manufacturer's name and trademark, part number, and date code.
Hardware	One lockwasher and one mounting nut are shipped with each encoder, except where noted in the part number.

Quadrature Output Table – This table is intended to show available outputs as currently defined.

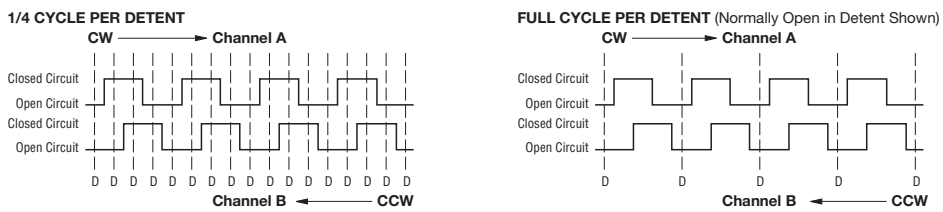

RECOMMENDED INCREMENTAL CONTROL DIAGRAM FOR USE WITH A DEBOUNCE CIRCUIT

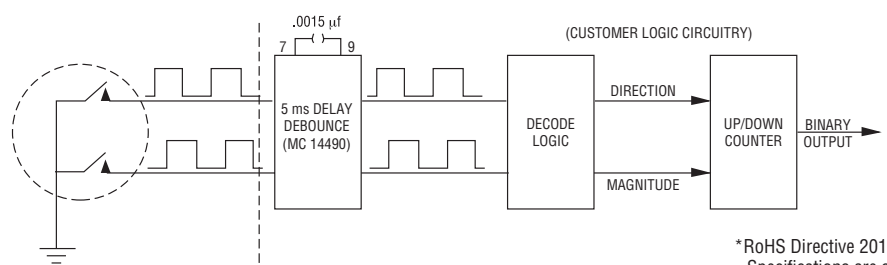

*RoHS Directive 2015/863, Mar 31, 2015 and Annex. Specifications are subject to change without notice. Users should verify actual device performance in their specific applications. The products described herein and this document are subject to specific legal disclaimers as set forth on the last page of this document, and at www.bourns.com/docs/legal/disclaimer.pdf.

Dimensional Drawings

BUSHING MOUNTED - HOUSING A Rear-Facing Terminals

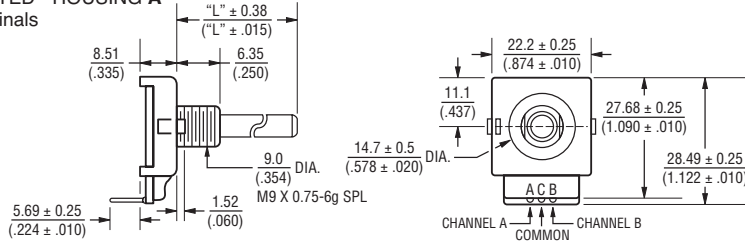

PANEL HOLE DIMENSIONS Bushing Mounted

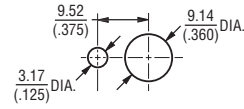

PCB BRACKET MOUNTED - HOUSING B Dimensions not given are the same as Bushing Mounted.

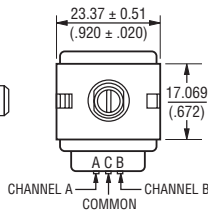
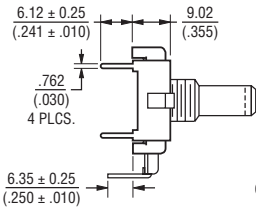

PCB MOUNTING DIMENSIONS (Housing Styles B and E)

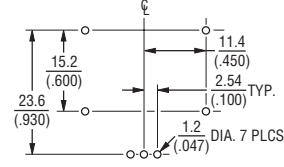

SOLDER HOLES - HOUSING C

Dimensions not given are the same as Bushing Mounted.

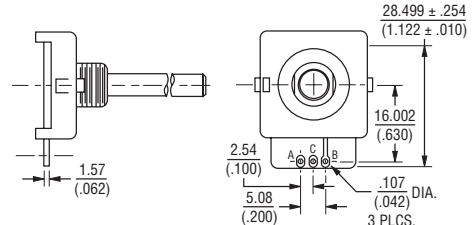

SNAP-IN MOUNT - Housing G

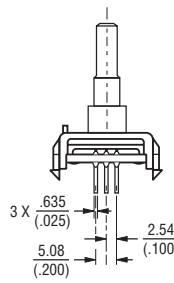
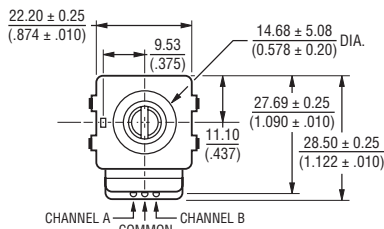
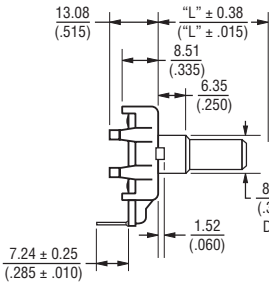

PCB MOUNTING DIMENSIONS

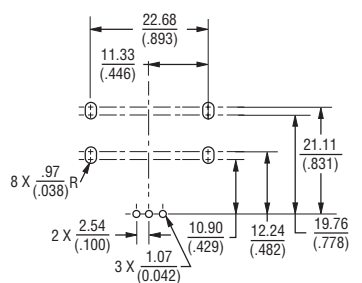

Shaft Style B

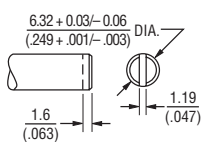

Shaft Style C

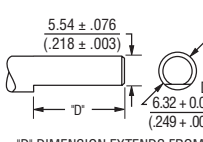

Shaft Style J

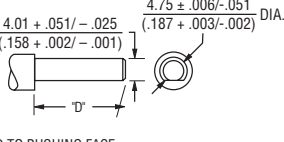

Shaft Style R

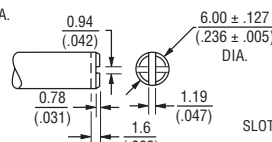

Shaft Style Y

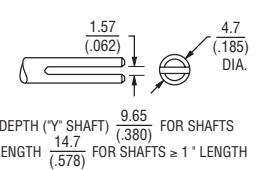

BUSHING MOUNTED - HOUSING H Front-Facing Terminals

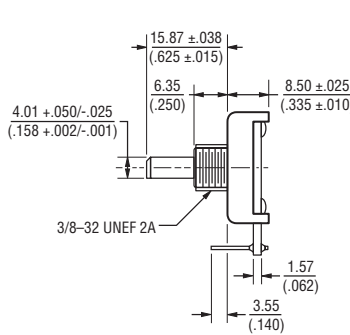
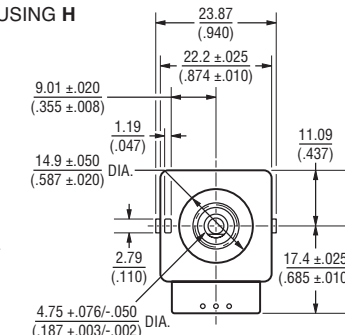
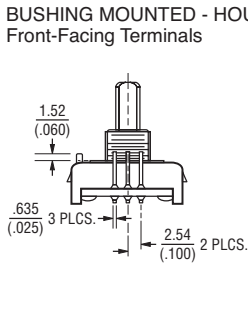

FOR TOLERANCES NOT SHOWN

.XX ± .25 (.010) .XXX ± .13 (.005)

SHAFT DIMENSIONS ± 1/32"

DIMENSIONS: MM (IN)

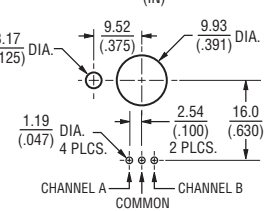

Specifications are subject to change without notice.

Users should verify actual device performance in their specific applications.

The products described herein and this document are subject to specific legal disclaimers as set forth on the last page of this document, and at www.bourns.com/docs/legal/disclaimer.pdf.

ECW - Digital Contacting Encoder

BOURNS®

How to Order

PART NUMBERING SYSTEM

E C W 1 J - B 2 4 - B C 0 0 2 4 L

Code	Rotational Life
C	200,000 Revolutions

BUSHING CONFIGURATION	
Code	Description
W	9 mm x 1/4 " Length. Threaded M9x0.75
L	9 mm x 3/8 " Length. Threaded M9x0.75 (Use B shaft only.)
T	9 mm x 1/4 ". No Thread.

SWITCHING CONFIGURATION (In Detent Position)
Applies to performance codes B0012 and C0024 only, use code "0" for all other performance codes.

Code	Description
0	Not Applicable
1	Normally Open

ANTI-ROTATION LUG POSITION

Code	Description
J	9:00 Position
D	None

SHAFT STYLE (See Outline Drawing for Details)

Code	Description
B	Plain with Inserted Slot (1/4 " Dia.)
C	Single Flatted (1/4 " Dia.)
R	Plain with Cross Slot (6 mm Dia.)
Y	Split Shaft Version (.185 " Dia.)
J	Flatted Shaft (3/16 " Dia.)

RoHS IDENTIFIER	
Code	Description
L	Compliant

PERFORMANCE CODE

Code	Detents	Cycles/Rev.
E0006	0	6
E0009	0	9
E0012	0	12
E0024	0	24
E0036	0	36
B0012	12	12
C0006	24	6
C0024		24
D0009	36	9

HOUSING TERMINAL CONFIGURATION (X indicates "Equipped With")

Features	Code									
	A	B	C	D	E	F	G*	H	K	
Terminal Cover	X	X			X		X			
Rear-Facing Terminals	X	X			X		X			
Solder Holes			X	X		X				
PCB Bracket		X		X	X	X				
Hardware Included	X		X		X	X		X		
Snap-In Mount								X		
Forward-Facing Terminals									X X	

*Bushing code T only.

SHAFT LENGTH (FMS)

Code	Description	Available Shaft Styles
16	1/2 " Length	B
20	5/8 " (15.9 mm) Length	J
24	3/4 " (19 mm) Length	B, C, J, Y
28	7/8 " (22.2 mm) Length	B, C, J, Y
32	1 " (25.4 mm) Length	B, C, J, Y
36	1-1/8 " (28.6 mm) Length	B, C, J, Y
Metric		
19	19 mm Length	R
22	22 mm Length	R
24	24 mm Length	R

The sample part number demonstrates the identification code for Bourns contacting encoders.

Boldface features are Bourns standard options. All others are available with higher minimum order quantities.

REV. 04/15/20

Specifications are subject to change without notice.

Users should verify actual device performance in their specific applications.

The products described herein and this document are subject to specific legal disclaimers as set forth on the last page of this document, and at www.bourns.com/docs/legal/disclaimer.pdf.