

**GLASS PASSIVATED SUPER FAST
SILICON SURFACE MOUNT BRIDGE RECTIFIER
VOLTAGE RANGE 50 to 600 Volts CURRENT 1.0 Ampere**

FEATURES

- * Surge overload rating - 40 amperes peak
- * Ideal for printed circuit board
- * Reliable low cost construction utilizing molded
- * Glass passivated device
- * Polarity symbols molded on body
- * Mounting position: Any

MECHANICAL DATA

- * Epoxy: Device has UL flammability classification 94V-O



DB-S

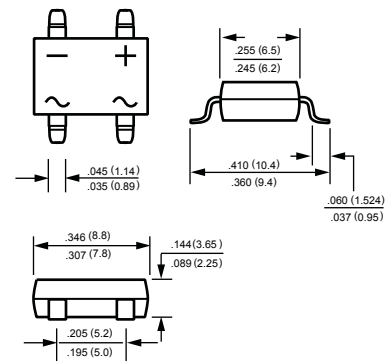

MAXIMUM RATINGS AND ELECTRICAL CHARACTERISTICS

Ratings at 25 °C ambient temperature unless otherwise specified.
Resistive or inductive load.

MAXIMUM RATINGS (At $T_A = 25^\circ\text{C}$ unless otherwise noted)

RATINGS	SYMBOL	EDB101S	EDB102S	EDB103S	EDB104S	EDB105S	EDB106S	EDB107S	UNITS
Maximum Recurrent Peak Reverse Voltage	V_{RRM}	50	100	150	200	300	400	600	Volts
Maximum RMS Bridge Input Voltage	V_{RMS}	35	70	105	140	210	280	420	Volts
Maximum DC Blocking Voltage	V_{DC}	50	100	150	200	300	400	600	Volts
Maximum Average Forward Output Current at $T_A = 55^\circ\text{C}$	I_O	1.0							Amps
Peak Forward Surge Current 8.3 ms single half sine-wave superimposed on rated load (JEDEC method)	I_{FSM}	30							Amps
Typical Current Square Time	I^2T	3.7							A^2S
	$R_{\theta JA}$	38							$^\circ\text{C}/\text{W}$
Typical Thermal Resistance (Note 3)	$R_{\theta JL}$	12							
	Typical Junction Capacitance (Note 2)	C_J	15			10			pF
Operating and Storage Temperature Range	T_J, T_{STG}	-55 to + 150							$^\circ\text{C}$

ELECTRICAL CHARACTERISTICS (At $T_A = 25^\circ\text{C}$ unless otherwise noted)

CHARACTERISTICS	SYMBOL	EDB101S	EDB102S	EDB103S	EDB104S	EDB105S	EDB106S	EDB107S	UNITS	
Maximum Forward Voltage at 1.0A DC	V_F	1.05			1.35		1.70		Volts	
Maximum Reverse Current at Rated DC Blocking Voltage per element	I_R	@ $T_A = 25^\circ\text{C}$			5.0					μAmps
		@ $T_A = 100^\circ\text{C}$			100					μAmps
Maximum Reverse Recovery Time (Note 1)	t_{rr}	50								nSec

Note: 1. Test Conditions: $I_F=0.5\text{A}, I_R=1.0\text{A}, I_{RR}=-0.25\text{A}$.
2. Measured at 1MHz and applied reverse voltage of 4.0 volts.
3. Thermal Resistance : Mounted on PCB.

RATING AND CHARACTERISTICS CURVES (EDB101S THRU EDB107S)

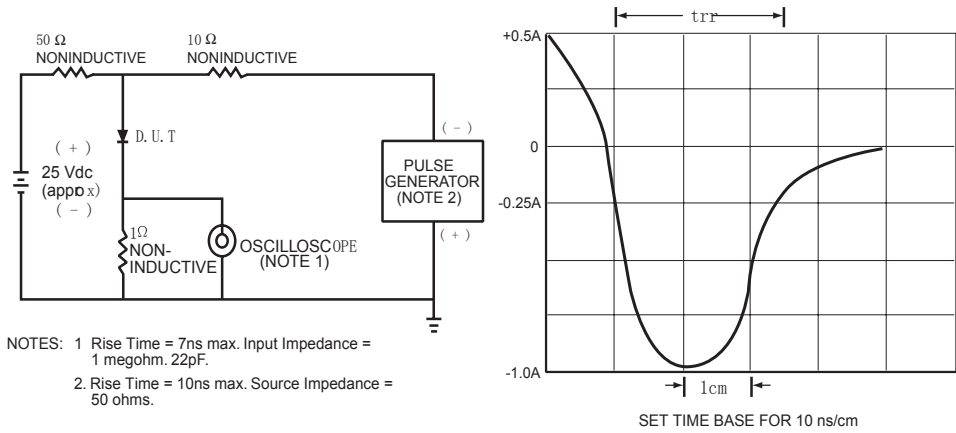

FIG.1 TEST CIRCUIT DIAGRAM AND REVERSE RECOVERY TIME CHARACTERISTIC

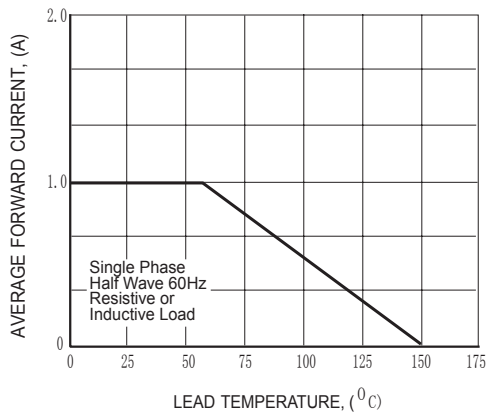

FIG.2 TYPICAL FORWARD CURRENT DERATING CURVE

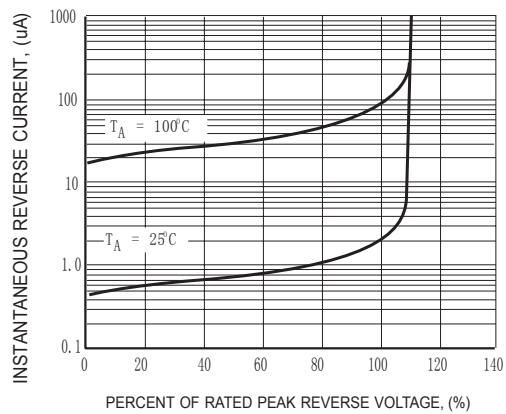

FIG.3 TYPICAL REVERSE CHARACTERISTICS

RATING AND CHARACTERISTICS CURVES (EDB101S THRU EDB107S)

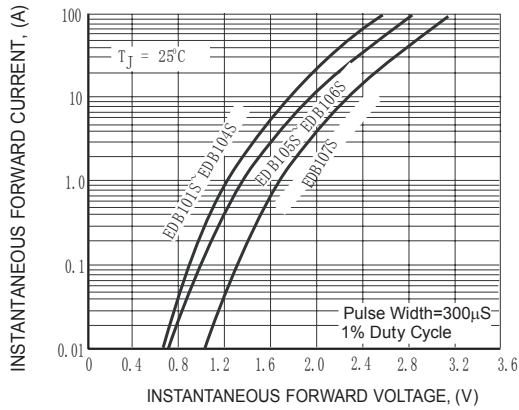

FIG. 4 TYPICAL INSTANTANEOUS FORWARD CHARACTERISTICS

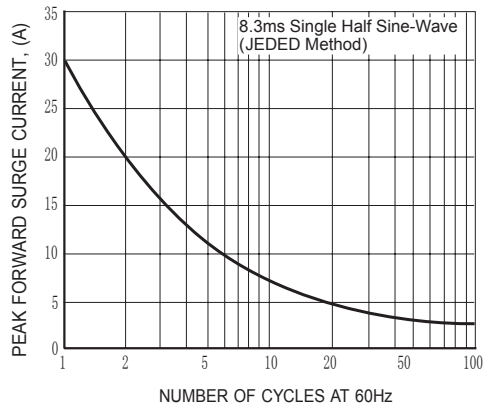

FIG. 5 MAXIMUM NON-REPETITIVE FORWARD SURGE CURRENT

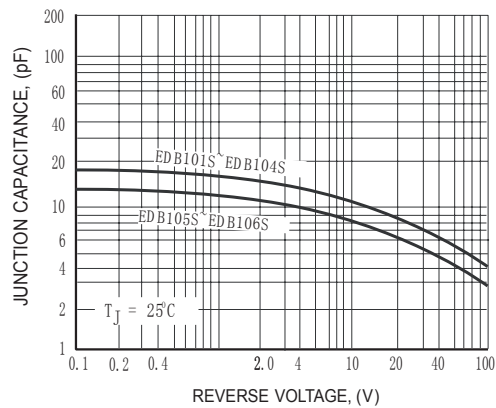

FIG. 6 TYPICAL JUNCTION CAPACITANCE



RECTRON

Attachment information about EDB10XS

1. Internal Circuit

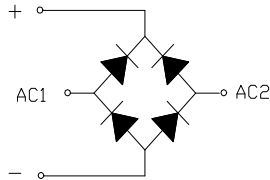

2. Marking on the body

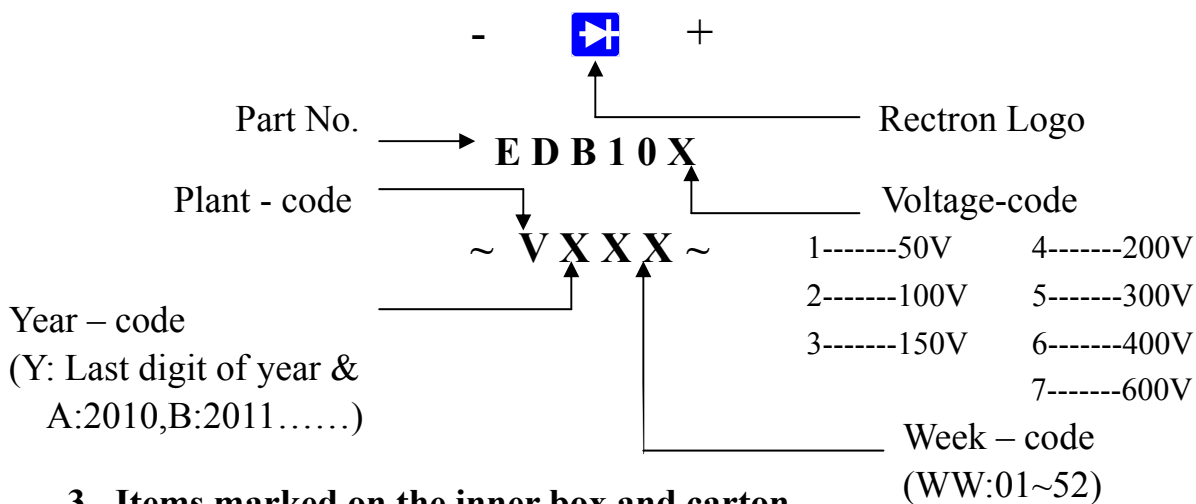

3. Items marked on the inner box and carton

3.1 On the box (for -B)

CUSTOMER
TYPE
LOT NO.
QUANTITY
Q.A.
DATE

3.2 On the carton

CUSTOMER
TYPE
QUANTITY
LOT NO.
REMARK

PACKAGING OF DIODE AND BRIDGE RECTIFIERS

BULK PACK

PACKAGE	PACKING CODE	EA PER BOX	INNER BOX SIZE (mm)	CARTON SIZE (mm)	EA PER CARTON	WEIGHT(Kg)
DB-S	-C	4,000	450*140*84	464*305*283	24,000	18.44

REEL PACK

PACKAGE	PACKING CODE	EA PER REEL	EA PER INNER BOX	COMPONENT SPACE (mm)	TAPE SPACE (mm)	REEL DIA (mm)	CARTON SIZE (mm)	EA PER CARTON	GROSS WEIGHT(Kg)
DB-S	-T/W	1,000	1,000	9.5	52	330	360*355*360	8,000	9.8