

**GLASS PASSIVATED SUPER FAST  
SILICON SURFACE MOUNT BRIDGE RECTIFIER  
VOLTAGE RANGE 50 to 600 Volts CURRENT 1.0 Ampere**

**FEATURES**

- \* Surge overload rating - 40 amperes peak
- \* Ideal for printed circuit board
- \* Reliable low cost construction utilizing molded
- \* Glass passivated device
- \* Polarity symbols molded on body
- \* Mounting position: Any

**MECHANICAL DATA**

- \* Epoxy: Device has UL flammability classification 94V-O



DB-S

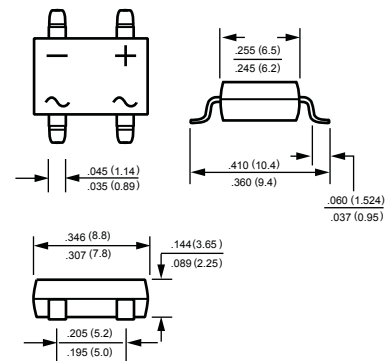

**MAXIMUM RATINGS AND ELECTRICAL CHARACTERISTICS**

Ratings at 25 °C ambient temperature unless otherwise specified.  
Resistive or inductive load.

**MAXIMUM RATINGS** (At  $T_A = 25^\circ\text{C}$  unless otherwise noted)

RATINGS	SYMBOL	EDB101S	EDB102S	EDB103S	EDB104S	EDB105S	EDB106S	EDB107S	UNITS
Maximum Recurrent Peak Reverse Voltage	$V_{RRM}$	50	100	150	200	300	400	600	Volts
Maximum RMS Bridge Input Voltage	$V_{RMS}$	35	70	105	140	210	280	420	Volts
Maximum DC Blocking Voltage	$V_{DC}$	50	100	150	200	300	400	600	Volts
Maximum Average Forward Output Current at $T_A = 55^\circ\text{C}$	$I_O$	1.0							Amps
Peak Forward Surge Current 8.3 ms single half sine-wave superimposed on rated load (JEDEC method)	$I_{FSM}$	30							Amps
Typical Current Square Time	$I^2T$	3.7							$\text{A}^2\text{S}$
	$R_{\theta JA}$	38							$^\circ\text{C}/\text{W}$
Typical Thermal Resistance (Note 3)	$R_{\theta JL}$	12							
	Typical Junction Capacitance (Note 2)	$C_J$	15			10			pF
Operating and Storage Temperature Range	$T_J, T_{STG}$	-55 to + 150							$^\circ\text{C}$

**ELECTRICAL CHARACTERISTICS** (At  $T_A = 25^\circ\text{C}$  unless otherwise noted)

CHARACTERISTICS	SYMBOL	EDB101S	EDB102S	EDB103S	EDB104S	EDB105S	EDB106S	EDB107S	UNITS
Maximum Forward Voltage at 1.0A DC	$V_F$	1.05			1.35			1.70	Volts
Maximum Reverse Current at Rated DC Blocking Voltage per element	$I_R$	@ $T_A = 25^\circ\text{C}$			5.0			$\mu\text{Amps}$	
		@ $T_A = 100^\circ\text{C}$			100			$\mu\text{Amps}$	
Maximum Reverse Recovery Time (Note 1)	$t_{rr}$	50							nSec

Note: 1. Test Conditions:  $I_F=0.5\text{A}, I_R=1.0\text{A}, I_{RR}=-0.25\text{A}$ .  
2. Measured at 1MHz and applied reverse voltage of 4.0 volts.  
3. Thermal Resistance : Mounted on PCB.

# RATING AND CHARACTERISTICS CURVES ( EDB101S THRU EDB107S )

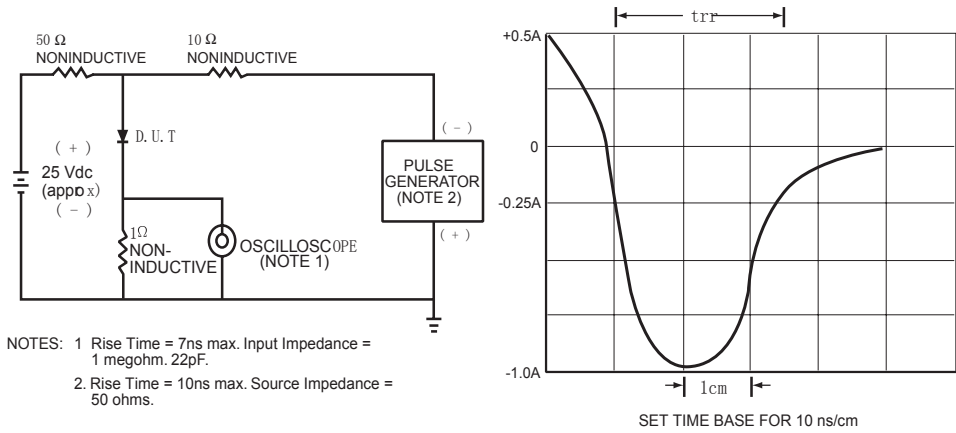

FIG.1 TEST CIRCUIT DIAGRAM AND REVERSE RECOVERY TIME CHARACTERISTIC

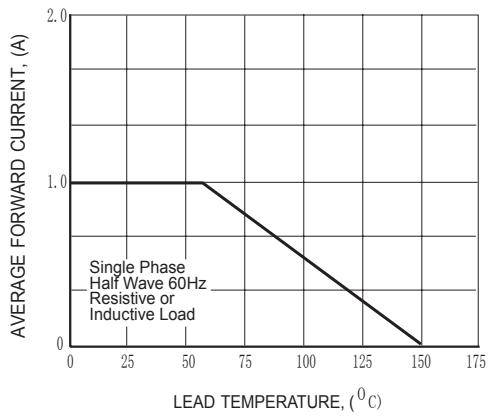

FIG.2 TYPICAL FORWARD CURRENT DERATING CURVE

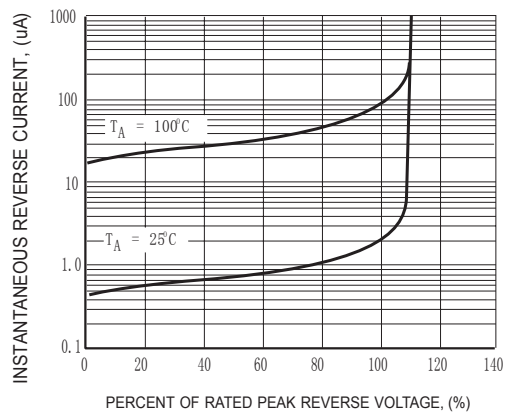

FIG.3 TYPICAL REVERSE CHARACTERISTICS

## RATING AND CHARACTERISTICS CURVES ( EDB101S THRU EDB107S )

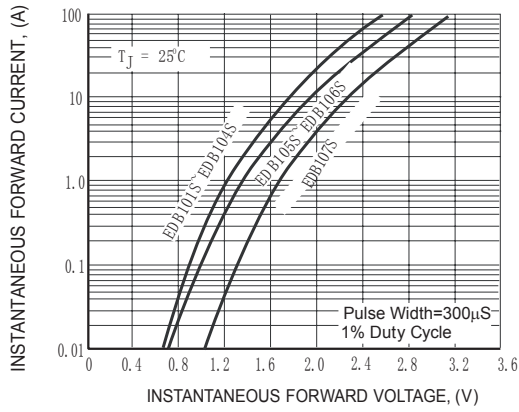

FIG. 4 TYPICAL INSTANTANEOUS FORWARD CHARACTERISTICS

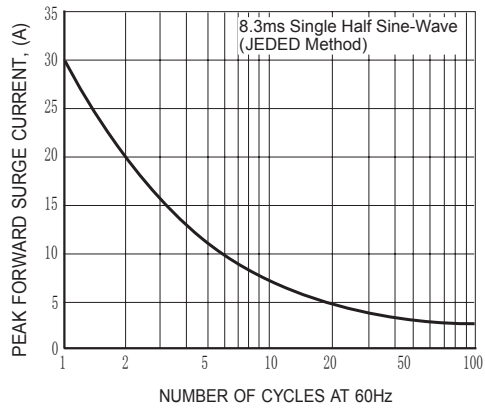

FIG. 5 MAXIMUM NON-REPETITIVE FORWARD SURGE CURRENT

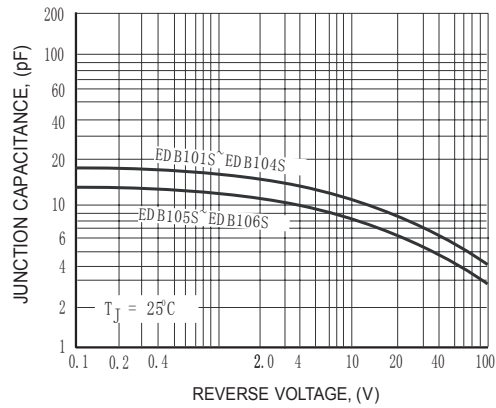

FIG. 6 TYPICAL JUNCTION CAPACITANCE



# RECTRON

## Attachment information about EDB10XS

### 1. Internal Circuit

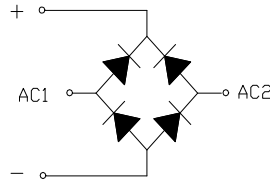

### 2. Marking on the body

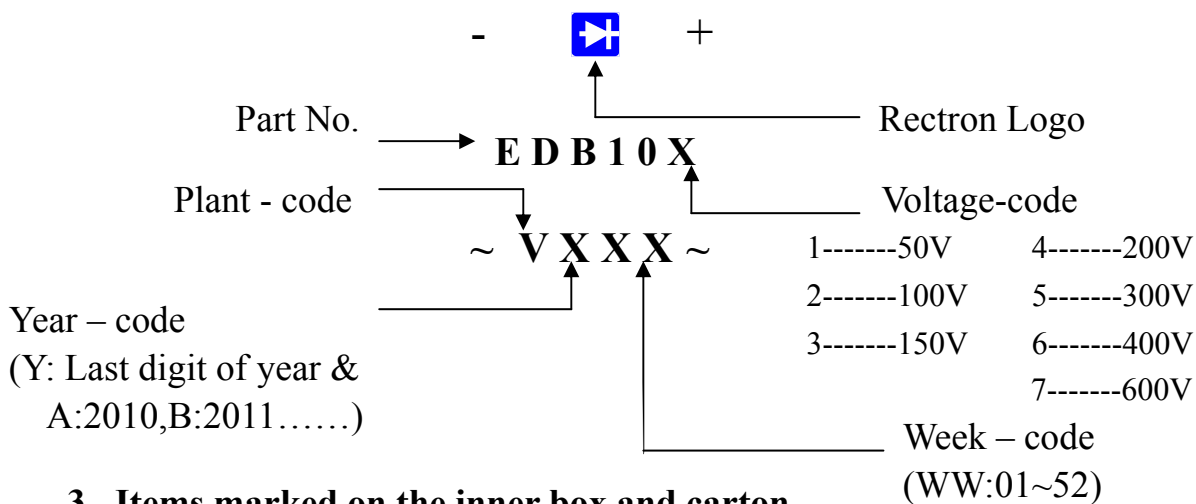

### 3. Items marked on the inner box and carton

#### 3.1 On the box (for -B)

**CUSTOMER**  
**TYPE**  
**LOT NO.**  
**QUANTITY**  
**Q.A.**  
**DATE**

#### 3.2 On the carton

**CUSTOMER**  
**TYPE**  
**QUANTITY**  
**LOT NO.**  
**REMARK**

## PACKAGING OF DIODE AND BRIDGE RECTIFIERS

### BULK PACK

PACKAGE	PACKING CODE	EA PER BOX	INNER BOX SIZE (mm)	CARTON SIZE (mm)	EA PER CARTON	WEIGHT(Kg)
DB-S	-C	4,000	450*140*84	464*305*283	24,000	18.44

### REEL PACK

PACKAGE	PACKING CODE	EA PER REEL	EA PER INNER BOX	COMPONENT SPACE (mm)	TAPE SPACE (mm)	REEL DIA (mm)	CARTON SIZE (mm)	EA PER CARTON	GROSS WEIGHT(Kg)
DB-S	-T/W	1,000	1,000	9.5	52	330	360*355*360	8,000	9.8