

Photomicrosensor (Transmissive) EE-SJ3 Series

⚠ Be sure to read Precautions on page 25.

■ Dimensions

Note: All units are in millimeters unless otherwise indicated.

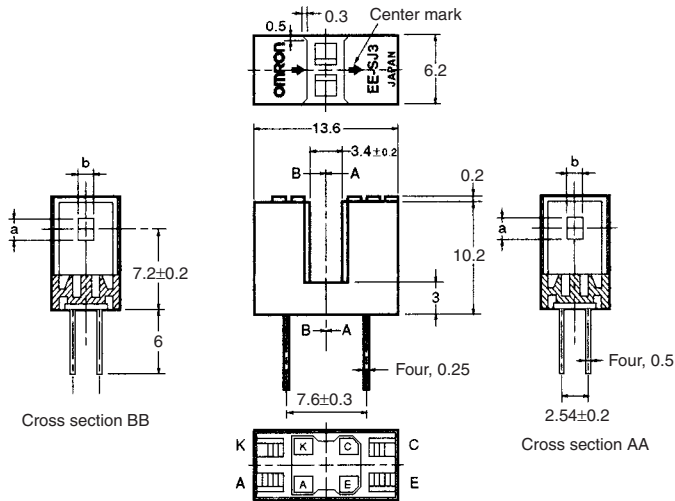

Model	Aperture (a x b)
EE-SJ3-C	2.1 x 1.0
EE-SJ3-D	2.1 x 0.2
EE-SJ3-G	0.5 x 2.1

Internal Circuit

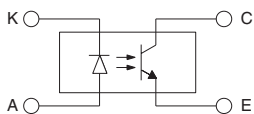

Unless otherwise specified, the tolerances are as shown below.

Dimensions	Tolerance
3 mm max.	±0.3
3 < mm ≤ 6	±0.375
6 < mm ≤ 10	±0.45
10 < mm ≤ 18	±0.55
18 < mm ≤ 30	±0.65

Terminal No.	Name
A	Anode
K	Cathode
C	Collector
E	Emitter

■ Features

- High-resolution model with a 0.2-mm-wide sensing aperture, high-sensitivity model with a 1-mm-wide sensing aperture, and model with a horizontal sensing aperture are available.

■ Absolute Maximum Ratings (Ta = 25°C)

Item	Symbol	Rated value
Emitter	Forward current	I_F 50 mA (see note 1)
	Pulse forward current	I_{FP} 1 A (see note 2)
	Reverse voltage	V_R 4 V
Detector	Collector-Emitter voltage	V_{CEO} 30 V
	Emitter-Collector voltage	V_{ECO} ---
	Collector current	I_C 20 mA
	Collector dissipation	P_C 100 mW (see note 1)
	Ambient temperature	Operating: T_{opr} -25°C to 85°C Storage: T_{stg} -30°C to 100°C
Soldering temperature	T_{sol} 260°C (see note 3)	

- Note:**
- Refer to the temperature rating chart if the ambient temperature exceeds 25°C.
 - The pulse width is 10 μs maximum with a frequency of 100 Hz.
 - Complete soldering within 10 seconds.

■ Electrical and Optical Characteristics (Ta = 25°C)

Item	Symbol	Value			Condition	
		EE-SJ3-C	EE-SJ3-D	EE-SJ3-G		
Emitter	Forward voltage	V_F	1.2 V typ., 1.5 V max.		$I_F = 30$ mA	
	Reverse current	I_R	0.01 μA typ., 10 μA max.		$V_R = 4$ V	
	Peak emission wavelength	λ_p	940 nm typ.		$I_F = 20$ mA	
Detector	Light current	I_L	1 to 28 mA typ.	0.1 mA min.	0.5 to 14 mA	$I_F = 20$ mA, $V_{CE} = 10$ V
	Dark current	I_D	2 nA typ., 200 nA max.			$V_{CE} = 10$ V, 0 lx
	Leakage current	I_{LEAK}	---			---
	Collector-Emitter saturated voltage	$V_{CE(sat)}$	0.1 V typ., 0.4 V max.	---	0.1 V typ., 0.4 V max.	$I_F = 20$ mA, $I_L = 0.1$ mA
	Peak spectral sensitivity wavelength	λ_p	850 nm typ.			$V_{CE} = 10$ V
Rising time	t_r	4 μs typ.			$V_{CC} = 5$ V, $R_L = 100$ Ω, $I_L = 5$ mA	
Falling time	t_f	4 μs typ.				

■ Engineering Data

Forward Current vs. Collector Dissipation Temperature Rating

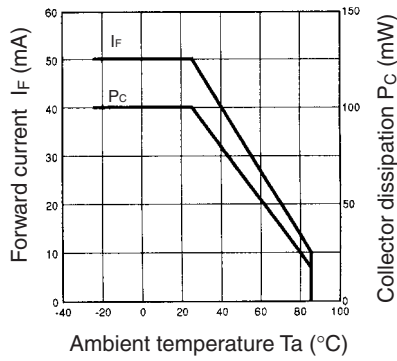

Forward Current vs. Forward Voltage Characteristics (Typical)

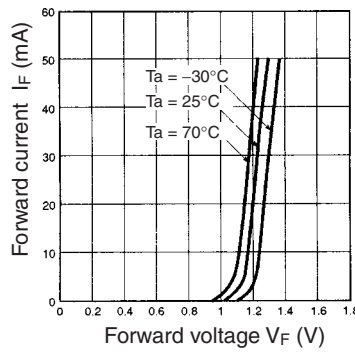

Light Current vs. Forward Current Characteristics (Typical)

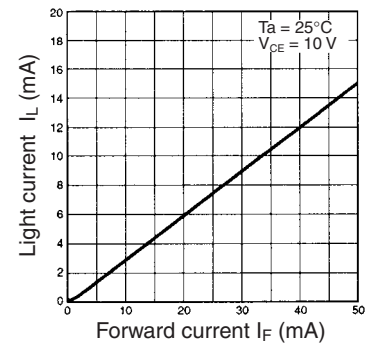

Light Current vs. Collector–Emitter Voltage Characteristics (EE-SJ3-G)

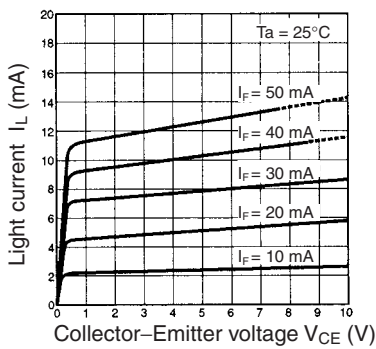

Relative Light Current vs. Ambient Temperature Characteristics (Typical)

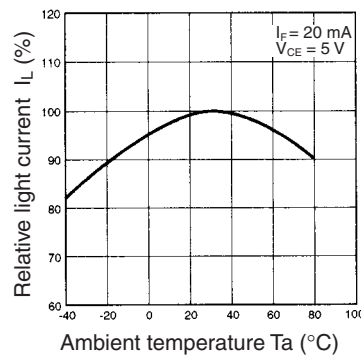

Dark Current vs. Ambient Temperature Characteristics (Typical)

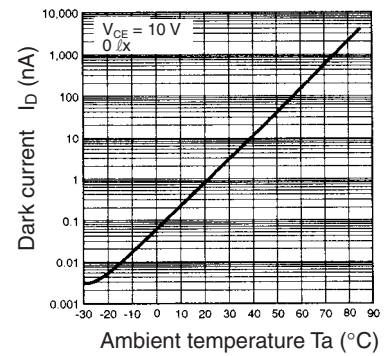

Response Time vs. Load Resistance Characteristics (Typical)

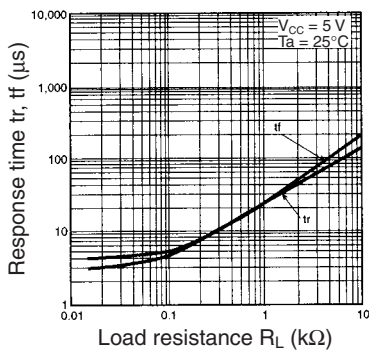

Sensing Position Characteristics (EE-SJ3-D)

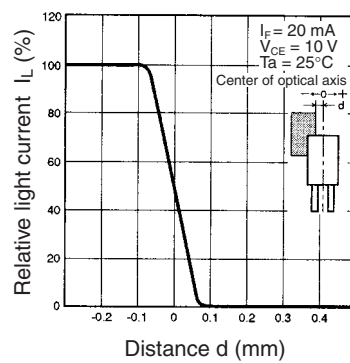

Sensing Position Characteristics (EE-SJ3-G)

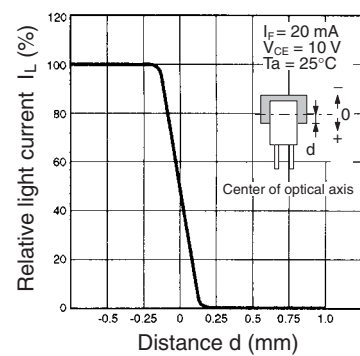

Sensing Position Characteristics (EE-SJ3-C)

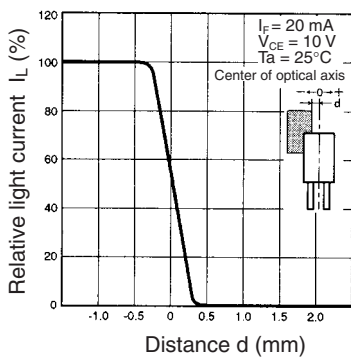

Response Time Measurement Circuit

