

EE-SX198/199/1018/1025/1041/1042/1070/1071

Miniature Transmissive
Photomicrosensor with 2- to 8-mm
Slot Width and Phototransistor
Output

- Stable sensing at temperatures as high as 95°C (EE-SX1041, EE-SX1070)
- Compact model with a 5-mm wide slot (EE-SX1041)
- Model with 12-mm deep and 5-mm wide slot (EE-SX1042)
- Miniature model with a 2-mm wide slot (EE-SX1018)
- Low-profile model (5.4 mm high) with a 2.8-mm slot width (EE-SX1025)

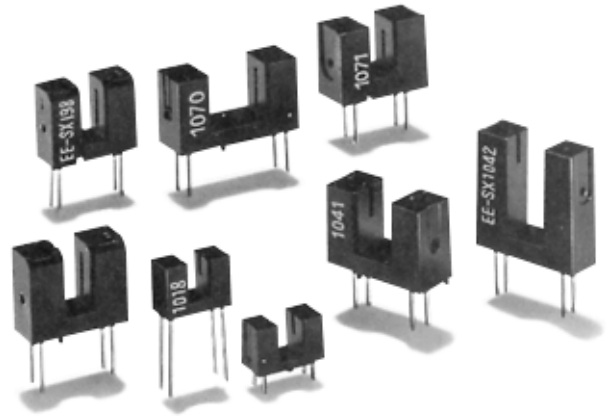

Ordering Information

| Appearance | Sensing method | Slot width | Slot depth | Sensing object | Output configuration | Weight | Part number |
|------------|----------------|------------|------------|---------------------------|----------------------|---------------|-------------|
| | Transmissive | 2 mm | 4.5 mm | Opaque, 0.5 x 1.5 mm min. | Phototransistor | Approx. 0.2 g | EE-SX1018 |
| | | 2.8 mm | 4.4 mm | | | | EE-SX1025 |
| | | 3 mm | 7.5 mm | Opaque, 0.5 x 2 mm min. | | Approx. 0.6 g | EE-SX198 |
| | | | | | | | EE-SX199 |
| | | | | | | | EE-SX1071 |
| | | 5 mm | 8.2 mm | Opaque, 0.5 x 2.2 mm min. | | Approx. 0.8 g | EE-SX1041 |
| | | 5 mm | 12 mm | Opaque, 0.5 x 2 mm min. | | | EE-SX1042 |
| | | 8 mm | 8.2 mm | Opaque, 0.5 x 2.2 mm min. | | Approx. 0.6 g | EE-SX1070 |

Specifications

■ ABSOLUTE MAXIMUM RATINGS (T_A = 25°C (77°F))

| Item | Symbol | Rated value |
|---------------------|---------------------------|---------------------------------------|
| Emitter | Forward current | I _F 50 mA* |
| | Reverse voltage | V _R 4 V |
| Detector | Collector-emitter voltage | V _{CEO} 30 V |
| | Collector current | I _C 20 mA |
| | Collector dissipation | P _C 100 mW* |
| Ambient temperature | Operating | Topr -25°C to 85°C (-13°F to 185°F)** |
| | Storage | Tstg -30°C to 100°C (-22°F to 212°F) |

*Refer to Engineering Data if the ambient temperature is not within the normal room temperature range.

**The operating temperature of the EE-SX1041/1070 is -25° to 95°C (-13°F to 203°F).

■ CHARACTERISTICS (T_A = 25°C (77°F))

| Item | Symbol | EE-SX1018/1025/1041/1042/1070/1071 | | EE-SX198/199 | |
|-------------|--------------------------------------|--|--|----------------------------|--|
| | | Value | Condition | Value | Condition |
| Emitter | Forward voltage | V _F 1.2 V typ. 1.5 V max. | I _F = 30 mA | 1.2 V typ. 1.4 V max. | I _F = 20 mA |
| | Reverse current | I _R 0.01 μA typ. 10 μA max. | V _R = 4 V | 0.01 μA typ. 10 μA max. | V _R = 4 V |
| | Peak emission wavelength | λ _{p(L)} 940 nm typ. | I _F = 20 mA | 940 nm typ. | I _F = 20 mA |
| Detector | Dark current | I _D 2 nA typ. 200 nA max. | V _{CE} = 10 V 0/x | 2 nA typ. 200 nA max. | V _{CE} = 10 V 0/x |
| | Peak spectral sensitivity wavelength | λ _{p(P)} 850 nm typ. | V _{CE} = 10 V | 850 nm typ. | V _{CE} = 10 V |
| Combination | Light current (collector current) | I _L 0.5 mA min. 14 mA max. | I _F = 20 mA V _{CE} = 10 V | 0.5 mA min. 14 mA max. | I _F = 20 mA V _{CE} = 5 V |
| | Collector-emitter saturated voltage | V _{CE (sat)} 0.1 V typ. 0.4 V max. | I _F = 20 mA I _L = 0.1 mA | 0.1 V typ. 0.4 V max. | I _F = 40 mA I _L = 0.5 mA |
| | Rising time (See Note.) | t _r 4 μs typ. | V _{CC} = 5 V R _L = 100 Ω I _L = 5 mA | 4 μs typ. | V _{CC} = 5 V R _L = 100 Ω I _L = 5 mA |
| | Falling time (See Note.) | t _f 4 μs typ. | | 4 μs typ. | |

Note: The following illustrations show the rising time, t_r, and the falling time, t_f.



Engineering Data

Note: The operating conditions of the photomicrosensor must be within the absolute maximum rating ranges.

■ TEMPERATURE CHARACTERISTICS

EE-SX198/199/1018/1025/1042/1071

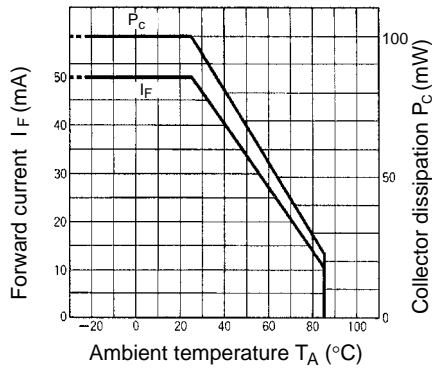

EE-SX1070/1041

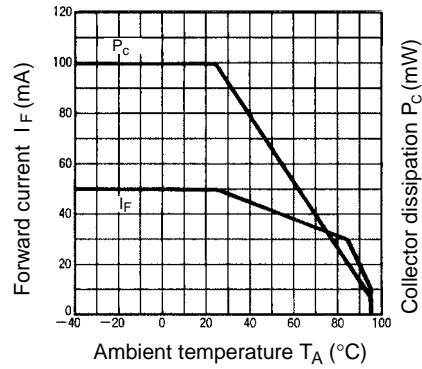

■ INPUT CHARACTERISTICS (TYPICAL)



■ DARK CURRENT TEMPERATURE DEPENDENCY (TYPICAL)



■ SWITCHING CHARACTERISTICS (TYPICAL)

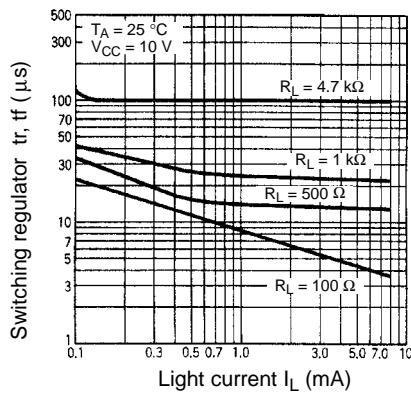

■ I/O CHARACTERISTIC (TYPICAL)

EE-SX1018/1025



EE-SX198/199



EE-SX1041/1042/1070/1071

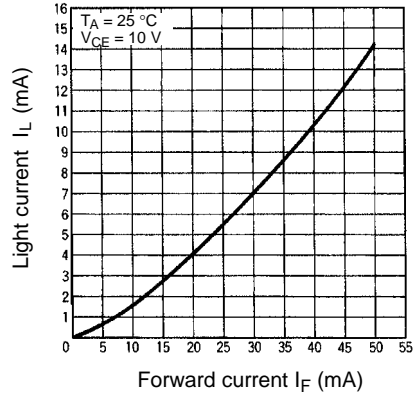

OUTPUT CHARACTERISTICS (TYPICAL)

EE-SX198/199/1041/1042/1070/1071



EE-SX1018/1025



LIGHT CURRENT TEMPERATURE DEPENDENCY (TYPICAL)

EE-SX198/199

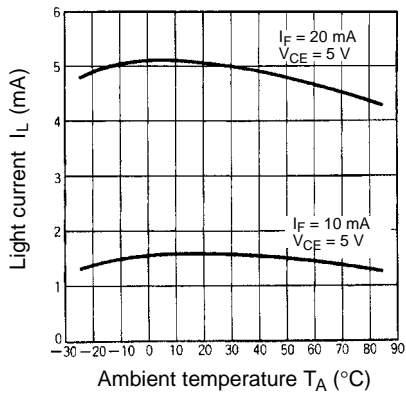

EE-SX1018/1025



EE-SX1041/1042/1070/1071



■ **SENSING POSITION CHARACTERISTICS (TYPICAL)**

EE-SX198/199



EE-SX1018



EE-SX1025



EE-SX1041



EE-SX1042

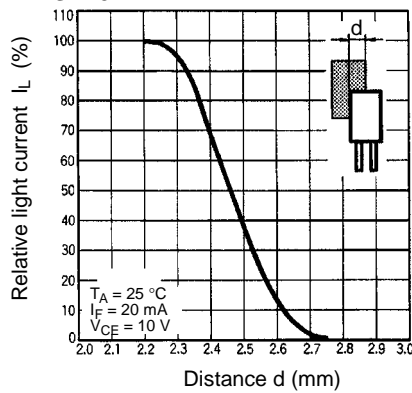

EE-SX1070/1071



Dimensions

Unit: mm (inch)

EE-SX198



EE-SX199



EE-SX1018



| Terminal No. | Name |
|--------------|-----------|
| A | Anode |
| K | Cathode |
| C | Collector |
| E | Emitter |

■ EE-SX1025

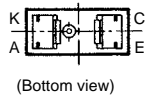

■ EE-SX1041

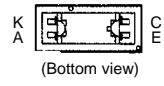
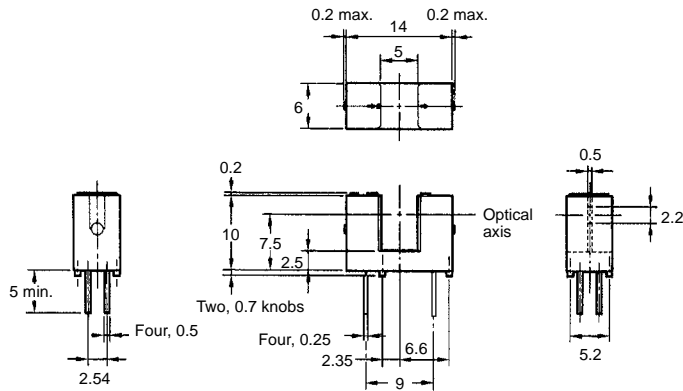

■ EE-SX1042

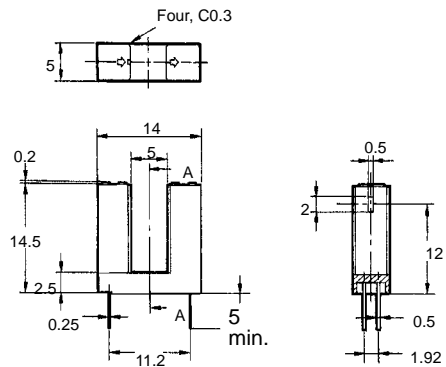

Cross section AA

