

Photomicrosensor (Transmissive)

EE-SX1031

Dual Channel Phototransistor Output Ideal for Encoder Applications

- High resolution (0.5 mm) sensing
- Separate LED/Phototransistor combinations within a single housing



⚠ Be sure to read *Safety Precautions* on page 3.

RoHS Compliant

Model Number Structure

EE-S X 1 031

(1) (2) (3) (4)

(1) Photomicrosensor (2) Transmissive (3) Phototransistor output (4) Serial number

Ordering Information

Photomicrosensor

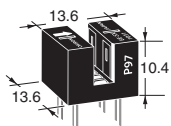
Appearance	Sensing method	Connecting method	Sensing distance	Aperture size (H × W) (mm)	Output type	Model	Minimum packing unit (Unit: pcs)
	Transmissive (slot type)	PCB mounting	3.4 mm (slot width)	Both emitting side and detecting side 2.1 × 0.5 2 ch	Phototransistor (Dual-channel output)	EE-SX1031	1

Note: Order in multiples of minimum packing unit.

Ratings, Characteristics and Exterior Specifications

Absolute Maximum Ratings (Ta = 25°C)

Item	Symbol	Rated value	Unit
Input			
Forward current	I _F	50 *1	mA
Pulse forward current	I _{FP}	---	A
Reverse voltage	V _R	4	V
Output			
Collector-Emitter voltage	V _{CEO}	30	V
Emitter-Collector voltage	V _{ECO}	---	V
Collector current	I _C	20	mA
Collector dissipation	P _C	100 *1	mW
Operating temperature	T _{opr}	-25 to 85	°C
Storage temperature	T _{stg}	-30 to 100	°C
Soldering temperature	T _{sol}	260 *2	°C

*1. Refer to the temperature rating chart if the ambient temperature exceeds 25°C.

*2. Complete soldering within 10 seconds.

Exterior Specifications

Connecting method	Weight (g)	Material
		Case
PCB mounting	1.47	Polycarbonate

Electrical and Optical Characteristics (Ta = 25°C)

Item	Symbol	Value			Unit	Condition
		MIN.	TYP.	MAX.		
Emitter						
Forward voltage	V _F	---	1.2	1.5	V	I _F = 30 mA
Reverse current	I _R	---	0.01	10	μA	V _R = 4 V
Peak emission wavelength	λ _{P(L)}	---	940	---	nm	I _F = 20 mA
Detector						
Dark current	I _D	---	2	200	nA	V _{CE} = 10 V, 0 lx
Peak spectral sensitivity wavelength	λ _{P(P)}	---	850	---	nm	V _{CE} = 10 V
Combination						
Light current (collector current)	I _L	0.5	---	14	mA	I _F = 20 mA, V _{CE} = 10 V
Collector-emitter saturated voltage	V _{CE (sat)}	---	0.15	0.4	V	I _F = 20 mA, I _L = 0.1 mA
Rising time	t _r	---	4	---	μs	V _{CC} = 5 V, R _L = 100 Ω, I _L = 5 mA
Falling time	t _f	---	4	---	μs	V _{CC} = 5 V, R _L = 100 Ω, I _L = 5 mA

Engineering Data (Reference value)

Fig 1. Forward Current vs. Collector Dissipation Temperature Rating

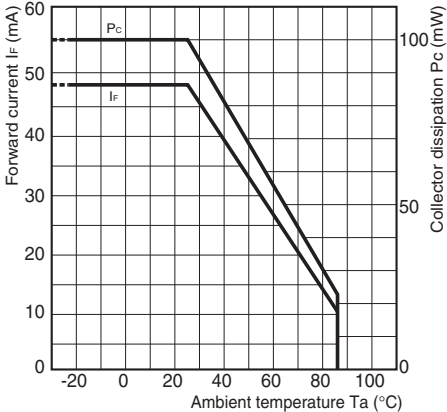

Fig 2. Forward Current vs. Forward Voltage Characteristics (Typical)

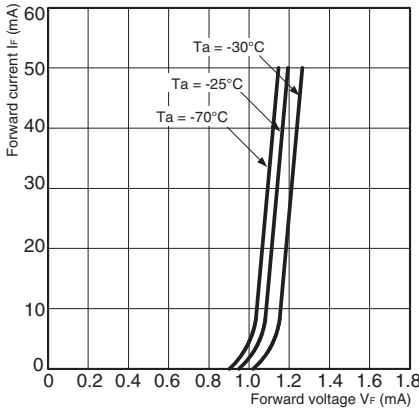

Fig 3. Light Current vs. Forward Current Characteristics (Typical)

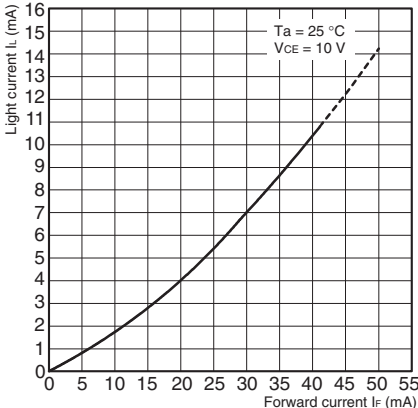

Fig 4. Light Current vs. Collector-Emitter Voltage Characteristics (Typical)

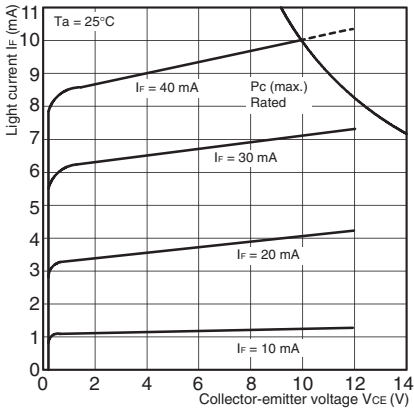

Fig 5. Relative Light Current vs. Ambient Temperature Characteristics (Typical)

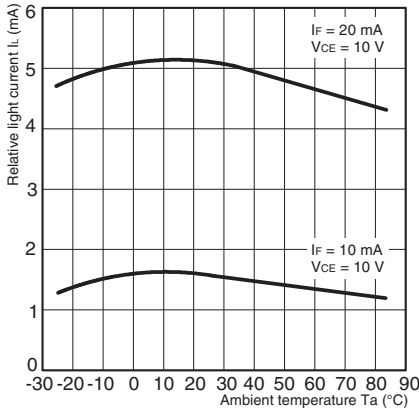

Fig 6. Dark Current vs. Ambient Temperature Characteristics (Typical)

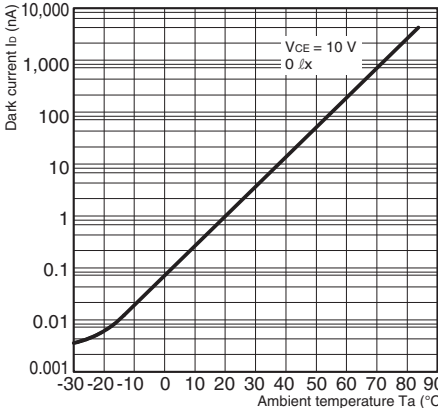

Fig 7. Response Time vs. Load Resistance Characteristics (Typical)

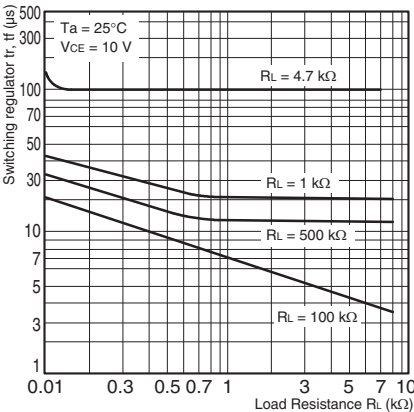

Fig 8. Sensing Position Characteristics (Typical)

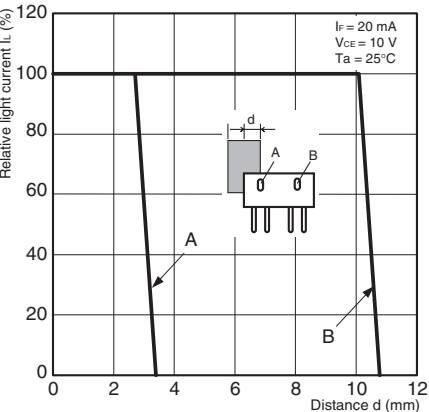
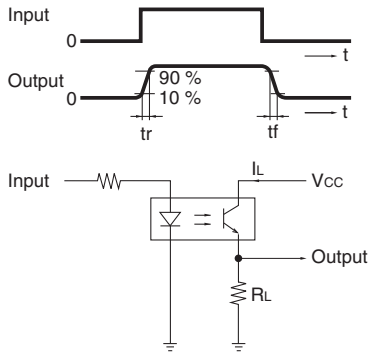

Fig 9. Response Time Measurement Circuit



Safety Precautions

To ensure safe operation, be sure to read and follow the Instruction Manual provided with the Sensor.

⚠ CAUTION

This product is not designed or rated for ensuring safety of persons either directly or indirectly. Do not use it for such purposes.

Precautions for Correct Use

Do not use the product in atmospheres or environments that exceed product ratings.

Precautions for Safe Use

Do not use the product with a voltage or current that exceeds the rated range.
 Applying a voltage or current that is higher than the rated range may result in explosion or fire.

Do not miswire such as the polarity of the power supply voltage.
 Otherwise the product may be damaged or it may burn.

This product does not resist water. Do not use the product in places where water or oil may be sprayed onto the product.

Dimensions and Internal Circuit

(Unit: mm)

Photomicrosensor

EE-SX1031



Aperture size (H × W)

Emitter	Detector
2.1 × 0.5 2ch	2.1 × 0.5 2ch

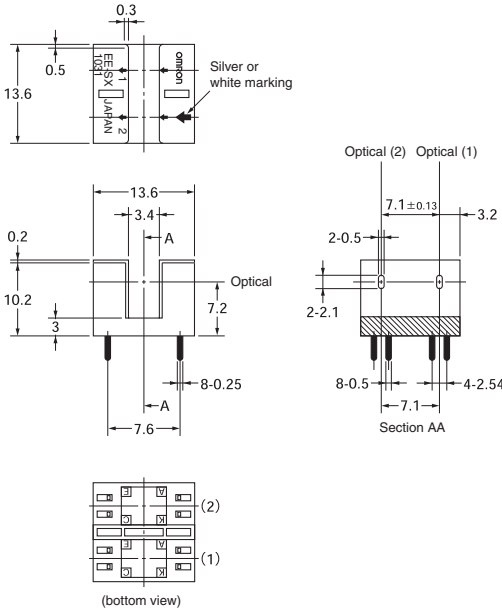

Unless otherwise specified, the tolerances are as shown below.

Dimensions	Tolerance
3 mm max.	±0.3
3 < mm ≤ 6	±0.375
6 < mm ≤ 10	±0.45
10 < mm ≤ 18	±0.55
18 < mm ≤ 30	±0.65

Internal circuit

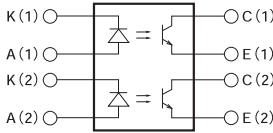

Terminal No.	Name
A	Anode
K	Cathode
C	Collector
E	Emitter