

EFM32 Giant Gecko Series 1 Family

EFM32GG11 Family Data Sheet



The EFM32 Giant Gecko Series 1 MCUs are the world's most energy-friendly microcontrollers, featuring new connectivity interfaces and user interface features.

EFM32GG11 includes a powerful 32-bit ARM® Cortex®-M4 and provides robust security via a unique cryptographic hardware engine supporting AES, ECC, SHA, and True Random Number Generator (TRNG). New features include an SD/MMC/SDIO controller, Octal/Quad-SPI memory controller, 10/100 Ethernet MAC, CAN bus controller, highly robust capacitive sensing, enhanced alpha blending graphics engine, and LESENSE/PCNT enhancements for smart energy meters. These features, combined with ultra-low current active mode and short wake-up time from energy-saving modes, make EFM32GG11 microcontrollers well suited for any battery-powered application, as well as other systems requiring high performance and low-energy consumption.

Example applications:

- Smart energy meters
- Industrial and factory automation
- Home automation and security
- Mid- and high-tier wearables
- IoT devices

- ARM Cortex-M4 at 72 MHz
- Ultra low energy operation
 - 80 µA/MHz in Energy Mode 0 (EM0)
 - 2.1 µA EM2 Deep Sleep current (RTCC running with state and RAM retention)
- Octal/Quad-SPI memory interface w/ XIP
- SD/MMC/SDIO Host Controller
- 10/100 Ethernet MAC with 802.3az EEE, IEEE1588
- Dual CAN 2.0 Bus Controller
- Crystal-free low-energy USB
- Hardware cryptographic engine supports AES, ECC, SHA, and TRNG
- Robust capacitive touch sense
- Footprint compatible with select EFM32 packages
- 5 V tolerant I/O

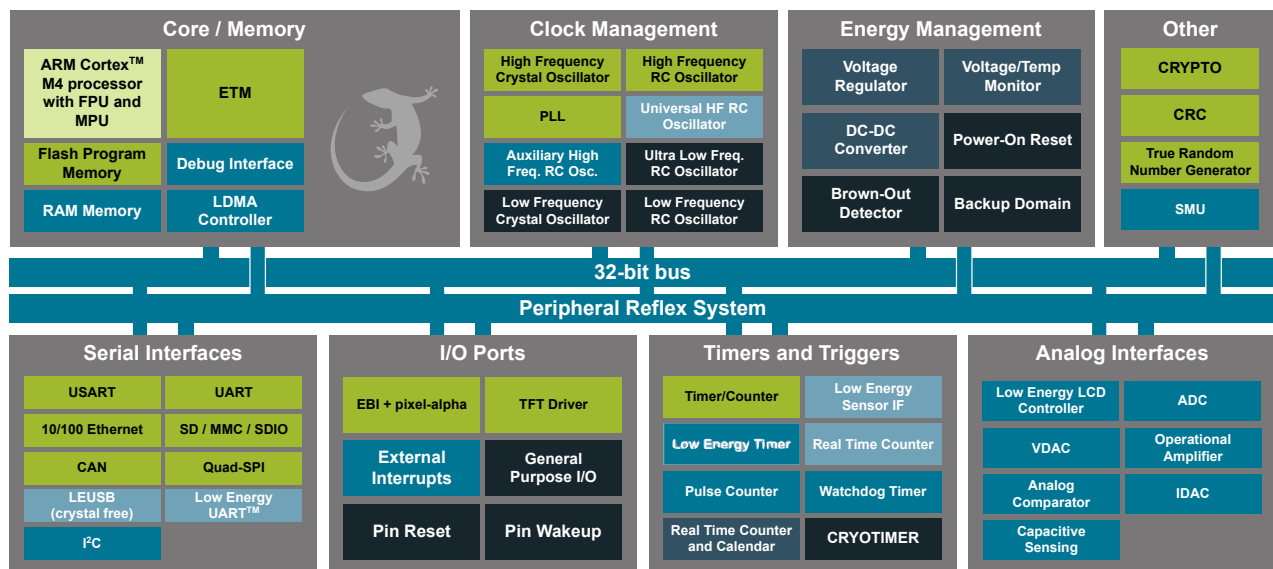

Lowest power mode with peripheral operational:

- EM0 - Active
- EM1 - Sleep
- EM2 - Deep Sleep
- EM3 - Stop
- EM4H - Hibernate
- EM4S - Shutoff

1. Feature List

The EFM32GG11 highlighted features are listed below.

- **ARM Cortex-M4 CPU platform**
 - High performance 32-bit processor @ up to 72 MHz
 - DSP instruction support and Floating Point Unit
 - Memory Protection Unit
 - Wake-up Interrupt Controller
- **Flexible Energy Management System**
 - 80 μ A/MHz in Active Mode (EM0)
 - 2.1 μ A EM2 Deep Sleep current (16 kB RAM retention and RTCC running from LFRCO)
- **Integrated DC-DC buck converter**
- **Up to 2048 kB flash program memory**
 - Dual-bank with read-while-write support
- **Up to 512 kB RAM data memory**
 - 256 kB with ECC (SEC-DED)
- **Octal/Quad-SPI Flash Memory Interface**
 - Supports 3 V and 1.8 V memories
 - 1/2/4/8-bit data bus
 - Quad-SPI Execute In Place (XIP)
- **Communication Interfaces**
 - Low-energy Universal Serial Bus (USB) with Device and Host support
 - Fully USB 2.0 compliant
 - On-chip PHY and embedded 5V to 3.3V regulator
 - Crystal-free Device mode operation
 - Patent-pending Low-Energy Mode (LEM)
 - SD/MMC/SDIO Host Controller
 - SD v3.01, SDIO v3.0 and MMC v4.51
 - 1/4/8-bit bus width
 - 10/100 Ethernet MAC with MII/RMII interface
 - IEEE1588-2008 precision time stamping
 - Energy Efficient Ethernet (802.3az)
 - Up to 2 \times CAN Bus Controller
 - Version 2.0A and 2.0B up to 1 Mbps
 - 6 \times Universal Synchronous/Asynchronous Receiver/ Transmitter
 - UART/SPI/SmartCard (ISO 7816)/IrDA/I2S/LIN
 - Triple buffered full/half-duplex operation with flow control
 - Ultra high speed (36 MHz) operation on one instance
 - 2 \times Universal Asynchronous Receiver/ Transmitter
 - 2 \times Low Energy UART
 - Autonomous operation with DMA in Deep Sleep Mode
 - 3 \times I²C Interface with SMBus support
 - Address recognition in EM3 Stop Mode
- **Up to 144 General Purpose I/O Pins**
 - Configurable push-pull, open-drain, pull-up/down, input filter, drive strength
 - Configurable peripheral I/O locations
 - 5 V tolerance on select pins
 - Asynchronous external interrupts
 - Output state retention and wake-up from Shutoff Mode
- **Up to 24 Channel DMA Controller**
- **Up to 24 Channel Peripheral Reflex System (PRS) for autonomous inter-peripheral signaling**
- **External Bus Interface for up to 4x256 MB of external memory mapped space**
 - TFT Controller with Direct Drive
 - Per-pixel alpha-blending engine
- **Hardware Cryptography**
 - AES 128/256-bit keys
 - ECC B/K163, B/K233, P192, P224, P256
 - SHA-1 and SHA-2 (SHA-224 and SHA-256)
 - True Random Number Generator (TRNG)
- **Hardware CRC engine**
 - Single-cycle computation with 8/16/32-bit data and 16-bit (programmable)/32-bit (fixed) polynomial
- **Security Management Unit (SMU)**
 - Fine-grained access control for on-chip peripherals
- **Integrated Low-energy LCD Controller with up to 8 \times 36 segments**
 - Voltage boost, contrast and autonomous animation
 - Patented low-energy LCD driver
- **Backup Power Domain**
 - RTCC and retention registers in a separate power domain, available down to energy mode EM4H
 - Operation from backup battery when main power absent/insufficient
- **Ultra Low-Power Precision Analog Peripherals**
 - 2 \times 12-bit 1 Msamples/s Analog to Digital Converter (ADC)
 - On-chip temperature sensor
 - 2 \times 12-bit 500 ksamples/s Digital to Analog Converter (VDAC)
 - Digital to Analog Current Converter (IDAC)
 - Up to 4 \times Analog Comparator (ACMP)
 - Up to 4 \times Operational Amplifier (OPAMP)
 - Robust current-based capacitive sensing with up to 64 inputs and wake-on-touch (CSEN)
 - Up to 108 GPIO pins are analog-capable. Flexible analog peripheral-to-pin routing via Analog Port (APORT)
 - Supply Voltage Monitor

- **Timers/Counters**
 - 7× 16-bit Timer/Counter
 - 3 + 4 Compare/Capture/PWM channels (4 + 4 on one timer instance)
 - Dead-Time Insertion on several timer instances
 - 4× 32-bit Timer/Counter
 - 32-bit Real Time Counter and Calendar (RTCC)
 - 24-bit Real Time Counter (RTC)
 - 32-bit Ultra Low Energy CRYOTIMER for periodic wakeup from any Energy Mode
 - 2× 16-bit Low Energy Timer for waveform generation
 - 3× 16-bit Pulse Counter with asynchronous operation
 - 2× Watchdog Timer with dedicated RC oscillator
- **Low Energy Sensor Interface (LESENSE)**
 - Autonomous sensor monitoring in Deep Sleep Mode
 - Wide range of sensors supported, including LC sensors and capacitive buttons
 - Up to 16 inputs
- **Ultra efficient Power-on Reset and Brown-Out Detector**
- **Debug Interface**
 - 2-pin Serial Wire Debug interface
 - 1-pin Serial Wire Viewer
 - 4-pin JTAG interface
 - Embedded Trace Macrocell (ETM)
- **Pre-Programmed Bootloader**
- **Wide Operating Range**
 - 1.8 V to 3.8 V single power supply
 - Integrated DC-DC, down to 1.8 V output with up to 200 mA load current for system
 - Standard (-40 °C to 85 °C T_{AMB}) and Extended (-40 °C to 125 °C T_J) temperature grades available
- **Packages**
 - QFN64 (9x9 mm)
 - TQFP64 (10x10 mm)
 - TQFP100 (14x14 mm)
 - BGA112 (10x10 mm)
 - BGA120 (7x7 mm)
 - BGA152 (8x8 mm)
 - BGA192 (7x7mm)

2. Ordering Information

Table 2.1. Ordering Information

Ordering Code	Flash (kB)	RAM (kB)	DC-DC Converter	USB	Ethernet	QSPI	SDIO	LCD	GPIO	Package	Temp Range
EFM32GG11B820F2048GL192-B	2048	512	Yes	Yes	Yes	Yes	Yes	Yes	144	BGA192	-40 to +85°C
EFM32GG11B840F1024GL192-B	1024	512	Yes	Yes	Yes	Yes	Yes	Yes	144	BGA192	-40 to +85°C
EFM32GG11B820F2048GL152-B	2048	512	Yes	Yes	Yes	Yes	Yes	Yes	121	BGA152	-40 to +85°C
EFM32GG11B820F2048IL152-B	2048	512	Yes	Yes	Yes	Yes	Yes	Yes	121	BGA152	-40 to +125°C
EFM32GG11B840F1024GL152-B	1024	512	Yes	Yes	Yes	Yes	Yes	Yes	121	BGA152	-40 to +85°C
EFM32GG11B840F1024IL152-B	1024	512	Yes	Yes	Yes	Yes	Yes	Yes	121	BGA152	-40 to +125°C
EFM32GG11B820F2048GL120-B	2048	512	Yes	Yes	Yes	Yes	Yes	Yes	95	BGA120	-40 to +85°C
EFM32GG11B820F2048IL120-B	2048	512	Yes	Yes	Yes	Yes	Yes	Yes	95	BGA120	-40 to +125°C
EFM32GG11B840F1024GL120-B	1024	512	Yes	Yes	Yes	Yes	Yes	Yes	95	BGA120	-40 to +85°C
EFM32GG11B840F1024IL120-B	1024	512	Yes	Yes	Yes	Yes	Yes	Yes	95	BGA120	-40 to +125°C
EFM32GG11B820F2048GQ100-B	2048	512	Yes	Yes	Yes	Yes	Yes	Yes	80	QFP100	-40 to +85°C
EFM32GG11B820F2048IQ100-B	2048	512	Yes	Yes	Yes	Yes	Yes	Yes	80	QFP100	-40 to +125°C
EFM32GG11B840F1024GQ100-B	1024	512	Yes	Yes	Yes	Yes	Yes	Yes	80	QFP100	-40 to +85°C
EFM32GG11B840F1024IQ100-B	1024	512	Yes	Yes	Yes	Yes	Yes	Yes	80	QFP100	-40 to +125°C
EFM32GG11B820F2048GQ64-B	2048	512	Yes	Yes	Yes	Yes	Yes	Yes	47	QFP64	-40 to +85°C
EFM32GG11B820F2048GM64-B	2048	512	Yes	Yes	Yes	Yes	Yes	Yes	50	QFN64	-40 to +85°C
EFM32GG11B820F2048IQ64-B	2048	512	Yes	Yes	Yes	Yes	Yes	Yes	47	QFP64	-40 to +125°C
EFM32GG11B820F2048IM64-B	2048	512	Yes	Yes	Yes	Yes	Yes	Yes	50	QFN64	-40 to +125°C
EFM32GG11B840F1024GQ64-B	1024	512	Yes	Yes	Yes	Yes	Yes	Yes	47	QFP64	-40 to +85°C
EFM32GG11B840F1024GM64-B	1024	512	Yes	Yes	Yes	Yes	Yes	Yes	50	QFN64	-40 to +85°C
EFM32GG11B840F1024IQ64-B	1024	512	Yes	Yes	Yes	Yes	Yes	Yes	47	QFP64	-40 to +125°C
EFM32GG11B840F1024IM64-B	1024	512	Yes	Yes	Yes	Yes	Yes	Yes	50	QFN64	-40 to +125°C
EFM32GG11B520F2048GL120-B	2048	512	Yes	No	No	No	No	Yes	95	BGA120	-40 to +85°C
EFM32GG11B510F2048GL120-B	2048	384	Yes	No	No	No	No	Yes	95	BGA120	-40 to +85°C
EFM32GG11B520F2048IL120-B	2048	512	Yes	No	No	No	No	Yes	95	BGA120	-40 to +125°C
EFM32GG11B510F2048IL120-B	2048	384	Yes	No	No	No	No	Yes	95	BGA120	-40 to +125°C
EFM32GG11B520F2048GQ100-B	2048	512	Yes	No	No	No	No	Yes	83	QFP100	-40 to +85°C
EFM32GG11B510F2048GQ100-B	2048	384	Yes	No	No	No	No	Yes	83	QFP100	-40 to +85°C
EFM32GG11B520F2048IQ100-B	2048	512	Yes	No	No	No	No	Yes	83	QFP100	-40 to +125°C
EFM32GG11B510F2048IQ100-B	2048	384	Yes	No	No	No	No	Yes	83	QFP100	-40 to +125°C

Ordering Code	Flash (kB)	RAM (kB)	DC-DC Converter	USB	Ethernet	QSPI	SDIO	LCD	GPIO	Package	Temp Range
EFM32GG11B520F2048GQ64-B	2048	512	Yes	No	No	No	No	Yes	50	QFP64	-40 to +85°C
EFM32GG11B510F2048GQ64-B	2048	384	Yes	No	No	No	No	Yes	50	QFP64	-40 to +85°C
EFM32GG11B520F2048GM64-B	2048	512	Yes	No	No	No	No	Yes	53	QFN64	-40 to +85°C
EFM32GG11B510F2048GM64-B	2048	384	Yes	No	No	No	No	Yes	53	QFN64	-40 to +85°C
EFM32GG11B520F2048IQ64-B	2048	512	Yes	No	No	No	No	Yes	50	QFP64	-40 to +125°C
EFM32GG11B510F2048IQ64-B	2048	384	Yes	No	No	No	No	Yes	50	QFP64	-40 to +125°C
EFM32GG11B520F2048IM64-B	2048	512	Yes	No	No	No	No	Yes	53	QFN64	-40 to +125°C
EFM32GG11B510F2048IM64-B	2048	384	Yes	No	No	No	No	Yes	53	QFN64	-40 to +125°C
EFM32GG11B420F2048GL120-B	2048	512	No	Yes	Yes	Yes	Yes	Yes	93	BGA120	-40 to +85°C
EFM32GG11B420F2048IL120-B	2048	512	No	Yes	Yes	Yes	Yes	Yes	93	BGA120	-40 to +125°C
EFM32GG11B420F2048GL112-B	2048	512	No	Yes	Yes	Yes	Yes	Yes	87	BGA112	-40 to +85°C
EFM32GG11B420F2048IL112-B	2048	512	No	Yes	Yes	Yes	Yes	Yes	87	BGA112	-40 to +125°C
EFM32GG11B420F2048GQ100-B	2048	512	No	Yes	Yes	Yes	Yes	Yes	83	QFP100	-40 to +85°C
EFM32GG11B420F2048IQ100-B	2048	512	No	Yes	Yes	Yes	Yes	Yes	83	QFP100	-40 to +125°C
EFM32GG11B420F2048GQ64-B	2048	512	No	Yes	Yes	Yes	Yes	Yes	50	QFP64	-40 to +85°C
EFM32GG11B420F2048GM64-B	2048	512	No	Yes	Yes	Yes	Yes	Yes	53	QFN64	-40 to +85°C
EFM32GG11B420F2048IQ64-B	2048	512	No	Yes	Yes	Yes	Yes	Yes	50	QFP64	-40 to +125°C
EFM32GG11B420F2048IM64-B	2048	512	No	Yes	Yes	Yes	Yes	Yes	53	QFN64	-40 to +125°C
EFM32GG11B320F2048GL112-B	2048	512	No	No	No	No	No	Yes	90	BGA112	-40 to +85°C
EFM32GG11B310F2048GL112-B	2048	384	No	No	No	No	No	Yes	90	BGA112	-40 to +85°C
EFM32GG11B320F2048GQ100-B	2048	512	No	No	No	No	No	Yes	86	QFP100	-40 to +85°C
EFM32GG11B310F2048GQ100-B	2048	384	No	No	No	No	No	Yes	86	QFP100	-40 to +85°C
EFM32GG11B120F2048GQ64-B	2048	512	No	No	No	No	No	No	53	QFP64	-40 to +85°C
EFM32GG11B110F2048GQ64-B	2048	384	No	No	No	No	No	No	53	QFP64	-40 to +85°C
EFM32GG11B120F2048GM64-B	2048	512	No	No	No	No	No	No	56	QFN64	-40 to +85°C
EFM32GG11B110F2048GM64-B	2048	384	No	No	No	No	No	No	56	QFN64	-40 to +85°C
EFM32GG11B120F2048IQ64-B	2048	512	No	No	No	No	No	No	53	QFP64	-40 to +125°C
EFM32GG11B110F2048IQ64-B	2048	384	No	No	No	No	No	No	53	QFP64	-40 to +125°C
EFM32GG11B120F2048IM64-B	2048	512	No	No	No	No	No	No	56	QFN64	-40 to +125°C
EFM32GG11B110F2048IM64-B	2048	384	No	No	No	No	No	No	56	QFN64	-40 to +125°C



Figure 2.1. Ordering Code Key

Table of Contents

1. Feature List	2
2. Ordering Information	4
3. System Overview	11
3.1 Introduction	11
3.2 Power	12
3.2.1 Energy Management Unit (EMU)	12
3.2.2 DC-DC Converter	12
3.2.3 5 V Regulator	12
3.2.4 EM2 and EM3 Power Domains	13
3.3 General Purpose Input/Output (GPIO)	13
3.4 Clocking	13
3.4.1 Clock Management Unit (CMU)	13
3.4.2 Internal and External Oscillators	14
3.5 Counters/Timers and PWM	14
3.5.1 Timer/Counter (TIMER)	14
3.5.2 Wide Timer/Counter (WTIMER)	14
3.5.3 Real Time Counter and Calendar (RTCC)	14
3.5.4 Low Energy Timer (LETIMER)	14
3.5.5 Ultra Low Power Wake-up Timer (CRYOTIMER)	14
3.5.6 Pulse Counter (PCNT)	15
3.5.7 Watchdog Timer (WDOG)	15
3.6 Communications and Other Digital Peripherals	15
3.6.1 Universal Synchronous/Asynchronous Receiver/Transmitter (USART)	15
3.6.2 Universal Asynchronous Receiver/Transmitter (UART)	15
3.6.3 Low Energy Universal Asynchronous Receiver/Transmitter (LEUART)	15
3.6.4 Inter-Integrated Circuit Interface (I ² C)	15
3.6.5 External Bus Interface (EBI)	15
3.6.6 Quad-SPI Flash Controller (QSPI)	16
3.6.7 SDIO Host Controller (SDIO)	16
3.6.8 Universal Serial Bus (USB)	16
3.6.9 Ethernet (ETH)	16
3.6.10 Controller Area Network (CAN)	16
3.6.11 Peripheral Reflex System (PRS)	16
3.6.12 Low Energy Sensor Interface (LESENSE)	16
3.7 Security Features	17
3.7.1 General Purpose Cyclic Redundancy Check (GPCRC)	17
3.7.2 Crypto Accelerator (CRYPTO)	17
3.7.3 True Random Number Generator (TRNG)	17
3.7.4 Security Management Unit (SMU)	17
3.8 Analog	17
3.8.1 Analog Port (APORT)	17
3.8.2 Analog Comparator (ACMP)	17
3.8.3 Analog to Digital Converter (ADC)	17

3.8.4	Capacitive Sense (CSEN)	.18
3.8.5	Digital to Analog Current Converter (IDAC)	.18
3.8.6	Digital to Analog Converter (VDAC)	.18
3.8.7	Operational Amplifiers	.18
3.8.8	Liquid Crystal Display Driver (LCD)	.18
3.9	Reset Management Unit (RMU)	.18
3.10	Core and Memory	.18
3.10.1	Processor Core	.18
3.10.2	Memory System Controller (MSC)	.19
3.10.3	Linked Direct Memory Access Controller (LDMA)	.19
3.10.4	Bootloader	.19
3.11	Memory Map	.20
3.12	Configuration Summary	.22
4.	Electrical Specifications	.23
4.1	Electrical Characteristics	.23
4.1.1	Absolute Maximum Ratings	.24
4.1.2	Operating Conditions	.25
4.1.3	Thermal Characteristics	.27
4.1.4	DC-DC Converter	.28
4.1.5	5V Regulator	.30
4.1.6	Backup Supply Domain	.31
4.1.7	Current Consumption	.32
4.1.8	Wake Up Times	.39
4.1.9	Brown Out Detector (BOD)	.40
4.1.10	Oscillators	.41
4.1.11	Flash Memory Characteristics	.48
4.1.12	General-Purpose I/O (GPIO)	.49
4.1.13	Voltage Monitor (VMON)	.51
4.1.14	Analog to Digital Converter (ADC)	.52
4.1.15	Analog Comparator (ACMP)	.54
4.1.16	Digital to Analog Converter (VDAC)	.57
4.1.17	Current Digital to Analog Converter (IDAC)	.60
4.1.18	Capacitive Sense (CSEN)	.62
4.1.19	Operational Amplifier (OPAMP)	.64
4.1.20	LCD Driver	.67
4.1.21	Pulse Counter (PCNT)	.68
4.1.22	Analog Port (APORT)	.68
4.1.23	I2C	.69
4.1.24	USART SPI	.72
4.1.25	External Bus Interface (EBI)	.75
4.1.26	Ethernet (ETH)	.84
4.1.27	Serial Data I/O Host Controller (SDIO)	.87
4.1.28	Quad SPI (QSPI)	.105
4.2	Typical Performance Curves	.109
4.2.1	Supply Current	.110
4.2.2	DC-DC Converter	.116

5. Pin Definitions	118
5.1 EFM32GG11B8xx in BGA192 Device Pinout	118
5.2 EFM32GG11B8xx in BGA152 Device Pinout	122
5.3 EFM32GG11B8xx in BGA120 Device Pinout	126
5.4 EFM32GG11B5xx in BGA120 Device Pinout	129
5.5 EFM32GG11B4xx in BGA120 Device Pinout	132
5.6 EFM32GG11B4xx in BGA112 Device Pinout	135
5.7 EFM32GG11B3xx in BGA112 Device Pinout	138
5.8 EFM32GG11B8xx in QFP100 Device Pinout	141
5.9 EFM32GG11B5xx in QFP100 Device Pinout	144
5.10 EFM32GG11B4xx in QFP100 Device Pinout	147
5.11 EFM32GG11B3xx in QFP100 Device Pinout	150
5.12 EFM32GG11B8xx in QFP64 Device Pinout	153
5.13 EFM32GG11B5xx in QFP64 Device Pinout	155
5.14 EFM32GG11B4xx in QFP64 Device Pinout	157
5.15 EFM32GG11B1xx in QFP64 Device Pinout	159
5.16 EFM32GG11B8xx in QFN64 Device Pinout	161
5.17 EFM32GG11B5xx in QFN64 Device Pinout	163
5.18 EFM32GG11B4xx in QFN64 Device Pinout	165
5.19 EFM32GG11B1xx in QFN64 Device Pinout	167
5.20 GPIO Functionality Table	169
5.21 Alternate Functionality Overview	181
5.22 Analog Port (APORT) Client Maps	214
6. BGA192 Package Specifications	227
6.1 BGA192 Package Dimensions	227
6.2 BGA192 PCB Land Pattern	229
6.3 BGA192 Package Marking	231
7. BGA152 Package Specifications	232
7.1 BGA152 Package Dimensions	232
7.2 BGA152 PCB Land Pattern	234
7.3 BGA152 Package Marking	236
8. BGA120 Package Specifications	237
8.1 BGA120 Package Dimensions	237
8.2 BGA120 PCB Land Pattern	239
8.3 BGA120 Package Marking	241
9. BGA112 Package Specifications	242
9.1 BGA112 Package Dimensions	242

9.2 BGA112 PCB Land Pattern	244
9.3 BGA112 Package Marking	246
10. TQFP100 Package Specifications	247
10.1 TQFP100 Package Dimensions	247
10.2 TQFP100 PCB Land Pattern	249
10.3 TQFP100 Package Marking	250
11. TQFP64 Package Specifications	251
11.1 TQFP64 Package Dimensions	251
11.2 TQFP64 PCB Land Pattern	253
11.3 TQFP64 Package Marking	254
12. QFN64 Package Specifications	255
12.1 QFN64 Package Dimensions.	255
12.2 QFN64 PCB Land Pattern.	257
12.3 QFN64 Package Marking	259
13. Revision History.	260

3. System Overview

3.1 Introduction

The Giant Gecko Series 1 product family is well suited for any battery operated application as well as other systems requiring high performance and low energy consumption. This section gives a short introduction to the MCU system. The detailed functional description can be found in the Giant Gecko Series 1 Reference Manual.

A block diagram of the Giant Gecko Series 1 family is shown in [Figure 3.1 Detailed EFM32GG11 Block Diagram on page 11](#). The diagram shows a superset of features available on the family, which vary by OPN. For more information about specific device features, consult [Ordering Information](#).

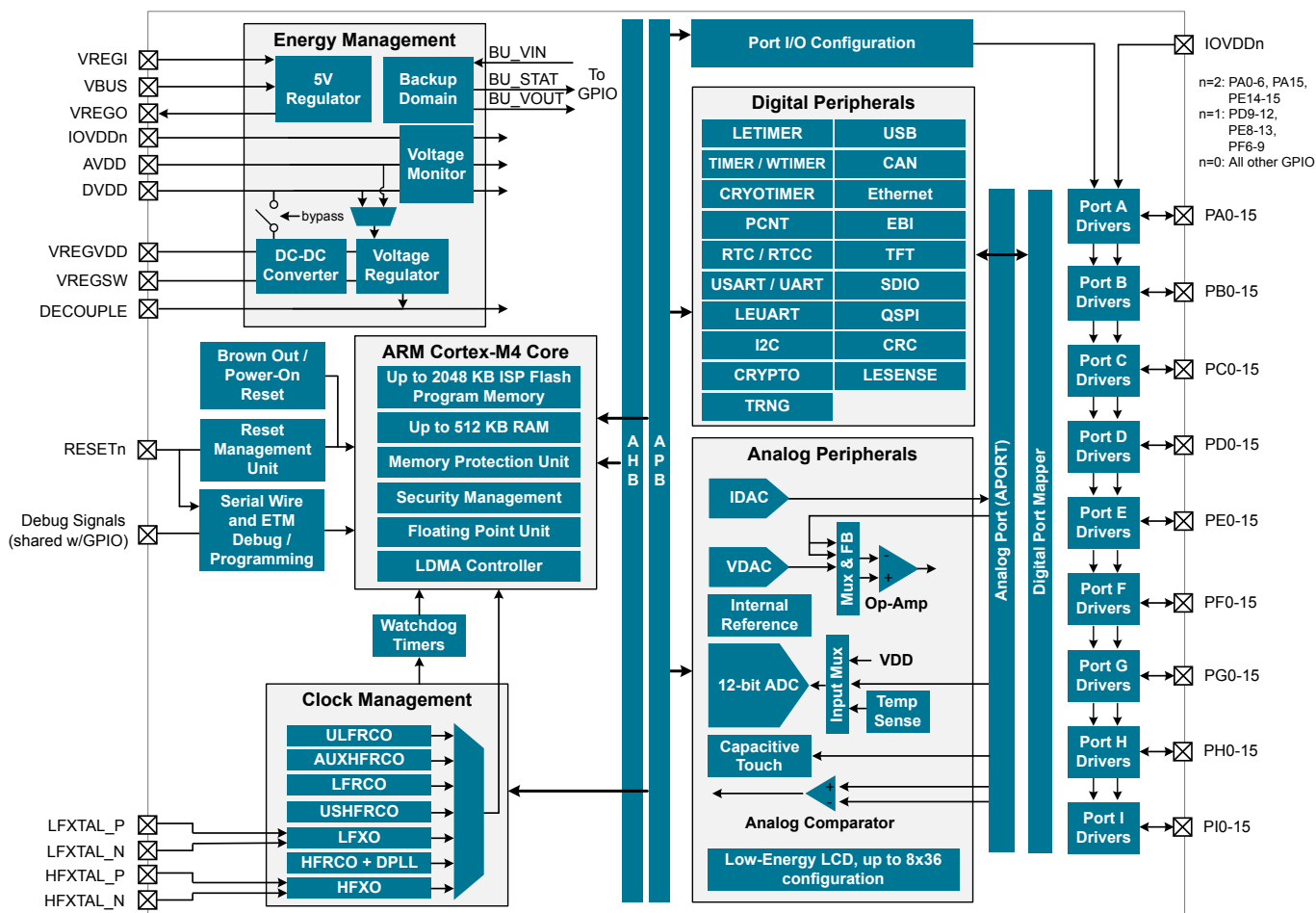

Figure 3.1. Detailed EFM32GG11 Block Diagram

3.2 Power

The EFM32GG11 has an Energy Management Unit (EMU) and efficient integrated regulators to generate internal supply voltages. Only a single external supply voltage is required, from which all internal voltages are created. A 5 V regulator is available on some OPNs, allowing the device to be powered directly from 5 V power sources, such as USB. An optional integrated DC-DC buck regulator can be utilized to further reduce the current consumption. The DC-DC regulator requires one external inductor and one external capacitor.

The EFM32GG11 device family includes support for internal supply voltage scaling, as well as two different power domain groups for peripherals. These enhancements allow for further supply current reductions and lower overall power consumption.

AVDD and VREGVDD need to be 1.8 V or higher for the MCU to operate across all conditions; however the rest of the system will operate down to 1.62 V, including the digital supply and I/O. This means that the device is fully compatible with 1.8 V components. Running from a sufficiently high supply, the device can use the DC-DC to regulate voltage not only for itself, but also for other PCB components, supplying up to a total of 200 mA.

3.2.1 Energy Management Unit (EMU)

The Energy Management Unit manages transitions of energy modes in the device. Each energy mode defines which peripherals and features are available and the amount of current the device consumes. The EMU can also be used to turn off the power to unused RAM blocks, and it contains control registers for the DC-DC regulator and the Voltage Monitor (VMON). The VMON is used to monitor multiple supply voltages. It has multiple channels which can be programmed individually by the user to determine if a sensed supply has fallen below a chosen threshold.

3.2.2 DC-DC Converter

The DC-DC buck converter covers a wide range of load currents and provides up to 90% efficiency in energy modes EM0, EM1, EM2 and EM3, and can supply up to 200 mA to the device and surrounding PCB components. Protection features include programmable current limiting, short-circuit protection, and dead-time protection. The DC-DC converter may also enter bypass mode when the input voltage is too low for efficient operation. In bypass mode, the DC-DC input supply is internally connected directly to its output through a low resistance switch. Bypass mode also supports in-rush current limiting to prevent input supply voltage droops due to excessive output current transients.

3.2.3 5 V Regulator

A 5 V input regulator is available, allowing the device to be powered directly from 5 V power sources such as the USB VBUS line. The regulator is available in all energy modes, and outputs 3.3 V to be used to power the USB PHY and other 3.3 V systems. Two inputs to the regulator allow for seamless switching between local and external power sources.

3.2.4 EM2 and EM3 Power Domains

The EFM32GG11 has three independent peripheral power domains for use in EM2 and EM3. Two of these domains are dynamic and can be shut down to save energy. Peripherals associated with the two dynamic power domains are listed in [Table 3.1 EM2 and EM3 Peripheral Power Subdomains](#) on page 13. If all of the peripherals in a peripheral power domain are unused, the power domain for that group will be powered off in EM2 and EM3, reducing the overall current consumption of the device. Other EM2, EM3, and EM4-capable peripherals and functions not listed in the table below reside on the primary power domain, which is always on in EM2 and EM3.

Table 3.1. EM2 and EM3 Peripheral Power Subdomains

Peripheral Power Domain 1	Peripheral Power Domain 2
ACMP0	ACMP1
PCNT0	PCNT1
ADC0	PCNT2
LETIMER0	CSEN
LESENSE	VDAC0
APOINT	LEUART0
-	LEUART1
-	LETIMER1
-	I2C0
-	I2C1
-	I2C2
-	IDAC
-	ADC1
-	ACMP2
-	ACMP3
-	LCD
-	RTC

3.3 General Purpose Input/Output (GPIO)

EFM32GG11 has up to 144 General Purpose Input/Output pins. GPIO are organized on three independent supply rails, allowing for interface to multiple logic levels in the system simultaneously. Each GPIO pin can be individually configured as either an output or input. More advanced configurations including open-drain, open-source, and glitch-filtering can be configured for each individual GPIO pin. The GPIO pins can be overridden by peripheral connections, like SPI communication. Each peripheral connection can be routed to several GPIO pins on the device. The input value of a GPIO pin can be routed through the Peripheral Reflex System to other peripherals. The GPIO subsystem supports asynchronous external pin interrupts.

3.4 Clocking

3.4.1 Clock Management Unit (CMU)

The Clock Management Unit controls oscillators and clocks in the EFM32GG11. Individual enabling and disabling of clocks to all peripherals is performed by the CMU. The CMU also controls enabling and configuration of the oscillators. A high degree of flexibility allows software to optimize energy consumption in any specific application by minimizing power dissipation in unused peripherals and oscillators.

3.4.2 Internal and External Oscillators

The EFM32GG11 supports two crystal oscillators and fully integrates five RC oscillators, listed below.

- A high frequency crystal oscillator (HFXO) with integrated load capacitors, tunable in small steps, provides a precise timing reference for the MCU. Crystal frequencies in the range from 4 to 50 MHz are supported. An external clock source such as a TCXO can also be applied to the HFXO input for improved accuracy over temperature.
- A 32.768 kHz crystal oscillator (LFXO) provides an accurate timing reference for low energy modes.
- An integrated high frequency RC oscillator (HFRCO) is available for the MCU system. The HFRCO employs fast startup at minimal energy consumption combined with a wide frequency range. When crystal accuracy is not required, it can be operated in free-running mode at a number of factory-calibrated frequencies. A digital phase-locked loop (DPLL) feature allows the HFRCO to achieve higher accuracy and stability by referencing other available clock sources such as LFXO and HFXO.
- An integrated auxiliary high frequency RC oscillator (AUXHFRCO) is available for timing the general-purpose ADC and the Serial Wire Viewer port with a wide frequency range.
- An integrated universal high frequency RC oscillator (USHFRCO) is available for timing the USB, SDIO and QSPI peripherals. The USHFRCO can be synchronized to the host's USB clock to allow the USB to operate in device mode without the additional cost of an external crystal.
- An integrated low frequency 32.768 kHz RC oscillator (LFRCO) can be used as a timing reference in low energy modes, when crystal accuracy is not required.
- An integrated ultra-low frequency 1 kHz RC oscillator (ULFRCO) is available to provide a timing reference at the lowest energy consumption in low energy modes.

3.5 Counters/Timers and PWM

3.5.1 Timer/Counter (TIMER)

TIMER peripherals keep track of timing, count events, generate PWM outputs and trigger timed actions in other peripherals through the PRS system. The core of each TIMER is a 16-bit counter with up to 4 compare/capture channels. Each channel is configurable in one of three modes. In capture mode, the counter state is stored in a buffer at a selected input event. In compare mode, the channel output reflects the comparison of the counter to a programmed threshold value. In PWM mode, the TIMER supports generation of pulse-width modulation (PWM) outputs of arbitrary waveforms defined by the sequence of values written to the compare registers, with optional dead-time insertion available in timer unit TIMER_0 only.

3.5.2 Wide Timer/Counter (WTIMER)

WTIMER peripherals function just as TIMER peripherals, but are 32 bits wide. They keep track of timing, count events, generate PWM outputs and trigger timed actions in other peripherals through the PRS system. The core of each WTIMER is a 32-bit counter with up to 4 compare/capture channels. Each channel is configurable in one of three modes. In capture mode, the counter state is stored in a buffer at a selected input event. In compare mode, the channel output reflects the comparison of the counter to a programmed threshold value. In PWM mode, the WTIMER supports generation of pulse-width modulation (PWM) outputs of arbitrary waveforms defined by the sequence of values written to the compare registers, with optional dead-time insertion available in timer unit WTIMER_0 only.

3.5.3 Real Time Counter and Calendar (RTCC)

The Real Time Counter and Calendar (RTCC) is a 32-bit counter providing timekeeping in all energy modes. The RTCC includes a Binary Coded Decimal (BCD) calendar mode for easy time and date keeping. The RTCC can be clocked by any of the on-board low-frequency oscillators, and it is capable of providing system wake-up at user defined instances. The RTCC includes 128 bytes of general purpose data retention, allowing easy and convenient data storage in all energy modes down to EM4H.

3.5.4 Low Energy Timer (LETIMER)

The unique LETIMER is a 16-bit timer that is available in energy mode EM0 Active, EM1 Sleep, EM2 Deep Sleep, and EM3 Stop. This allows it to be used for timing and output generation when most of the device is powered down, allowing simple tasks to be performed while the power consumption of the system is kept at an absolute minimum. The LETIMER can be used to output a variety of waveforms with minimal software intervention. The LETIMER is connected to the Real Time Counter and Calendar (RTCC), and can be configured to start counting on compare matches from the RTCC.

3.5.5 Ultra Low Power Wake-up Timer (CRYOTIMER)

The CRYOTIMER is a 32-bit counter that is capable of running in all energy modes. It can be clocked by either the 32.768 kHz crystal oscillator (LFXO), the 32.768 kHz RC oscillator (LFRCO), or the 1 kHz RC oscillator (ULFRCO). It can provide periodic Wakeup events and PRS signals which can be used to wake up peripherals from any energy mode. The CRYOTIMER provides a wide range of interrupt periods, facilitating flexible ultra-low energy operation.

3.5.6 Pulse Counter (PCNT)

The Pulse Counter (PCNT) peripheral can be used for counting pulses on a single input or to decode quadrature encoded inputs. The clock for PCNT is selectable from either an external source on pin PCTNn_S0IN or from an internal timing reference, selectable from among any of the internal oscillators, except the AUXHFRCO. The peripheral may operate in energy mode EM0 Active, EM1 Sleep, EM2 Deep Sleep, and EM3 Stop.

3.5.7 Watchdog Timer (WDOG)

The watchdog timer can act both as an independent watchdog or as a watchdog synchronous with the CPU clock. It has windowed monitoring capabilities, and can generate a reset or different interrupts depending on the failure mode of the system. The watchdog can also monitor autonomous systems driven by PRS.

3.6 Communications and Other Digital Peripherals

3.6.1 Universal Synchronous/Asynchronous Receiver/Transmitter (USART)

The Universal Synchronous/Asynchronous Receiver/Transmitter is a flexible serial I/O interface. It supports full duplex asynchronous UART communication with hardware flow control as well as RS-485, SPI, MicroWire and 3-wire. It can also interface with devices supporting:

- ISO7816 SmartCards
- IrDA
- I²S

3.6.2 Universal Asynchronous Receiver/Transmitter (UART)

The Universal Asynchronous Receiver/Transmitter is a subset of the USART peripheral, supporting full duplex asynchronous UART communication with hardware flow control and RS-485.

3.6.3 Low Energy Universal Asynchronous Receiver/Transmitter (LEUART)

The unique LEUART™ provides two-way UART communication on a strict power budget. Only a 32.768 kHz clock is needed to allow UART communication up to 9600 baud. The LEUART includes all necessary hardware to make asynchronous serial communication possible with a minimum of software intervention and energy consumption.

3.6.4 Inter-Integrated Circuit Interface (I²C)

The I²C interface enables communication between the MCU and a serial I²C bus. It is capable of acting as both a master and a slave and supports multi-master buses. Standard-mode, fast-mode and fast-mode plus speeds are supported, allowing transmission rates from 10 kbit/s up to 1 Mbit/s. Slave arbitration and timeouts are also available, allowing implementation of an SMBus-compliant system. The interface provided to software by the I²C peripheral allows precise timing control of the transmission process and highly automated transfers. Automatic recognition of slave addresses is provided in active and low energy modes.

3.6.5 External Bus Interface (EBI)

The External Bus Interface provides access to external parallel interface devices. The interface is memory mapped into the address bus of the Cortex-M4. This enables seamless access from software without manually manipulating the I/O settings each time a read or write is performed. The data and address lines are multiplexed in order to reduce the number of pins required to interface to external devices. Timing is adjustable to meet specifications of the external devices. The interface is limited to asynchronous devices.

The EBI contains a TFT controller which can drive a TFT via an RGB interface. The TFT controller supports programmable display and port sizes and offers accurate control of frequency and setup and hold timing. Direct Drive is supported for TFT displays which do not have their own frame buffer. In that case TFT Direct Drive can transfer data from either on-chip memory or from an external memory device to the TFT at low CPU load. Automatic alpha-blending and masking is also supported for transfers through the EBI interface.

3.6.6 Quad-SPI Flash Controller (QSPI)

The QSPI provides access to a wide range of flash devices with wide I/O busses. The I/O and clocking configuration is flexible and supports many types of devices. Up to 8-bit wide interfaces are supported. The QSPI handles opcodes, status flag polling, and timing configuration automatically.

The external flash memory is mapped directly to internal memory to allow random access to any word in the flash and direct code execution. An integrated instruction cache minimizes latency and allows efficient code execution. Execute in Place (XIP) is supported for devices with this feature.

Large data chunks can be transferred with DMA as efficiently as possible with high throughput and minimal bus load, utilizing an integrated 1 kB SRAM FIFO.

3.6.7 SDIO Host Controller (SDIO)

The SDIO is an SD3.01 / SDIO3.0 / eMMC4.51-compliant Host Controller interface for transferring data to and from SD/MMC/SDIO devices. The module conforms to the SD Host Controller Standard Specification Version 3.00. The Host Controller handles SDIO/SD/MMC Protocol at the transmission level, packing data, adding cyclic redundancy check (CRC), Start/End bits, and checking for transaction format correctness.

3.6.8 Universal Serial Bus (USB)

The USB is a full-speed/low-speed USB 2.0 compliant host/device controller. The USB can be used in device and host-only configurations, while a clock recovery mechanism allows crystal-less operation in device mode. The USB block supports both full speed (12 MBit/s) and low speed (1.5 MBit/s) operation. When operating as a device, a special Low Energy Mode ensures the current consumption is optimized, enabling USB communications on a strict power budget. The USB device includes an internal dedicated Descriptor-Based Scatter/Gather DMA and supports up to 6 OUT endpoints and 6 IN endpoints, in addition to endpoint 0. The on-chip PHY includes internal pull-up and pull-down resistors, as well as voltage comparators for monitoring the VBUS voltage and A/B device identification using the ID line.

3.6.9 Ethernet (ETH)

The Ethernet peripheral is compliant with IEEE 802.3-2002 for Ethernet MAC. It supports 802.1AS and IEEE 1588 precision clock synchronization protocol, as well as 802.3az Energy Efficient Ethernet. The ETH supports a wide variety of frame formats and standard operating modes such as MII/RMII. Direct Memory Access (DMA) support makes it possible to transmit and receive large frames at high data rates with minimal CPU overhead. The Ethernet peripheral supports 10 Mbps and 100 Mbps operation, and includes a total of 8 kB of dedicated dual-port RAM FIFO (4 kB for TX and 4 kB for RX).

3.6.10 Controller Area Network (CAN)

The CAN peripheral provides support for communication at up to 1 Mbps over CAN protocol version 2.0 part A and B. It includes 32 message objects with independent identifier masks and retains message RAM in EM2. Automatic retransmission may be disabled in order to support Time Triggered CAN applications.

3.6.11 Peripheral Reflex System (PRS)

The Peripheral Reflex System provides a communication network between different peripherals without software involvement. Peripherals producing Reflex signals are called producers. The PRS routes Reflex signals from producers to consumer peripherals, which in turn perform actions in response. Edge triggers and other functionality such as simple logic operations (AND, OR, NOT) can be applied by the PRS to the signals. The PRS allows peripheral to act autonomously without waking the MCU core, saving power.

3.6.12 Low Energy Sensor Interface (LESENSE)

The Low Energy Sensor Interface LESENSE™ is a highly configurable sensor interface with support for up to 16 individually configurable sensors. By controlling the analog comparators, ADC, and DAC, LESENSE is capable of supporting a wide range of sensors and measurement schemes, and can for instance measure LC sensors, resistive sensors and capacitive sensors. LESENSE also includes a programmable finite state machine which enables simple processing of measurement results without CPU intervention. LESENSE is available in energy mode EM2, in addition to EM0 and EM1, making it ideal for sensor monitoring in applications with a strict energy budget.

3.7 Security Features

3.7.1 General Purpose Cyclic Redundancy Check (GPCRC)

The GPCRC block implements a Cyclic Redundancy Check (CRC) function. It supports both 32-bit and 16-bit polynomials. The supported 32-bit polynomial is 0x04C11DB7 (IEEE 802.3), while the 16-bit polynomial can be programmed to any value, depending on the needs of the application.

3.7.2 Crypto Accelerator (CRYPTO)

The Crypto Accelerator is a fast and energy-efficient autonomous hardware encryption and decryption accelerator. Giant Gecko Series 1 devices support AES encryption and decryption with 128- or 256-bit keys, ECC over both GF(P) and GF(2^m), and SHA-1 and SHA-2 (SHA-224 and SHA-256).

Supported block cipher modes of operation for AES include: ECB, CTR, CBC, PCBC, CFB, OFB, GCM, CBC-MAC, GMAC and CCM.

Supported ECC NIST recommended curves include P-192, P-224, P-256, K-163, K-233, B-163 and B-233.

The CRYPTO peripheral allows fast processing of GCM (AES), ECC and SHA with little CPU intervention. CRYPTO also provides trigger signals for DMA read and write operations.

3.7.3 True Random Number Generator (TRNG)

The TRNG is a non-deterministic random number generator based on a full hardware solution. The TRNG is validated with NIST800-22 and AIS-31 test suites as well as being suitable for FIPS 140-2 certification (for the purposes of cryptographic key generation).

3.7.4 Security Management Unit (SMU)

The Security Management Unit (SMU) allows software to set up fine-grained security for peripheral access, which is not possible in the Memory Protection Unit (MPU). Peripherals may be secured by hardware on an individual basis, such that only privileged accesses to the peripheral's register interface will be allowed. When an access fault occurs, the SMU reports the specific peripheral involved and can optionally generate an interrupt.

3.8 Analog

3.8.1 Analog Port (APORT)

The Analog Port (APORT) is an analog interconnect matrix allowing access to many analog peripherals on a flexible selection of pins. Each APORT bus consists of analog switches connected to a common wire. Since many clients can operate differentially, buses are grouped by X/Y pairs.

3.8.2 Analog Comparator (ACMP)

The Analog Comparator is used to compare the voltage of two analog inputs, with a digital output indicating which input voltage is higher. Inputs are selected from among internal references and external pins. The tradeoff between response time and current consumption is configurable by software. Two 6-bit reference dividers allow for a wide range of internally-programmable reference sources. The ACMP can also be used to monitor the supply voltage. An interrupt can be generated when the supply falls below or rises above the programmable threshold.

3.8.3 Analog to Digital Converter (ADC)

The ADC is a Successive Approximation Register (SAR) architecture, with a resolution of up to 12 bits at up to 1 Msps. The output sample resolution is configurable and additional resolution is possible using integrated hardware for averaging over multiple samples. The ADC includes integrated voltage references and an integrated temperature sensor. Inputs are selectable from a wide range of sources, including pins configurable as either single-ended or differential.

3.8.4 Capacitive Sense (CSEN)

The CSEN peripheral is a dedicated Capacitive Sensing block for implementing touch-sensitive user interface elements such as switches and sliders. The CSEN peripheral uses a charge ramping measurement technique, which provides robust sensing even in adverse conditions including radiated noise and moisture. The peripheral can be configured to take measurements on a single port pin or scan through multiple pins and store results to memory through DMA. Several channels can also be shorted together to measure the combined capacitance or implement wake-on-touch from very low energy modes. Hardware includes a digital accumulator and an averaging filter, as well as digital threshold comparators to reduce software overhead.

3.8.5 Digital to Analog Current Converter (IDAC)

The IDAC can source or sink a configurable constant current. This current can be driven on an output pin or routed to the selected ADC input pin for capacitive sensing. The full-scale current is programmable between 0.05 μA and 64 μA with several ranges consisting of various step sizes.

3.8.6 Digital to Analog Converter (VDAC)

The Digital to Analog Converter (VDAC) can convert a digital value to an analog output voltage. The VDAC is a fully differential, 500 ksp/s, 12-bit converter. The opamps are used in conjunction with the VDAC, to provide output buffering. One opamp is used per single-ended channel, or two opamps are used to provide differential outputs. The VDAC may be used for a number of different applications such as sensor interfaces or sound output. The VDAC can generate high-resolution analog signals while the MCU is operating at low frequencies and with low total power consumption. Using DMA and a timer, the VDAC can be used to generate waveforms without any CPU intervention. The VDAC is available in all energy modes down to and including EM3.

3.8.7 Operational Amplifiers

The opamps are low power amplifiers with a high degree of flexibility targeting a wide variety of standard opamp application areas, and are available down to EM3. With flexible built-in programming for gain and interconnection they can be configured to support multiple common opamp functions. All pins are also available externally for filter configurations. Each opamp has a rail to rail input and a rail to rail output. They can be used in conjunction with the VDAC peripheral or in stand-alone configurations. The opamps save energy, PCB space, and cost as compared with standalone opamps because they are integrated on-chip.

3.8.8 Liquid Crystal Display Driver (LCD)

The LCD driver is capable of driving a segmented LCD display with up to 8x36 segments. A voltage boost function enables it to provide the LCD display with higher voltage than the supply voltage for the device. A patented charge redistribution driver can reduce the LCD module supply current by up to 40%. In addition, an animation feature can run custom animations on the LCD display without any CPU intervention. The LCD driver can also remain active even in Energy Mode 2 and provides a Frame Counter interrupt that can wake-up the device on a regular basis for updating data.

3.9 Reset Management Unit (RMU)

The RMU is responsible for handling reset of the EFM32GG11. A wide range of reset sources are available, including several power supply monitors, pin reset, software controlled reset, core lockup reset, and watchdog reset.

3.10 Core and Memory

3.10.1 Processor Core

The ARM Cortex-M processor includes a 32-bit RISC processor integrating the following features and tasks in the system:

- ARM Cortex-M4 RISC processor with FPU achieving 1.25 Dhrystone MIPS/MHz
- Memory Protection Unit (MPU) supporting up to 8 memory segments
- Embedded Trace Macrocell (ETM) for real-time trace and debug
- Up to 2048 kB flash program memory
 - Dual-bank memory with read-while-write support
- Up to 512 kB RAM data memory
- Configuration and event handling of all modules
- 2-pin Serial-Wire or 4-pin JTAG debug interface

3.10.2 Memory System Controller (MSC)

The Memory System Controller (MSC) is the program memory unit of the microcontroller. The flash memory is readable and writable from both the Cortex-M and DMA. The flash memory is divided into two blocks; the main block and the information block. Program code is normally written to the main block, whereas the information block is available for special user data and flash lock bits. There is also a read-only page in the information block containing system and device calibration data. Read and write operations are supported in energy modes EM0 Active and EM1 Sleep.

3.10.3 Linked Direct Memory Access Controller (LDMA)

The Linked Direct Memory Access (LDMA) controller allows the system to perform memory operations independently of software. This reduces both energy consumption and software workload. The LDMA allows operations to be linked together and staged, enabling sophisticated operations to be implemented.

3.10.4 Bootloader

All devices come pre-programmed with a UART bootloader. This bootloader resides in flash and can be erased if it is not needed. More information about the bootloader protocol and usage can be found in *AN0003: UART Bootloader*. Application notes can be found on the Silicon Labs website (www.silabs.com/32bit-appnotes) or within Simplicity Studio in the **[Documentation]** area.

3.11 Memory Map

The EFM32GG11 memory map is shown in the figures below. RAM and flash sizes are for the largest memory configuration.



Figure 3.2. EFM32GG11 Memory Map — Core Peripherals and Code Space

0x40024000	ETH	0xffffffff	PRS	0x400e6000
0x40022400		0xe0100000	RMU	0x400e5400
0x40022000	USB	0xffffffff		0x400e5000
0x40020400		0xd0000000	CMU	0x400e4400
0x40020000	SMU	0xc0000000		0x400e4000
0x4001d400		0xb0000000	EMU	0x400e3400
0x4001d000	TRNG0	0xa0000000		0x400e3000
0x4001c800		0x80000000	CRYOTIMER	0x4008f400
0x4001c400	QSPI0	0x80000000		0x4008f000
0x4001c000	GPCRC	0x80000000	CSEN	0x4008e400
0x4001b000		0x80000000		0x4008e000
0x4001ac00	WTIMER3	0x80000000	I2C2	0x40089c00
0x4001a800	WTIMER2	0x80000000	I2C1	0x40089800
0x4001a400	WTIMER1	0x80000000	I2C0	0x40089400
0x4001a000	WTIMER0	0x80000000	GPIO	0x40089000
0x40019c00		0x460f03ff		0x40088000
0x40019800	TIMER6	(Peripherals / CRYPTO0) 0x46000000	VDAC0	0x40086400
0x40019400	TIMER5			0x40086000
0x40019000	TIMER4	0x440f03ff	IDAC0	0x40084400
0x40018c00	TIMER3	(Peripherals / CRYPTO0) 0x44000000		0x40084000
0x40018800	TIMER2	0x43110000	ADC1	0x40082800
0x40018400	TIMER1		ADC0	0x40082400
0x40018000	TIMER0	0x43e3ffff		0x40082000
0x40017c00		(Peripherals / CRYPTO0 / SDIO) 0x42000000	ACMP3	0x40081000
0x40017000			ACMP2	0x40080c00
0x40016c00	UART1	0x40110000	ACMP1	0x40080800
0x40016000	UART0	0x40100000	ACMP0	0x40080400
0x40015400		0x400f03ff		0x40080000
0x40015000		0x400f2000	PCNT2	0x4006ec00
0x40014c00	USART5	0x400f03ff	PCNT1	0x4006e800
0x40014000	USART4	0x400f03ff	PCNT0	0x4006e400
0x40013c00	USART3	0x400f03ff		0x4006e000
0x40013000	USART2	0x400f03ff	LEUART1	0x4006a800
0x40012c00	USART1	0x400f03ff	LEUART0	0x4006a400
0x40012000	USART0	0x400f03ff		0x4006a000
0x40011400		0x40000000	LETIMER1	0x40066800
0x40011000	EBI	0x25000000	LETIMER0	0x40066400
0x40010c00		0x22000000		0x40066000
0x40010800		0x22000000	RTCC	0x40062400
0x40010400	CAN1	0x21000000		0x40062000
0x40010000	CAN0	0x20000000	RTC	0x40060400
0x4000b400		0x20040000		0x40060000
0x4000b000		0x2003ffff	LESENSE	0x40055400
0x4000ac00	LDMA	0x20020000		0x40055000
0x4000a800		0x2001ffff	LCD	0x40054400
0x4000a400		0x20010000		0x40054000
0x4000a000	FPUEH	0x1fffffff	WDOG1	0x40052800
0x40009c00			WDOG0	0x40052400
0x40009000	MSC	0x00000000		0x40052000
0x40008000				
0x40007000				
0x40006000				
0x40005000				
0x40004000				
0x40003000				
0x40002000				
0x40001000				
0x40000000				

Figure 3.3. EFM32GG11 Memory Map — Peripherals

3.12 Configuration Summary

The features of the EFM32GG11 are a subset of the feature set described in the device reference manual. The table below describes device specific implementation of the features. Remaining modules support full configuration.

Table 3.2. Configuration Summary

Module	Configuration	Pin Connections
USART0	IrDA, SmartCard	US0_TX, US0_RX, US0_CLK, US0_CS
USART1	I ² S, SmartCard	US1_TX, US1_RX, US1_CLK, US1_CS
USART2	IrDA, SmartCard, High-Speed	US2_TX, US2_RX, US2_CLK, US2_CS
USART3	I ² S, SmartCard	US3_TX, US3_RX, US3_CLK, US3_CS
USART4	I ² S, SmartCard	US4_TX, US4_RX, US4_CLK, US4_CS
USART5	SmartCard	US5_TX, US5_RX, US5_CLK, US5_CS
TIMER0	with DTI	TIM0_CC[2:0], TIM0_CDTI[2:0]
TIMER1	-	TIM1_CC[3:0]
TIMER2	with DTI	TIM2_CC[2:0], TIM2_CDTI[2:0]
TIMER3	-	TIM3_CC[2:0]
TIMER4	with DTI	TIM4_CC[2:0], TIM4_CDTI[2:0]
TIMER5	-	TIM5_CC[2:0]
TIMER6	with DTI	TIM6_CC[2:0], TIM6_CDTI[2:0]
WTIMER0	with DTI	WTIM0_CC[2:0], WTIM0_CDTI[2:0]
WTIMER1	-	WTIM1_CC[3:0]
WTIMER2	-	WTIM2_CC[2:0]
WTIMER3	-	WTIM3_CC[2:0]
ADC0	with temperature sensor	See 5.22 Analog Port (APORT) Client Maps
ADC1	-	See 5.22 Analog Port (APORT) Client Maps

4. Electrical Specifications

4.1 Electrical Characteristics

All electrical parameters in all tables are specified under the following conditions, unless stated otherwise:

- Typical values are based on $T_{AMB}=25\text{ }^{\circ}\text{C}$ and $V_{DD}=3.3\text{ V}$, by production test and/or technology characterization.
- Minimum and maximum values represent the worst conditions across supply voltage, process variation, and operating temperature, unless stated otherwise.

Refer to [4.1.2.1 General Operating Conditions](#) for more details about operational supply and temperature limits.

4.1.1 Absolute Maximum Ratings

Stresses above those listed below may cause permanent damage to the device. This is a stress rating only and functional operation of the devices at those or any other conditions above those indicated in the operation listings of this specification is not implied. Exposure to maximum rating conditions for extended periods may affect device reliability. For more information on the available quality and reliability data, see the Quality and Reliability Monitor Report at <http://www.silabs.com/support/quality/pages/default.aspx>.

Table 4.1. Absolute Maximum Ratings

Parameter	Symbol	Test Condition	Min	Typ	Max	Unit
Storage temperature range	T _{STG}		-50	—	150	°C
Voltage on supply pins other than VREGI and VBUS	V _{DDMAX}		-0.3	—	3.8	V
Voltage ramp rate on any supply pin	V _{DDRAMPMAX}		—	—	1	V / μs
DC voltage on any GPIO pin	V _{DIGPIN}	5V tolerant GPIO pins ^{1 2 3}	-0.3	—	Min of 5.25 and IOVDD +2	V
		LCD pins ³	-0.3	—	Min of 3.8 and IOVDD +2	V
		Standard GPIO pins	-0.3	—	IOVDD+0.3	V
Total current into VDD power lines	I _{VDDMAX}	Source	—	—	200	mA
Total current into VSS ground lines	I _{VSSMAX}	Sink	—	—	200	mA
Current per I/O pin	I _{IOMAX}	Sink	—	—	50	mA
		Source	—	—	50	mA
Current for all I/O pins	I _{IOALLMAX}	Sink	—	—	200	mA
		Source	—	—	200	mA
Junction temperature	T _J	-G grade devices	-40	—	105	°C
		-I grade devices	-40	—	125	°C
Voltage on regulator supply pins VREGI and VBUS	V _{VREGI}		-0.3	—	5.5	V

Note:

- When a GPIO pin is routed to the analog module through the APORT, the maximum voltage = IOVDD.
- Valid for IOVDD in valid operating range or when IOVDD is undriven (high-Z). If IOVDD is connected to a low-impedance source below the valid operating range (e.g. IOVDD shorted to VSS), the pin voltage maximum is IOVDD + 0.3 V, to avoid exceeding the maximum IO current specifications.
- To operate above the IOVDD supply rail, over-voltage tolerance must be enabled according to the GPIO_Px_OVTDIS register. Pins with over-voltage tolerance disabled have the same limits as Standard GPIO.

4.1.2 Operating Conditions

When assigning supply sources, the following requirements must be observed:

- VREGVDD must be greater than or equal to AVDD, DVDD and all IOVDD supplies.
- VREGVDD = AVDD
- DVDD \leq AVDD
- IOVDD \leq AVDD

4.1.2.1 General Operating Conditions

Table 4.2. General Operating Conditions

Parameter	Symbol	Test Condition	Min	Typ	Max	Unit
Operating ambient temperature range ⁶	T _A	-G temperature grade	-40	25	85	°C
		-I temperature grade	-40	25	125	°C
AVDD supply voltage ²	V _{AVDD}		1.8	3.3	3.8	V
VREGVDD operating supply voltage ^{2 1}	V _{VREGVDD}	DCDC in regulation	2.4	3.3	3.8	V
		DCDC in bypass, 50mA load	1.8	3.3	3.8	V
		DCDC not in use. DVDD externally shorted to VREGVDD	1.8	3.3	3.8	V
VREGVDD current	I _{VREGVDD}	DCDC in bypass, T ≤ 85 °C	—	—	200	mA
		DCDC in bypass, T > 85 °C	—	—	100	mA
DVDD operating supply voltage	V _{DVDD}		1.62	—	V _{VREGVDD}	V
IOVDD operating supply voltage	V _{IOVDD}	All IOVDD pins ⁵	1.62	—	V _{VREGVDD}	V
DECOUPLE output capacitor ^{3 4}	C _{DECOUPLE}		0.75	1.0	2.75	μF
HFCORECLK frequency	f _{CORE}	VSCALE2, MODE = WS3	—	—	72	MHz
		VSCALE2, MODE = WS2	—	—	54	MHz
		VSCALE2, MODE = WS1	—	—	36	MHz
		VSCALE2, MODE = WS0	—	—	18	MHz
		VSCALE0, MODE = WS2	—	—	20	MHz
		VSCALE0, MODE = WS1	—	—	14	MHz
		VSCALE0, MODE = WS0	—	—	7	MHz
HFCLK frequency	f _{HFCLK}	VSCALE2	—	—	72	MHz
		VSCALE0	—	—	20	MHz
HFSRCCLK frequency	f _{HFSRCCLK}	VSCALE2	—	—	72	MHz
		VSCALE0	—	—	20	MHz
HFBUSCLK frequency	f _{HFBUSCLK}	VSCALE2	—	—	50	MHz
		VSCALE0	—	—	20	MHz
HFPERCLK frequency	f _{HFPERCLK}	VSCALE2	—	—	50	MHz
		VSCALE0	—	—	20	MHz
HFPERBCLK frequency	f _{HFPERBCLK}	VSCALE2	—	—	72	MHz
		VSCALE0	—	—	20	MHz
HFPERCCLK frequency	f _{HFPERCCLK}	VSCALE2	—	—	50	MHz
		VSCALE0	—	—	20	MHz

Parameter	Symbol	Test Condition	Min	Typ	Max	Unit
Note:						
1. The minimum voltage required in bypass mode is calculated using R_{BYP} from the DCDC specification table. Requirements for other loads can be calculated as $V_{DVDD_min} + I_{LOAD} * R_{BYP_max}$.						
2. VREGVDD must be tied to AVDD. Both VREGVDD and AVDD minimum voltages must be satisfied for the part to operate.						
3. The system designer should consult the characteristic specs of the capacitor used on DECOUPLE to ensure its capacitance value stays within the specified bounds across temperature and DC bias.						
4. VSCALE0 to VSCALE2 voltage change transitions occur at a rate of 10 mV / usec for approximately 20 usec. During this transition, peak currents will be dependent on the value of the DECOUPLE output capacitor, from 35 mA (with a 1 μ F capacitor) to 70 mA (with a 2.7 μ F capacitor).						
5. When the CSEN peripheral is used with chopping enabled (CSEN_CTRL_CHOPEN = ENABLE), IOVDD must be equal to AVDD.						
6. The maximum limit on T_A may be lower due to device self-heating, which depends on the power dissipation of the specific application. $T_A (max) = T_J (max) - (THETA_{JA} \times PowerDissipation)$. Refer to the Absolute Maximum Ratings table and the Thermal Characteristics table for T_J and $THETA_{JA}$.						

4.1.3 Thermal Characteristics

Table 4.3. Thermal Characteristics

Parameter	Symbol	Test Condition	Min	Typ	Max	Unit
Thermal resistance, QFN64 Package	THETA _{JA_QFN64}	4-Layer PCB, Air velocity = 0 m/s	—	17.8	—	°C/W
		4-Layer PCB, Air velocity = 1 m/s	—	15.4	—	°C/W
		4-Layer PCB, Air velocity = 2 m/s	—	13.8	—	°C/W
Thermal resistance, TQFP64 Package	THE-TA _{JA_TQFP64}	4-Layer PCB, Air velocity = 0 m/s	—	33.9	—	°C/W
		4-Layer PCB, Air velocity = 1 m/s	—	32.1	—	°C/W
		4-Layer PCB, Air velocity = 2 m/s	—	30.1	—	°C/W
Thermal resistance, TQFP100 Package	THE-TA _{JA_TQFP100}	4-Layer PCB, Air velocity = 0 m/s	—	44.1	—	°C/W
		4-Layer PCB, Air velocity = 1 m/s	—	37.7	—	°C/W
		4-Layer PCB, Air velocity = 2 m/s	—	35.5	—	°C/W
Thermal resistance, BGA112 Package	THE-TA _{JA_BGA112}	4-Layer PCB, Air velocity = 0 m/s	—	42.0	—	°C/W
		4-Layer PCB, Air velocity = 1 m/s	—	37.0	—	°C/W
		4-Layer PCB, Air velocity = 2 m/s	—	35.3	—	°C/W
Thermal resistance, BGA120 Package	THE-TA _{JA_BGA120}	4-Layer PCB, Air velocity = 0 m/s	—	47.9	—	°C/W
		4-Layer PCB, Air velocity = 1 m/s	—	41.8	—	°C/W
		4-Layer PCB, Air velocity = 2 m/s	—	39.6	—	°C/W
Thermal resistance, BGA152 Package	THE-TA _{JA_BGA152}	4-Layer PCB, Air velocity = 0 m/s	—	35.7	—	°C/W
		4-Layer PCB, Air velocity = 1 m/s	—	31.0	—	°C/W
		4-Layer PCB, Air velocity = 2 m/s	—	29.5	—	°C/W
Thermal resistance, BGA192 Package	THE-TA _{JA_BGA192}	4-Layer PCB, Air velocity = 0 m/s	—	47.9	—	°C/W
		4-Layer PCB, Air velocity = 1 m/s	—	41.8	—	°C/W
		4-Layer PCB, Air velocity = 2 m/s	—	39.6	—	°C/W

4.1.4 DC-DC Converter

Test conditions: L_DCDC=4.7 μ H (Murata LQH3NPN4R7MM0L), C_DCDC=4.7 μ F (Samsung CL10B475KQ8NQNC), V_DCDC_I=3.3 V, V_DCDC_O=1.8 V, I_DCDC_LOAD=50 mA, Heavy Drive configuration, F_DCDC_LN=7 MHz, unless otherwise indicated.

Table 4.4. DC-DC Converter

Parameter	Symbol	Test Condition	Min	Typ	Max	Unit
Input voltage range	V _{DCDC_I}	Bypass mode, I _{DCDC_LOAD} = 50 mA	1.8	—	V _{VREGVDD_MAX}	V
		Low noise (LN) mode, 1.8 V output, I _{DCDC_LOAD} = 100 mA, or Low power (LP) mode, 1.8 V output, I _{DCDC_LOAD} = 10 mA	2.4	—	V _{VREGVDD_MAX}	V
		Low noise (LN) mode, 1.8 V output, I _{DCDC_LOAD} = 200 mA	2.6	—	V _{VREGVDD_MAX}	V
Output voltage programmable range ¹	V _{DCDC_O}		1.8	—	V _{VREGVDD}	V
Regulation DC accuracy	ACC _{DC}	Low Noise (LN) mode, 1.8 V target output	1.7	—	1.9	V
Regulation window ⁴	WIN _{REG}	Low Power (LP) mode, LPCMPBIASEM _{xx} ³ = 0, 1.8 V target output, I _{DCDC_LOAD} \leq 75 μ A	1.63	—	2.2	V
		Low Power (LP) mode, LPCMPBIASEM _{xx} ³ = 3, 1.8 V target output, I _{DCDC_LOAD} \leq 10 mA	1.63	—	2.1	V
Steady-state output ripple	V _R		—	3	—	mV _{pp}
Output voltage under/overshoot	V _{OV}	CCM Mode (LNFORCECCM ³ = 1), Load changes between 0 mA and 100 mA	—	25	60	mV
		DCM Mode (LNFORCECCM ³ = 0), Load changes between 0 mA and 10 mA	—	45	90	mV
		Overshoot during LP to LN CCM/DCM mode transitions compared to DC level in LN mode	—	200	—	mV
		Undershoot during BYP/LP to LN CCM (LNFORCECCM ³ = 1) mode transitions compared to DC level in LN mode	—	40	—	mV
		Undershoot during BYP/LP to LN DCM (LNFORCECCM ³ = 0) mode transitions compared to DC level in LN mode	—	100	—	mV
DC line regulation	V _{REG}	Input changes between V _{VREGVDD_MAX} and 2.4 V	—	0.1	—	%
DC load regulation	I _{REG}	Load changes between 0 mA and 100 mA in CCM mode	—	0.1	—	%

Parameter	Symbol	Test Condition	Min	Typ	Max	Unit
Max load current	I _{LOAD_MAX}	Low noise (LN) mode, Heavy Drive ² , T ≤ 85 °C	—	—	200	mA
		Low noise (LN) mode, Heavy Drive ² , T > 85 °C	—	—	100	mA
		Low noise (LN) mode, Medium Drive ²	—	—	100	mA
		Low noise (LN) mode, Light Drive ²	—	—	50	mA
		Low power (LP) mode, LPCMPBIASEMxx ³ = 0	—	—	75	μA
		Low power (LP) mode, LPCMPBIASEMxx ³ = 3	—	—	10	mA
DCDC nominal output capacitor ⁵	C _{DCDC}	25% tolerance	1	4.7	4.7	μF
DCDC nominal output inductor	L _{DCDC}	20% tolerance	4.7	4.7	4.7	μH
Resistance in Bypass mode	R _{BYP}		—	1.2	2.5	Ω

Note:

1. Due to internal dropout, the DC-DC output will never be able to reach its input voltage, V_{VREGVDD}.
2. Drive levels are defined by configuration of the PFETCNT and NFETCNT registers. Light Drive: PFETCNT=NFETCNT=3; Medium Drive: PFETCNT=NFETCNT=7; Heavy Drive: PFETCNT=NFETCNT=15.
3. LPCMPBIASEMxx refers to either LPCMPBIASEM234H in the EMU_DCDCMISCCTRL register or LPCMPBIASEM01 in the EMU_DCDCLOEM01CFG register, depending on the energy mode.
4. LP mode controller is a hysteretic controller that maintains the output voltage within the specified limits.
5. Output voltage under/over-shoot and regulation are specified with C_{DCDC} 4.7 μF. Different settings for DCDCLNCOMPCTRL must be used if C_{DCDC} is lower than 4.7 μF. See Application Note AN0948 for details.

4.1.5 5V Regulator

$V_{VREGI} = 5\text{ V}$, $V_{VREGO} = 3.3\text{ V}$, $C_{VREGI} = 10\text{ }\mu\text{F}$, $C_{VREGO} = 4.7\text{ }\mu\text{F}$, unless otherwise specified.

Table 4.5. 5V Regulator

Parameter	Symbol	Test Condition	Min	Typ	Max	Unit
VREGI or VBUS input voltage range	V_{VREGI}	Regulating output	2.7	—	5.5	V
		Bypass mode enabled	2.7	—	3.8	V
VREGO output voltage	V_{VREGO}	Regulating output, 3.3 V setting	3.1	3.3	3.5	V
		EM4S open-loop output, $I_{OUT} < 100\text{ }\mu\text{A}$	1.8	—	3.8	V
Voltage output step size	V_{VREGO_SS}		—	0.1	—	V
Resistance in Bypass Mode	R_{BYP}	Bypass mode enabled	—	1.2	2.5	Ω
Output current	I_{OUT}	EM0 or EM1, $V_{VREGI} > V_{VREGO} + 0.6\text{ V}$	—	—	200	mA
		EM0 or EM1, $V_{VREGI} > V_{VREGO} + 0.3\text{ V}$	—	—	100	mA
		EM2, EM3, or EM4H, $V_{VREGI} > V_{VREGO} + 0.6\text{ V}$	—	—	2	mA
		EM2, EM3, or EM4H, $V_{VREGI} > V_{VREGO} + 0.3\text{ V}$	—	—	0.5	mA
		EM4S	—	—	20	μA
Load regulation	LR_{VREGO}	EM0 or EM1	—	0.10	—	mV/mA
		EM2, EM3, or EM4H	—	2.5	—	mV/mA
DC power supply rejection	PSR_{DC}		—	40	—	dB
VREGI or VBUS bypass capacitance	C_{VREGI}		—	10	—	μF
VREGO bypass capacitance	C_{VREGO}		1	4.7	10	μF
Supply current consumption	I_{VREGI}	EM0 or EM1, No load	—	29	—	μA
		EM2, EM3, or EM4H, No load	—	270	—	nA
		EM4S, No load	—	70	—	nA
VREGI and VBUS detection high threshold	V_{DET_H}		0.9	1.15	—	V
VREGI and VBUS detection low threshold	V_{DET_L}		—	1.07	1.45	V
Current monitor transfer ratio	$IMON_{XF}$	Translation of current through VREGO path to voltage at ADC input	—	0.35	—	mA/mV

4.1.6 Backup Supply Domain

Table 4.6. Backup Supply Domain

Parameter	Symbol	Test Condition	Min	Typ	Max	Unit
Backup supply voltage range	V _{BU_VIN}		1.8	—	3.8	V
PWRRES resistor	R _{PWRRES}	EMU_BUCTRL_PWRRES = RES0	3400	3900	4400	Ω
		EMU_BUCTRL_PWRRES = RES1	1450	1800	2150	Ω
		EMU_BUCTRL_PWRRES = RES2	1000	1350	1700	Ω
		EMU_BUCTRL_PWRRES = RES3	525	815	1100	Ω
Output impedance between BU_VIN and BU_VOUT ²	R _{BU_VOUT}	EMU_BUCTRL_VOUTRES = STRONG	35	110	185	Ω
		EMU_BUCTRL_VOUTRES = MED	475	775	1075	Ω
		EMU_BUCTRL_VOUTRES = WEAK	5600	6500	7400	Ω
Supply current	I _{BU_VIN}	BU_VIN not powering backup domain, 25 °C	—	11	100	nA
		BU_VIN powering backup domain, 25 °C ¹	—	550	2500	nA

Note:

1. Additional current required by backup circuitry when backup is active. Includes supply current of backup switches and backup regulator. Does not include supply current required for backed-up circuitry.
2. BU_VOUT and BU_STAT signals are not available in all package configurations. Check the device pinout for availability.

4.1.7 Current Consumption

4.1.7.1 Current Consumption 3.3 V without DC-DC Converter

Unless otherwise indicated, typical conditions are: VREGVDD = AVDD = DVDD = 3.3 V. T = 25 °C. DCDC is off. Minimum and maximum values in this table represent the worst conditions across process variation at T = 25 °C.

Table 4.7. Current Consumption 3.3 V without DC-DC Converter

Parameter	Symbol	Test Condition	Min	Typ	Max	Unit
Current consumption in EM0 mode with all peripherals disabled	I _{ACTIVE}	72 MHz HFRCO, CPU running Prime from flash	—	120	—	μA/MHz
		72 MHz HFRCO, CPU running while loop from flash	—	120	130	μA/MHz
		72 MHz HFRCO, CPU running CoreMark loop from flash	—	140	—	μA/MHz
		50 MHz crystal, CPU running while loop from flash	—	123	—	μA/MHz
		48 MHz HFRCO, CPU running while loop from flash	—	122	135	μA/MHz
		32 MHz HFRCO, CPU running while loop from flash	—	124	—	μA/MHz
		26 MHz HFRCO, CPU running while loop from flash	—	126	140	μA/MHz
		16 MHz HFRCO, CPU running while loop from flash	—	131	—	μA/MHz
		1 MHz HFRCO, CPU running while loop from flash	—	319	470	μA/MHz
Current consumption in EM0 mode with all peripherals disabled and voltage scaling enabled	I _{ACTIVE_VS}	19 MHz HFRCO, CPU running while loop from flash	—	107	—	μA/MHz
		1 MHz HFRCO, CPU running while loop from flash	—	262	—	μA/MHz
Current consumption in EM1 mode with all peripherals disabled	I _{EM1}	72 MHz HFRCO	—	57	67	μA/MHz
		50 MHz crystal	—	60	—	μA/MHz
		48 MHz HFRCO	—	59	70	μA/MHz
		32 MHz HFRCO	—	61	—	μA/MHz
		26 MHz HFRCO	—	63	75	μA/MHz
		16 MHz HFRCO	—	68	—	μA/MHz
		1 MHz HFRCO	—	255	420	μA/MHz
Current consumption in EM1 mode with all peripherals disabled and voltage scaling enabled	I _{EM1_VS}	19 MHz HFRCO	—	55	—	μA/MHz
		1 MHz HFRCO	—	210	—	μA/MHz

Parameter	Symbol	Test Condition	Min	Typ	Max	Unit
Current consumption in EM2 mode, with voltage scaling enabled	I _{EM2_VS}	Full 512 kB RAM retention and RTCC running from LFXO	—	3.9	—	μA
		Full 512 kB RAM retention and RTCC running from LFRCO	—	4.3	—	μA
		16 kB (1 bank) RAM retention and RTCC running from LFRCO ²	—	2.8	5.5	μA
Current consumption in EM3 mode, with voltage scaling enabled	I _{EM3_VS}	Full 512 kB RAM retention and CRYOTIMER running from ULFRCO	—	3.6	7	μA
Current consumption in EM4H mode, with voltage scaling enabled	I _{EM4H_VS}	128 byte RAM retention, RTCC running from LFXO	—	1.08	—	μA
		128 byte RAM retention, CRYOTIMER running from ULFRCO	—	0.69	—	μA
		128 byte RAM retention, no RTCC	—	0.6	1	μA
Current consumption in EM4S mode	I _{EM4S}	No RAM retention, no RTCC	—	0.06	0.2	μA
Current consumption of peripheral power domain 1, with voltage scaling enabled	I _{PD1_VS}	Additional current consumption in EM2/3 when any peripherals on power domain 1 are enabled ¹	—	0.68	—	μA
Current consumption of peripheral power domain 2, with voltage scaling enabled	I _{PD2_VS}	Additional current consumption in EM2/3 when any peripherals on power domain 2 are enabled ¹	—	0.28	—	μA

Note:

1. Extra current consumed by power domain. Does not include current associated with the enabled peripherals. See [3.2.4 EM2 and EM3 Power Domains](#) for a list of the peripherals in each power domain.
2. CMU_LFRCOCTRL_ENVREF = 1, CMU_LFRCOCTRL_VREFUPDATE = 1

4.1.7.2 Current Consumption 3.3 V using DC-DC Converter

Unless otherwise indicated, typical conditions are: VREGVDD = AVDD = IOVDD = 3.3 V, DVDD = 1.8 V DC-DC output. T = 25 °C. Minimum and maximum values in this table represent the worst conditions across process variation at T = 25 °C.

Table 4.8. Current Consumption 3.3 V using DC-DC Converter

Parameter	Symbol	Test Condition	Min	Typ	Max	Unit
Current consumption in EM0 mode with all peripherals disabled, DCDC in Low Noise DCM mode ²	I _{ACTIVE_DCM}	72 MHz HFRCO, CPU running Prime from flash	—	80	—	μA/MHz
		72 MHz HFRCO, CPU running while loop from flash	—	80	—	μA/MHz
		72 MHz HFRCO, CPU running CoreMark loop from flash	—	92	—	μA/MHz
		50 MHz crystal, CPU running while loop from flash	—	84	—	μA/MHz
		48 MHz HFRCO, CPU running while loop from flash	—	84	—	μA/MHz
		32 MHz HFRCO, CPU running while loop from flash	—	90	—	μA/MHz
		26 MHz HFRCO, CPU running while loop from flash	—	94	—	μA/MHz
		16 MHz HFRCO, CPU running while loop from flash	—	109	—	μA/MHz
		1 MHz HFRCO, CPU running while loop from flash	—	698	—	μA/MHz
Current consumption in EM0 mode with all peripherals disabled, DCDC in Low Noise CCM mode ¹	I _{ACTIVE_CCM}	72 MHz HFRCO, CPU running Prime from flash	—	84	—	μA/MHz
		72 MHz HFRCO, CPU running while loop from flash	—	84	—	μA/MHz
		72 MHz HFRCO, CPU running CoreMark loop from flash	—	95	—	μA/MHz
		50 MHz crystal, CPU running while loop from flash	—	91	—	μA/MHz
		48 MHz HFRCO, CPU running while loop from flash	—	92	—	μA/MHz
		32 MHz HFRCO, CPU running while loop from flash	—	104	—	μA/MHz
		26 MHz HFRCO, CPU running while loop from flash	—	113	—	μA/MHz
		16 MHz HFRCO, CPU running while loop from flash	—	142	—	μA/MHz
		1 MHz HFRCO, CPU running while loop from flash	—	1264	—	μA/MHz

Parameter	Symbol	Test Condition	Min	Typ	Max	Unit
Current consumption in EM0 mode with all peripherals disabled, DCDC in LP mode ³	I _{ACTIVE_LPM}	32 MHz HFRCO, CPU running while loop from flash	—	82	—	μA/MHz
		26 MHz HFRCO, CPU running while loop from flash	—	83	—	μA/MHz
		16 MHz HFRCO, CPU running while loop from flash	—	88	—	μA/MHz
		1 MHz HFRCO, CPU running while loop from flash	—	257	—	μA/MHz
Current consumption in EM0 mode with all peripherals disabled and voltage scaling enabled, DCDC in Low Noise CCM mode ¹	I _{ACTIVE_CCM_VS}	19 MHz HFRCO, CPU running while loop from flash	—	117	—	μA/MHz
		1 MHz HFRCO, CPU running while loop from flash	—	1231	—	μA/MHz
Current consumption in EM0 mode with all peripherals disabled and voltage scaling enabled, DCDC in LP mode ³	I _{ACTIVE_LPM_VS}	19 MHz HFRCO, CPU running while loop from flash	—	72	—	μA/MHz
		1 MHz HFRCO, CPU running while loop from flash	—	219	—	μA/MHz
Current consumption in EM1 mode with all peripherals disabled, DCDC in Low Noise DCM mode ²	I _{EM1_DCM}	72 MHz HFRCO	—	42	—	μA/MHz
		50 MHz crystal	—	46	—	μA/MHz
		48 MHz HFRCO	—	46	—	μA/MHz
		32 MHz HFRCO	—	53	—	μA/MHz
		26 MHz HFRCO	—	57	—	μA/MHz
		16 MHz HFRCO	—	72	—	μA/MHz
		1 MHz HFRCO	—	663	—	μA/MHz
Current consumption in EM1 mode with all peripherals disabled, DCDC in Low Power mode ³	I _{EM1_LPM}	32 MHz HFRCO	—	42	—	μA/MHz
		26 MHz HFRCO	—	43	—	μA/MHz
		16 MHz HFRCO	—	48	—	μA/MHz
		1 MHz HFRCO	—	219	—	μA/MHz
Current consumption in EM1 mode with all peripherals disabled and voltage scaling enabled, DCDC in Low Noise DCM mode ²	I _{EM1_DCM_VS}	19 MHz HFRCO	—	60	—	μA/MHz
		1 MHz HFRCO	—	637	—	μA/MHz
Current consumption in EM1 mode with all peripherals disabled and voltage scaling enabled. DCDC in LP mode ³	I _{EM1_LPM_VS}	19 MHz HFRCO	—	39	—	μA/MHz
		1 MHz HFRCO	—	190	—	μA/MHz
Current consumption in EM2 mode, with voltage scaling enabled, DCDC in LP mode ³	I _{EM2_VS}	Full 512 kB RAM retention and RTCC running from LFXO	—	2.8	—	μA
		Full 512 kB RAM retention and RTCC running from LFRCO	—	3.1	—	μA
		16 kB (1 bank) RAM retention and RTCC running from LFRCO ⁵	—	2.1	—	μA
Current consumption in EM3 mode, with voltage scaling enabled	I _{EM3_VS}	Full 512 kB RAM retention and CRYOTIMER running from ULFR-CO	—	2.4	—	μA

Parameter	Symbol	Test Condition	Min	Typ	Max	Unit
Current consumption in EM4H mode, with voltage scaling enabled	I _{EM4H_VS}	128 byte RAM retention, RTCC running from LFXO	—	0.94	—	μA
		128 byte RAM retention, CRYO-TIMER running from ULFRCO	—	0.62	—	μA
		128 byte RAM retention, no RTCC	—	0.62	—	μA
Current consumption in EM4S mode	I _{EM4S}	No RAM retention, no RTCC	—	0.13	—	μA
Current consumption of peripheral power domain 1, with voltage scaling enabled, DCDC in LP mode ³	I _{PD1_VS}	Additional current consumption in EM2/3 when any peripherals on power domain 1 are enabled ⁴	—	0.68	—	μA
Current consumption of peripheral power domain 2, with voltage scaling enabled, DCDC in LP mode ³	I _{PD2_VS}	Additional current consumption in EM2/3 when any peripherals on power domain 2 are enabled ⁴	—	0.28	—	μA

Note:

1. DCDC Low Noise CCM Mode = Light Drive (PFETCNT=NFETCNT=3), F=6.4 MHz (RCOBAND=4), ANASW=DVDD.
2. DCDC Low Noise DCM Mode = Light Drive (PFETCNT=NFETCNT=3), F=3.0 MHz (RCOBAND=0), ANASW=DVDD.
3. DCDC Low Power Mode = Medium Drive (PFETCNT=NFETCNT=7), LPOSCDIV=1, LPCMPBIASEM234H=0, LPCLIMILIMSEL=1, ANASW=DVDD.
4. Extra current consumed by power domain. Does not include current associated with the enabled peripherals. See [3.2.4 EM2 and EM3 Power Domains](#) for a list of the peripherals in each power domain.
5. CMU_LFRCOCTRL_ENVREF = 1, CMU_LFRCOCTRL_VREFUPDATE = 1

4.1.7.3 Current Consumption 1.8 V without DC-DC Converter

Unless otherwise indicated, typical conditions are: VREGVDD = AVDD = DVDD = 1.8 V. T = 25 °C. DCDC is off. Minimum and maximum values in this table represent the worst conditions across process variation at T = 25 °C.

Table 4.9. Current Consumption 1.8 V without DC-DC Converter

Parameter	Symbol	Test Condition	Min	Typ	Max	Unit
Current consumption in EM0 mode with all peripherals disabled	I _{ACTIVE}	72 MHz HFRCO, CPU running Prime from flash	—	120	—	μA/MHz
		72 MHz HFRCO, CPU running while loop from flash	—	120	—	μA/MHz
		72 MHz HFRCO, CPU running CoreMark loop from flash	—	140	—	μA/MHz
		50 MHz crystal, CPU running while loop from flash	—	122	—	μA/MHz
		48 MHz HFRCO, CPU running while loop from flash	—	122	—	μA/MHz
		32 MHz HFRCO, CPU running while loop from flash	—	124	—	μA/MHz
		26 MHz HFRCO, CPU running while loop from flash	—	126	—	μA/MHz
		16 MHz HFRCO, CPU running while loop from flash	—	131	—	μA/MHz
		1 MHz HFRCO, CPU running while loop from flash	—	315	—	μA/MHz
Current consumption in EM0 mode with all peripherals disabled and voltage scaling enabled	I _{ACTIVE_VS}	19 MHz HFRCO, CPU running while loop from flash	—	107	—	μA/MHz
		1 MHz HFRCO, CPU running while loop from flash	—	259	—	μA/MHz
Current consumption in EM1 mode with all peripherals disabled	I _{EM1}	72 MHz HFRCO	—	57	—	μA/MHz
		50 MHz crystal	—	59	—	μA/MHz
		48 MHz HFRCO	—	59	—	μA/MHz
		32 MHz HFRCO	—	61	—	μA/MHz
		26 MHz HFRCO	—	63	—	μA/MHz
		16 MHz HFRCO	—	68	—	μA/MHz
		1 MHz HFRCO	—	252	—	μA/MHz
Current consumption in EM1 mode with all peripherals disabled and voltage scaling enabled	I _{EM1_VS}	19 MHz HFRCO	—	55	—	μA/MHz
		1 MHz HFRCO	—	207	—	μA/MHz
Current consumption in EM2 mode, with voltage scaling enabled	I _{EM2_VS}	Full 512 kB RAM retention and RTCC running from LFXO	—	3.7	—	μA
		Full 512 kB RAM retention and RTCC running from LFRCO	—	4.0	—	μA
		16 kB (1 bank) RAM retention and RTCC running from LFRCO ²	—	2.5	—	μA

Parameter	Symbol	Test Condition	Min	Typ	Max	Unit
Current consumption in EM3 mode, with voltage scaling enabled	I_{EM3_VS}	Full 512 kB RAM retention and CRYOTIMER running from ULFRCO	—	3.4	—	μA
Current consumption in EM4H mode, with voltage scaling enabled	I_{EM4H_VS}	128 byte RAM retention, RTCC running from LFXO	—	0.94	—	μA
		128 byte RAM retention, CRYOTIMER running from ULFRCO	—	0.56	—	μA
		128 byte RAM retention, no RTCC	—	0.56	—	μA
Current consumption in EM4S mode	I_{EM4S}	No RAM retention, no RTCC	—	0.1	—	μA
Current consumption of peripheral power domain 1, with voltage scaling enabled	I_{PD1_VS}	Additional current consumption in EM2/3 when any peripherals on power domain 1 are enabled ¹	—	0.68	—	μA
Current consumption of peripheral power domain 2, with voltage scaling enabled	I_{PD2_VS}	Additional current consumption in EM2/3 when any peripherals on power domain 2 are enabled ¹	—	0.28	—	μA

Note:

1. Extra current consumed by power domain. Does not include current associated with the enabled peripherals. See [3.2.4 EM2 and EM3 Power Domains](#) for a list of the peripherals in each power domain.
2. CMU_LFRCTRL_ENVREF = 1, CMU_LFRCTRL_VREFUPDATE = 1

4.1.8 Wake Up Times

Table 4.10. Wake Up Times

Parameter	Symbol	Test Condition	Min	Typ	Max	Unit
Wake up time from EM1	t_{EM1_WU}		—	3	—	AHB Clocks
Wake up from EM2	t_{EM2_WU}	Code execution from flash	—	11.8	—	μs
		Code execution from RAM	—	4.1	—	μs
Wake up from EM3	t_{EM3_WU}	Code execution from flash	—	11.8	—	μs
		Code execution from RAM	—	4.1	—	μs
Wake up from EM4H ¹	t_{EM4H_WU}	Executing from flash	—	94	—	μs
Wake up from EM4S ¹	t_{EM4S_WU}	Executing from flash	—	294	—	μs
Time from release of reset source to first instruction execution	t_{RESET}	Soft Pin Reset released	—	55	—	μs
		Any other reset released	—	359	—	μs
Power mode scaling time	t_{SCALE}	VSCALE0 to VSCALE2, HFCLK = 19 MHz ⁴ ²	—	31.8	—	μs
		VSCALE2 to VSCALE0, HFCLK = 19 MHz ³	—	4.3	—	μs

Note:

1. Time from wake up request until first instruction is executed. Wakeup results in device reset.
2. VSCALE0 to VSCALE2 voltage change transitions occur at a rate of 10 mV/ μs for approximately 20 μs . During this transition, peak currents will be dependent on the value of the DECOUPLE output capacitor, from 35 mA (with a 1 μF capacitor) to 70 mA (with a 2.7 μF capacitor).
3. Scaling down from VSCALE2 to VSCALE0 requires approximately 2.8 μs + 29 HFCLKs.
4. Scaling up from VSCALE0 to VSCALE2 requires approximately 30.3 μs + 28 HFCLKs.

4.1.9 Brown Out Detector (BOD)

Table 4.11. Brown Out Detector (BOD)

Parameter	Symbol	Test Condition	Min	Typ	Max	Unit
DVDD BOD threshold	V _{DVddbod}	DVDD rising	—	—	1.62	V
		DVDD falling (EM0/EM1)	1.35	—	—	V
		DVDD falling (EM2/EM3)	1.3	—	—	V
DVDD BOD hysteresis	V _{DVddbod_hyst}		—	18	—	mV
DVDD BOD response time	t _{DVddbod_delay}	Supply drops at 0.1V/μs rate	—	2.4	—	μs
AVDD BOD threshold	V _{AVddbod}	AVDD rising	—	—	1.8	V
		AVDD falling (EM0/EM1)	1.62	—	—	V
		AVDD falling (EM2/EM3)	1.53	—	—	V
AVDD BOD hysteresis	V _{AVddbod_hyst}		—	20	—	mV
AVDD BOD response time	t _{AVddbod_delay}	Supply drops at 0.1V/μs rate	—	2.4	—	μs
EM4 BOD threshold	V _{EM4dbod}	AVDD rising	—	—	1.7	V
		AVDD falling	1.45	—	—	V
EM4 BOD hysteresis	V _{EM4bod_hyst}		—	25	—	mV
EM4 BOD response time	t _{EM4bod_delay}	Supply drops at 0.1V/μs rate	—	300	—	μs

4.1.10 Oscillators

4.1.10.1 Low-Frequency Crystal Oscillator (LFXO)

Table 4.12. Low-Frequency Crystal Oscillator (LFXO)

Parameter	Symbol	Test Condition	Min	Typ	Max	Unit
Crystal frequency	f_{LFXO}		—	32.768	—	kHz
Supported crystal equivalent series resistance (ESR)	ESR_{LFXO}		—	—	70	k Ω
Supported range of crystal load capacitance ¹	C_{LFXO_CL}		6	—	18	pF
On-chip tuning cap range ²	C_{LFXO_T}	On each of LFX TAL_N and LFX TAL_P pins	8	—	40	pF
On-chip tuning cap step size	SS_{LFXO}		—	0.25	—	pF
Current consumption after startup ³	I_{LFXO}	ESR = 70 k Ω , C_L = 7 pF, GAIN ⁴ = 2, AGC ⁴ = 1	—	273	—	nA
Start-up time	t_{LFXO}	ESR = 70 k Ω , C_L = 7 pF, GAIN ⁴ = 2	—	308	—	ms

Note:

1. Total load capacitance as seen by the crystal.
2. The effective load capacitance seen by the crystal will be $C_{LFXO_T} / 2$. This is because each XTAL pin has a tuning cap and the two caps will be seen in series by the crystal.
3. Block is supplied by AVDD if ANASW = 0, or DVDD if ANASW=1 in EMU_PWRCTRL register.
4. In CMU_LFXOCTRL register.

4.1.10.2 High-Frequency Crystal Oscillator (HFXO)

Table 4.13. High-Frequency Crystal Oscillator (HFXO)

Parameter	Symbol	Test Condition	Min	Typ	Max	Unit
Crystal frequency	f_{HFXO}	No clock doubling	4	—	50	MHz
		Clock doubler enabled	4	—	25	MHz
Supported crystal equivalent series resistance (ESR)	ESR_{HFXO}	50 MHz crystal	—	—	50	Ω
		24 MHz crystal	—	—	150	Ω
		4 MHz crystal	—	—	180	Ω
Nominal on-chip tuning cap range ¹	$C_{\text{HFXO_T}}$	On each of HFXTAL_N and HFXTAL_P pins	8.7	—	51.7	pF
On-chip tuning capacitance step	SS_{HFXO}		—	0.084	—	pF
Startup time	t_{HFXO}	50 MHz crystal, ESR = 50 Ohm, $C_L = 8$ pF	—	350	—	μs
		24 MHz crystal, ESR = 150 Ohm, $C_L = 6$ pF	—	700	—	μs
		4 MHz crystal, ESR = 180 Ohm, $C_L = 18$ pF	—	3	—	ms
Current consumption after startup	I_{HFXO}	50 MHz crystal	—	880	—	μA
		24 MHz crystal	—	420	—	μA
		4 MHz crystal	—	80	—	μA

Note:

1. The effective load capacitance seen by the crystal will be $C_{\text{HFXO_T}}/2$. This is because each XTAL pin has a tuning cap and the two caps will be seen in series by the crystal.

4.1.10.3 Low-Frequency RC Oscillator (LFRCO)

Table 4.14. Low-Frequency RC Oscillator (LFRCO)

Parameter	Symbol	Test Condition	Min	Typ	Max	Unit
Oscillation frequency	f_{LFRCO}	ENVREF ² = 1, T ≤ 85 °C	31.3	32.768	33.6	kHz
		ENVREF ² = 1, T > 85 °C	31	32.768	36.8	kHz
		ENVREF ² = 0, T ≤ 85 °C	31.3	32.768	33.4	kHz
		ENVREF ² = 0, T > 85 °C	30	32.768	33.6	kHz
Startup time	t_{LFRCO}		—	500	—	μs
Current consumption ¹	I_{LFRCO}	ENVREF = 1 in CMU_LFRCOCTRL	—	370	—	nA
		ENVREF = 0 in CMU_LFRCOCTRL	—	520	—	nA
<p>Note:</p> <p>1. Block is supplied by AVDD if ANASW = 0, or DVDD if ANASW=1 in EMU_PWRCTRL register.</p> <p>2. In CMU_LFRCOCTRL register.</p>						

4.1.10.4 High-Frequency RC Oscillator (HFRCO)

Table 4.15. High-Frequency RC Oscillator (HFRCO)

Parameter	Symbol	Test Condition	Min	Typ	Max	Unit
Frequency accuracy	$f_{\text{HFRCO_ACC}}$	At production calibrated frequencies, across supply voltage and temperature	-2.5	—	2.5	%
Start-up time	t_{HFRCO}	$f_{\text{HFRCO}} \geq 19 \text{ MHz}$	—	300	—	ns
		$4 < f_{\text{HFRCO}} < 19 \text{ MHz}$	—	1	—	μs
		$f_{\text{HFRCO}} \leq 4 \text{ MHz}$	—	2.5	—	μs
Maximum DPLL lock time ¹	$t_{\text{DPLL_LOCK}}$	$f_{\text{REF}} = 32.768 \text{ kHz}$, $f_{\text{HFRCO}} = 39.98 \text{ MHz}$, $N = 1219$, $M = 0$	—	183	—	μs
Current consumption on all supplies	I_{HFRCO}	$f_{\text{HFRCO}} = 72 \text{ MHz}$	—	610	690	μA
		$f_{\text{HFRCO}} = 64 \text{ MHz}$	—	550	615	μA
		$f_{\text{HFRCO}} = 56 \text{ MHz}$	—	482	535	μA
		$f_{\text{HFRCO}} = 48 \text{ MHz}$	—	413	470	μA
		$f_{\text{HFRCO}} = 38 \text{ MHz}$	—	341	390	μA
		$f_{\text{HFRCO}} = 32 \text{ MHz}$	—	286	330	μA
		$f_{\text{HFRCO}} = 26 \text{ MHz}$	—	240	275	μA
		$f_{\text{HFRCO}} = 19 \text{ MHz}$	—	191	220	μA
		$f_{\text{HFRCO}} = 16 \text{ MHz}$	—	164	200	μA
		$f_{\text{HFRCO}} = 13 \text{ MHz}$	—	144	180	μA
		$f_{\text{HFRCO}} = 7 \text{ MHz}$	—	103	130	μA
		$f_{\text{HFRCO}} = 4 \text{ MHz}$	—	42	60	μA
		$f_{\text{HFRCO}} = 2 \text{ MHz}$	—	33	43	μA
		$f_{\text{HFRCO}} = 1 \text{ MHz}$	—	28	38	μA
		$f_{\text{HFRCO}} = 72 \text{ MHz}$, DPLL enabled	—	930	1200	μA
		$f_{\text{HFRCO}} = 40 \text{ MHz}$, DPLL enabled	—	526	700	μA
		$f_{\text{HFRCO}} = 32 \text{ MHz}$, DPLL enabled	—	419	520	μA
		$f_{\text{HFRCO}} = 16 \text{ MHz}$, DPLL enabled	—	233	280	μA
$f_{\text{HFRCO}} = 4 \text{ MHz}$, DPLL enabled	—	60	100	μA		
$f_{\text{HFRCO}} = 1 \text{ MHz}$, DPLL enabled	—	36	60	μA		
Coarse trim step size (% of period)	$SS_{\text{HFRCO_COARSE}}$		—	0.8	—	%
Fine trim step size (% of period)	$SS_{\text{HFRCO_FINE}}$		—	0.1	—	%
Period jitter	PJ_{HFRCO}		—	0.2	—	% RMS

Parameter	Symbol	Test Condition	Min	Typ	Max	Unit
Frequency limits	f _{HFRCO_BAND}	FREQRANGE = 0, FINETUNINGEN = 0	1	—	10	MHz
		FREQRANGE = 3, FINETUNINGEN = 0	2	—	17	MHz
		FREQRANGE = 6, FINETUNINGEN = 0	4	—	30	MHz
		FREQRANGE = 7, FINETUNINGEN = 0	5	—	34	MHz
		FREQRANGE = 8, FINETUNINGEN = 0	7	—	42	MHz
		FREQRANGE = 10, FINETUNINGEN = 0	12	—	58	MHz
		FREQRANGE = 11, FINETUNINGEN = 0	15	—	68	MHz
		FREQRANGE = 12, FINETUNINGEN = 0	18	—	83	MHz
		FREQRANGE = 13, FINETUNINGEN = 0	24	—	100	MHz
		FREQRANGE = 14, FINETUNINGEN = 0	28	—	119	MHz
		FREQRANGE = 15, FINETUNINGEN = 0	33	—	138	MHz
		FREQRANGE = 16, FINETUNINGEN = 0	43	—	163	MHz

Note:

1. Maximum DPLL lock time $\sim 6 \times (M+1) \times t_{REF}$, where t_{REF} is the reference clock period.

4.1.10.5 Auxiliary High-Frequency RC Oscillator (AUXHFRCO)

Table 4.16. Auxiliary High-Frequency RC Oscillator (AUXHFRCO)

Parameter	Symbol	Test Condition	Min	Typ	Max	Unit
Frequency accuracy	$f_{\text{AUXHFRCO_ACC}}$	At production calibrated frequencies, across supply voltage and temperature	-3	—	3	%
Start-up time	t_{AUXHFRCO}	$f_{\text{AUXHFRCO}} \geq 19 \text{ MHz}$	—	400	—	ns
		$4 < f_{\text{AUXHFRCO}} < 19 \text{ MHz}$	—	1.4	—	μs
		$f_{\text{AUXHFRCO}} \leq 4 \text{ MHz}$	—	2.5	—	μs
Current consumption on all supplies	I_{AUXHFRCO}	$f_{\text{AUXHFRCO}} = 50 \text{ MHz}$	—	289	335	μA
		$f_{\text{AUXHFRCO}} = 48 \text{ MHz}$	—	276	320	μA
		$f_{\text{AUXHFRCO}} = 38 \text{ MHz}$	—	227	265	μA
		$f_{\text{AUXHFRCO}} = 32 \text{ MHz}$	—	186	220	μA
		$f_{\text{AUXHFRCO}} = 26 \text{ MHz}$	—	158	190	μA
		$f_{\text{AUXHFRCO}} = 19 \text{ MHz}$	—	126	160	μA
		$f_{\text{AUXHFRCO}} = 16 \text{ MHz}$	—	114	140	μA
		$f_{\text{AUXHFRCO}} = 13 \text{ MHz}$	—	88	112	μA
		$f_{\text{AUXHFRCO}} = 7 \text{ MHz}$	—	59	72	μA
		$f_{\text{AUXHFRCO}} = 4 \text{ MHz}$	—	33	42	μA
		$f_{\text{AUXHFRCO}} = 2 \text{ MHz}$	—	28	37	μA
$f_{\text{AUXHFRCO}} = 1 \text{ MHz}$	—	26	33	μA		
Coarse trim step size (% of period)	$SS_{\text{AUXHFRCO_COARSE}}$		—	0.8	—	%
Fine trim step size (% of period)	$SS_{\text{AUXHFRCO_FINE}}$		—	0.1	—	%
Period jitter	PJ_{AUXHFRCO}		—	0.2	—	% RMS

4.1.10.6 Universal High-Frequency RC Oscillator (USHFRCO)

Table 4.17. Universal High-Frequency RC Oscillator (USHFRCO)

Parameter	Symbol	Test Condition	Min	Typ	Max	Unit
Frequency accuracy	f _{USHFRCO_ACC}	At production calibrated frequencies, across supply voltage and temperature	-2.5	—	2.5	%
		USB clock recovery enabled, Active connection as device, FINE-TUNINGEN ¹ = 1	-0.25	—	0.25	%
Start-up time	t _{USHFRCO}		—	300	—	ns
Current consumption on all supplies	I _{USHFRCO}	f _{USHFRCO} = 48 MHz, FINETUNINGEN ¹ = 1	—	340	400	μA
		f _{USHFRCO} = 50 MHz, FINETUNINGEN ¹ = 0	—	320	380	μA
		f _{USHFRCO} = 48 MHz, FINETUNINGEN ¹ = 0	—	300	370	μA
		f _{USHFRCO} = 32 MHz, FINETUNINGEN ¹ = 0	—	200	240	μA
		f _{USHFRCO} = 16 MHz, FINETUNINGEN ¹ = 0	—	120	160	μA
Period jitter	PJ _{USHFRCO}		—	0.2	—	% RMS
Note: 1. In the CMU_USHFRCOCTRL register.						

4.1.10.7 Ultra-low Frequency RC Oscillator (ULFRCO)

Table 4.18. Ultra-low Frequency RC Oscillator (ULFRCO)

Parameter	Symbol	Test Condition	Min	Typ	Max	Unit
Oscillation frequency	f _{ULFRCO}		0.88	1	1.12	kHz

4.1.11 Flash Memory Characteristics⁵

Table 4.19. Flash Memory Characteristics⁵

Parameter	Symbol	Test Condition	Min	Typ	Max	Unit
Flash erase cycles before failure	EC _{FLASH}		10000	—	—	cycles
Flash data retention	RET _{FLASH}	T ≤ 85 °C	10	—	—	years
		T ≤ 125 °C	10	—	—	years
Word (32-bit) programming time	t _{W_PROG}	Burst write, 128 words, average time per word	20	26.2	32	µs
		Single word	59	68.7	83	µs
Page erase time ⁴	t _{PERASE}		20	26.8	35	ms
Mass erase time ¹	t _{MERASE}		20	26.9	35	ms
Device erase time ^{2 3}	t _{DERASE}	T ≤ 85 °C	—	80.7	95	ms
		T ≤ 125 °C	—	80.7	100	ms
Erase current ⁶	I _{ERASE}	Page Erase	—	—	1.7	mA
		Mass or Device Erase	—	—	2.1	mA
Write current ⁶	I _{WRITE}		—	—	3.9	mA
Supply voltage during flash erase and write	V _{FLASH}		1.62	—	3.6	V

Note:

1. Mass erase is issued by the CPU and erases all flash.
2. Device erase is issued over the AAP interface and erases all flash, SRAM, the Lock Bit (LB) page, and the User data page Lock Word (ULW).
3. From setting the DEVICEERASE bit in AAP_CMD to 1 until the ERASEBUSY bit in AAP_STATUS is cleared to 0. Internal setup and hold times for flash control signals are included.
4. From setting the ERASEPAGE bit in MSC_WRITECMD to 1 until the BUSY bit in MSC_STATUS is cleared to 0. Internal setup and hold times for flash control signals are included.
5. Flash data retention information is published in the Quarterly Quality and Reliability Report.
6. Measured at 25 °C.

4.1.12 General-Purpose I/O (GPIO)

Table 4.20. General-Purpose I/O (GPIO)

Parameter	Symbol	Test Condition	Min	Typ	Max	Unit
Input low voltage ¹	V _{IL}	GPIO pins	—	—	IOVDD*0.3	V
		RESETE _n	—	—	AVDD*0.3	V
Input high voltage ¹	V _{IH}	GPIO pins	IOVDD*0.7	—	—	V
		RESETE _n	AVDD*0.7	—	—	V
Output high voltage relative to IOVDD	V _{OH}	Sourcing 3 mA, IOVDD ≥ 3 V, DRIVESTRENGTH ² = WEAK	IOVDD*0.8	—	—	V
		Sourcing 1.2 mA, IOVDD ≥ 1.62 V, DRIVESTRENGTH ² = WEAK	IOVDD*0.6	—	—	V
		Sourcing 20 mA, IOVDD ≥ 3 V, DRIVESTRENGTH ² = STRONG	IOVDD*0.8	—	—	V
		Sourcing 8 mA, IOVDD ≥ 1.62 V, DRIVESTRENGTH ² = STRONG	IOVDD*0.6	—	—	V
Output low voltage relative to IOVDD	V _{OL}	Sinking 3 mA, IOVDD ≥ 3 V, DRIVESTRENGTH ² = WEAK	—	—	IOVDD*0.2	V
		Sinking 1.2 mA, IOVDD ≥ 1.62 V, DRIVESTRENGTH ² = WEAK	—	—	IOVDD*0.4	V
		Sinking 20 mA, IOVDD ≥ 3 V, DRIVESTRENGTH ² = STRONG	—	—	IOVDD*0.2	V
		Sinking 8 mA, IOVDD ≥ 1.62 V, DRIVESTRENGTH ² = STRONG	—	—	IOVDD*0.4	V
Input leakage current	I _{IOLEAK}	All GPIO except BUVIN, LFXO, and USB pins, GPIO ≤ IOVDD, T ≤ 85 °C	—	0.1	40	nA
		BUVIN, LFXO, and USB pins, GPIO ≤ IOVDD, T ≤ 85 °C	—	0.1	60	nA
		All GPIO except BUVIN, LFXO, and USB pins, GPIO ≤ IOVDD, T > 85 °C	—	—	150	nA
		BUVIN, LFXO, and USB pins, GPIO ≤ IOVDD, T > 85 °C	—	—	300	nA
Input leakage current on 5VTOL pads above IOVDD	I _{5VTOLLEAK}	IOVDD < GPIO ≤ IOVDD + 2 V	—	3.3	15	μA
Pull-up/down resistance ³	R _{PUD}	Any GPIO pin	30	40	65	kΩ
		RESETE _n pin				

Parameter	Symbol	Test Condition	Min	Typ	Max	Unit
Pulse width of pulses removed by the glitch suppression filter	$t_{IOGLITCH}$		15	25	35	ns
Output fall time, From 70% to 30% of V_{IO}	t_{IOOF}	$C_L = 50$ pF, DRIVESTRENGTH ² = STRONG, SLEWRATE ² = 0x6	—	1.8	—	ns
		$C_L = 50$ pF, DRIVESTRENGTH ² = WEAK, SLEWRATE ² = 0x6	—	4.5	—	ns
Output rise time, From 30% to 70% of V_{IO}	t_{IOOR}	$C_L = 50$ pF, DRIVESTRENGTH ² = STRONG, SLEWRATE = 0x6 ²	—	2.2	—	ns
		$C_L = 50$ pF, DRIVESTRENGTH ² = WEAK, SLEWRATE ² = 0x6	—	7.4	—	ns
Required external series resistor on USB D+ and D-	R_{USB}		—	33 +/-10%	—	Ω
RESETn low time to ensure pin reset	T_{RESET}		100	—	—	ns

Note:

1. GPIO input thresholds are proportional to the IOVDD supply, except for RESETn, which is proportional to AVDD (or BU_VIN in backup mode).
2. In GPIO_Pn_CTRL register.
3. GPIO pull-ups connect to IOVDD; pull-downs connect to VSS. The RESETn pull-up connects to AVDD (or BU_VIN in backup mode).

4.1.13 Voltage Monitor (VMON)

Table 4.21. Voltage Monitor (VMON)

Parameter	Symbol	Test Condition	Min	Typ	Max	Unit
Supply current (including I _{SENSE})	I _{VMON}	In EM0 or EM1, 1 supply monitored, T ≤ 85 °C	—	6	11	μA
		In EM0 or EM1, 1 supply monitored, T > 85 °C	—	—	21	μA
		In EM0 or EM1, 4 supplies monitored, T ≤ 85 °C	—	15	20	μA
		In EM0 or EM1, 4 supplies monitored, T > 85 °C	—	—	32	μA
		In EM2, EM3 or EM4, 1 supply monitored and above threshold	—	62	—	nA
		In EM2, EM3 or EM4, 1 supply monitored and below threshold	—	62	—	nA
		In EM2, EM3 or EM4, 4 supplies monitored and all above threshold	—	99	—	nA
		In EM2, EM3 or EM4, 4 supplies monitored and all below threshold	—	99	—	nA
Loading of monitored supply	I _{SENSE}	In EM0 or EM1	—	2	—	μA
		In EM2, EM3 or EM4	—	2	—	nA
Threshold range	V _{VMON_RANGE}		1.62	—	3.4	V
Threshold step size	N _{VMON_STESP}	Coarse	—	200	—	mV
		Fine	—	20	—	mV
Response time	t _{VMON_RES}	Supply drops at 1V/μs rate	—	460	—	ns
Hysteresis	V _{VMON_HYST}		—	26	—	mV

4.1.14 Analog to Digital Converter (ADC)

Specified at 1 Msps, ADCCLK = 16 MHz, BIASPROG = 0, GPBIASACC = 0, unless otherwise indicated.

Table 4.22. Analog to Digital Converter (ADC)

Parameter	Symbol	Test Condition	Min	Typ	Max	Unit
Resolution	$V_{RESOLUTION}$		6	—	12	Bits
Input voltage range ⁵	V_{ADCIN}	Single ended	—	—	V_{FS}	V
		Differential	$-V_{FS}/2$	—	$V_{FS}/2$	V
Input range of external reference voltage, single ended and differential	$V_{ADCREFIN_P}$		1	—	V_{AVDD}	V
Power supply rejection ²	$PSRR_{ADC}$	At DC	—	80	—	dB
Analog input common mode rejection ratio	$CMRR_{ADC}$	At DC	—	80	—	dB
Current from all supplies, using internal reference buffer. Continuous operation. $WAR_MUPMODE^4 = KEEPADC_WARM$	$I_{ADC_CONTINUOUS_LP}$	1 Msps / 16 MHz ADCCLK, BIASPROG = 0, GPBIASACC = 1 ³	—	270	350	μA
		250 ksps / 4 MHz ADCCLK, BIASPROG = 6, GPBIASACC = 1 ³	—	125	—	μA
		62.5 ksps / 1 MHz ADCCLK, BIASPROG = 15, GPBIASACC = 1 ³	—	80	—	μA
Current from all supplies, using internal reference buffer. Duty-cycled operation. $WAR_MUPMODE^4 = NORMAL$	$I_{ADC_NORMAL_LP}$	35 ksps / 16 MHz ADCCLK, BIASPROG = 0, GPBIASACC = 1 ³	—	45	—	μA
		5 ksps / 16 MHz ADCCLK BIASPROG = 0, GPBIASACC = 1 ³	—	8	—	μA
Current from all supplies, using internal reference buffer. Duty-cycled operation. $AWARMUPMODE^4 = KEEPINSTANDBY$ or $KEEPIN_SLOWACC$	$I_{ADC_STANDBY_LP}$	125 ksps / 16 MHz ADCCLK, BIASPROG = 0, GPBIASACC = 1 ³	—	105	—	μA
		35 ksps / 16 MHz ADCCLK, BIASPROG = 0, GPBIASACC = 1 ³	—	70	—	μA
Current from all supplies, using internal reference buffer. Continuous operation. $WAR_MUPMODE^4 = KEEPADC_WARM$	$I_{ADC_CONTINUOUS_HP}$	1 Msps / 16 MHz ADCCLK, BIASPROG = 0, GPBIASACC = 0 ³	—	325	—	μA
		250 ksps / 4 MHz ADCCLK, BIASPROG = 6, GPBIASACC = 0 ³	—	175	—	μA
		62.5 ksps / 1 MHz ADCCLK, BIASPROG = 15, GPBIASACC = 0 ³	—	125	—	μA
Current from all supplies, using internal reference buffer. Duty-cycled operation. $WAR_MUPMODE^4 = NORMAL$	$I_{ADC_NORMAL_HP}$	35 ksps / 16 MHz ADCCLK, BIASPROG = 0, GPBIASACC = 0 ³	—	85	—	μA
		5 ksps / 16 MHz ADCCLK BIASPROG = 0, GPBIASACC = 0 ³	—	16	—	μA
Current from all supplies, using internal reference buffer. Duty-cycled operation. $AWARMUPMODE^4 = KEEPINSTANDBY$ or $KEEPIN_SLOWACC$	$I_{ADC_STANDBY_HP}$	125 ksps / 16 MHz ADCCLK, BIASPROG = 0, GPBIASACC = 0 ³	—	160	—	μA
		35 ksps / 16 MHz ADCCLK, BIASPROG = 0, GPBIASACC = 0 ³	—	125	—	μA
Current from HFPERCLK	I_{ADC_CLK}	HFPERCLK = 16 MHz	—	180	—	μA

Parameter	Symbol	Test Condition	Min	Typ	Max	Unit
ADC clock frequency	f_{ADCCLK}		—	—	16	MHz
Throughput rate	f_{ADCRATE}		—	—	1	Msp/s
Conversion time ¹	t_{ADCCONV}	6 bit	—	7	—	cycles
		8 bit	—	9	—	cycles
		12 bit	—	13	—	cycles
Startup time of reference generator and ADC core	t_{ADCSTART}	WARMUPMODE ⁴ = NORMAL	—	—	5	μs
		WARMUPMODE ⁴ = KEEPIN-STANDBY	—	—	2	μs
		WARMUPMODE ⁴ = KEEPINSLOWACC	—	—	1	μs
SNDR at 1Msp/s and $f_{\text{IN}} = 10\text{kHz}$	SNDR _{ADC}	Internal reference ⁷ , differential measurement	58	67	—	dB
		External reference ⁶ , differential measurement	—	68	—	dB
Spurious-free dynamic range (SFDR)	SFDR _{ADC}	1 MSamples/s, 10 kHz full-scale sine wave	—	75	—	dB
Differential non-linearity (DNL)	DNL _{ADC}	12 bit resolution, No missing codes	-1	—	2	LSB
Integral non-linearity (INL), End point method	INL _{ADC}	12 bit resolution	-6	—	6	LSB
Offset error	$V_{\text{ADCOFFSETERR}}$		-3	0	3	LSB
Gain error in ADC	V_{ADCGAIN}	Using internal reference	—	-0.2	3.5	%
		Using external reference	—	-1	—	%
Temperature sensor slope	$V_{\text{TS_SLOPE}}$		—	-1.84	—	mV/°C

Note:

- Derived from ADCCLK.
- PSRR is referenced to AVDD when ANASW=0 and to DVDD when ANASW=1 in EMU_PWRCTRL.
- In ADCn_BIASPROG register.
- In ADCn_CNTL register.
- The absolute voltage allowed at any ADC input is dictated by the power rail supplied to on-chip circuitry, and may be lower than the effective full scale voltage. All ADC inputs are limited to the ADC supply (AVDD or DVDD depending on EMU_PWRCTRL_ANASW). Any ADC input routed through the APORT will further be limited by the IOVDD supply to the pin.
- External reference is 1.25 V applied externally to ADCnEXTREFP, with the selection CONF in the SINGLECTRL_REF or SCANCTRL_REF register field and VREFP in the SINGLECTRLX_VREFSEL or SCANCTRLX_VREFSEL field. The differential input range with this configuration is $\pm 1.25\text{ V}$.
- Internal reference option used corresponds to selection 2V5 in the SINGLECTRL_REF or SCANCTRL_REF register field. The differential input range with this configuration is $\pm 1.25\text{ V}$. Typical value is characterized using full-scale sine wave input. Minimum value is production-tested using sine wave input at 1.5 dB lower than full scale.

4.1.15 Analog Comparator (ACMP)

Table 4.23. Analog Comparator (ACMP)

Parameter	Symbol	Test Condition	Min	Typ	Max	Unit
Input voltage range	V_{ACMPIN}	ACMPVDD = ACMPn_CTRL_PWRSEL ¹	—	—	$V_{ACMPVDD}$	V
Supply voltage	$V_{ACMPVDD}$	BIASPROG ⁴ ≤ 0x10 or FULL- BIAS ⁴ = 0	1.8	—	$V_{VREGVDD_MAX}$	V
		0x10 < BIASPROG ⁴ ≤ 0x20 and FULLBIAS ⁴ = 1	2.1	—	$V_{VREGVDD_MAX}$	V
Active current not including voltage reference ²	I_{ACMP}	BIASPROG ⁴ = 1, FULLBIAS ⁴ = 0	—	50	—	nA
		BIASPROG ⁴ = 0x10, FULLBIAS ⁴ = 0	—	306	—	nA
		BIASPROG ⁴ = 0x02, FULLBIAS ⁴ = 1	—	6.5	—	μA
		BIASPROG ⁴ = 0x20, FULLBIAS ⁴ = 1	—	74	100	μA
Current consumption of inter- nal voltage reference ²	$I_{ACMPREF}$	VLP selected as input using 2.5 V Reference / 4 (0.625 V)	—	50	—	nA
		VLP selected as input using VDD	—	20	—	nA
		VBDIV selected as input using 1.25 V reference / 1	—	4.1	—	μA
		VADIV selected as input using VDD/1	—	2.4	—	μA

Parameter	Symbol	Test Condition	Min	Typ	Max	Unit
Hysteresis ($V_{CM} = 1.25\text{ V}$, $BIASPROG^4 = 0x10$, $FULLBIAS^4 = 1$)	$V_{ACMPHYST}$	$HYSTSEL^5 = HYST0$	-3	0	3	mV
		$HYSTSEL^5 = HYST1$	5	18	27	mV
		$HYSTSEL^5 = HYST2$	12	33	50	mV
		$HYSTSEL^5 = HYST3$	17	46	67	mV
		$HYSTSEL^5 = HYST4$	23	57	92	mV
		$HYSTSEL^5 = HYST5$	26	68	108	mV
		$HYSTSEL^5 = HYST6$	30	79	140	mV
		$HYSTSEL^5 = HYST7$	34	90	160	mV
		$HYSTSEL^5 = HYST8$	-3	0	3	mV
		$HYSTSEL^5 = HYST9$	-27	-18	-5	mV
		$HYSTSEL^5 = HYST10$	-50	-33	-12	mV
		$HYSTSEL^5 = HYST11$	-67	-45	-17	mV
		$HYSTSEL^5 = HYST12$	-92	-57	-23	mV
		$HYSTSEL^5 = HYST13$	-108	-67	-26	mV
		$HYSTSEL^5 = HYST14$	-140	-78	-30	mV
$HYSTSEL^5 = HYST15$	-160	-88	-34	mV		
Comparator delay ³	$t_{ACMPDELAY}$	$BIASPROG^4 = 1$, $FULLBIAS^4 = 0$	—	30	—	μs
		$BIASPROG^4 = 0x10$, $FULLBIAS^4 = 0$	—	3.7	—	μs
		$BIASPROG^4 = 0x02$, $FULLBIAS^4 = 1$	—	360	—	ns
		$BIASPROG^4 = 0x20$, $FULLBIAS^4 = 1$	—	35	—	ns
Offset voltage	$V_{ACMPOFFSET}$	$BIASPROG^4 = 0x10$, $FULLBIAS^4 = 1$	-35	—	35	mV
Reference voltage	$V_{ACMPREF}$	Internal 1.25 V reference	1	1.25	1.47	V
		Internal 2.5 V reference	1.98	2.5	2.8	V
Capacitive sense internal resistance	R_{CSRES}	$CSRESSEL^6 = 0$	—	infinite	—	k Ω
		$CSRESSEL^6 = 1$	—	15	—	k Ω
		$CSRESSEL^6 = 2$	—	27	—	k Ω
		$CSRESSEL^6 = 3$	—	39	—	k Ω
		$CSRESSEL^6 = 4$	—	51	—	k Ω
		$CSRESSEL^6 = 5$	—	100	—	k Ω
		$CSRESSEL^6 = 6$	—	162	—	k Ω
		$CSRESSEL^6 = 7$	—	235	—	k Ω

Parameter	Symbol	Test Condition	Min	Typ	Max	Unit
Note:						
1. ACMPVDD is a supply chosen by the setting in ACMPn_CTRL_PWRSEL and may be IOVDD, AVDD or DVDD.						
2. The total ACMP current is the sum of the contributions from the ACMP and its internal voltage reference. $I_{ACMPTOTAL} = I_{ACMP} + I_{ACMPREF}$.						
3. ± 100 mV differential drive.						
4. In ACMPn_CTRL register.						
5. In ACMPn_HYSTERESIS registers.						
6. In ACMPn_INPUTSEL register.						

4.1.16 Digital to Analog Converter (VDAC)

DRIVESTRENGTH = 2 unless otherwise specified. Primary VDAC output.

Table 4.24. Digital to Analog Converter (VDAC)

Parameter	Symbol	Test Condition	Min	Typ	Max	Unit
Output voltage	V_{DACOUT}	Single-Ended	0	—	V_{VREF}	V
		Differential ²	$-V_{VREF}$	—	V_{VREF}	V
Current consumption including references (2 channels) ¹	I_{DAC}	500 ksps, 12-bit, DRIVESTRENGTH = 2, REFSEL = 4	—	402	—	μA
		44.1 ksps, 12-bit, DRIVESTRENGTH = 1, REFSEL = 4	—	88	—	μA
		200 Hz refresh rate, 12-bit Sample-Off mode in EM2, DRIVESTRENGTH = 2, BGRREQTIME = 1, EM2REFENTIME = 9, REFSEL = 4, SETTLETIME = 0x0A, WARMUPTIME = 0x02	—	2	—	μA
Current from HFPERCLK ⁴	I_{DAC_CLK}		—	5.25	—	$\mu A/MHz$
Sample rate	SR_{DAC}		—	—	500	ksps
DAC clock frequency	f_{DAC}		—	—	1	MHz
Conversion time	$t_{DACCONV}$	$f_{DAC} = 1MHz$	2	—	—	μs
Settling time	$t_{DACSETTLE}$	50% fs step settling to 5 LSB	—	2.5	—	μs
Startup time	$t_{DACSTARTUP}$	Enable to 90% fs output, settling to 10 LSB	—	—	12	μs
Output impedance	R_{OUT}	DRIVESTRENGTH = 2, $0.4 V \leq V_{OUT} \leq V_{OPA} - 0.4 V$, $-8 mA < I_{OUT} < 8 mA$, Full supply range	—	2	—	Ω
		DRIVESTRENGTH = 0 or 1, $0.4 V \leq V_{OUT} \leq V_{OPA} - 0.4 V$, $-400 \mu A < I_{OUT} < 400 \mu A$, Full supply range	—	2	—	Ω
		DRIVESTRENGTH = 2, $0.1 V \leq V_{OUT} \leq V_{OPA} - 0.1 V$, $-2 mA < I_{OUT} < 2 mA$, Full supply range	—	2	—	Ω
		DRIVESTRENGTH = 0 or 1, $0.1 V \leq V_{OUT} \leq V_{OPA} - 0.1 V$, $-100 \mu A < I_{OUT} < 100 \mu A$, Full supply range	—	2	—	Ω
Power supply rejection ratio ⁶	PSRR	$V_{out} = 50\% fs, DC$	—	65.5	—	dB

Parameter	Symbol	Test Condition	Min	Typ	Max	Unit
Signal to noise and distortion ratio (1 kHz sine wave), Noise band limited to 250 kHz	SNDR _{DAC}	500 ksps, single-ended, internal 1.25V reference	—	60.4	—	dB
		500 ksps, single-ended, internal 2.5V reference	—	61.6	—	dB
		500 ksps, single-ended, 3.3V VDD reference	—	64.0	—	dB
		500 ksps, differential, internal 1.25V reference	—	63.3	—	dB
		500 ksps, differential, internal 2.5V reference	—	64.4	—	dB
		500 ksps, differential, 3.3V VDD reference	—	65.8	—	dB
Signal to noise and distortion ratio (1 kHz sine wave), Noise band limited to 22 kHz	SNDR _{DAC_BAND}	500 ksps, single-ended, internal 1.25V reference	—	65.3	—	dB
		500 ksps, single-ended, internal 2.5V reference	—	66.7	—	dB
		500 ksps, differential, 3.3V VDD reference	—	68.5	—	dB
		500 ksps, differential, internal 1.25V reference	—	67.8	—	dB
		500 ksps, differential, internal 2.5V reference	—	69.0	—	dB
		500 ksps, single-ended, 3.3V VDD reference	—	70.0	—	dB
Total harmonic distortion	THD		—	70.2	—	dB
Differential non-linearity ³	DNL _{DAC}		-1.25	—	1.25	LSB
Integral non-linearity	INL _{DAC}		-4	—	4	LSB
Offset error ⁵	V _{OFFSET}	T = 25 °C	-8	—	8	mV
		Across operating temperature range	-25	—	25	mV
Gain error ⁵	V _{GAIN}	T = 25 °C, Low-noise internal reference (REFSEL = 1V25LN or 2V5LN)	-2.5	—	2.5	%
		Across operating temperature range, Low-noise internal reference (REFSEL = 1V25LN or 2V5LN)	-3.5	—	3.5	%
External load capacitance, OUTSCALE=0	C _{LOAD}		—	—	75	pF

Parameter	Symbol	Test Condition	Min	Typ	Max	Unit
Note:						
<ol style="list-style-type: none"> 1. Supply current specifications are for VDAC circuitry operating with static output only and do not include current required to drive the load. 2. In differential mode, the output is defined as the difference between two single-ended outputs. Absolute voltage on each output is limited to the single-ended range. 3. Entire range is monotonic and has no missing codes. 4. Current from HUPERCLK is dependent on HUPERCLK frequency. This current contributes to the total supply current used when the clock to the DAC module is enabled in the CMU. 5. Gain is calculated by measuring the slope from 10% to 90% of full scale. Offset is calculated by comparing actual VDAC output at 10% of full scale to ideal VDAC output at 10% of full scale with the measured gain. 6. PSRR calculated as $20 * \log_{10}(\Delta V_{DD} / \Delta V_{OUT})$, VDAC output at 90% of full scale 						

4.1.17 Current Digital to Analog Converter (IDAC)

Table 4.25. Current Digital to Analog Converter (IDAC)

Parameter	Symbol	Test Condition	Min	Typ	Max	Unit
Number of ranges	N_{IDAC_RANGES}		—	4	—	ranges
Output current	I_{IDAC_OUT}	RANGSEL ¹ = RANGE0	0.05	—	1.6	μA
		RANGSEL ¹ = RANGE1	1.6	—	4.7	μA
		RANGSEL ¹ = RANGE2	0.5	—	16	μA
		RANGSEL ¹ = RANGE3	2	—	64	μA
Linear steps within each range	N_{IDAC_STEPS}		—	32	—	steps
Step size	SS_{IDAC}	RANGSEL ¹ = RANGE0	—	50	—	nA
		RANGSEL ¹ = RANGE1	—	100	—	nA
		RANGSEL ¹ = RANGE2	—	500	—	nA
		RANGSEL ¹ = RANGE3	—	2	—	μA
Total accuracy, STEPSEL ¹ = 0x10	ACC_{IDAC}	EM0 or EM1, AVDD=3.3 V, T = 25 °C	-3	—	3	%
		EM0 or EM1, Across operating temperature range	-18	—	22	%
		EM2 or EM3, Source mode, RANGSEL ¹ = RANGE0, AVDD=3.3 V, T = 25 °C	—	-2.7	—	%
		EM2 or EM3, Source mode, RANGSEL ¹ = RANGE1, AVDD=3.3 V, T = 25 °C	—	-2.5	—	%
		EM2 or EM3, Source mode, RANGSEL ¹ = RANGE2, AVDD=3.3 V, T = 25 °C	—	-1.5	—	%
		EM2 or EM3, Source mode, RANGSEL ¹ = RANGE3, AVDD=3.3 V, T = 25 °C	—	-1.0	—	%
		EM2 or EM3, Sink mode, RANGSEL ¹ = RANGE0, AVDD=3.3 V, T = 25 °C	—	-1.1	—	%
		EM2 or EM3, Sink mode, RANGSEL ¹ = RANGE1, AVDD=3.3 V, T = 25 °C	—	-1.1	—	%
		EM2 or EM3, Sink mode, RANGSEL ¹ = RANGE2, AVDD=3.3 V, T = 25 °C	—	-0.9	—	%
		EM2 or EM3, Sink mode, RANGSEL ¹ = RANGE3, AVDD=3.3 V, T = 25 °C	—	-0.9	—	%

Parameter	Symbol	Test Condition	Min	Typ	Max	Unit
Start up time	t_{IDAC_SU}	Output within 1% of steady state value	—	5	—	μs
Settling time, (output settled within 1% of steady state value),	t_{IDAC_SETTLE}	Range setting is changed	—	5	—	μs
		Step value is changed	—	1	—	μs
Current consumption ²	I_{IDAC}	EM0 or EM1 Source mode, excluding output current, Across operating temperature range	—	11	28	μA
		EM0 or EM1 Sink mode, excluding output current, Across operating temperature range	—	13	30	μA
		EM2 or EM3 Source mode, excluding output current, T = 25 °C	—	0.05	—	μA
		EM2 or EM3 Sink mode, excluding output current, T = 25 °C	—	0.07	—	μA
		EM2 or EM3 Source mode, excluding output current, T \geq 85 °C	—	11	—	μA
		EM2 or EM3 Sink mode, excluding output current, T \geq 85 °C	—	13	—	μA
Output voltage compliance in source mode, source current change relative to current sourced at 0 V	I_{COMP_SRC}	RANGESEL1=0, output voltage = $\min(V_{IOVDD}, V_{AVDD}^2-100 \text{ mV})$	—	0.11	—	%
		RANGESEL1=1, output voltage = $\min(V_{IOVDD}, V_{AVDD}^2-100 \text{ mV})$	—	0.06	—	%
		RANGESEL1=2, output voltage = $\min(V_{IOVDD}, V_{AVDD}^2-150 \text{ mV})$	—	0.04	—	%
		RANGESEL1=3, output voltage = $\min(V_{IOVDD}, V_{AVDD}^2-250 \text{ mV})$	—	0.03	—	%
Output voltage compliance in sink mode, sink current change relative to current sunk at IOVDD	I_{COMP_SINK}	RANGESEL1=0, output voltage = 100 mV	—	0.29	—	%
		RANGESEL1=1, output voltage = 100 mV	—	0.27	—	%
		RANGESEL1=2, output voltage = 150 mV	—	0.12	—	%
		RANGESEL1=3, output voltage = 250 mV	—	0.03	—	%

Note:

1. In IDAC_CURPROG register.
2. The IDAC is supplied by either AVDD, DVDD, or IOVDD based on the setting of ANASW in the EMU_PWRCTRL register and PWRSEL in the IDAC_CTRL register. Setting PWRSEL to 1 selects IOVDD. With PWRSEL cleared to 0, ANASW selects between AVDD (0) and DVDD (1).

4.1.18 Capacitive Sense (CSEN)

Table 4.26. Capacitive Sense (CSEN)

Parameter	Symbol	Test Condition	Min	Typ	Max	Unit
Single conversion time (1x accumulation)	t _{CNV}	12-bit SAR Conversions	—	20.2	—	μs
		16-bit SAR Conversions	—	26.4	—	μs
		Delta Modulation Conversion (single comparison)	—	1.55	—	μs
Maximum external capacitive load	C _{EXTMAX}	CS0CG=7 (Gain = 1x), including routing parasitics	—	68	—	pF
		CS0CG=0 (Gain = 10x), including routing parasitics	—	680	—	pF
Maximum external series impedance	R _{EXTMAX}		—	1	—	kΩ
Supply current, EM2 bonded conversions, WARMUP-MODE=NORMAL, WARMUPCNT=0	I _{CSEN_BOND}	12-bit SAR conversions, 20 ms conversion rate, CS0CG=7 (Gain = 1x), 10 channels bonded (total capacitance of 330 pF) ¹	—	326	—	nA
		Delta Modulation conversions, 20 ms conversion rate, CS0CG=7 (Gain = 1x), 10 channels bonded (total capacitance of 330 pF) ¹	—	226	—	nA
		12-bit SAR conversions, 200 ms conversion rate, CS0CG=7 (Gain = 1x), 10 channels bonded (total capacitance of 330 pF) ¹	—	33	—	nA
		Delta Modulation conversions, 200 ms conversion rate, CS0CG=7 (Gain = 1x), 10 channels bonded (total capacitance of 330 pF) ¹	—	25	—	nA
Supply current, EM2 scan conversions, WARMUP-MODE=NORMAL, WARMUPCNT=0	I _{CSEN_EM2}	12-bit SAR conversions, 20 ms scan rate, CS0CG=0 (Gain = 10x), 8 samples per scan ¹	—	690	—	nA
		Delta Modulation conversions, 20 ms scan rate, 8 comparisons per sample (DMCR = 1, DMR = 2), CS0CG=0 (Gain = 10x), 8 samples per scan ¹	—	515	—	nA
		12-bit SAR conversions, 200 ms scan rate, CS0CG=0 (Gain = 10x), 8 samples per scan ¹	—	79	—	nA
		Delta Modulation conversions, 200 ms scan rate, 8 comparisons per sample (DMCR = 1, DMR = 2), CS0CG=0 (Gain = 10x), 8 samples per scan ¹	—	57	—	nA

Parameter	Symbol	Test Condition	Min	Typ	Max	Unit
Supply current, continuous conversions, WARMUP-MODE=KEEPCSENWARM	I _{CSEN_ACTIVE}	SAR or Delta Modulation conversions of 33 pF capacitor, CS0CG=0 (Gain = 10x), always on	—	90.5	—	μA
HFPERCLK supply current	I _{CSEN_HFPERCLK}	Current contribution from HFPERCLK when clock to CSEN block is enabled.	—	2.25	—	μA/MHz

Note:

1. Current is specified with a total external capacitance of 33 pF per channel. Average current is dependent on how long the module is actively sampling channels within the scan period, and scales with the number of samples acquired. Supply current for a specific application can be estimated by multiplying the current per sample by the total number of samples per period ($\text{total_current} = \text{single_sample_current} * (\text{number_of_channels} * \text{accumulation})$).

4.1.19 Operational Amplifier (OPAMP)

Unless otherwise indicated, specified conditions are: Non-inverting input configuration, VDD = 3.3 V, DRIVESTRENGTH = 2, MAIN-OUTEN = 1, C_{LOAD} = 75 pF with OUTSCALE = 0, or C_{LOAD} = 37.5 pF with OUTSCALE = 1. Unit gain buffer and 3X-gain connection as specified in table footnotes⁸ 1.

Table 4.27. Operational Amplifier (OPAMP)

Parameter	Symbol	Test Condition	Min	Typ	Max	Unit
Supply voltage (from AVDD)	V _{OPA}	HCMDIS = 0, Rail-to-rail input range	2	—	3.8	V
		HCMDIS = 1	1.62	—	3.8	V
Input voltage	V _{IN}	HCMDIS = 0, Rail-to-rail input range	V _{VSS}	—	V _{OPA}	V
		HCMDIS = 1	V _{VSS}	—	V _{OPA} -1.2	V
Input impedance	R _{IN}		100	—	—	MΩ
Output voltage	V _{OUT}		V _{VSS}	—	V _{OPA}	V
Load capacitance ²	C _{LOAD}	OUTSCALE = 0	—	—	75	pF
		OUTSCALE = 1	—	—	37.5	pF
Output impedance	R _{OUT}	DRIVESTRENGTH = 2 or 3, 0.4 V ≤ V _{OUT} ≤ V _{OPA} - 0.4 V, -8 mA < I _{OUT} < 8 mA, Buffer connection, Full supply range	—	0.25	—	Ω
		DRIVESTRENGTH = 0 or 1, 0.4 V ≤ V _{OUT} ≤ V _{OPA} - 0.4 V, -400 μA < I _{OUT} < 400 μA, Buffer connection, Full supply range	—	0.6	—	Ω
		DRIVESTRENGTH = 2 or 3, 0.1 V ≤ V _{OUT} ≤ V _{OPA} - 0.1 V, -2 mA < I _{OUT} < 2 mA, Buffer connection, Full supply range	—	0.4	—	Ω
		DRIVESTRENGTH = 0 or 1, 0.1 V ≤ V _{OUT} ≤ V _{OPA} - 0.1 V, -100 μA < I _{OUT} < 100 μA, Buffer connection, Full supply range	—	1	—	Ω
Internal closed-loop gain	G _{CL}	Buffer connection	0.99	1	1.01	-
		3x Gain connection	2.93	2.99	3.05	-
		16x Gain connection	15.07	15.7	16.33	-
Active current ⁴	I _{OPA}	DRIVESTRENGTH = 3, OUTSCALE = 0	—	580	—	μA
		DRIVESTRENGTH = 2, OUTSCALE = 0	—	176	—	μA
		DRIVESTRENGTH = 1, OUTSCALE = 0	—	13	—	μA
		DRIVESTRENGTH = 0, OUTSCALE = 0	—	4.7	—	μA

Parameter	Symbol	Test Condition	Min	Typ	Max	Unit
Open-loop gain	G _{OL}	DRIVESTRENGTH = 3	—	135	—	dB
		DRIVESTRENGTH = 2	—	137	—	dB
		DRIVESTRENGTH = 1	—	121	—	dB
		DRIVESTRENGTH = 0	—	109	—	dB
Loop unit-gain frequency ⁷	UGF	DRIVESTRENGTH = 3, Buffer connection	—	3.38	—	MHz
		DRIVESTRENGTH = 2, Buffer connection	—	0.9	—	MHz
		DRIVESTRENGTH = 1, Buffer connection	—	132	—	kHz
		DRIVESTRENGTH = 0, Buffer connection	—	34	—	kHz
		DRIVESTRENGTH = 3, 3x Gain connection	—	2.57	—	MHz
		DRIVESTRENGTH = 2, 3x Gain connection	—	0.71	—	MHz
		DRIVESTRENGTH = 1, 3x Gain connection	—	113	—	kHz
		DRIVESTRENGTH = 0, 3x Gain connection	—	28	—	kHz
Phase margin	PM	DRIVESTRENGTH = 3, Buffer connection	—	67	—	°
		DRIVESTRENGTH = 2, Buffer connection	—	69	—	°
		DRIVESTRENGTH = 1, Buffer connection	—	63	—	°
		DRIVESTRENGTH = 0, Buffer connection	—	68	—	°
Output voltage noise	N _{OUT}	DRIVESTRENGTH = 3, Buffer connection, 10 Hz - 10 MHz	—	146	—	μVrms
		DRIVESTRENGTH = 2, Buffer connection, 10 Hz - 10 MHz	—	163	—	μVrms
		DRIVESTRENGTH = 1, Buffer connection, 10 Hz - 1 MHz	—	170	—	μVrms
		DRIVESTRENGTH = 0, Buffer connection, 10 Hz - 1 MHz	—	176	—	μVrms
		DRIVESTRENGTH = 3, 3x Gain connection, 10 Hz - 10 MHz	—	313	—	μVrms
		DRIVESTRENGTH = 2, 3x Gain connection, 10 Hz - 10 MHz	—	271	—	μVrms
		DRIVESTRENGTH = 1, 3x Gain connection, 10 Hz - 1 MHz	—	247	—	μVrms
		DRIVESTRENGTH = 0, 3x Gain connection, 10 Hz - 1 MHz	—	245	—	μVrms

Parameter	Symbol	Test Condition	Min	Typ	Max	Unit
Slew rate ⁵	SR	DRIVESTRENGTH = 3, INCBW=1 ³	—	4.7	—	V/ μ s
		DRIVESTRENGTH = 3, INCBW=0	—	1.5	—	V/ μ s
		DRIVESTRENGTH = 2, INCBW=1 ³	—	1.27	—	V/ μ s
		DRIVESTRENGTH = 2, INCBW=0	—	0.42	—	V/ μ s
		DRIVESTRENGTH = 1, INCBW=1 ³	—	0.17	—	V/ μ s
		DRIVESTRENGTH = 1, INCBW=0	—	0.058	—	V/ μ s
		DRIVESTRENGTH = 0, INCBW=1 ³	—	0.044	—	V/ μ s
		DRIVESTRENGTH = 0, INCBW=0	—	0.015	—	V/ μ s
Startup time ⁶	T _{START}	DRIVESTRENGTH = 2	—	—	12	μ s
Input offset voltage	V _{OSI}	DRIVESTRENGTH = 2 or 3, T = 25 °C	-3	—	3	mV
		DRIVESTRENGTH = 1 or 0, T = 25 °C	-3	—	3	mV
		DRIVESTRENGTH = 2 or 3, across operating temperature range	-12	—	12	mV
		DRIVESTRENGTH = 1 or 0, across operating temperature range	-30	—	30	mV
DC power supply rejection ratio ⁹	PSRR _{DC}	Input referred	—	70	—	dB
DC common-mode rejection ratio ⁹	CMRR _{DC}	Input referred	—	70	—	dB
Total harmonic distortion	THD _{OPA}	DRIVESTRENGTH = 2, 3x Gain connection, 1 kHz, V _{OUT} = 0.1 V to V _{OPA} - 0.1 V	—	90	—	dB
		DRIVESTRENGTH = 0, 3x Gain connection, 0.1 kHz, V _{OUT} = 0.1 V to V _{OPA} - 0.1 V	—	90	—	dB

Parameter	Symbol	Test Condition	Min	Typ	Max	Unit
Note:						
1. Specified configuration for 3X-Gain configuration is: INCBW = 1, HCMDIS = 1, RESINSEL = VSS, $V_{INPUT} = 0.5\text{ V}$, $V_{OUTPUT} = 1.5\text{ V}$. Nominal voltage gain is 3.						
2. If the maximum C_{LOAD} is exceeded, an isolation resistor is required for stability. See AN0038 for more information.						
3. When INCBW is set to 1 the OPAMP bandwidth is increased. This is allowed only when the non-inverting close-loop gain is ≥ 3 , or the OPAMP may not be stable.						
4. Current into the load resistor is excluded. When the OPAMP is connected with closed-loop gain > 1 , there will be extra current to drive the resistor feedback network. The internal resistor feedback network has total resistance of 143.5 kOhm, which will cause another $\sim 10\text{ }\mu\text{A}$ current when the OPAMP drives 1.5 V between output and ground.						
5. Step between 0.2V and $V_{OPA}-0.2\text{V}$, 10%-90% rising/falling range.						
6. From enable to output settled. In sample-and-off mode, RC network after OPAMP will contribute extra delay. Settling error $< 1\text{mV}$.						
7. In unit gain connection, UGF is the gain-bandwidth product of the OPAMP. In 3x Gain connection, UGF is the gain-bandwidth product of the OPAMP and 1/3 attenuation of the feedback network.						
8. Specified configuration for Unit gain buffer configuration is: INCBW = 0, HCMDIS = 0, RESINSEL = DISABLE. $V_{INPUT} = 0.5\text{ V}$, $V_{OUTPUT} = 0.5\text{ V}$.						
9. When HCMDIS=1 and input common mode transitions the region from $V_{OPA}-1.4\text{V}$ to $V_{OPA}-1\text{V}$, input offset will change. PSRR and CMRR specifications do not apply to this transition region.						

4.1.20 LCD Driver

Table 4.28. LCD Driver

Parameter	Symbol	Test Condition	Min	Typ	Max	Unit
Frame rate	f_{LCDFR}		30	—	100	Hz
LCD supply range ²	V_{LCDIN}		1.8	—	3.8	V
LCD output voltage range	V_{LCD}	Current source mode, No external LCD capacitor	2.0	—	$V_{LCDIN}-0.4$	V
		Step-down mode with external LCD capacitor	2.0	—	V_{LCDIN}	V
		Charge pump mode with external LCD capacitor	2.0	—	1.9 * V_{LCDIN}	V
Contrast control step size	$STEP_{CONTRAST}$	Current source mode	—	64	—	mV
		Charge pump or Step-down mode	—	43	—	mV
Contrast control step accuracy ¹	$ACC_{CONTRAST}$		—	+/-4	—	%
Note:						
1. Step size accuracy is measured relative to the typical step size, and typ value represents one standard deviation.						
2. V_{LCDIN} is selectable between the AVDD or DVDD supply pins, depending on EMU_PWRCTRL_ANASW.						

4.1.21 Pulse Counter (PCNT)

Table 4.29. Pulse Counter (PCNT)

Parameter	Symbol	Test Condition	Min	Typ	Max	Unit
Input frequency	F _{IN}	Asynchronous Single and Quadrature Modes	—	—	20	MHz
		Sampled Modes with Debounce filter set to 0.	—	—	8	kHz

4.1.22 Analog Port (APORT)

Table 4.30. Analog Port (APORT)

Parameter	Symbol	Test Condition	Min	Typ	Max	Unit
Supply current ^{2 1}	I _{APORT}	Operation in EM0/EM1	—	7	—	μA
		Operation in EM2/EM3	—	63	—	nA

Note:

1. Specified current is for continuous APORT operation. In applications where the APORT is not requested continuously (e.g. periodic ACMP requests from LESENSE in EM2), the average current requirements can be estimated by multiplying the duty cycle of the requests by the specified continuous current number.
2. Supply current increase that occurs when an analog peripheral requests access to APORT. This current is not included in reported module currents. Additional peripherals requesting access to APORT do not incur further current.

4.1.23 I2C

4.1.23.1 I2C Standard-mode (Sm)¹Table 4.31. I2C Standard-mode (Sm)¹

Parameter	Symbol	Test Condition	Min	Typ	Max	Unit
SCL clock frequency ²	f _{SCL}		0	—	100	kHz
SCL clock low time	t _{LOW}		4.7	—	—	μs
SCL clock high time	t _{HIGH}		4	—	—	μs
SDA set-up time	t _{SU_DAT}		250	—	—	ns
SDA hold time ³	t _{HD_DAT}		100	—	3450	ns
Repeated START condition set-up time	t _{SU_STA}		4.7	—	—	μs
(Repeated) START condition hold time	t _{HD_STA}		4	—	—	μs
STOP condition set-up time	t _{SU_STO}		4	—	—	μs
Bus free time between a STOP and START condition	t _{BUF}		4.7	—	—	μs

Note:

1. For CLHR set to 0 in the I2Cn_CTRL register.
2. For the minimum HPPERCLK frequency required in Standard-mode, refer to the I2C chapter in the reference manual.
3. The maximum SDA hold time (t_{HD_DAT}) needs to be met only when the device does not stretch the low time of SCL (t_{LOW}).

4.1.23.2 I2C Fast-mode (Fm)¹Table 4.32. I2C Fast-mode (Fm)¹

Parameter	Symbol	Test Condition	Min	Typ	Max	Unit
SCL clock frequency ²	f_{SCL}		0	—	400	kHz
SCL clock low time	t_{LOW}		1.3	—	—	μ s
SCL clock high time	t_{HIGH}		0.6	—	—	μ s
SDA set-up time	t_{SU_DAT}		100	—	—	ns
SDA hold time ³	t_{HD_DAT}		100	—	900	ns
Repeated START condition set-up time	t_{SU_STA}		0.6	—	—	μ s
(Repeated) START condition hold time	t_{HD_STA}		0.6	—	—	μ s
STOP condition set-up time	t_{SU_STO}		0.6	—	—	μ s
Bus free time between a STOP and START condition	t_{BUF}		1.3	—	—	μ s

Note:

1. For CLHR set to 1 in the I2Cn_CTRL register.
2. For the minimum HPPERCLK frequency required in Fast-mode, refer to the I2C chapter in the reference manual.
3. The maximum SDA hold time ($t_{HD,DAT}$) needs to be met only when the device does not stretch the low time of SCL (t_{LOW}).

4.1.23.3 I2C Fast-mode Plus (Fm+)¹

Table 4.33. I2C Fast-mode Plus (Fm+)¹

Parameter	Symbol	Test Condition	Min	Typ	Max	Unit
SCL clock frequency ²	f _{SCL}		0	—	1000	kHz
SCL clock low time	t _{LOW}		0.5	—	—	μs
SCL clock high time	t _{HIGH}		0.26	—	—	μs
SDA set-up time	t _{SU_DAT}		50	—	—	ns
SDA hold time	t _{HD_DAT}		100	—	—	ns
Repeated START condition set-up time	t _{SU_STA}		0.26	—	—	μs
(Repeated) START condition hold time	t _{HD_STA}		0.26	—	—	μs
STOP condition set-up time	t _{SU_STO}		0.26	—	—	μs
Bus free time between a STOP and START condition	t _{BUF}		0.5	—	—	μs

Note:

1. For CLHR set to 0 or 1 in the I2Cn_CTRL register.
2. For the minimum HPPERCLK frequency required in Fast-mode Plus, refer to the I2C chapter in the reference manual.

4.1.24 USART SPI

SPI Master Timing

Table 4.34. SPI Master Timing

Parameter	Symbol	Test Condition	Min	Typ	Max	Unit
SCLK period ^{1 3 2}	t _{SCLK}	All USARTs except USART2	2 * t _{HFPERCLK}	—	—	ns
		USART2	2 * t _{HFPERBCLK}	—	—	ns
CS to MOSI ^{1 3}	t _{CS_MO}	USART2, location 4, IOVDD = 1.8 V	-3.2	—	6.8	ns
		USART2, location 4, IOVDD = 3.0 V	-2.3	—	6.0	ns
		USART2, location 5, IOVDD = 1.8 V	-8.1	—	6.3	ns
		USART2, location 5, IOVDD = 3.0 V	-7.3	—	4.4	ns
		All other USARTs and locations, IOVDD = 1.8 V	-15	—	13	ns
		All other USARTs and locations, IOVDD = 3.0 V	-13	—	11	ns
SCLK to MOSI ^{1 3}	t _{SCLK_MO}	USART2, location 4, IOVDD = 1.8 V	-0.3	—	9.2	ns
		USART2, location 4, IOVDD = 3.0 V	-0.3	—	8.6	ns
		USART2, location 5, IOVDD = 1.8 V	-3.6	—	5.0	ns
		USART2, location 5, IOVDD = 3.0 V	-3.4	—	3.2	ns
		All other USARTs and locations, IOVDD = 1.8 V	-10	—	11	ns
		All other USARTs and locations, IOVDD = 3.0 V	-9	—	11	ns
MISO setup time ^{1 3}	t _{SU_MI}	USART2, location 4, IOVDD = 1.8 V	39.7	—	—	ns
		USART2, location 4, IOVDD = 3.0 V	22.4	—	—	ns
		USART2, location 5, IOVDD = 1.8 V	49.2	—	—	ns
		USART2, location 5, IOVDD = 3.0 V	30.0	—	—	ns
		All other USARTs and locations, IOVDD = 1.8 V	55	—	—	ns
		All other USARTs and locations, IOVDD = 3.0 V	36	—	—	ns

Parameter	Symbol	Test Condition	Min	Typ	Max	Unit
MISO hold time ^{1 3}	t_{H_MI}	USART2, location 4, IOVDD = 1.8 V	-11.6	—	—	ns
		USART2, location 4, IOVDD = 3.0 V	-11.6	—	—	ns
		USART2, location 5, IOVDD = 1.8 V	-9.1	—	—	ns
		USART2, location 5, IOVDD = 3.0 V	-9.1	—	—	ns
		All other USARTs and locations, IOVDD = 1.8 V	-8	—	—	ns
		All other USARTs and locations, IOVDD = 3.0 V	-8	—	—	ns

Note:

1. Applies for both CLKPHA = 0 and CLKPHA = 1 (figure only shows CLKPHA = 0).
2. t_{H_PERCLK} is one period of the selected HPERCLK.
3. Measurement done with 8 pF output loading at 10% and 90% of V_{DD} (figure shows 50% of V_{DD}).



Figure 4.1. SPI Master Timing Diagram

SPI Slave Timing

Table 4.35. SPI Slave Timing

Parameter	Symbol	Test Condition	Min	Typ	Max	Unit
SCLK period ^{1 3 2}	t_{SCLK}		6 * $t_{HFPERCLK}$	—	—	ns
SCLK high time ^{1 3 2}	t_{SCLK_HI}		2.5 * $t_{HFPERCLK}$	—	—	ns
SCLK low time ^{1 3 2}	t_{SCLK_LO}		2.5 * $t_{HFPERCLK}$	—	—	ns
CS active to MISO ^{1 3}	$t_{CS_ACT_MI}$		24	—	69	ns
CS disable to MISO ^{1 3}	$t_{CS_DIS_MI}$		19	—	175	ns
MOSI setup time ^{1 3}	t_{SU_MO}		7	—	—	ns
MOSI hold time ^{1 3 2}	t_{H_MO}		6	—	—	ns
SCLK to MISO ^{1 3 2}	t_{SCLK_MI}		16 + 1.5 * $t_{HFPERCLK}$	—	43 + 2.5 * $t_{HFPERCLK}$	ns

Note:

1. Applies for both CLKPHA = 0 and CLKPHA = 1 (figure only shows CLKPHA = 0).
2. $t_{HFPERCLK}$ is one period of the selected HFPERCLK.
3. Measurement done with 8 pF output loading at 10% and 90% of V_{DD} (figure shows 50% of V_{DD}).



Figure 4.2. SPI Slave Timing Diagram

4.1.25 External Bus Interface (EBI)

EBI Write Enable Output Timing

Timing applies to both EBI_WEn and EBI_NANDWEn for all addressing modes and both polarities. All numbers are based on route locations 0,1,2 only (with all EBI alternate functions using the same location at the same time). Timing is specified at 10% and 90% of IOVDD, 25 pF external loading, and slew rate for all GPIO set to 6.

Table 4.36. EBI Write Enable Timing

Parameter	Symbol	Test Condition	Min	Typ	Max	Unit
Output hold time, from trailing EBI_WEn / EBI_NANDWEn edge to EBI_AD, EBI_A, EBI_CS _n , EBI_BL _n invalid	t _{OH_WEn}	IOVDD ≥ 1.62 V	-22 + (WRHOLD * t _{HFCOR-ECLK})	—	—	ns
		IOVDD ≥ 3.0 V	-13 + (WRHOLD * t _{HFCOR-ECLK})	—	—	ns
Output setup time, from EBI_AD, EBI_A, EBI_CS _n , EBI_BL _n valid to leading EBI_WEn / EBI_NANDWEn edge ¹	t _{OSU_WEn}	IOVDD ≥ 1.62 V	-12 + (WRSET-UP * t _{HFCOR-ECLK})	—	—	ns
		IOVDD ≥ 3.0 V	-10 + (WRSET-UP * t _{HFCOR-ECLK})	—	—	ns
EBI_WEn / EBI_NANDWEn pulse width ¹	t _{WIDTH_WEn}	IOVDD ≥ 1.62 V	-6 + (MAX(1, WRSTRB) * t _{HFCOR-ECLK})	—	—	ns
		IOVDD ≥ 3.0 V	-5 + (MAX(1, WRSTRB) * t _{HFCOR-ECLK})	—	—	ns

Note:

- The figure shows the timing for the case that the half strobe length functionality is not used, i.e. HALFWE=0. The leading edge of EBI_WEn can be moved to the right by setting HALFWE=1. This decreases the length of t_{WIDTH_WEn} and increases the length of t_{OSU_WEn} by 1/2 * t_{HCLKNODIV}.



Figure 4.3. EBI Write Enable Output Timing Diagram

EBI Address Latch Enable Output Timing

Timing applies to multiplexed addressing modes D8A24ALE and D16A16ALE for both polarities. All numbers are based on route locations 0,1,2 only (with all EBI alternate functions using the same location at the same time). Timing is specified at 10% and 90% of IOVDD, 25 pF external loading, and slew rate for all GPIO set to 6.

Table 4.37. EBI Address Latch Enable Output Timing

Parameter	Symbol	Test Condition	Min	Typ	Max	Unit
Output hold time, from trailing EBI_ALE edge to EBI_AD invalid ^{1 2}	t _{OH_ALEn}	IOVDD ≥ 1.62 V	-22 + (ADDR-HOLD * t _{HFCOR-ECLK})	—	—	ns
		IOVDD ≥ 3.0 V	-11 + (ADDR-HOLD * t _{HFCOR-ECLK})	—	—	ns
Output setup time, from EBI_AD valid to leading EBI_ALE edge	t _{OSU_ALEn}	IOVDD ≥ 1.62 V	-12	—	—	ns
		IOVDD ≥ 3.0 V	-9	—	—	ns
EBI_ALEn pulse width ¹	t _{WIDTH_ALEn}	IOVDD ≥ 1.62 V	-4 + ((ADDR-SETUP + 1) * t _{HFCOR-ECLK})	—	—	ns
		IOVDD ≥ 3.0 V	-3 + ((ADDR-SETUP + 1) * t _{HFCOR-ECLK})	—	—	ns

Note:

1. The figure shows the timing for the case that the half strobe length functionality is not used, i.e. HALFALE=0. The trailing edge of EBI_ALEn can be moved to the left by setting HALFALE=1. This decreases the length of t_{WIDTH_ALEn} and increases the length of t_{OSU_ALEn} by t_{HFCORECLK} - 1/2 * t_{HFCLKNODIV}.
2. The figure shows a write operation. For a multiplexed read operation the address hold time is controlled via the RDSETUP state instead of via the ADDRHOLD state.



Figure 4.4. EBI Address Latch Enable Output Timing Diagram

EBI Read Enable Output Timing

Timing applies to both EBI_REn and EBI_NANDREn for all addressing modes and both polarities. Output timing for EBI_AD applies only to multiplexed addressing modes D8A24ALE and D16A16ALE. All numbers are based on route locations 0,1,2 only (with all EBI alternate functions using the same location at the same time). Timing is specified at 10% and 90% of IOVDD, 25 pF external loading, and slew rate for all GPIO set to 6.

Table 4.38. EBI Read Enable Output Timing

Parameter	Symbol	Test Condition	Min	Typ	Max	Unit
Output hold time, from trailing EBI_REn / EBI_NANDREn edge to EBI_AD, EBI_A, EBI_CS _n , EBI_BLn invalid	t _{OH_REn}	IOVDD ≥ 1.62 V	-23 + (RDHOLD * t _{HFCOR-ECLK})	—	—	ns
		IOVDD ≥ 3.0 V	-13 + (RDHOLD * t _{HFCOR-ECLK})	—	—	ns
Output setup time, from EBI_AD, EBI_A, EBI_CS _n , EBI_BLn valid to leading EBI_REn / EBI_NANDREn edge ¹	t _{OSU_REn}	IOVDD ≥ 1.62 V	-12 + (RDSETUP * t _{HFCOR-ECLK})	—	—	ns
		IOVDD ≥ 3.0 V	-11 + (RDSETUP * t _{HFCOR-ECLK})	—	—	ns
EBI_REn pulse width ^{1 2}	t _{WIDTH_REn}	IOVDD ≥ 1.62 V	-6 + (MAX(1, RDSTRB) * t _{HFCOR-ECLK})	—	—	ns
		IOVDD ≥ 3.0 V	-4 + (MAX(1, RDSTRB) * t _{HFCOR-ECLK})	—	—	ns

Note:

- The figure shows the timing for the case that the half strobe length functionality is not used, i.e. HALFRE=0. The leading edge of EBI_REn can be moved to the right by setting HALFRE=1. This decreases the length of t_{WIDTH_REn} and increases the length of t_{OSU_REn} by 1/2 * t_{HFCOR-ECLK}.
- When page mode is used, RDSTRB is replaced by RDPA for page hits.



Figure 4.5. EBI Read Enable Output Timing Diagram

EBI TFT Output Timing

All numbers are based on route locations 0,1,2 only (with all EBI alternate functions using the same location at the same time). Timing is specified at 10% and 90% of IOVDD, 25 pF external loading, and slew rate for all GPIO set to 6.

Table 4.39. EBI TFT Output Timing

Parameter	Symbol	Test Condition	Min	Typ	Max	Unit
Output hold time, EBI_DCLK to EBI_AD invalid	t _{OH_DCLK}	IOVDD ≥ 1.62 V	-23 + (TFTHOLD * t _{HFCOR-ECLK})	—	—	ns
		IOVDD ≥ 3.0 V	-12 + (TFTHOLD * t _{HFCOR-ECLK})	—	—	ns
Output setup time, EBI_AD valid to EBI_DCLK	t _{OSU_DCLK}	IOVDD ≥ 1.62 V	-11 + (TFTSET-UP * t _{HFCOR-ECLK})	—	—	ns
		IOVDD ≥ 3.0 V	-9 + (TFTSET-UP * t _{HFCOR-ECLK})	—	—	ns



Figure 4.6. EBI TFT Output Timing

EBI Read Enable Timing Requirements

Timing applies to both EBI_REn and EBI_NANDREn for all addressing modes and both polarities. All numbers are based on route locations 0,1,2 only (with all EBI alternate functions using the same location at the same time). Timing is specified at 10% and 90% of IOVDD, 25 pF external loading, and slew rate for all GPIO set to 6.

Table 4.40. EBI Read Enable Timing Requirements

Parameter	Symbol	Test Condition	Min	Typ	Max	Unit
Setup time, from EBI_AD valid to trailing EBI_REn edge	t_{SU_REn}	IOVDD \geq 1.62 V	55	—	—	ns
		IOVDD \geq 3.0 V	36	—	—	ns
Hold time, from trailing EBI_REn edge to EBI_AD invalid	t_{H_REn}	IOVDD \geq 1.62 V	-9	—	—	ns



Figure 4.7. EBI Read Enable Timing Requirements

EBI Ready/Wait Timing Requirements

Timing applies to both EBI_REn and EBI_WEn for all addressing modes and both polarities. All numbers are based on route locations 0,1,2 only (with all EBI alternate functions using the same location at the same time). Timing is specified at 10% and 90% of IOVDD, 25 pF external loading, and slew rate for all GPIO set to 6.

Table 4.41. EBI Ready/Wait Timing Requirements

Parameter	Symbol	Test Condition	Min	Typ	Max	Unit
Setup time, from EBI_ARDY valid to trailing EBI_REn, EBI_WEn edge	t_{SU_ARDY}	IOVDD \geq 1.62 V	$55 + (3 * t_{HFCOR-ECLK})$	—	—	ns
		IOVDD \geq 3.0 V	$36 + (3 * t_{HFCOR-ECLK})$	—	—	ns
Hold time, from trailing EBI_REn, EBI_WEn edge to EBI_ARDY invalid	t_{H_ARDY}	IOVDD \geq 1.62 V	-9	—	—	ns

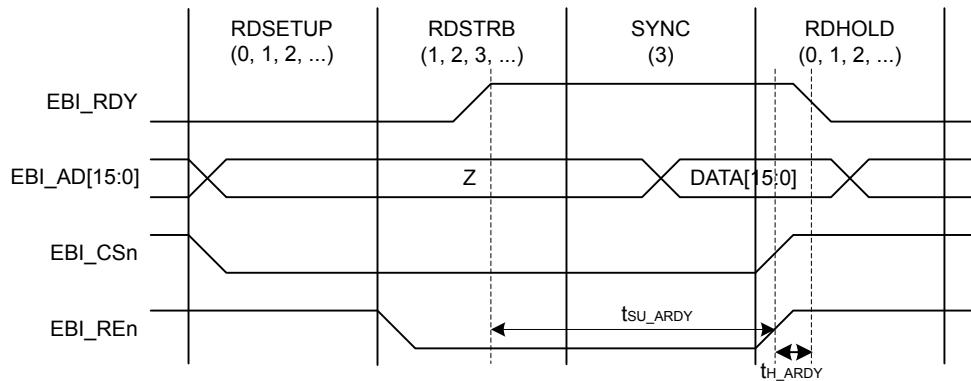

Figure 4.8. EBI Ready/Wait Timing Requirements

4.1.26 Ethernet (ETH)

MII Transmit Timing

Timing is specified with $3.0\text{ V} \leq \text{IOVDD} \leq 3.8\text{ V}$, 25 pF external loading, and slew rate for all GPIO set to 6 unless otherwise indicated.

Table 4.42. Ethernet MII Transmit Timing

Parameter	Symbol	Test Condition	Min	Typ	Max	Unit
TX_CLK frequency	$F_{\text{TX_CLK}}$	Output slew rate set to 7	—	25	—	MHz
TX_CLK duty cycle	$\text{DC}_{\text{TX_CLK}}$		35	—	65	%
Output delay, TX_CLK to TXD[3:0], TX_EN, TX_ER	t_{OUT}		0	—	25	ns



Figure 4.9. Ethernet MII Transmit Timing

MII Receive Timing

Timing is specified with $3.0\text{ V} \leq \text{IOVDD} \leq 3.8\text{ V}$, 25 pF external loading, and slew rate for all GPIO set to 6 unless otherwise indicated.

Table 4.43. Ethernet MII Receive Timing

Parameter	Symbol	Test Condition	Min	Typ	Max	Unit
RX_CLK frequency	$F_{\text{RX_CLK}}$		—	25	—	MHz
RX_CLK duty cycle	$DC_{\text{RX_CLK}}$		35	—	65	%
Setup time, RXD[3:0], RX_DV, RX_ER valid to RX_CLK	t_{SU}		6	—	—	ns
Hold time, RX_CLK to RXD[3:0], RX_DV, RX_ER change	t_{HD}		5	—	—	ns



Figure 4.10. Ethernet MII Receive Timing

RMII Transmit Timing

Timing is specified with $3.0\text{ V} \leq \text{IOVDD} \leq 3.8\text{ V}$, 25 pF external loading, and slew rate for all GPIO set to 6 unless otherwise indicated.

Table 4.44. Ethernet RMII Transmit Timing

Parameter	Symbol	Test Condition	Min	Typ	Max	Unit
REF_CLK frequency	$F_{\text{REF_CLK}}$	Output slew rate set to 7	—	50	—	MHz
REF_CLK duty cycle	$DC_{\text{REF_CLK}}$		35	—	65	%
Output delay, REF_CLK to TXD[1:0], TX_EN	t_{OUT}		2.3	—	14.1	ns

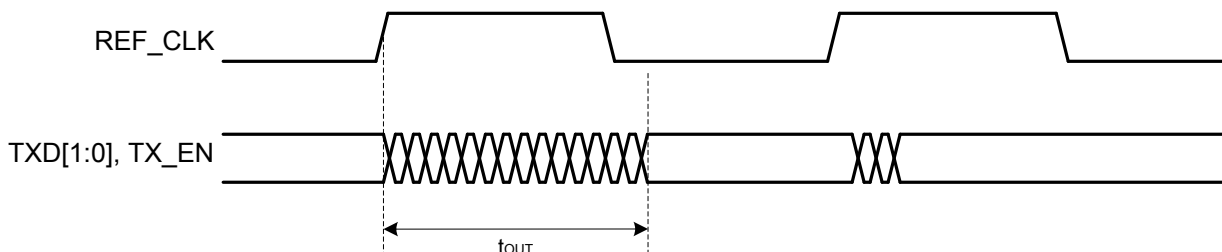

Figure 4.11. Ethernet RMII Transmit Timing

RMII Receive Timing

Timing is specified with $3.0\text{ V} \leq \text{IOVDD} \leq 3.8\text{ V}$, 25 pF external loading, and slew rate for all GPIO set to 6 unless otherwise indicated.

Table 4.45. Ethernet RMII Receive Timing

Parameter	Symbol	Test Condition	Min	Typ	Max	Unit
REF_CLK frequency	$F_{\text{REF_CLK}}$	Output slew rate set to 7	—	50	—	MHz
REF_CLK duty cycle	$DC_{\text{REF_CLK}}$		35	—	65	%
Setup time, RXD[1:0], CRS_DV, RX_ER valid to REF_CLK	t_{SU}		4	—	—	ns
Hold time, REF_CLK to RXD[1:0], CRS_DV, RX_ER change	t_{HD}		2	—	—	ns

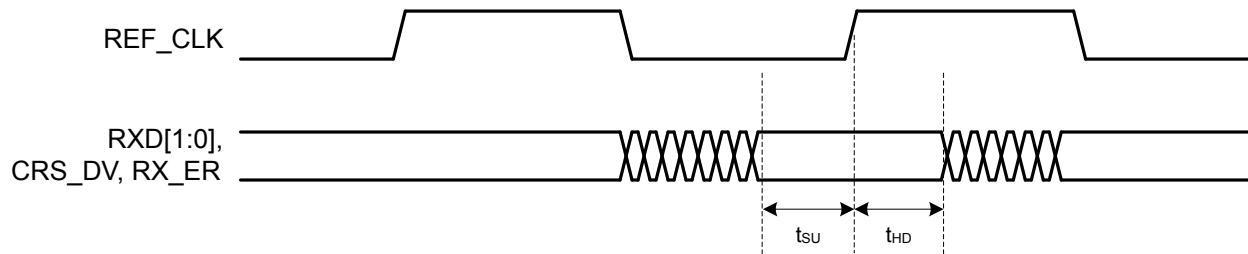

Figure 4.12. Ethernet RMII Receive Timing

4.1.27 Serial Data I/O Host Controller (SDIO)

SDIO DS Mode Timing

Timing is specified at 3.0 V IOVDD with voltage scaling disabled. Slew rate for SD_CLK set to 6, all other GPIO set to 6, DRIVES-TRENGTH = STRONG for all pins. SDIO_CTRL_TXDLYMUXSEL = 1. Loading between 5 and 10 pF on all pins or between 10 and 40 pF on all pins.

Table 4.46. SDIO DS Mode Timing (Location 0)

Parameter	Symbol	Test Condition	Min	Typ	Max	Unit
Clock frequency during data transfer	F _{SD_CLK}	Using HFRCO, AUXHFRCO, or USHFRCO	—	—	23	MHz
		Using HFXO	—	—	20.5	MHz
Clock low time	t _{WL}	Using HFRCO, AUXHFRCO, or USHFRCO	19.6	—	—	ns
		Using HFXO	19.1	—	—	ns
Clock high time	t _{WH}	Using HFRCO, AUXHFRCO, or USHFRCO	19.6	—	—	ns
		Using HFXO	19.1	—	—	ns
Clock rise time	t _R		1.4	—	4.9	ns
Clock fall time	t _F		1.2	—	4.0	ns
Input setup time, CMD, DAT[0:3] valid to SD_CLK	t _{ISU}		7	—	—	ns
Input hold time, SD_CLK to CMD, DAT[0:3] change	t _{IH}		0	—	—	ns
Output delay time, SD_CLK to CMD, DAT[0:3] valid	t _{ODLY}		—	—	18.6	ns
Output hold time, SD_CLK to CMD, DAT[0:3] change	t _{OH}		5	—	—	ns

Table 4.47. SDIO DS Mode Timing (Location 1)

Parameter	Symbol	Test Condition	Min	Typ	Max	Unit
Clock frequency during data transfer	F _{SD_CLK}	Using HFRCO, AUXHFRCO, or USHFRCO	—	—	14	MHz
		Using HFXO	—	—	13.5	MHz
Clock low time	t _{WL}	Using HFRCO, AUXHFRCO, or USHFRCO	32.3	—	—	ns
		Using HFXO	29.2	—	—	ns
Clock high time	t _{WH}	Using HFRCO, AUXHFRCO, or USHFRCO	32.3	—	—	ns
		Using HFXO	29.2	—	—	ns
Clock rise time	t _R		1.4	—	4.9	ns
Clock fall time	t _F		1.2	—	4.0	ns

Parameter	Symbol	Test Condition	Min	Typ	Max	Unit
Input setup time, CMD, DAT[0:3] valid to SD_CLK	t_{ISU}		11.6	—	—	ns
Input hold time, SD_CLK to CMD, DAT[0:3] change	t_{IH}		0	—	—	ns
Output delay time, SD_CLK to CMD, DAT[0:3] valid	t_{ODLY}		—	—	29.5	ns
Output hold time, SD_CLK to CMD, DAT[0:3] change	t_{OH}		5	—	—	ns



Input Timing

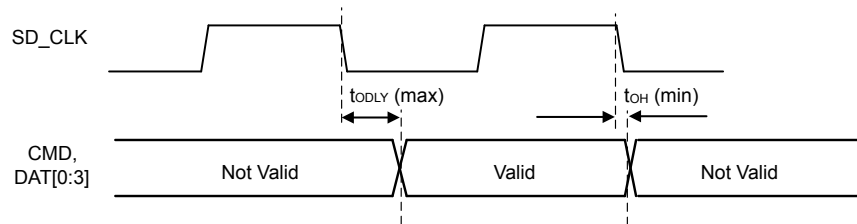

Output Timing

Figure 4.13. SDIO DS Mode Timing

SDIO HS Mode Timing

Timing is specified at 3.0 V IOVDD with voltage scaling disabled. Slew rate for SD_CLK set to 7, all other GPIO set to 6, DRIVES-TRENGTH = STRONG for all pins. SDIO_CTRL_TXDLYMUXSEL = 1. Loading between 5 and 10 pF on all pins or between 10 and 30 pF on all pins.

Table 4.48. SDIO HS Mode Timing (Location 0)

Parameter	Symbol	Test Condition	Min	Typ	Max	Unit
Clock frequency during data transfer	F _{SD_CLK}	Using HFRCO, AUXHFRCO, or USHFRCO	—	—	46	MHz
		Using HFXO	—	—	46	MHz
Clock low time	t _{WL}	Using HFRCO, AUXHFRCO, or USHFRCO	9.8	—	—	ns
		Using HFXO	8.2	—	—	ns
Clock high time	t _{WH}	Using HFRCO, AUXHFRCO, or USHFRCO	9.8	—	—	ns
		Using HFXO	8.2	—	—	ns
Clock rise time	t _R		0.8	—	3.0	ns
Input setup time, CMD, DAT[0:3] valid to SD_CLK	t _{ISU}		3.4	—	—	ns
Input hold time, SD_CLK to CMD, DAT[0:3] change	t _{IH}		2.5	—	—	ns
Output delay time, SD_CLK to CMD, DAT[0:3] valid	t _{ODLY}		—	—	14.4	ns
Output hold time, SD_CLK to CMD, DAT[0:3] change	t _{OH}		2	—	—	ns

Table 4.49. SDIO HS Mode Timing (Location 1)

Parameter	Symbol	Test Condition	Min	Typ	Max	Unit
Clock frequency during data transfer	F _{SD_CLK}	Using HFRCO, AUXHFRCO, or USHFRCO	—	—	30	MHz
		Using HFXO	—	—	30	MHz
Clock low time	t _{WL}	Using HFRCO, AUXHFRCO, or USHFRCO	15	—	—	ns
		Using HFXO	12.9	—	—	ns
Clock high time	t _{WH}	Using HFRCO, AUXHFRCO, or USHFRCO	15	—	—	ns
		Using HFXO	12.9	—	—	ns
Clock rise time	t _R		0.8	—	3.0	ns
Input setup time, CMD, DAT[0:3] valid to SD_CLK	t _{ISU}		3.3	—	—	ns
Input hold time, SD_CLK to CMD, DAT[0:3] change	t _{IH}		2.5	—	—	ns

Parameter	Symbol	Test Condition	Min	Typ	Max	Unit
Output delay time, SD_CLK to CMD, DAT[0:3] valid	t_{ODLY}		—	—	22.9	ns
Output hold time, SD_CLK to CMD, DAT[0:3] change	t_{OH}		2	—	—	ns



Input Timing



Output Timing

Figure 4.14. SDIO HS Mode Timing

SDIO SDR Mode Timing

Timing is specified at 1.62 V IOVDD with voltage scaling disabled. Slew rate for SD_CLK set to 7, all other GPIO set to 6, DRIVES-TRENGTH = STRONG for all pins. SDIO_CTRL_TXDLYMUXSEL = 0. Loading between 5 and 10 pF on all pins or between 10 and 40 pF on all pins.

Table 4.50. SDIO SDR Mode Timing (Location 0)

Parameter	Symbol	Test Condition	Min	Typ	Max	Unit
Clock frequency during data transfer	F _{SD_CLK}	Using HFRCO, AUXHFRCO, or USHFRCO	—	—	26	MHz
		Using HFXO	—	—	26	MHz
Clock low time	t _{WL}	Using HFRCO, AUXHFRCO, or USHFRCO	17.3	—	—	ns
		Using HFXO	14.9	—	—	ns
Clock high time	t _{WH}	Using HFRCO, AUXHFRCO, or USHFRCO	17.3	—	—	ns
		Using HFXO	14.9	—	—	ns
Clock rise time	t _R		0.8	—	7.6	ns
Input setup time, CMD, DAT[0:3] valid to SD_CLK	t _{ISU}		5.1	—	—	ns
Input hold time, SD_CLK to CMD, DAT[0:3] change	t _{IH}		1.5	—	—	ns
Output delay time, SD_CLK to CMD, DAT[0:3] valid	t _{ODLY}		—	—	19.5	ns
Output hold time, SD_CLK to CMD, DAT[0:3] change	t _{OH}		0.8	—	—	ns

Table 4.51. SDIO SDR Mode Timing (Location 1)

Parameter	Symbol	Test Condition	Min	Typ	Max	Unit
Clock frequency during data transfer	F _{SD_CLK}	Using HFRCO, AUXHFRCO, or USHFRCO	—	—	23	MHz
		Using HFXO	—	—	23	MHz
Clock low time	t _{WL}	Using HFRCO, AUXHFRCO, or USHFRCO	19.6	—	—	ns
		Using HFXO	16.9	—	—	ns
Clock high time	t _{WH}	Using HFRCO, AUXHFRCO, or USHFRCO	19.6	—	—	ns
		Using HFXO	16.9	—	—	ns
Clock rise time	t _R		0.8	—	7.6	ns
Input setup time, CMD, DAT[0:3] valid to SD_CLK	t _{ISU}		5.0	—	—	ns
Input hold time, SD_CLK to CMD, DAT[0:3] change	t _{IH}		1.5	—	—	ns

Parameter	Symbol	Test Condition	Min	Typ	Max	Unit
Output delay time, SD_CLK to CMD, DAT[0:3] valid	t_{ODLY}		—	—	27.0	ns
Output hold time, SD_CLK to CMD, DAT[0:3] change	t_{OH}		0.8	—	—	ns



Input Timing



Output Timing

Figure 4.15. SDIO SDR Mode Timing

SDIO DDR Mode Timing

Timing is specified at 1.62 V IOVDD with voltage scaling disabled. Slew rate for SD_CLK set to 6, all other GPIO set to 6, DRIVES-TRENGTH = STRONG for all pins. SDIO_CTRL_TXDLYMUXSEL = 1. Loading between 5 and 10 pF on all pins or between 10 and 30 pF on all pins.

Table 4.52. SDIO DDR Mode Timing (Location 0)

Parameter	Symbol	Test Condition	Min	Typ	Max	Unit
Clock frequency during data transfer	F _{SD_CLK}	Using HFRCO, AUXHFRCO, or USHFRCO	—	—	20	MHz
		Using HFXO	—	—	17.5	MHz
Clock low time	t _{WL}	Using HFRCO, AUXHFRCO, or USHFRCO	22.6	—	—	ns
		Using HFXO	22.4	—	—	ns
Clock high time	t _{WH}	Using HFRCO, AUXHFRCO, or USHFRCO	22.6	—	—	ns
		Using HFXO	22.4	—	—	ns
Clock rise time	t _R		1.4	—	8.7	ns
Clock fall time	t _F		1.2	—	6.4	ns
Input setup time, CMD valid to SD_CLK	t _{ISU}		7.4	—	—	ns
Input hold time, SD_CLK to CMD change	t _{IH}		1.5	—	—	ns
Output delay time, SD_CLK to CMD valid	t _{ODLY}		—	—	22.0	ns
Output hold time, SD_CLK to CMD change	t _{OH}		2.0	—	—	ns
Input setup time, DAT[0:3] valid to SD_CLK	t _{ISU2X}		9.5	—	—	ns
Input hold time, SD_CLK to DAT[0:3] change	t _{IH2X}		1.5	—	—	ns
Output delay time, SD_CLK to DAT[0:3] valid	t _{ODLY2X}		—	—	24.4	ns
Output hold time, SD_CLK to DAT[0:3] change	t _{OH2X}		2.0	—	—	ns

Table 4.53. SDIO DDR Mode Timing (Location 1)

Parameter	Symbol	Test Condition	Min	Typ	Max	Unit
Clock frequency during data transfer	F _{SD_CLK}	Using HFRCO, AUXHFRCO, or USHFRCO	—	—	12.5	MHz
		Using HFXO	—	—	12.5	MHz
Clock low time	t _{WL}	Using HFRCO, AUXHFRCO, or USHFRCO	36.1	—	—	ns
		Using HFXO	31.6	—	—	ns

Parameter	Symbol	Test Condition	Min	Typ	Max	Unit
Clock high time	t_{WH}	Using HFRCO, AUXHFRCO, or USHFRCO	36.1	—	—	ns
		Using HFXO	31.6	—	—	ns
Clock rise time	t_R		1.4	—	8.7	ns
Clock fall time	t_F		1.2	—	6.4	ns
Input setup time, CMD valid to SD_CLK	t_{ISU}		11.9	—	—	ns
Input hold time, SD_CLK to CMD change	t_{IH}		1.5	—	—	ns
Output delay time, SD_CLK to CMD valid	t_{ODLY}		—	—	29.6	ns
Output hold time, SD_CLK to CMD change	t_{OH}		2.0	—	—	ns
Input setup time, DAT[0:3] valid to SD_CLK	t_{ISU2X}		14.1	—	—	ns
Input hold time, SD_CLK to DAT[0:3] change	t_{IH2X}		1.5	—	—	ns
Output delay time, SD_CLK to DAT[0:3] valid	t_{ODLY2X}		—	—	36.2	ns
Output hold time, SD_CLK to DAT[0:3] change	t_{OH2X}		2.0	—	—	ns

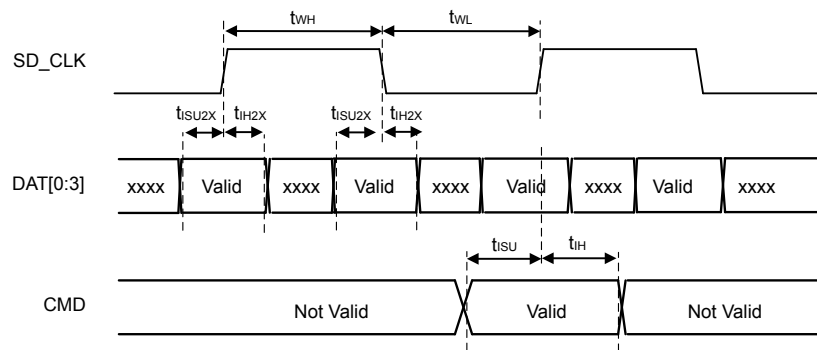

Input Timing

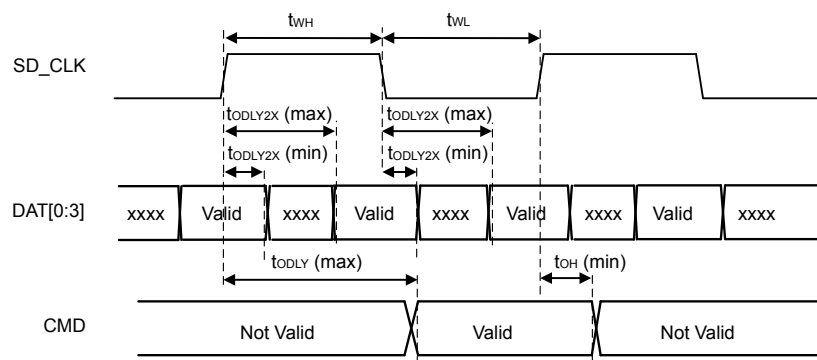

Output Timing

Figure 4.16. SDIO DDR Mode Timing

SDIO MMC Legacy Mode Timing

Timing is specified with voltage scaling disabled. Slew rate for SD_CLK set to 7, all other GPIO set to 6, DRIVESTRENGTH = STRONG for all pins. SDIO_CTRL_TXDLYMUXSEL = 1. Loading between 5 and 10 pF on all pins or between 10 and 20 pF on all pins.

Table 4.54. SDIO MMC Legacy Mode Timing (Location 0)

Parameter	Symbol	Test Condition	Min	Typ	Max	Unit
Clock frequency during data transfer	F _{SD_CLK}	Using HFRCO, AUXHFRCO, or USHFRCO	—	—	26	MHz
		Using HFXO	—	—	26	MHz
Clock low time	t _{WL}	Using HFRCO, AUXHFRCO, or USHFRCO	17.3	—	—	ns
		Using HFXO	14.9	—	—	ns
Clock high time	t _{WH}	Using HFRCO, AUXHFRCO, or USHFRCO	17.3	—	—	ns
		Using HFXO	14.9	—	—	ns
Clock rise time	t _R		0.8	—	6.6	ns
Input setup time, CMD, DAT[0:7] valid to SD_CLK	t _{ISU}		5.1	—	—	ns
Input hold time, SD_CLK to CMD, DAT[0:7] change	t _{IH}		2.5	—	—	ns
Output delay time, SD_CLK to CMD, DAT[0:7] valid	t _{ODLY}		—	—	17.7	ns
Output hold time, SD_CLK to CMD, DAT[0:7] change	t _{OH}		3	—	—	ns

Table 4.55. SDIO MMC Legacy Mode Timing (Location 1)

Parameter	Symbol	Test Condition	Min	Typ	Max	Unit
Clock frequency during data transfer	F _{SD_CLK}	Using HFRCO, AUXHFRCO, or USHFRCO	—	—	23	MHz
		Using HFXO	—	—	23	MHz
Clock low time	t _{WL}	Using HFRCO, AUXHFRCO, or USHFRCO	19.6	—	—	ns
		Using HFXO	16.9	—	—	ns
Clock high time	t _{WH}	Using HFRCO, AUXHFRCO, or USHFRCO	19.6	—	—	ns
		Using HFXO	16.9	—	—	ns
Clock rise time	t _R		0.8	—	6.6	ns
Input setup time, CMD, DAT[0:7] valid to SD_CLK	t _{ISU}		6.1	—	—	ns
Input hold time, SD_CLK to CMD, DAT[0:7] change	t _{IH}		2.5	—	—	ns
Output delay time, SD_CLK to CMD, DAT[0:7] valid	t _{ODLY}		—	—	29.7	ns

Parameter	Symbol	Test Condition	Min	Typ	Max	Unit
Output hold time, SD_CLK to CMD, DAT[0:7] change	t_{OH}		3	—	—	ns



Figure 4.17. SDIO MMC Legacy Mode Timing

SDIO MMC SDR Mode Timing at 1.8 V

Timing is specified at 1.62 V IOVDD with voltage scaling disabled. Slew rate for SD_CLK set to 7, all other GPIO set to 6, DRIVES-TRENGTH = STRONG for all pins. SDIO_CTRL_TXDLYMUXSEL = 1. Loading between 5 and 10 pF, between 10 and 20 pF, or between 20 and 30 pF on all pins.

Table 4.56. SDIO MMC SDR Mode Timing (Location 0, 1.62 V I/O)

Parameter	Symbol	Test Condition	Min	Typ	Max	Unit
Clock frequency during data transfer	F _{SD_CLK}	Using HFRCO, AUXHFRCO, or USHFRCO	—	—	26	MHz
		Using HFXO	—	—	26	MHz
Clock low time	t _{WL}	Using HFRCO, AUXHFRCO, or USHFRCO	17.3	—	—	ns
		Using HFXO	14.9	—	—	ns
Clock high time	t _{WH}	Using HFRCO, AUXHFRCO, or USHFRCO	17.3	—	—	ns
		Using HFXO	14.9	—	—	ns
Clock rise time	t _R		1.1	—	6.6	ns
Input setup time, CMD, DAT[0:7] valid to SD_CLK	t _{ISU}		5.1	—	—	ns
Input hold time, SD_CLK to CMD, DAT[0:7] change	t _{IH}		2.5	—	—	ns
Output delay time, SD_CLK to CMD, DAT[0:7] valid	t _{ODLY}		—	—	17.7	ns
Output hold time, SD_CLK to CMD, DAT[0:7] change	t _{OH}		3	—	—	ns

Table 4.57. SDIO MMC SDR Mode Timing (Location 1, 1.62 V I/O)

Parameter	Symbol	Test Condition	Min	Typ	Max	Unit
Clock frequency during data transfer	F _{SD_CLK}	Using HFRCO, AUXHFRCO, or USHFRCO	—	—	23	MHz
		Using HFXO	—	—	23	MHz
Clock low time	t _{WL}	Using HFRCO, AUXHFRCO, or USHFRCO	19.6	—	—	ns
		Using HFXO	16.9	—	—	ns
Clock high time	t _{WH}	Using HFRCO, AUXHFRCO, or USHFRCO	19.6	—	—	ns
		Using HFXO	16.9	—	—	ns
Clock rise time	t _R		1.1	—	6.6	ns
Input setup time, CMD, DAT[0:7] valid to SD_CLK	t _{ISU}		6.1	—	—	ns
Input hold time, SD_CLK to CMD, DAT[0:7] change	t _{IH}		2.5	—	—	ns

Parameter	Symbol	Test Condition	Min	Typ	Max	Unit
Output delay time, SD_CLK to CMD, DAT[0:7] valid	t_{ODLY}		—	—	29.7	ns
Output hold time, SD_CLK to CMD, DAT[0:7] change	t_{OH}		3	—	—	ns

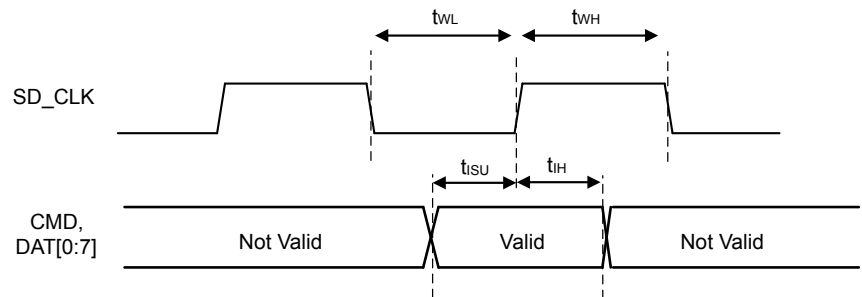

Input Timing

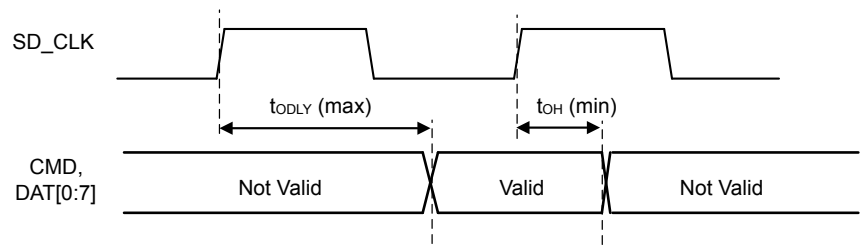

Output Timing

Figure 4.18. SDIO MMC SDR Mode Timing

SDIO MMC SDR Mode Timing at 3.0 V

Timing is specified at 3.0 V IOVDD with voltage scaling disabled. Slew rate for SD_CLK set to 7, all other GPIO set to 6, DRIVES-TRENGTH = STRONG for all pins. SDIO_CTRL_TXDLYMUXSEL = 1. Loading between 5 and 10 pF on all pins or between 10 and 20 pF on all pins.

Table 4.58. SDIO MMC SDR Mode Timing (Location 0, 3 V I/O)

Parameter	Symbol	Test Condition	Min	Typ	Max	Unit
Clock frequency during data transfer	F _{SD_CLK}	Using HFRCO, AUXHFRCO, or USHFRCO	—	—	50	MHz
		Using HFXO	—	—	50	MHz
Clock low time	t _{WL}	Using HFRCO, AUXHFRCO, or USHFRCO	9	—	—	ns
		Using HFXO	7.6	—	—	ns
Clock high time	t _{WH}	Using HFRCO, AUXHFRCO, or USHFRCO	9	—	—	ns
		Using HFXO	7.6	—	—	ns
Clock rise time	t _R		0.8	—	2.5	ns
Input setup time, CMD, DAT[0:7] valid to SD_CLK	t _{ISU}		3.4	—	—	ns
Input hold time, SD_CLK to CMD, DAT[0:7] change	t _{IH}		2.5	—	—	ns
Output delay time, SD_CLK to CMD, DAT[0:7] valid	t _{ODLY}		—	—	14	ns
Output hold time, SD_CLK to CMD, DAT[0:7] change	t _{OH}		3	—	—	ns

Table 4.59. SDIO MMC SDR Mode Timing (Location 1, 3 V I/O)

Parameter	Symbol	Test Condition	Min	Typ	Max	Unit
Clock frequency during data transfer	F _{SD_CLK}	Using HFRCO, AUXHFRCO, or USHFRCO	—	—	32	MHz
		Using HFXO	—	—	32	MHz
Clock low time	t _{WL}	Using HFRCO, AUXHFRCO, or USHFRCO	14.1	—	—	ns
		Using HFXO	12.1	—	—	ns
Clock high time	t _{WH}	Using HFRCO, AUXHFRCO, or USHFRCO	14.1	—	—	ns
		Using HFXO	12.1	—	—	ns
Clock rise time	t _R		0.8	—	2.5	ns
Input setup time, CMD, DAT[0:7] valid to SD_CLK	t _{ISU}		5.2	—	—	ns
Input hold time, SD_CLK to CMD, DAT[0:7] change	t _{IH}		2.5	—	—	ns

Parameter	Symbol	Test Condition	Min	Typ	Max	Unit
Output delay time, SD_CLK to CMD, DAT[0:7] valid	t_{ODLY}		—	—	24.9	ns
Output hold time, SD_CLK to CMD, DAT[0:7] change	t_{OH}		3	—	—	ns



Input Timing



Output Timing

Figure 4.19. SDIO MMC SDR Mode Timing

SDIO MMC DDR Mode Timing at 1.8 V

Timing is specified at 1.62 V IOVDD with voltage scaling disabled. Slew rate for SD_CLK set to 7, all other GPIO set to 6, DRIVES-TRENGTH = STRONG for all pins. SDIO_CTRL_TXDLYMUXSEL = 1. Loading between 5 and 10 pF on all pins or between 10 and 25 pF on all pins.

Table 4.60. SDIO MMC DDR Mode Timing (Location 0, 1.62 V I/O)

Parameter	Symbol	Test Condition	Min	Typ	Max	Unit
Clock frequency during data transfer	F _{SD_CLK}	Using HFRCO, AUXHFRCO, or USHFRCO	—	—	18	MHz
		Using HFXO	—	—	15.5	MHz
Clock low time	t _{WL}	Using HFRCO, AUXHFRCO, or USHFRCO	25.1	—	—	ns
		Using HFXO	25.4	—	—	ns
Clock high time	t _{WH}	Using HFRCO, AUXHFRCO, or USHFRCO	25.1	—	—	ns
		Using HFXO	25.4	—	—	ns
Clock rise time	t _R		0.8	—	6.1	ns
Clock fall time	t _F		0.7	—	4.7	ns
Input setup time, CMD valid to SD_CLK	t _{ISU}		3.8	—	—	ns
Input hold time, SD_CLK to CMD change	t _{IH}		2.5	—	—	ns
Output delay time, SD_CLK to CMD valid	t _{ODLY}		—	—	20.1	ns
Output hold time, SD_CLK to CMD change	t _{OH}		3	—	—	ns
Input setup time, DAT[0:7] valid to SD_CLK	t _{ISU2X}		7.4	—	—	ns
Input hold time, SD_CLK to DAT[0:7] change	t _{IH2X}		2.5	—	—	ns
Output delay time, SD_CLK to DAT[0:7] valid	t _{ODLY2X}		—	—	22.7	ns
Output hold time, SD_CLK to DAT[0:7] change	t _{OH2X}		3	—	—	ns

Table 4.61. SDIO MMC DDR Mode Timing (Location 1, 1.62 V I/O)

Parameter	Symbol	Test Condition	Min	Typ	Max	Unit
Clock frequency during data transfer	F _{SD_CLK}	Using HFRCO, AUXHFRCO, or USHFRCO	—	—	12.5	MHz
		Using HFXO	—	—	11	MHz
Clock low time	t _{WL}	Using HFRCO, AUXHFRCO, or USHFRCO	36.1	—	—	ns
		Using HFXO	35.9	—	—	ns

Parameter	Symbol	Test Condition	Min	Typ	Max	Unit
Clock high time	t_{WH}	Using HFRCO, AUXHFRCO, or USHFRCO	36.1	—	—	ns
		Using HFXO	35.9	—	—	ns
Clock rise time	t_R		0.8	—	6.1	ns
Clock fall time	t_F		0.7	—	4.7	ns
Input setup time, CMD valid to SD_CLK	t_{ISU}		13.7	—	—	ns
Input hold time, SD_CLK to CMD change	t_{IH}		2.5	—	—	ns
Output delay time, SD_CLK to CMD valid	t_{ODLY}		—	—	33.1	ns
Output hold time, SD_CLK to CMD change	t_{OH}		3	—	—	ns
Input setup time, DAT[0:7] valid to SD_CLK	t_{ISU2X}		16.4	—	—	ns
Input hold time, SD_CLK to DAT[0:7] change	t_{IH2X}		2.5	—	—	ns
Output delay time, SD_CLK to DAT[0:7] valid	t_{ODLY2X}		—	—	40.4	ns
Output hold time, SD_CLK to DAT[0:7] change	t_{OH2X}		3	—	—	ns



Input Timing



Output Timing

Figure 4.20. SDIO MMC DDR Mode Timing

SDIO MMC DDR Mode Timing at 3.0 V

Timing is specified at 3.0 V IOVDD with voltage scaling disabled. Slew rate for SD_CLK set to 7, all other GPIO set to 6, DRIVES-TRENGTH = STRONG for all pins. SDIO_CTRL_TXDLYMUXSEL = 1. Loading between 5 and 10 pF on all pins or between 10 and 25 pF on all pins.

Table 4.62. SDIO MMC DDR Mode Timing (Location 0, 3 V I/O)

Parameter	Symbol	Test Condition	Min	Typ	Max	Unit
Clock frequency during data transfer	F _{SD_CLK}	Using HFRCO, AUXHFRCO, or USHFRCO	—	—	20	MHz
		Using HFXO	—	—	17.5	MHz
Clock low time	t _{WL}	Using HFRCO, AUXHFRCO, or USHFRCO	22.6	—	—	ns
		Using HFXO	22.4	—	—	ns
Clock high time	t _{WH}	Using HFRCO, AUXHFRCO, or USHFRCO	22.6	—	—	ns
		Using HFXO	22.4	—	—	ns
Clock rise time	t _R		0.8	—	2.8	ns
Clock fall time	t _F		0.7	—	2.4	ns
Input setup time, CMD valid to SD_CLK	t _{ISU}		7.1	—	—	ns
Input hold time, SD_CLK to CMD change	t _{IH}		2.5	—	—	ns
Output delay time, SD_CLK to CMD valid	t _{ODLY}		—	—	20.7	ns
Output hold time, SD_CLK to CMD change	t _{OH}		3	—	—	ns
Input setup time, DAT[0:7] valid to SD_CLK	t _{ISU2X}		10.1	—	—	ns
Input hold time, SD_CLK to DAT[0:7] change	t _{IH2X}		2.5	—	—	ns
Output delay time, SD_CLK to DAT[0:7] valid	t _{ODLY2X}		—	—	23.7	ns
Output hold time, SD_CLK to DAT[0:7] change	t _{OH2X}		3	—	—	ns

Table 4.63. SDIO MMC DDR Mode Timing (Location 1, 3 V I/O)

Parameter	Symbol	Test Condition	Min	Typ	Max	Unit
Clock frequency during data transfer	F _{SD_CLK}	Using HFRCO, AUXHFRCO, or USHFRCO	—	—	12.5	MHz
		Using HFXO	—	—	11.5	MHz
Clock low time	t _{WL}	Using HFRCO, AUXHFRCO, or USHFRCO	36.1	—	—	ns
		Using HFXO	34.3	—	—	ns

Parameter	Symbol	Test Condition	Min	Typ	Max	Unit
Clock high time	t_{WH}	Using HFRCO, AUXHFRCO, or USHFRCO	36.1	—	—	ns
		Using HFXO	34.3	—	—	ns
Clock rise time	t_R		0.8	—	2.8	ns
Clock fall time	t_F		0.7	—	2.4	ns
Input setup time, CMD valid to SD_CLK	t_{ISU}		11.6	—	—	ns
Input hold time, SD_CLK to CMD change	t_{IH}		2.5	—	—	ns
Output delay time, SD_CLK to CMD valid	t_{ODLY}		—	—	29.3	ns
Output hold time, SD_CLK to CMD change	t_{OH}		3	—	—	ns
Input setup time, DAT[0:7] valid to SD_CLK	t_{ISU2X}		14.7	—	—	ns
Input hold time, SD_CLK to DAT[0:7] change	t_{IH2X}		2.5	—	—	ns
Output delay time, SD_CLK to DAT[0:7] valid	t_{ODLY2X}		—	—	38.6	ns
Output hold time, SD_CLK to DAT[0:7] change	t_{OH2X}		3	—	—	ns



Input Timing



Output Timing

Figure 4.21. SDIO MMC DDR Mode Timing

4.1.28 Quad SPI (QSPI)

4.1.28.1 QSPI SDR Mode

QSPI SDR Mode Timing (Location 0)

Timing is specified with voltage scaling disabled, PHY-mode, route location 0 only, TX DLL = 25, RX DLL = 61, 5-25 pF loading per GPIO, and slew rate for all GPIO set to 6, DRIVESTRENGTH = STRONG.

Table 4.64. QSPI SDR Mode Timing (Location 0)

Parameter	Symbol	Test Condition	Min	Typ	Max	Unit
Full SCLK period	T		$(1/F_{SCLK})^*$ 0.95	—	—	ns
Output valid	t_{OV}		—	—	T/2 - 2.3	ns
Output hold	t_{OH}		T/2 - 34.1	—	—	ns
Input setup	t_{SU}		29.8 - T/2	—	—	ns
Input hold	t_H		T/2 - 0.5	—	—	ns

QSPI SDR Mode Timing (Optimal Conditions)

Timing is specified at IOVDD ≥ 3.0V, using internal HFRCO oscillator and with voltage scaling disabled, PHY-mode, route location 0 only, TX DLL = 25, RX DLL = 43, 5-25 pF loading per GPIO, and slew rate for all GPIO set to 6, DRIVESTRENGTH = STRONG.

Table 4.65. QSPI SDR Mode Timing (Optimized at 3.0V, Location 0)

Parameter	Symbol	Test Condition	Min	Typ	Max	Unit
Full SCLK period	T		$(1/F_{SCLK})^*$ 0.95	—	—	ns
Output valid	t_{OV}		—	—	T/2 - 2.4	ns
Output hold	t_{OH}		T/2 - 24.7	—	—	ns
Input setup	t_{SU}		21.9 - T/2	—	—	ns
Input hold	t_H		T/2 - 4.6	—	—	ns

QSPI SDR Mode Timing (Locations 1, 2)

Timing is specified with voltage scaling disabled, PHY-mode, route locations other than 0, TX DLL = 37, RX DLL = 79, 5-25 pF loading per GPIO, and slew rate for all GPIO set to 6, DRIVESTRENGTH = STRONG.

Table 4.66. QSPI SDR Mode Timing (Locations 1, 2)

Parameter	Symbol	Test Condition	Min	Typ	Max	Unit
Full SCLK period	T		$(1/F_{SCLK}) * 0.95$	—	—	ns
Output valid	t_{OV}		—	—	T/2 - 2.0	ns
Output hold	t_{OH}		T/2 - 44.1	—	—	ns
Input setup	t_{SU}		38.2 - T/2	—	—	ns
Input hold	t_H		T/2 - 0.8	—	—	ns

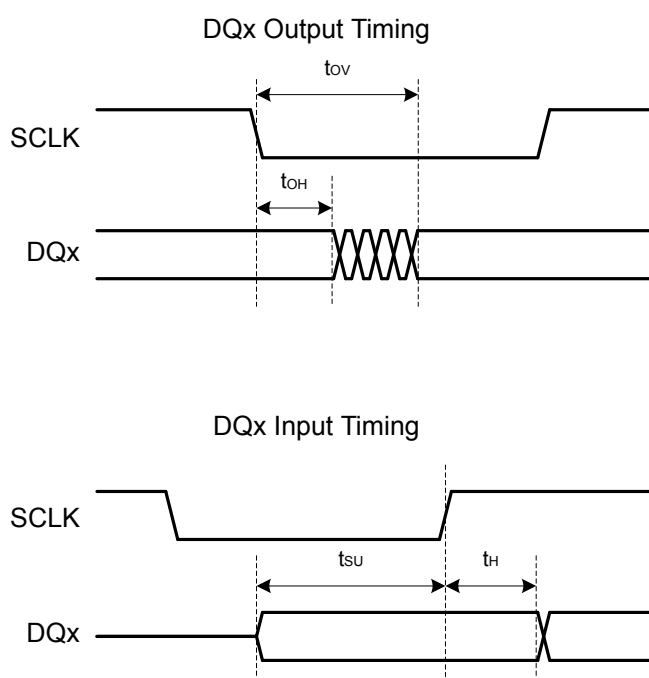

Figure 4.22. QSPI SDR Timing Diagrams

QSPI SDR Flash Timing Example

This example uses timing values from SDR Mode Timing (Optimal Conditions) to demonstrate the calculation of allowable flash timing using the QSPI in SDR mode.

- Using a configured SCLK frequency (F_{SCLK}) of 33 MHz:
- The resulting minimum period, $T(\min) = (1/F_{SCLK}) * 0.95 = 28.8$ ns.
- Flash will see a minimum setup time of $T/2 - t_{OV} = T/2 - (T/2 - 2.4) = 2.4$ ns.
- Flash will see a minimum hold time of $T/2 + t_{OH} = T/2 + (T/2 - 24.7) = T - 24.7 = 28.8 - 24.7 = 4.1$ ns.
- Flash can have a maximum output valid time of $T/2 - t_{SU} = T/2 - (21.9 - T/2) = T - 21.9 = 28.8 - 21.9 = 6.9$ ns.
- Flash can have a minimum output hold time of $t_H - T/2 = (T/2 - 4.6) - T/2 = -4.6$ ns.

4.1.28.2 QSPI DDR Mode

QSPI DDR Mode Timing (Location 0)

Timing is specified with voltage scaling disabled, PHY-mode, route location 0 only, TX DLL = 35, RX DLL = 69, 5-25 pF loading per GPIO, and slew rate for all GPIO set to 6, DRIVESTRENGTH = STRONG.

Table 4.67. QSPI DDR Mode Timing (Location 0)

Parameter	Symbol	Test Condition	Min	Typ	Max	Unit
Half SCLK period	T/2	HFXO	(1/F _{SCLK}) * 0.4 - 0.4	—	—	ns
		HFRCO, AUXHFRCO, USHFRCO	(1/F _{SCLK}) * 0.44	—	—	ns
Output valid	t _{OV}		—	—	T/2 - 4.5	ns
Output hold	t _{OH}		T/2 - 39.4	—	—	ns
Input setup	t _{SU}		33.7	—	—	ns
Input hold	t _H		-0.8	—	—	ns

QSPI DDR Mode Timing (Optimal Conditions)

Timing is specified at IOVDD ≥ 3.0V, using internal HFRCO oscillator and with voltage scaling disabled, PHY-mode, route location 0 only, TX DLL = 26, RX DLL = 60, 5-25 pF loading per GPIO, and slew rate for all GPIO set to 6, DRIVESTRENGTH = STRONG.

Table 4.68. QSPI DDR Mode Timing (Optimized at 3.0V, Location 0)

Parameter	Symbol	Test Condition	Min	Typ	Max	Unit
Half SCLK period	T/2	HFRCO, AUXHFRCO, USHFRCO	(1/F _{SCLK}) * 0.44	—	—	ns
Output valid	t _{OV}		—	—	T/2 - 2.5	ns
Output hold	t _{OH}		T/2 - 24.3	—	—	ns
Input setup	t _{SU}		14.4	—	—	ns
Input hold	t _H		-0.9	—	—	ns

QSPI DDR Mode Timing (Locations 1, 2)

Timing is specified with voltage scaling disabled, PHY-mode, route locations other than 0, TX DLL = 39, RX DLL = 84, 5-25 pF loading per GPIO, and slew rate for all GPIO set to 6, DRIVESTRENGTH = STRONG.

Table 4.69. QSPI DDR Mode Timing (Locations 1, 2)

Parameter	Symbol	Test Condition	Min	Typ	Max	Unit
Half SCLK period	T/2	HFXO	$(1/F_{SCLK})^*$ 0.4 - 0.4	—	—	ns
		HFRCO, AUXHFRCO, USHFRCO	$(1/F_{SCLK})^*$ 0.44	—	—	ns
Output valid	t_{OV}		—	—	T/2 - 3.0	ns
Output hold	t_{OH}		T/2 - 43.5	—	—	ns
Input setup	t_{SU}		38.4	—	—	ns
Input hold	t_H		0.0	—	—	ns



Figure 4.23. QSPI DDR Timing Diagrams

QSPI DDR Flash Timing Example

This example uses timing values for DDR Mode Timing (Optimal Conditions) to demonstrate the calculation of allowable flash timing using the QSPI in DDR mode.

- Using a configured SCLK frequency (F_{SCLK}) of 17 MHz from the HFXO clock source:
- The resulting minimum half-period, $T/2(\min) = (1/F_{SCLK}) * 0.44 = 25.9$ ns.
- Flash will see a minimum setup time of $T/2 - t_{OV} = T/2 - (T/2 - 2.5) = 2.5$ ns.
- Flash will see a minimum hold time of $t_{OH} = T/2 - 24.3 = 25.9 - 24.3 = 1.6$ ns.
- Flash can have a maximum output valid time of $T/2 - t_{SU} = T/2 - 14.4 = 25.9 - 14.4 = 11.5$ ns.
- Flash can have a minimum output hold time of $t_H = - 0.9$ ns.

4.2 Typical Performance Curves

Typical performance curves indicate typical characterized performance under the stated conditions.

4.2.1 Supply Current



Figure 4.24. EM0 Full Speed Active Mode Typical Supply Current vs. Temperature



Figure 4.25. EM0 Active Mode Typical Supply Current vs. Temperature



Figure 4.26. EM1 Sleep Mode Typical Supply Current vs. Temperature

Typical supply current for EM2, EM3 and EM4H using standard software libraries from Silicon Laboratories.



Figure 4.27. EM2, EM3, EM4H and EM4S Typical Supply Current vs. Temperature

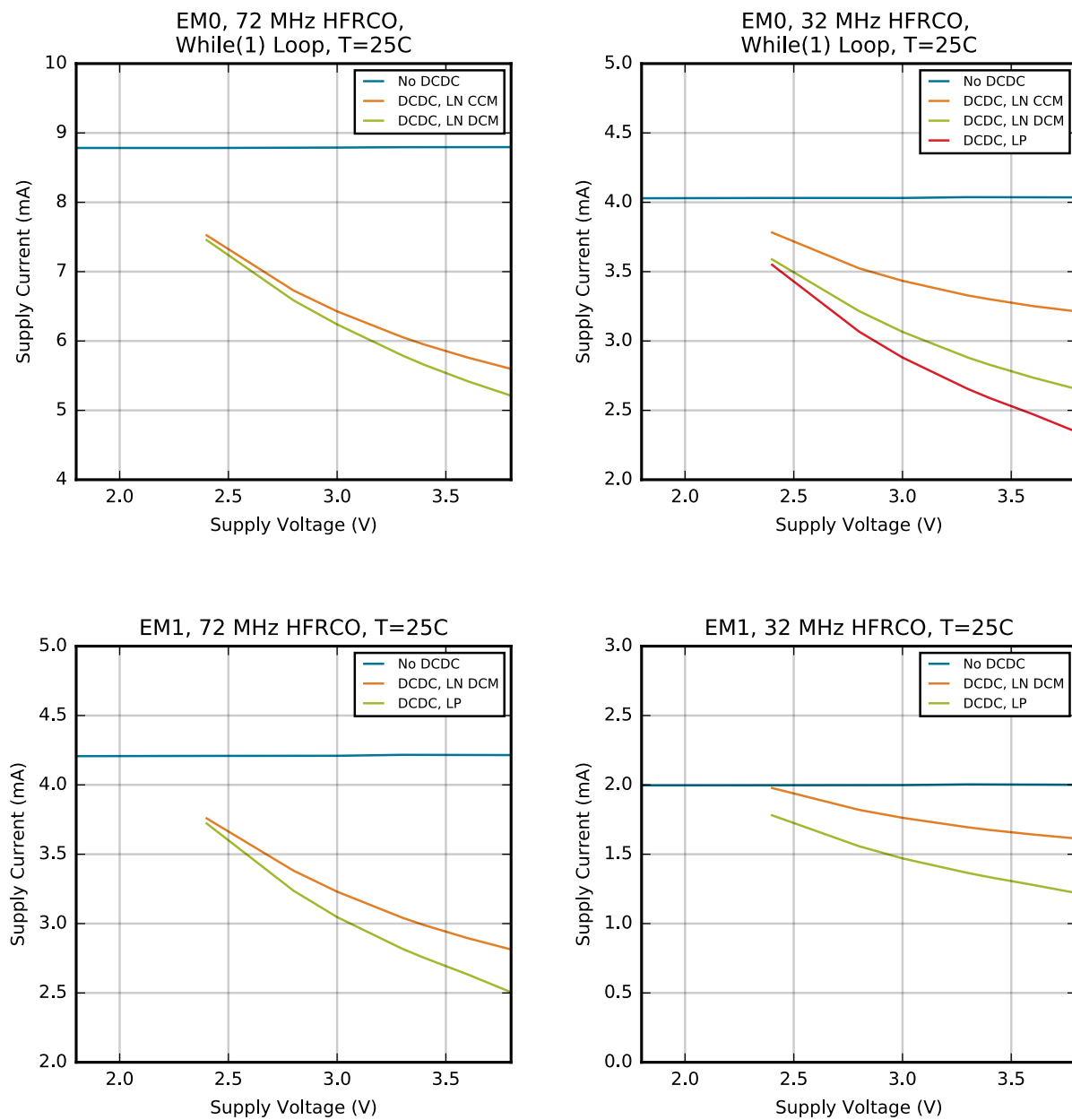

Figure 4.28. EM0 and EM1 Mode Typical Supply Current vs. Supply

Typical supply current for EM2, EM3 and EM4H using standard software libraries from Silicon Laboratories.



Figure 4.29. EM2, EM3, EM4H and EM4S Typical Supply Current vs. Supply

4.2.2 DC-DC Converter

Default test conditions: CCM mode, LDCDC = 4.7 μ H, CDCDC = 4.7 μ F, VDCDC_I = 3.3 V, VDCDC_O = 1.8 V, FDCDC_LN = 7 MHz



Figure 4.30. DC-DC Converter Typical Performance Characteristics



Figure 4.31. DC-DC Converter Transition Waveforms

5. Pin Definitions

5.1 EFM32GG11B8xx in BGA192 Device Pinout

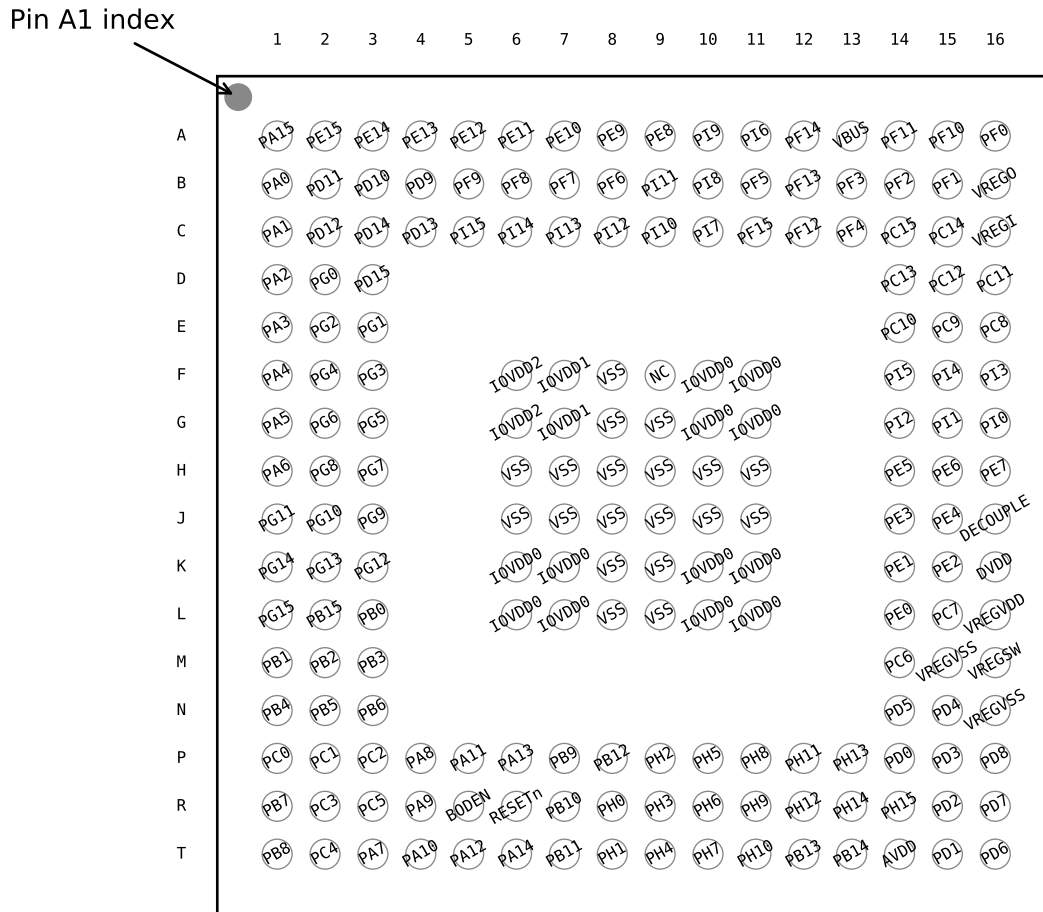

Figure 5.1. EFM32GG11B8xx in BGA192 Device Pinout

The following table provides package pin connections and general descriptions of pin functionality. For detailed information on the supported features for each GPIO pin, see [5.20 GPIO Functionality Table](#) or [5.21 Alternate Functionality Overview](#).

Table 5.1. EFM32GG11B8xx in BGA192 Device Pinout

Pin Name	Pin(s)	Description	Pin Name	Pin(s)	Description
PA15	A1	GPIO	PE15	A2	GPIO
PE14	A3	GPIO	PE13	A4	GPIO
PE12	A5	GPIO	PE11	A6	GPIO
PE10	A7	GPIO	PE9	A8	GPIO
PE8	A9	GPIO	PI9	A10	GPIO (5V)
PI6	A11	GPIO (5V)	PF14	A12	GPIO (5V)

Pin Name	Pin(s)	Description	Pin Name	Pin(s)	Description
VBUS	A13	USB VBUS signal and auxiliary input to 5 V regulator.	PF11	A14	GPIO (5V)
PF10	A15	GPIO (5V)	PF0	A16	GPIO (5V)
PA0	B1	GPIO	PD11	B2	GPIO
PD10	B3	GPIO	PD9	B4	GPIO
PF9	B5	GPIO	PF8	B6	GPIO
PF7	B7	GPIO	PF6	B8	GPIO
PI11	B9	GPIO (5V)	PI8	B10	GPIO (5V)
PF5	B11	GPIO	PF13	B12	GPIO (5V)
PF3	B13	GPIO	PF2	B14	GPIO
PF1	B15	GPIO (5V)	VREGO	B16	Decoupling for 5 V regulator and regulator output. Power for USB PHY in USB-enabled OPNs
PA1	C1	GPIO	PD12	C2	GPIO
PD14	C3	GPIO (5V)	PD13	C4	GPIO (5V)
PI15	C5	GPIO (5V)	PI14	C6	GPIO (5V)
PI13	C7	GPIO (5V)	PI12	C8	GPIO (5V)
PI10	C9	GPIO (5V)	PI7	C10	GPIO (5V)
PF15	C11	GPIO (5V)	PF12	C12	GPIO
PF4	C13	GPIO	PC15	C14	GPIO (5V)
PC14	C15	GPIO (5V)	VREGI	C16	Input to 5 V regulator.
PA2	D1	GPIO	PG0	D2	GPIO (5V)
PD15	D3	GPIO (5V)	PC13	D14	GPIO (5V)
PC12	D15	GPIO (5V)	PC11	D16	GPIO (5V)
PA3	E1	GPIO	PG2	E2	GPIO (5V)
PG1	E3	GPIO (5V)	PC10	E14	GPIO (5V)
PC9	E15	GPIO (5V)	PC8	E16	GPIO (5V)
PA4	F1	GPIO	PG4	F2	GPIO (5V)
PG3	F3	GPIO (5V)	IOVDD2	F6 G6	Digital IO power supply 2.

Pin Name	Pin(s)	Description	Pin Name	Pin(s)	Description
IOVDD1	F7 G7	Digital IO power supply 1.	VSS	F8 G8 G9 H6 H7 H8 H9 H10 H11 J6 J7 J8 J9 J10 J11 K8 K9 L8 L9	Ground
NC	F9	No Connect.	IOVDD0	F10 F11 G10 G11 K6 K7 K10 K11 L6 L7 L10 L11	Digital IO power supply 0.
PI5	F14	GPIO (5V)	PI4	F15	GPIO (5V)
PI3	F16	GPIO (5V)	PA5	G1	GPIO
PG6	G2	GPIO (5V)	PG5	G3	GPIO (5V)
PI2	G14	GPIO (5V)	PI1	G15	GPIO (5V)
PI0	G16	GPIO (5V)	PA6	H1	GPIO
PG8	H2	GPIO (5V)	PG7	H3	GPIO (5V)
PE5	H14	GPIO	PE6	H15	GPIO
PE7	H16	GPIO	PG11	J1	GPIO (5V)
PG10	J2	GPIO (5V)	PG9	J3	GPIO (5V)
PE3	J14	GPIO	PE4	J15	GPIO
DECOUPLE	J16	Decouple output for on-chip voltage regulator. An external decoupling capacitor is required at this pin.	PG14	K1	GPIO
PG13	K2	GPIO	PG12	K3	GPIO
PE1	K14	GPIO (5V)	PE2	K15	GPIO
DVDD	K16	Digital power supply.	PG15	L1	GPIO (5V)
PB15	L2	GPIO (5V)	PB0	L3	GPIO
PE0	L14	GPIO (5V)	PC7	L15	GPIO
VREGVDD	L16	Voltage regulator VDD input	PB1	M1	GPIO

Pin Name	Pin(s)	Description	Pin Name	Pin(s)	Description
PB2	M2	GPIO	PB3	M3	GPIO
PC6	M14	GPIO	VREGVSS	M15 N16	Voltage regulator VSS
VREGSW	M16	DCDC regulator switching node	PB4	N1	GPIO
PB5	N2	GPIO	PB6	N3	GPIO
PD5	N14	GPIO	PD4	N15	GPIO
PC0	P1	GPIO (5V)	PC1	P2	GPIO (5V)
PC2	P3	GPIO (5V)	PA8	P4	GPIO
PA11	P5	GPIO	PA13	P6	GPIO (5V)
PB9	P7	GPIO (5V)	PB12	P8	GPIO
PH2	P9	GPIO (5V)	PH5	P10	GPIO
PH8	P11	GPIO (5V)	PH11	P12	GPIO (5V)
PH13	P13	GPIO (5V)	PD0	P14	GPIO (5V)
PD3	P15	GPIO	PD8	P16	GPIO
PB7	R1	GPIO	PC3	R2	GPIO (5V)
PC5	R3	GPIO	PA9	R4	GPIO
BODEN	R5	Brown-Out Detector Enable. This pin may be left disconnected or tied to AVDD.	RESETn	R6	Reset input, active low. To apply an external reset source to this pin, it is required to only drive this pin low during reset, and let the internal pull-up ensure that reset is released.
PB10	R7	GPIO (5V)	PH0	R8	GPIO (5V)
PH3	R9	GPIO (5V)	PH6	R10	GPIO
PH9	R11	GPIO (5V)	PH12	R12	GPIO (5V)
PH14	R13	GPIO (5V)	PH15	R14	GPIO (5V)
PD2	R15	GPIO (5V)	PD7	R16	GPIO
PB8	T1	GPIO	PC4	T2	GPIO
PA7	T3	GPIO	PA10	T4	GPIO
PA12	T5	GPIO (5V)	PA14	T6	GPIO
PB11	T7	GPIO	PH1	T8	GPIO (5V)
PH4	T9	GPIO	PH7	T10	GPIO (5V)
PH10	T11	GPIO (5V)	PB13	T12	GPIO
PB14	T13	GPIO	AVDD	T14	Analog power supply.
PD1	T15	GPIO	PD6	T16	GPIO

Note:

1. GPIO with 5V tolerance are indicated by (5V).
2. The pins PD13, PD14, and PD15 will not be 5V tolerant on all future devices. In order to preserve upgrade options with full hardware compatibility, do not use these pins with 5V domains.

5.2 EFM32GG11B8xx in BGA152 Device Pinout



Figure 5.2. EFM32GG11B8xx in BGA152 Device Pinout

The following table provides package pin connections and general descriptions of pin functionality. For detailed information on the supported features for each GPIO pin, see [5.20 GPIO Functionality Table](#) or [5.21 Alternate Functionality Overview](#).

Table 5.2. EFM32GG11B8xx in BGA152 Device Pinout

Pin Name	Pin(s)	Description	Pin Name	Pin(s)	Description
PE15	A1	GPIO	PE13	A2	GPIO
PE11	A3	GPIO	PE9	A4	GPIO
PD12	A5	GPIO	PD10	A6	GPIO
PF9	A7	GPIO	PF7	A8	GPIO
PF13	A9	GPIO (5V)	VBUS	A10	USB VBUS signal and auxiliary input to 5 V regulator.
PF1	A11	GPIO (5V)	PC15	A12	GPIO (5V)
PF11	A13	GPIO (5V)	PF10	A14	GPIO (5V)

Pin Name	Pin(s)	Description	Pin Name	Pin(s)	Description
PA15	B1	GPIO	PE14	B2	GPIO
PE12	B3	GPIO	PE8	B4	GPIO
PD11	B5	GPIO	PD9	B6	GPIO
PF8	B7	GPIO	PF6	B8	GPIO
PF14	B9	GPIO (5V)	PF12	B10	GPIO
PF2	B11	GPIO	PF0	B12	GPIO (5V)
PC14	B13	GPIO (5V)	VREGO	B14	Decoupling for 5 V regulator and regulator output. Power for USB PHY in USB-enabled OPNs
PA1	C1	GPIO	PA0	C2	GPIO
PD13	C3	GPIO (5V)	PE10	C4	GPIO
PI8	C5	GPIO (5V)	PI7	C6	GPIO (5V)
PI6	C7	GPIO (5V)	PF5	C8	GPIO
PF15	C9	GPIO (5V)	PF4	C10	GPIO
PF3	C11	GPIO	PC13	C12	GPIO (5V)
PC12	C13	GPIO (5V)	VREGI	C14	Input to 5 V regulator.
PA3	D1	GPIO	PA2	D2	GPIO
PD14	D3	GPIO (5V)	PC11	D12	GPIO (5V)
PC10	D13	GPIO (5V)	PC9	D14	GPIO (5V)
PA5	E1	GPIO	PA4	E2	GPIO
PD15	E3	GPIO (5V)	IOVDD1	E6	Digital IO power supply 1.
VSS	E7 E8 G5 G7 G8 G10 H5 H7 H8 H10 K7 K8	Ground	IOVDD0	E9 F10 J5 J10 K6 K9	Digital IO power supply 0.
PC8	E12	GPIO (5V)	PI5	E13	GPIO (5V)
PI4	E14	GPIO (5V)	PG0	F1	GPIO (5V)
PA6	F2	GPIO	PG1	F3	GPIO (5V)
IOVDD2	F5	Digital IO power supply 2.	PI3	F12	GPIO (5V)
PI2	F13	GPIO (5V)	PI1	F14	GPIO (5V)
PG3	G1	GPIO (5V)	PG4	G2	GPIO (5V)
PG2	G3	GPIO (5V)	PE7	G12	GPIO
PI0	G13	GPIO (5V)	DECOUPLE	G14	Decouple output for on-chip voltage regulator. An external decoupling capacitor is required at this pin.

Pin Name	Pin(s)	Description	Pin Name	Pin(s)	Description
PG6	H1	GPIO (5V)	PG7	H2	GPIO (5V)
PG5	H3	GPIO (5V)	PE6	H12	GPIO
PE5	H13	GPIO	DVDD	H14	Digital power supply.
PG9	J1	GPIO (5V)	PG10	J2	GPIO (5V)
PG8	J3	GPIO (5V)	PE3	J12	GPIO
PE4	J13	GPIO	VREGVDD	J14	Voltage regulator VDD input
PG12	K1	GPIO	PG13	K2	GPIO
PG11	K3	GPIO (5V)	PE2	K12	GPIO
PE1	K13	GPIO (5V)	VREGSW	K14	DCDC regulator switching node
PG15	L1	GPIO (5V)	PB15	L2	GPIO (5V)
PG14	L3	GPIO	PC7	L12	GPIO
PE0	L13	GPIO (5V)	VREGVSS	L14	Voltage regulator VSS
PB0	M1	GPIO	PB1	M2	GPIO
PB4	M3	GPIO	PC0	M4	GPIO (5V)
PC3	M5	GPIO (5V)	PA9	M6	GPIO
BODEN	M7	Brown-Out Detector Enable. This pin may be left disconnected or tied to AVDD.	PA12	M8	GPIO (5V)
RESETn	M9	Reset input, active low. To apply an external reset source to this pin, it is required to only drive this pin low during reset, and let the internal pull-up ensure that reset is released.	PB10	M10	GPIO (5V)
PD1	M11	GPIO	PC6	M12	GPIO
PD5	M13	GPIO	PD8	M14	GPIO
PB7	N1	GPIO	PB2	N2	GPIO
PB5	N3	GPIO	PC2	N4	GPIO (5V)
PC5	N5	GPIO	PA8	N6	GPIO
PA11	N7	GPIO	PA14	N8	GPIO
PB11	N9	GPIO	PB12	N10	GPIO
PD0	N11	GPIO (5V)	PD2	N12	GPIO (5V)
PD4	N13	GPIO	PD7	N14	GPIO
PB8	P1	GPIO	PB3	P2	GPIO
PB6	P3	GPIO	PC1	P4	GPIO (5V)
PC4	P5	GPIO	PA7	P6	GPIO
PA10	P7	GPIO	PA13	P8	GPIO (5V)
PB9	P9	GPIO (5V)	PB13	P10	GPIO
PB14	P11	GPIO	AVDD	P12	Analog power supply.
PD3	P13	GPIO	PD6	P14	GPIO

Pin Name	Pin(s)	Description	Pin Name	Pin(s)	Description
<p>Note:</p> <ol style="list-style-type: none"> GPIO with 5V tolerance are indicated by (5V). The pins PD13, PD14, and PD15 will not be 5V tolerant on all future devices. In order to preserve upgrade options with full hardware compatibility, do not use these pins with 5V domains. 					

5.3 EFM32GG11B8xx in BGA120 Device Pinout

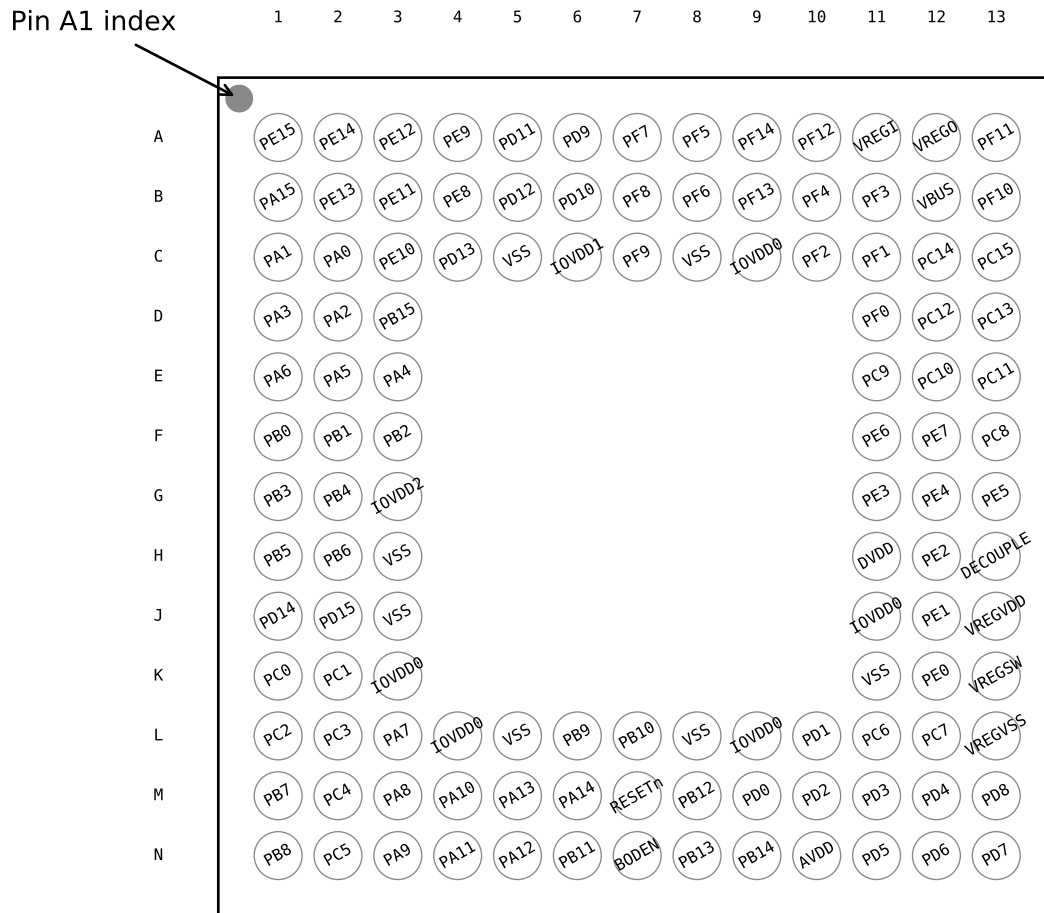

Figure 5.3. EFM32GG11B8xx in BGA120 Device Pinout

The following table provides package pin connections and general descriptions of pin functionality. For detailed information on the supported features for each GPIO pin, see [5.20 GPIO Functionality Table](#) or [5.21 Alternate Functionality Overview](#).

Table 5.3. EFM32GG11B8xx in BGA120 Device Pinout

Pin Name	Pin(s)	Description	Pin Name	Pin(s)	Description
PE15	A1	GPIO	PE14	A2	GPIO
PE12	A3	GPIO	PE9	A4	GPIO
PD11	A5	GPIO	PD9	A6	GPIO
PF7	A7	GPIO	PF5	A8	GPIO
PF14	A9	GPIO (5V)	PF12	A10	GPIO
VREGI	A11	Input to 5 V regulator.	VREGO	A12	Decoupling for 5 V regulator and regulator output. Power for USB PHY in USB-enabled OPNs

Pin Name	Pin(s)	Description	Pin Name	Pin(s)	Description
PF11	A13	GPIO (5V)	PA15	B1	GPIO
PE13	B2	GPIO	PE11	B3	GPIO
PE8	B4	GPIO	PD12	B5	GPIO
PD10	B6	GPIO	PF8	B7	GPIO
PF6	B8	GPIO	PF13	B9	GPIO (5V)
PF4	B10	GPIO	PF3	B11	GPIO
VBUS	B12	USB VBUS signal and auxiliary input to 5 V regulator.	PF10	B13	GPIO (5V)
PA1	C1	GPIO	PA0	C2	GPIO
PE10	C3	GPIO	PD13	C4	GPIO (5V)
VSS	C5 C8 H3 J3 K11 L5 L8	Ground	IOVDD1	C6	Digital IO power supply 1.
PF9	C7	GPIO	IOVDD0	C9 J11 K3 L4 L9	Digital IO power supply 0.
PF2	C10	GPIO	PF1	C11	GPIO (5V)
PC14	C12	GPIO (5V)	PC15	C13	GPIO (5V)
PA3	D1	GPIO	PA2	D2	GPIO
PB15	D3	GPIO (5V)	PF0	D11	GPIO (5V)
PC12	D12	GPIO (5V)	PC13	D13	GPIO (5V)
PA6	E1	GPIO	PA5	E2	GPIO
PA4	E3	GPIO	PC9	E11	GPIO (5V)
PC10	E12	GPIO (5V)	PC11	E13	GPIO (5V)
PB0	F1	GPIO	PB1	F2	GPIO
PB2	F3	GPIO	PE6	F11	GPIO
PE7	F12	GPIO	PC8	F13	GPIO (5V)
PB3	G1	GPIO	PB4	G2	GPIO
IOVDD2	G3	Digital IO power supply 2.	PE3	G11	GPIO
PE4	G12	GPIO	PE5	G13	GPIO
PB5	H1	GPIO	PB6	H2	GPIO
DVDD	H11	Digital power supply.	PE2	H12	GPIO
DECOUPLE	H13	Decouple output for on-chip voltage regulator. An external decoupling capacitor is required at this pin.	PD14	J1	GPIO (5V)
PD15	J2	GPIO (5V)	PE1	J12	GPIO (5V)

Pin Name	Pin(s)	Description	Pin Name	Pin(s)	Description
VREGVDD	J13	Voltage regulator VDD input	PC0	K1	GPIO (5V)
PC1	K2	GPIO (5V)	PE0	K12	GPIO (5V)
VREGSW	K13	DCDC regulator switching node	PC2	L1	GPIO (5V)
PC3	L2	GPIO (5V)	PA7	L3	GPIO
PB9	L6	GPIO (5V)	PB10	L7	GPIO (5V)
PD1	L10	GPIO	PC6	L11	GPIO
PC7	L12	GPIO	VREGVSS	L13	Voltage regulator VSS
PB7	M1	GPIO	PC4	M2	GPIO
PA8	M3	GPIO	PA10	M4	GPIO
PA13	M5	GPIO (5V)	PA14	M6	GPIO
RESETn	M7	Reset input, active low. To apply an external reset source to this pin, it is required to only drive this pin low during reset, and let the internal pull-up ensure that reset is released.	PB12	M8	GPIO
PD0	M9	GPIO (5V)	PD2	M10	GPIO (5V)
PD3	M11	GPIO	PD4	M12	GPIO
PD8	M13	GPIO	PB8	N1	GPIO
PC5	N2	GPIO	PA9	N3	GPIO
PA11	N4	GPIO	PA12	N5	GPIO (5V)
PB11	N6	GPIO	BODEN	N7	Brown-Out Detector Enable. This pin may be left disconnected or tied to AVDD.
PB13	N8	GPIO	PB14	N9	GPIO
AVDD	N10	Analog power supply.	PD5	N11	GPIO
PD6	N12	GPIO	PD7	N13	GPIO

Note:

1. GPIO with 5V tolerance are indicated by (5V).
2. The pins PD13, PD14, and PD15 will not be 5V tolerant on all future devices. In order to preserve upgrade options with full hardware compatibility, do not use these pins with 5V domains.

5.4 EFM32GG11B5xx in BGA120 Device Pinout



Figure 5.4. EFM32GG11B5xx in BGA120 Device Pinout

The following table provides package pin connections and general descriptions of pin functionality. For detailed information on the supported features for each GPIO pin, see [5.20 GPIO Functionality Table](#) or [5.21 Alternate Functionality Overview](#).

Table 5.4. EFM32GG11B5xx in BGA120 Device Pinout

Pin Name	Pin(s)	Description	Pin Name	Pin(s)	Description
PE15	A1	GPIO	PE14	A2	GPIO
PE12	A3	GPIO	PE9	A4	GPIO
PD11	A5	GPIO	PD9	A6	GPIO
PF7	A7	GPIO	PF5	A8	GPIO
PF14	A9	GPIO (5V)	PF12	A10	GPIO
VREGI	A11	Input to 5 V regulator.	VREGO	A12	Decoupling for 5 V regulator and regulator output. Power for USB PHY in USB-enabled OPNs

Pin Name	Pin(s)	Description	Pin Name	Pin(s)	Description
PF11	A13	GPIO (5V)	PA15	B1	GPIO
PE13	B2	GPIO	PE11	B3	GPIO
PE8	B4	GPIO	PD12	B5	GPIO
PD10	B6	GPIO	PF8	B7	GPIO
PF6	B8	GPIO	PF13	B9	GPIO (5V)
PF4	B10	GPIO	PF3	B11	GPIO
NC	B12	No Connect.	PF10	B13	GPIO (5V)
PA1	C1	GPIO	PA0	C2	GPIO
PE10	C3	GPIO	PD13	C4	GPIO (5V)
VSS	C5 C8 H3 J3 K11 L5 L8	Ground	IOVDD1	C6	Digital IO power supply 1.
PF9	C7	GPIO	IOVDD0	C9 J11 K3 L4 L9	Digital IO power supply 0.
PF2	C10	GPIO	PF1	C11	GPIO (5V)
PC14	C12	GPIO (5V)	PC15	C13	GPIO (5V)
PA3	D1	GPIO	PA2	D2	GPIO
PB15	D3	GPIO (5V)	PF0	D11	GPIO (5V)
PC12	D12	GPIO (5V)	PC13	D13	GPIO (5V)
PA6	E1	GPIO	PA5	E2	GPIO
PA4	E3	GPIO	PC9	E11	GPIO (5V)
PC10	E12	GPIO (5V)	PC11	E13	GPIO (5V)
PB0	F1	GPIO	PB1	F2	GPIO
PB2	F3	GPIO	PE6	F11	GPIO
PE7	F12	GPIO	PC8	F13	GPIO (5V)
PB3	G1	GPIO	PB4	G2	GPIO
IOVDD2	G3	Digital IO power supply 2.	PE3	G11	GPIO
PE4	G12	GPIO	PE5	G13	GPIO
PB5	H1	GPIO	PB6	H2	GPIO
DVDD	H11	Digital power supply.	PE2	H12	GPIO
DECOUPLE	H13	Decouple output for on-chip voltage regulator. An external decoupling capacitor is required at this pin.	PD14	J1	GPIO (5V)
PD15	J2	GPIO (5V)	PE1	J12	GPIO (5V)
VREGVDD	J13	Voltage regulator VDD input	PC0	K1	GPIO (5V)

Pin Name	Pin(s)	Description	Pin Name	Pin(s)	Description
PC1	K2	GPIO (5V)	PE0	K12	GPIO (5V)
VREGSW	K13	DCDC regulator switching node	PC2	L1	GPIO (5V)
PC3	L2	GPIO (5V)	PA7	L3	GPIO
PB9	L6	GPIO (5V)	PB10	L7	GPIO (5V)
PD1	L10	GPIO	PC6	L11	GPIO
PC7	L12	GPIO	VREGVSS	L13	Voltage regulator VSS
PB7	M1	GPIO	PC4	M2	GPIO
PA8	M3	GPIO	PA10	M4	GPIO
PA13	M5	GPIO (5V)	PA14	M6	GPIO
RESETn	M7	Reset input, active low. To apply an external reset source to this pin, it is required to only drive this pin low during reset, and let the internal pull-up ensure that reset is released.	PB12	M8	GPIO
PD0	M9	GPIO (5V)	PD2	M10	GPIO (5V)
PD3	M11	GPIO	PD4	M12	GPIO
PD8	M13	GPIO	PB8	N1	GPIO
PC5	N2	GPIO	PA9	N3	GPIO
PA11	N4	GPIO	PA12	N5	GPIO (5V)
PB11	N6	GPIO	BODEN	N7	Brown-Out Detector Enable. This pin may be left disconnected or tied to AVDD.
PB13	N8	GPIO	PB14	N9	GPIO
AVDD	N10	Analog power supply.	PD5	N11	GPIO
PD6	N12	GPIO	PD7	N13	GPIO

Note:

1. GPIO with 5V tolerance are indicated by (5V).
2. The pins PD13, PD14, and PD15 will not be 5V tolerant on all future devices. In order to preserve upgrade options with full hardware compatibility, do not use these pins with 5V domains.

5.5 EFM32GG11B4xx in BGA120 Device Pinout

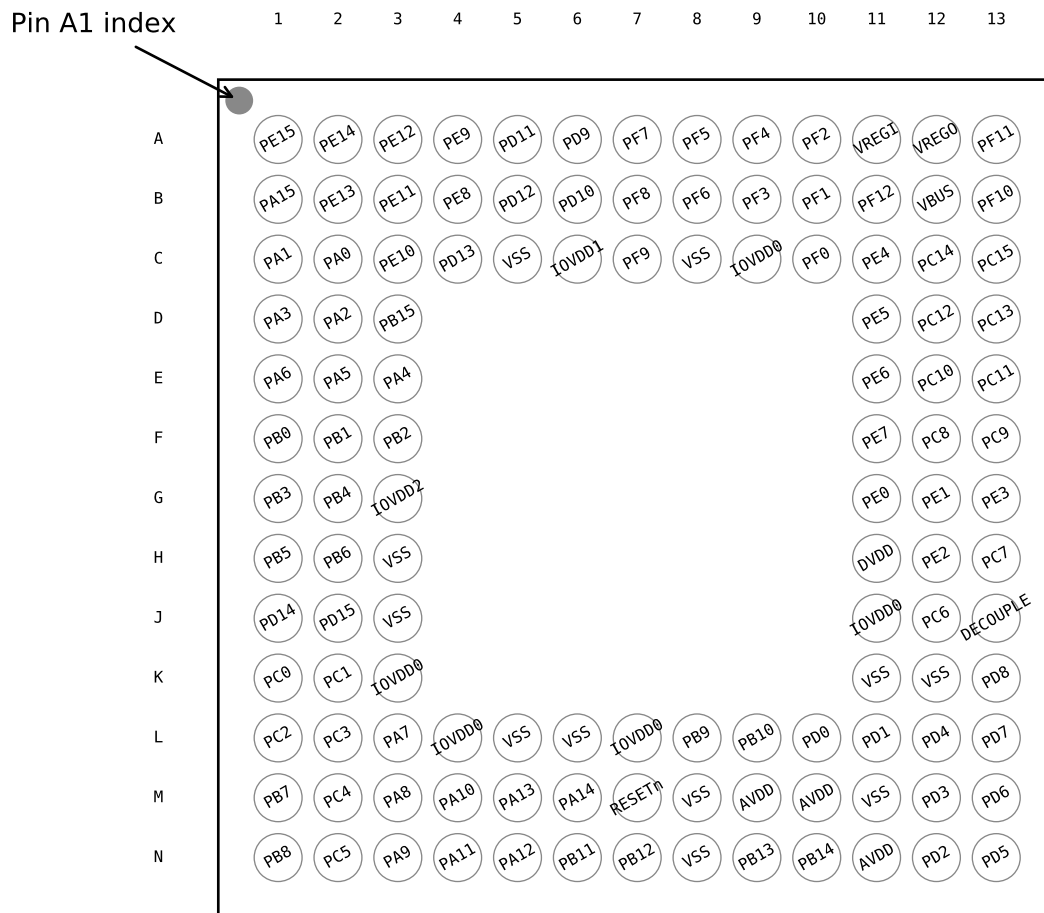

Figure 5.5. EFM32GG11B4xx in BGA120 Device Pinout

The following table provides package pin connections and general descriptions of pin functionality. For detailed information on the supported features for each GPIO pin, see [5.20 GPIO Functionality Table](#) or [5.21 Alternate Functionality Overview](#).

Table 5.5. EFM32GG11B4xx in BGA120 Device Pinout

Pin Name	Pin(s)	Description	Pin Name	Pin(s)	Description
PE15	A1	GPIO	PE14	A2	GPIO
PE12	A3	GPIO	PE9	A4	GPIO
PD11	A5	GPIO	PD9	A6	GPIO
PF7	A7	GPIO	PF5	A8	GPIO
PF4	A9	GPIO	PF2	A10	GPIO
VREGI	A11	Input to 5 V regulator.	VREGO	A12	Decoupling for 5 V regulator and regulator output. Power for USB PHY in USB-enabled OPNs

Pin Name	Pin(s)	Description	Pin Name	Pin(s)	Description
PF11	A13	GPIO (5V)	PA15	B1	GPIO
PE13	B2	GPIO	PE11	B3	GPIO
PE8	B4	GPIO	PD12	B5	GPIO
PD10	B6	GPIO	PF8	B7	GPIO
PF6	B8	GPIO	PF3	B9	GPIO
PF1	B10	GPIO (5V)	PF12	B11	GPIO
VBUS	B12	USB VBUS signal and auxiliary input to 5 V regulator.	PF10	B13	GPIO (5V)
PA1	C1	GPIO	PA0	C2	GPIO
PE10	C3	GPIO	PD13	C4	GPIO (5V)
VSS	C5 C8 H3 J3 K11 K12 L5 L6 M8 M11 N8	Ground	IOVDD1	C6	Digital IO power supply 1.
PF9	C7	GPIO	IOVDD0	C9 J11 K3 L4 L7	Digital IO power supply 0.
PF0	C10	GPIO (5V)	PE4	C11	GPIO
PC14	C12	GPIO (5V)	PC15	C13	GPIO (5V)
PA3	D1	GPIO	PA2	D2	GPIO
PB15	D3	GPIO (5V)	PE5	D11	GPIO
PC12	D12	GPIO (5V)	PC13	D13	GPIO (5V)
PA6	E1	GPIO	PA5	E2	GPIO
PA4	E3	GPIO	PE6	E11	GPIO
PC10	E12	GPIO (5V)	PC11	E13	GPIO (5V)
PB0	F1	GPIO	PB1	F2	GPIO
PB2	F3	GPIO	PE7	F11	GPIO
PC8	F12	GPIO (5V)	PC9	F13	GPIO (5V)
PB3	G1	GPIO	PB4	G2	GPIO
IOVDD2	G3	Digital IO power supply 2.	PE0	G11	GPIO (5V)
PE1	G12	GPIO (5V)	PE3	G13	GPIO
PB5	H1	GPIO	PB6	H2	GPIO
DVDD	H11	Digital power supply.	PE2	H12	GPIO
PC7	H13	GPIO	PD14	J1	GPIO (5V)

Pin Name	Pin(s)	Description	Pin Name	Pin(s)	Description
PD15	J2	GPIO (5V)	PC6	J12	GPIO
DECOUPLE	J13	Decouple output for on-chip voltage regulator. An external decoupling capacitor is required at this pin.	PC0	K1	GPIO (5V)
PC1	K2	GPIO (5V)	PD8	K13	GPIO
PC2	L1	GPIO (5V)	PC3	L2	GPIO (5V)
PA7	L3	GPIO	PB9	L8	GPIO (5V)
PB10	L9	GPIO (5V)	PD0	L10	GPIO (5V)
PD1	L11	GPIO	PD4	L12	GPIO
PD7	L13	GPIO	PB7	M1	GPIO
PC4	M2	GPIO	PA8	M3	GPIO
PA10	M4	GPIO	PA13	M5	GPIO (5V)
PA14	M6	GPIO	RESETn	M7	Reset input, active low. To apply an external reset source to this pin, it is required to only drive this pin low during reset, and let the internal pull-up ensure that reset is released.
AVDD	M9 M10 N11	Analog power supply.	PD3	M12	GPIO
PD6	M13	GPIO	PB8	N1	GPIO
PC5	N2	GPIO	PA9	N3	GPIO
PA11	N4	GPIO	PA12	N5	GPIO (5V)
PB11	N6	GPIO	PB12	N7	GPIO
PB13	N9	GPIO	PB14	N10	GPIO
PD2	N12	GPIO (5V)	PD5	N13	GPIO

Note:

1. GPIO with 5V tolerance are indicated by (5V).
2. The pins PD13, PD14, and PD15 will not be 5V tolerant on all future devices. In order to preserve upgrade options with full hardware compatibility, do not use these pins with 5V domains.

5.6 EFM32GG11B4xx in BGA112 Device Pinout



Figure 5.6. EFM32GG11B4xx in BGA112 Device Pinout

The following table provides package pin connections and general descriptions of pin functionality. For detailed information on the supported features for each GPIO pin, see [5.20 GPIO Functionality Table](#) or [5.21 Alternate Functionality Overview](#).

Table 5.6. EFM32GG11B4xx in BGA112 Device Pinout

Pin Name	Pin(s)	Description	Pin Name	Pin(s)	Description
PE15	A1	GPIO	PE14	A2	GPIO
PE12	A3	GPIO	PE9	A4	GPIO
PD10	A5	GPIO	PF7	A6	GPIO
PF5	A7	GPIO	PF12	A8	GPIO
PE4	A9	GPIO	PF10	A10	GPIO (5V)
PF11	A11	GPIO (5V)	PA15	B1	GPIO
PE13	B2	GPIO	PE11	B3	GPIO

Pin Name	Pin(s)	Description	Pin Name	Pin(s)	Description
PE8	B4	GPIO	PD11	B5	GPIO
PF8	B6	GPIO	PF6	B7	GPIO
VBUS	B8	USB VBUS signal and auxiliary input to 5 V regulator.	PE5	B9	GPIO
VREGI	B10	Input to 5 V regulator.	VREGO	B11	Decoupling for 5 V regulator and regulator output. Power for USB PHY in USB-enabled OPNs
PA1	C1	GPIO	PA0	C2	GPIO
PE10	C3	GPIO	PD13	C4	GPIO (5V)
PD12	C5	GPIO	PF9	C6	GPIO
VSS	C7 D4 F9 G3 G9 H6 K4 K7 K10 L7	Ground	PF2	C8	GPIO
PE6	C9	GPIO	PC10	C10	GPIO (5V)
PC11	C11	GPIO (5V)	PA3	D1	GPIO
PA2	D2	GPIO	PB15	D3	GPIO (5V)
IOVDD1	D5	Digital IO power supply 1.	PD9	D6	GPIO
IOVDD0	D7 G8 H7 L4	Digital IO power supply 0.	PF1	D8	GPIO (5V)
PE7	D9	GPIO	PC8	D10	GPIO (5V)
PC9	D11	GPIO (5V)	PA6	E1	GPIO
PA5	E2	GPIO	PA4	E3	GPIO
PB0	E4	GPIO	PF0	E8	GPIO (5V)
PE0	E9	GPIO (5V)	PE1	E10	GPIO (5V)
PE3	E11	GPIO	PB1	F1	GPIO
PB2	F2	GPIO	PB3	F3	GPIO
PB4	F4	GPIO	DVDD	F8	Digital power supply.
PE2	F10	GPIO	DECOUPLE	F11	Decouple output for on-chip voltage regulator. An external decoupling capacitor is required at this pin.
PB5	G1	GPIO	PB6	G2	GPIO
IOVDD2	G4	Digital IO power supply 2.	PC6	G10	GPIO
PC7	G11	GPIO	PC0	H1	GPIO (5V)
PC2	H2	GPIO (5V)	PD14	H3	GPIO (5V)
PA7	H4	GPIO	PA8	H5	GPIO

Pin Name	Pin(s)	Description	Pin Name	Pin(s)	Description
PD8	H8	GPIO	PD5	H9	GPIO
PD6	H10	GPIO	PD7	H11	GPIO
PC1	J1	GPIO (5V)	PC3	J2	GPIO (5V)
PD15	J3	GPIO (5V)	PA12	J4	GPIO (5V)
PA9	J5	GPIO	PA10	J6	GPIO
PB9	J7	GPIO (5V)	PB10	J8	GPIO (5V)
PD2	J9	GPIO (5V)	PD3	J10	GPIO
PD4	J11	GPIO	PB7	K1	GPIO
PC4	K2	GPIO	PA13	K3	GPIO (5V)
PA11	K5	GPIO	RESETn	K6	Reset input, active low. To apply an external reset source to this pin, it is required to only drive this pin low during reset, and let the internal pull-up ensure that reset is released.
AVDD	K8 K9 L10	Analog power supply.	PD1	K11	GPIO
PB8	L1	GPIO	PC5	L2	GPIO
PA14	L3	GPIO	PB11	L5	GPIO
PB12	L6	GPIO	PB13	L8	GPIO
PB14	L9	GPIO	PD0	L11	GPIO (5V)

Note:

1. GPIO with 5V tolerance are indicated by (5V).
2. The pins PD13, PD14, and PD15 will not be 5V tolerant on all future devices. In order to preserve upgrade options with full hardware compatibility, do not use these pins with 5V domains.

5.7 EFM32GG11B3xx in BGA112 Device Pinout



Figure 5.7. EFM32GG11B3xx in BGA112 Device Pinout

The following table provides package pin connections and general descriptions of pin functionality. For detailed information on the supported features for each GPIO pin, see [5.20 GPIO Functionality Table](#) or [5.21 Alternate Functionality Overview](#).

Table 5.7. EFM32GG11B3xx in BGA112 Device Pinout

Pin Name	Pin(s)	Description	Pin Name	Pin(s)	Description
PE15	A1	GPIO	PE14	A2	GPIO
PE12	A3	GPIO	PE9	A4	GPIO
PD10	A5	GPIO	PF7	A6	GPIO
PF5	A7	GPIO	PF4	A8	GPIO
PE4	A9	GPIO	PC14	A10	GPIO (5V)
PC15	A11	GPIO (5V)	PA15	B1	GPIO
PE13	B2	GPIO	PE11	B3	GPIO

Pin Name	Pin(s)	Description	Pin Name	Pin(s)	Description
PE8	B4	GPIO	PD11	B5	GPIO
PF8	B6	GPIO	PF6	B7	GPIO
PF3	B8	GPIO	PE5	B9	GPIO
PC12	B10	GPIO (5V)	PC13	B11	GPIO (5V)
PA1	C1	GPIO	PA0	C2	GPIO
PE10	C3	GPIO	PD13	C4	GPIO (5V)
PD12	C5	GPIO	PF9	C6	GPIO
VSS	C7 D4 F9 G3 G9 H6 K4 K7 K10 L7	Ground	PF2	C8	GPIO
PE6	C9	GPIO	PC10	C10	GPIO (5V)
PC11	C11	GPIO (5V)	PA3	D1	GPIO
PA2	D2	GPIO	PB15	D3	GPIO (5V)
IOVDD1	D5	Digital IO power supply 1.	PD9	D6	GPIO
IOVDD0	D7 G8 H7 L4	Digital IO power supply 0.	PF1	D8	GPIO (5V)
PE7	D9	GPIO	PC8	D10	GPIO (5V)
PC9	D11	GPIO (5V)	PA6	E1	GPIO
PA5	E2	GPIO	PA4	E3	GPIO
PB0	E4	GPIO	PF0	E8	GPIO (5V)
PE0	E9	GPIO (5V)	PE1	E10	GPIO (5V)
PE3	E11	GPIO	PB1	F1	GPIO
PB2	F2	GPIO	PB3	F3	GPIO
PB4	F4	GPIO	DVDD	F8	Digital power supply.
PE2	F10	GPIO	DECOUPLE	F11	Decouple output for on-chip voltage regulator. An external decoupling capacitor is required at this pin.
PB5	G1	GPIO	PB6	G2	GPIO
IOVDD2	G4	Digital IO power supply 2.	PC6	G10	GPIO
PC7	G11	GPIO	PC0	H1	GPIO (5V)
PC2	H2	GPIO (5V)	PD14	H3	GPIO (5V)
PA7	H4	GPIO	PA8	H5	GPIO
PD8	H8	GPIO	PD5	H9	GPIO
PD6	H10	GPIO	PD7	H11	GPIO

Pin Name	Pin(s)	Description	Pin Name	Pin(s)	Description
PC1	J1	GPIO (5V)	PC3	J2	GPIO (5V)
PD15	J3	GPIO (5V)	PA12	J4	GPIO (5V)
PA9	J5	GPIO	PA10	J6	GPIO
PB9	J7	GPIO (5V)	PB10	J8	GPIO (5V)
PD2	J9	GPIO (5V)	PD3	J10	GPIO
PD4	J11	GPIO	PB7	K1	GPIO
PC4	K2	GPIO	PA13	K3	GPIO (5V)
PA11	K5	GPIO	RESETn	K6	Reset input, active low. To apply an external reset source to this pin, it is required to only drive this pin low during reset, and let the internal pull-up ensure that reset is released.
AVDD	K8 K9 L10	Analog power supply.	PD1	K11	GPIO
PB8	L1	GPIO	PC5	L2	GPIO
PA14	L3	GPIO	PB11	L5	GPIO
PB12	L6	GPIO	PB13	L8	GPIO
PB14	L9	GPIO	PD0	L11	GPIO (5V)

Note:

1. GPIO with 5V tolerance are indicated by (5V).
2. The pins PD13, PD14, and PD15 will not be 5V tolerant on all future devices. In order to preserve upgrade options with full hardware compatibility, do not use these pins with 5V domains.

5.8 EFM32GG11B8xx in QFP100 Device Pinout

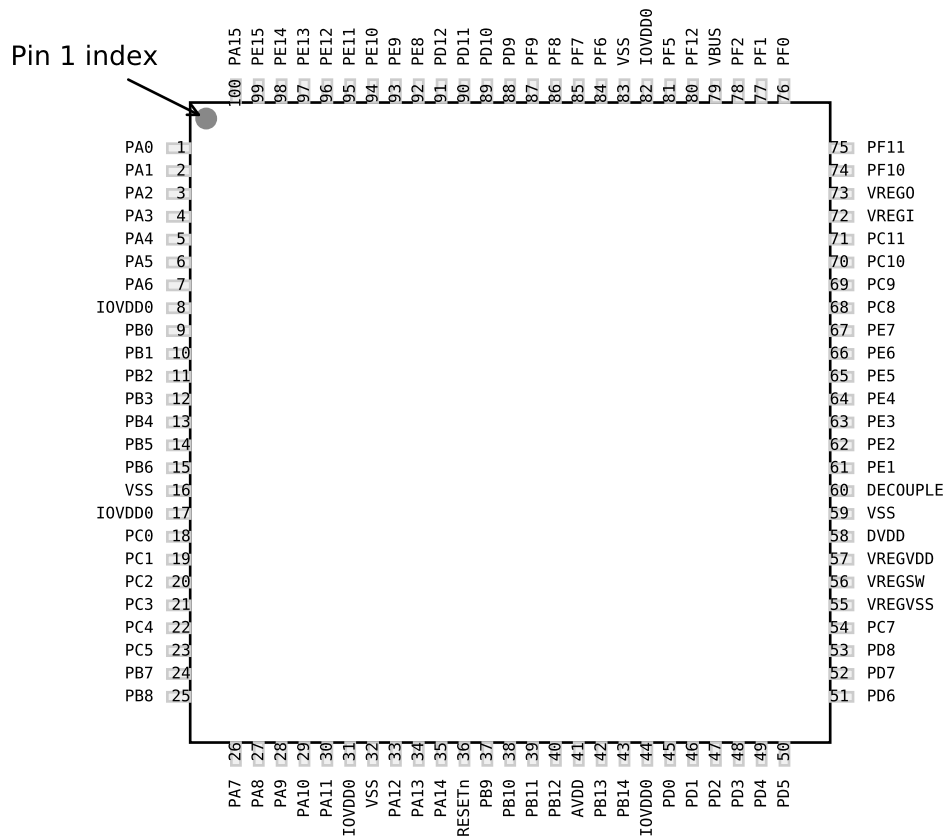

Figure 5.8. EFM32GG11B8xx in QFP100 Device Pinout

The following table provides package pin connections and general descriptions of pin functionality. For detailed information on the supported features for each GPIO pin, see [5.20 GPIO Functionality Table](#) or [5.21 Alternate Functionality Overview](#).

Table 5.8. EFM32GG11B8xx in QFP100 Device Pinout

Pin Name	Pin(s)	Description	Pin Name	Pin(s)	Description
PA0	1	GPIO	PA1	2	GPIO
PA2	3	GPIO	PA3	4	GPIO
PA4	5	GPIO	PA5	6	GPIO
PA6	7	GPIO	IOVDD0	8, 17, 31, 44, 82	Digital IO power supply 0.
PB0	9	GPIO	PB1	10	GPIO

Pin Name	Pin(s)	Description	Pin Name	Pin(s)	Description
PB2	11	GPIO	PB3	12	GPIO
PB4	13	GPIO	PB5	14	GPIO
PB6	15	GPIO	VSS	16 32 59 83	Ground
PC0	18	GPIO (5V)	PC1	19	GPIO (5V)
PC2	20	GPIO (5V)	PC3	21	GPIO (5V)
PC4	22	GPIO	PC5	23	GPIO
PB7	24	GPIO	PB8	25	GPIO
PA7	26	GPIO	PA8	27	GPIO
PA9	28	GPIO	PA10	29	GPIO
PA11	30	GPIO	PA12	33	GPIO (5V)
PA13	34	GPIO (5V)	PA14	35	GPIO
RESETn	36	Reset input, active low. To apply an external reset source to this pin, it is required to only drive this pin low during reset, and let the internal pull-up ensure that reset is released.	PB9	37	GPIO (5V)
PB10	38	GPIO (5V)	PB11	39	GPIO
PB12	40	GPIO	AVDD	41	Analog power supply.
PB13	42	GPIO	PB14	43	GPIO
PD0	45	GPIO (5V)	PD1	46	GPIO
PD2	47	GPIO (5V)	PD3	48	GPIO
PD4	49	GPIO	PD5	50	GPIO
PD6	51	GPIO	PD7	52	GPIO
PD8	53	GPIO	PC7	54	GPIO
VREGVSS	55	Voltage regulator VSS	VREGSW	56	DCDC regulator switching node
VREGVDD	57	Voltage regulator VDD input	DVDD	58	Digital power supply.
DECOUPLE	60	Decouple output for on-chip voltage regulator. An external decoupling capacitor is required at this pin.	PE1	61	GPIO (5V)
PE2	62	GPIO	PE3	63	GPIO
PE4	64	GPIO	PE5	65	GPIO
PE6	66	GPIO	PE7	67	GPIO
PC8	68	GPIO (5V)	PC9	69	GPIO (5V)
PC10	70	GPIO (5V)	PC11	71	GPIO (5V)
VREGI	72	Input to 5 V regulator.	VREGO	73	Decoupling for 5 V regulator and regulator output. Power for USB PHY in USB-enabled OPNs
PF10	74	GPIO (5V)	PF11	75	GPIO (5V)
PF0	76	GPIO (5V)	PF1	77	GPIO (5V)

Pin Name	Pin(s)	Description	Pin Name	Pin(s)	Description
PF2	78	GPIO	VBUS	79	USB VBUS signal and auxiliary input to 5 V regulator.
PF12	80	GPIO	PF5	81	GPIO
PF6	84	GPIO	PF7	85	GPIO
PF8	86	GPIO	PF9	87	GPIO
PD9	88	GPIO	PD10	89	GPIO
PD11	90	GPIO	PD12	91	GPIO
PE8	92	GPIO	PE9	93	GPIO
PE10	94	GPIO	PE11	95	GPIO
PE12	96	GPIO	PE13	97	GPIO
PE14	98	GPIO	PE15	99	GPIO
PA15	100	GPIO			

Note:

1. GPIO with 5V tolerance are indicated by (5V).

5.9 EFM32GG11B5xx in QFP100 Device Pinout

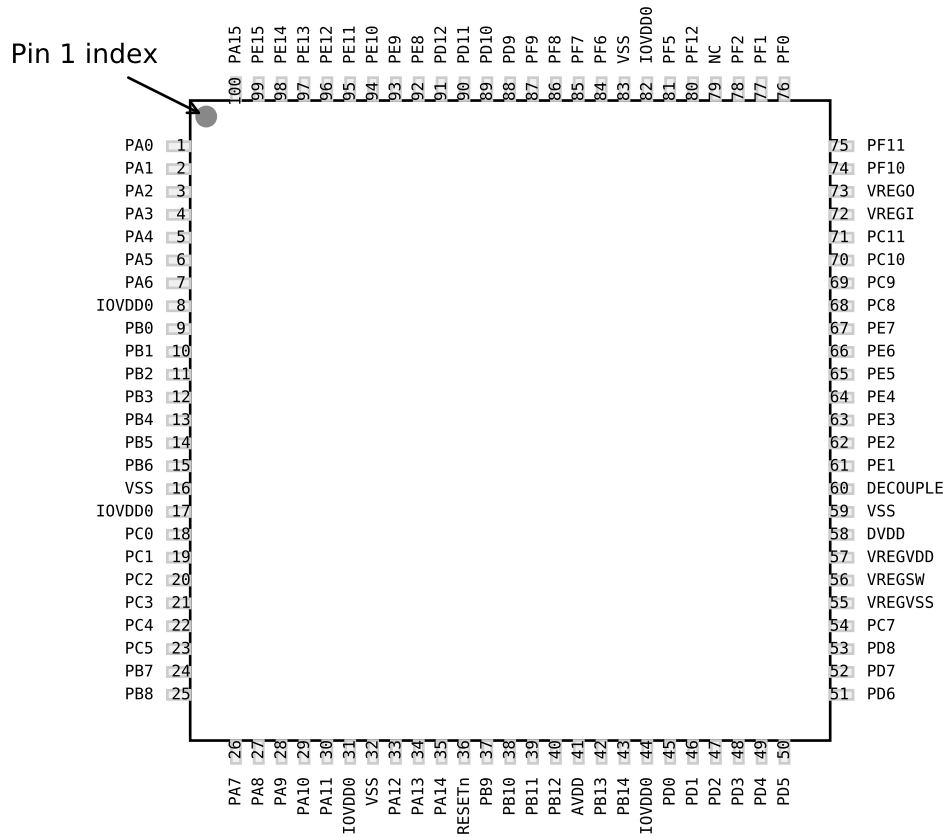

Figure 5.9. EFM32GG11B5xx in QFP100 Device Pinout

The following table provides package pin connections and general descriptions of pin functionality. For detailed information on the supported features for each GPIO pin, see [5.20 GPIO Functionality Table](#) or [5.21 Alternate Functionality Overview](#).

Table 5.9. EFM32GG11B5xx in QFP100 Device Pinout

Pin Name	Pin(s)	Description	Pin Name	Pin(s)	Description
PA0	1	GPIO	PA1	2	GPIO
PA2	3	GPIO	PA3	4	GPIO
PA4	5	GPIO	PA5	6	GPIO
PA6	7	GPIO	IOVDD0	8, 17, 31, 44, 82	Digital IO power supply 0.
PB0	9	GPIO	PB1	10	GPIO

Pin Name	Pin(s)	Description	Pin Name	Pin(s)	Description
PB2	11	GPIO	PB3	12	GPIO
PB4	13	GPIO	PB5	14	GPIO
PB6	15	GPIO	VSS	16 32 59 83	Ground
PC0	18	GPIO (5V)	PC1	19	GPIO (5V)
PC2	20	GPIO (5V)	PC3	21	GPIO (5V)
PC4	22	GPIO	PC5	23	GPIO
PB7	24	GPIO	PB8	25	GPIO
PA7	26	GPIO	PA8	27	GPIO
PA9	28	GPIO	PA10	29	GPIO
PA11	30	GPIO	PA12	33	GPIO (5V)
PA13	34	GPIO (5V)	PA14	35	GPIO
RESETn	36	Reset input, active low. To apply an external reset source to this pin, it is required to only drive this pin low during reset, and let the internal pull-up ensure that reset is released.	PB9	37	GPIO (5V)
PB10	38	GPIO (5V)	PB11	39	GPIO
PB12	40	GPIO	AVDD	41	Analog power supply.
PB13	42	GPIO	PB14	43	GPIO
PD0	45	GPIO (5V)	PD1	46	GPIO
PD2	47	GPIO (5V)	PD3	48	GPIO
PD4	49	GPIO	PD5	50	GPIO
PD6	51	GPIO	PD7	52	GPIO
PD8	53	GPIO	PC7	54	GPIO
VREGVSS	55	Voltage regulator VSS	VREGSW	56	DCDC regulator switching node
VREGVDD	57	Voltage regulator VDD input	DVDD	58	Digital power supply.
DECOUPLE	60	Decouple output for on-chip voltage regulator. An external decoupling capacitor is required at this pin.	PE1	61	GPIO (5V)
PE2	62	GPIO	PE3	63	GPIO
PE4	64	GPIO	PE5	65	GPIO
PE6	66	GPIO	PE7	67	GPIO
PC8	68	GPIO (5V)	PC9	69	GPIO (5V)
PC10	70	GPIO (5V)	PC11	71	GPIO (5V)
VREGI	72	Input to 5 V regulator.	VREGO	73	Decoupling for 5 V regulator and regulator output. Power for USB PHY in USB-enabled OPNs
PF10	74	GPIO (5V)	PF11	75	GPIO (5V)
PF0	76	GPIO (5V)	PF1	77	GPIO (5V)

Pin Name	Pin(s)	Description	Pin Name	Pin(s)	Description
PF2	78	GPIO	NC	79	No Connect.
PF12	80	GPIO	PF5	81	GPIO
PF6	84	GPIO	PF7	85	GPIO
PF8	86	GPIO	PF9	87	GPIO
PD9	88	GPIO	PD10	89	GPIO
PD11	90	GPIO	PD12	91	GPIO
PE8	92	GPIO	PE9	93	GPIO
PE10	94	GPIO	PE11	95	GPIO
PE12	96	GPIO	PE13	97	GPIO
PE14	98	GPIO	PE15	99	GPIO
PA15	100	GPIO			

Note:

1. GPIO with 5V tolerance are indicated by (5V).

5.10 EFM32GG11B4xx in QFP100 Device Pinout



Figure 5.10. EFM32GG11B4xx in QFP100 Device Pinout

The following table provides package pin connections and general descriptions of pin functionality. For detailed information on the supported features for each GPIO pin, see [5.20 GPIO Functionality Table](#) or [5.21 Alternate Functionality Overview](#).

Table 5.10. EFM32GG11B4xx in QFP100 Device Pinout

Pin Name	Pin(s)	Description	Pin Name	Pin(s)	Description
PA0	1	GPIO	PA1	2	GPIO
PA2	3	GPIO	PA3	4	GPIO
PA4	5	GPIO	PA5	6	GPIO
PA6	7	GPIO	IOVDD0	8, 17, 31, 44, 82	Digital IO power supply 0.
PB0	9	GPIO	PB1	10	GPIO

Pin Name	Pin(s)	Description	Pin Name	Pin(s)	Description
PB2	11	GPIO	PB3	12	GPIO
PB4	13	GPIO	PB5	14	GPIO
PB6	15	GPIO	VSS	16 32 58 83	Ground
PC0	18	GPIO (5V)	PC1	19	GPIO (5V)
PC2	20	GPIO (5V)	PC3	21	GPIO (5V)
PC4	22	GPIO	PC5	23	GPIO
PB7	24	GPIO	PB8	25	GPIO
PA7	26	GPIO	PA8	27	GPIO
PA9	28	GPIO	PA10	29	GPIO
PA11	30	GPIO	PA12	33	GPIO (5V)
PA13	34	GPIO (5V)	PA14	35	GPIO
RESETn	36	Reset input, active low. To apply an external reset source to this pin, it is required to only drive this pin low during reset, and let the internal pull-up ensure that reset is released.	PB9	37	GPIO (5V)
PB10	38	GPIO (5V)	PB11	39	GPIO
PB12	40	GPIO	AVDD	41 45	Analog power supply.
PB13	42	GPIO	PB14	43	GPIO
PD0	46	GPIO (5V)	PD1	47	GPIO
PD2	48	GPIO (5V)	PD3	49	GPIO
PD4	50	GPIO	PD5	51	GPIO
PD6	52	GPIO	PD7	53	GPIO
PD8	54	GPIO	PC6	55	GPIO
PC7	56	GPIO	DVDD	57	Digital power supply.
DECOUPLE	59	Decouple output for on-chip voltage regulator. An external decoupling capacitor is required at this pin.	PE0	60	GPIO (5V)
PE1	61	GPIO (5V)	PE2	62	GPIO
PE3	63	GPIO	PE4	64	GPIO
PE5	65	GPIO	PE6	66	GPIO
PE7	67	GPIO	PC8	68	GPIO (5V)
PC9	69	GPIO (5V)	PC10	70	GPIO (5V)
PC11	71	GPIO (5V)	VREGI	72	Input to 5 V regulator.
VREGO	73	Decoupling for 5 V regulator and regulator output. Power for USB PHY in USB-enabled OPNs	PF10	74	GPIO (5V)
PF11	75	GPIO (5V)	PF0	76	GPIO (5V)

Pin Name	Pin(s)	Description	Pin Name	Pin(s)	Description
PF1	77	GPIO (5V)	PF2	78	GPIO
VBUS	79	USB VBUS signal and auxiliary input to 5 V regulator.	PF12	80	GPIO
PF5	81	GPIO	PF6	84	GPIO
PF7	85	GPIO	PF8	86	GPIO
PF9	87	GPIO	PD9	88	GPIO
PD10	89	GPIO	PD11	90	GPIO
PD12	91	GPIO	PE8	92	GPIO
PE9	93	GPIO	PE10	94	GPIO
PE11	95	GPIO	PE12	96	GPIO
PE13	97	GPIO	PE14	98	GPIO
PE15	99	GPIO	PA15	100	GPIO

Note:

1. GPIO with 5V tolerance are indicated by (5V).

5.11 EFM32GG11B3xx in QFP100 Device Pinout

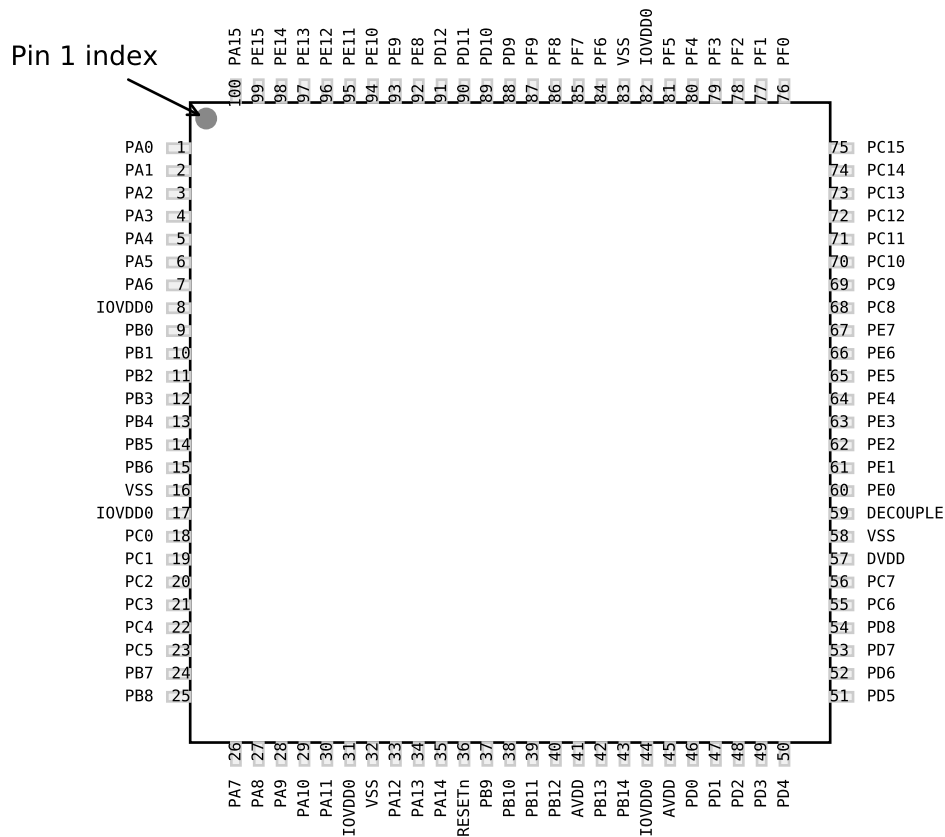

Figure 5.11. EFM32GG11B3xx in QFP100 Device Pinout

The following table provides package pin connections and general descriptions of pin functionality. For detailed information on the supported features for each GPIO pin, see [5.20 GPIO Functionality Table](#) or [5.21 Alternate Functionality Overview](#).

Table 5.11. EFM32GG11B3xx in QFP100 Device Pinout

Pin Name	Pin(s)	Description	Pin Name	Pin(s)	Description
PA0	1	GPIO	PA1	2	GPIO
PA2	3	GPIO	PA3	4	GPIO
PA4	5	GPIO	PA5	6	GPIO
PA6	7	GPIO	IOVDD0	8, 17, 31, 44, 82	Digital IO power supply 0.
PB0	9	GPIO	PB1	10	GPIO

Pin Name	Pin(s)	Description	Pin Name	Pin(s)	Description
PB2	11	GPIO	PB3	12	GPIO
PB4	13	GPIO	PB5	14	GPIO
PB6	15	GPIO	VSS	16 32 58 83	Ground
PC0	18	GPIO (5V)	PC1	19	GPIO (5V)
PC2	20	GPIO (5V)	PC3	21	GPIO (5V)
PC4	22	GPIO	PC5	23	GPIO
PB7	24	GPIO	PB8	25	GPIO
PA7	26	GPIO	PA8	27	GPIO
PA9	28	GPIO	PA10	29	GPIO
PA11	30	GPIO	PA12	33	GPIO (5V)
PA13	34	GPIO (5V)	PA14	35	GPIO
RESETn	36	Reset input, active low. To apply an external reset source to this pin, it is required to only drive this pin low during reset, and let the internal pull-up ensure that reset is released.	PB9	37	GPIO (5V)
PB10	38	GPIO (5V)	PB11	39	GPIO
PB12	40	GPIO	AVDD	41 45	Analog power supply.
PB13	42	GPIO	PB14	43	GPIO
PD0	46	GPIO (5V)	PD1	47	GPIO
PD2	48	GPIO (5V)	PD3	49	GPIO
PD4	50	GPIO	PD5	51	GPIO
PD6	52	GPIO	PD7	53	GPIO
PD8	54	GPIO	PC6	55	GPIO
PC7	56	GPIO	DVDD	57	Digital power supply.
DECOUPLE	59	Decouple output for on-chip voltage regulator. An external decoupling capacitor is required at this pin.	PE0	60	GPIO (5V)
PE1	61	GPIO (5V)	PE2	62	GPIO
PE3	63	GPIO	PE4	64	GPIO
PE5	65	GPIO	PE6	66	GPIO
PE7	67	GPIO	PC8	68	GPIO (5V)
PC9	69	GPIO (5V)	PC10	70	GPIO (5V)
PC11	71	GPIO (5V)	PC12	72	GPIO (5V)
PC13	73	GPIO (5V)	PC14	74	GPIO (5V)
PC15	75	GPIO (5V)	PF0	76	GPIO (5V)
PF1	77	GPIO (5V)	PF2	78	GPIO

Pin Name	Pin(s)	Description	Pin Name	Pin(s)	Description
PF3	79	GPIO	PF4	80	GPIO
PF5	81	GPIO	PF6	84	GPIO
PF7	85	GPIO	PF8	86	GPIO
PF9	87	GPIO	PD9	88	GPIO
PD10	89	GPIO	PD11	90	GPIO
PD12	91	GPIO	PE8	92	GPIO
PE9	93	GPIO	PE10	94	GPIO
PE11	95	GPIO	PE12	96	GPIO
PE13	97	GPIO	PE14	98	GPIO
PE15	99	GPIO	PA15	100	GPIO

Note:

1. GPIO with 5V tolerance are indicated by (5V).

5.12 EFM32GG11B8xx in QFP64 Device Pinout

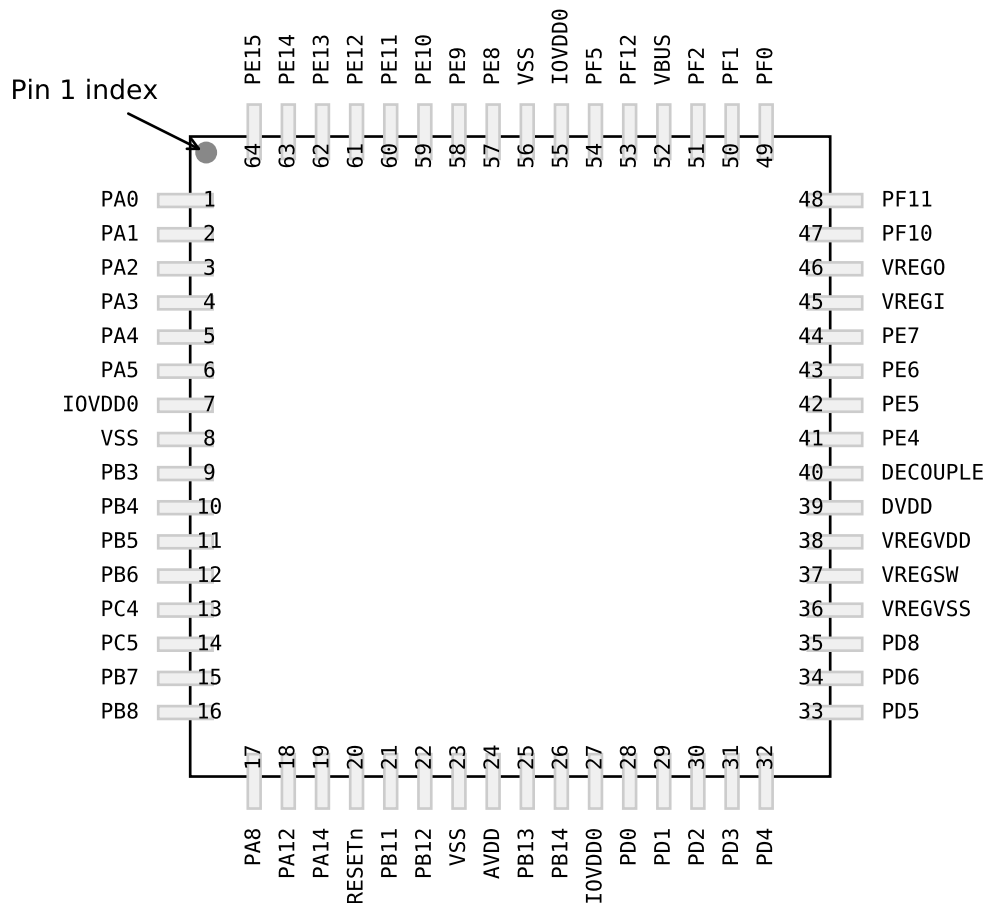

Figure 5.12. EFM32GG11B8xx in QFP64 Device Pinout

The following table provides package pin connections and general descriptions of pin functionality. For detailed information on the supported features for each GPIO pin, see [5.20 GPIO Functionality Table](#) or [5.21 Alternate Functionality Overview](#).

Table 5.12. EFM32GG11B8xx in QFP64 Device Pinout

Pin Name	Pin(s)	Description	Pin Name	Pin(s)	Description
PA0	1	GPIO	PA1	2	GPIO
PA2	3	GPIO	PA3	4	GPIO
PA4	5	GPIO	PA5	6	GPIO
IOVDD0	7 27 55	Digital IO power supply 0.	VSS	8 23 56	Ground
PB3	9	GPIO	PB4	10	GPIO
PB5	11	GPIO	PB6	12	GPIO

Pin Name	Pin(s)	Description	Pin Name	Pin(s)	Description
PC4	13	GPIO	PC5	14	GPIO
PB7	15	GPIO	PB8	16	GPIO
PA8	17	GPIO	PA12	18	GPIO (5V)
PA14	19	GPIO	RESETn	20	Reset input, active low. To apply an external reset source to this pin, it is required to only drive this pin low during reset, and let the internal pull-up ensure that reset is released.
PB11	21	GPIO	PB12	22	GPIO
AVDD	24	Analog power supply.	PB13	25	GPIO
PB14	26	GPIO	PD0	28	GPIO (5V)
PD1	29	GPIO	PD2	30	GPIO (5V)
PD3	31	GPIO	PD4	32	GPIO
PD5	33	GPIO	PD6	34	GPIO
PD8	35	GPIO	VREGVSS	36	Voltage regulator VSS
VREGSW	37	DCDC regulator switching node	VREGVDD	38	Voltage regulator VDD input
DVDD	39	Digital power supply.	DECOUPLE	40	Decouple output for on-chip voltage regulator. An external decoupling capacitor is required at this pin.
PE4	41	GPIO	PE5	42	GPIO
PE6	43	GPIO	PE7	44	GPIO
VREGI	45	Input to 5 V regulator.	VREGO	46	Decoupling for 5 V regulator and regulator output. Power for USB PHY in USB-enabled OPNs
PF10	47	GPIO (5V)	PF11	48	GPIO (5V)
PF0	49	GPIO (5V)	PF1	50	GPIO (5V)
PF2	51	GPIO	VBUS	52	USB VBUS signal and auxiliary input to 5 V regulator.
PF12	53	GPIO	PF5	54	GPIO
PE8	57	GPIO	PE9	58	GPIO
PE10	59	GPIO	PE11	60	GPIO
PE12	61	GPIO	PE13	62	GPIO
PE14	63	GPIO	PE15	64	GPIO

Note:

1. GPIO with 5V tolerance are indicated by (5V).

5.13 EFM32GG11B5xx in QFP64 Device Pinout

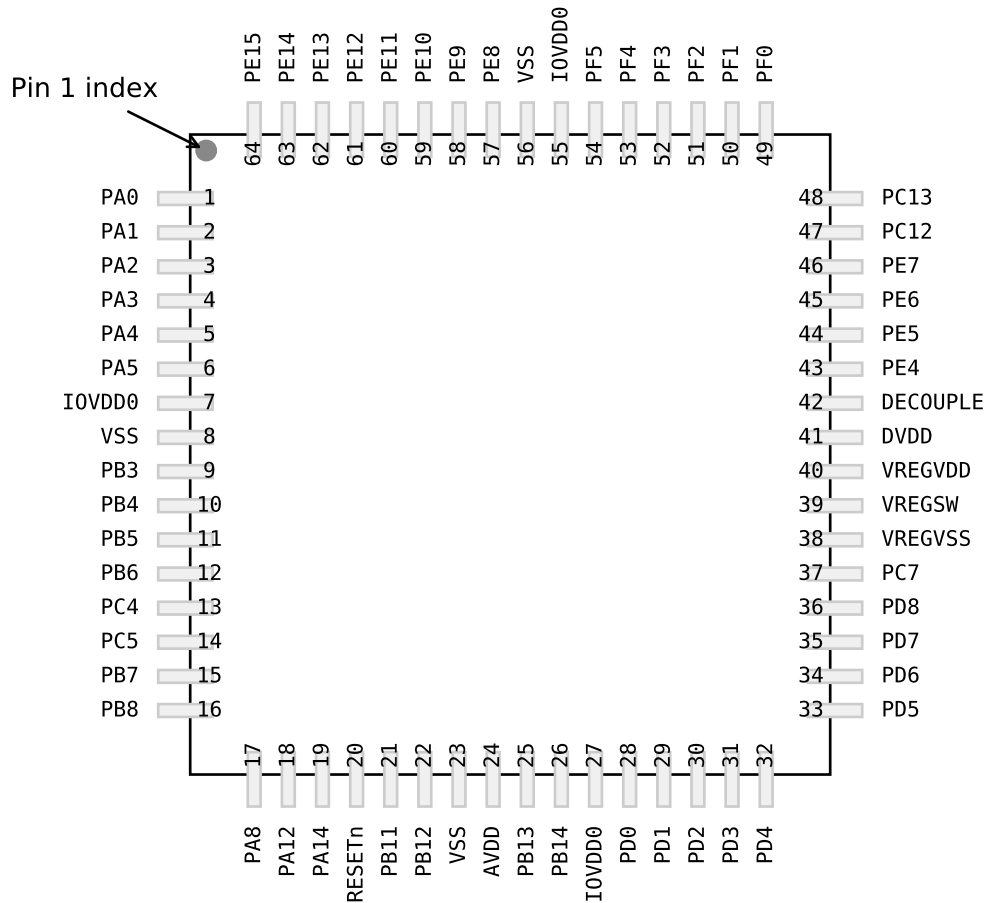

Figure 5.13. EFM32GG11B5xx in QFP64 Device Pinout

The following table provides package pin connections and general descriptions of pin functionality. For detailed information on the supported features for each GPIO pin, see [5.20 GPIO Functionality Table](#) or [5.21 Alternate Functionality Overview](#).

Table 5.13. EFM32GG11B5xx in QFP64 Device Pinout

Pin Name	Pin(s)	Description	Pin Name	Pin(s)	Description
PA0	1	GPIO	PA1	2	GPIO
PA2	3	GPIO	PA3	4	GPIO
PA4	5	GPIO	PA5	6	GPIO
IOVDD0	7 27 55	Digital IO power supply 0.	VSS	8 23 56	Ground
PB3	9	GPIO	PB4	10	GPIO
PB5	11	GPIO	PB6	12	GPIO

Pin Name	Pin(s)	Description	Pin Name	Pin(s)	Description
PC4	13	GPIO	PC5	14	GPIO
PB7	15	GPIO	PB8	16	GPIO
PA8	17	GPIO	PA12	18	GPIO (5V)
PA14	19	GPIO	RESETn	20	Reset input, active low. To apply an external reset source to this pin, it is required to only drive this pin low during reset, and let the internal pull-up ensure that reset is released.
PB11	21	GPIO	PB12	22	GPIO
AVDD	24	Analog power supply.	PB13	25	GPIO
PB14	26	GPIO	PD0	28	GPIO (5V)
PD1	29	GPIO	PD2	30	GPIO (5V)
PD3	31	GPIO	PD4	32	GPIO
PD5	33	GPIO	PD6	34	GPIO
PD7	35	GPIO	PD8	36	GPIO
PC7	37	GPIO	VREGVSS	38	Voltage regulator VSS
VREGSW	39	DCDC regulator switching node	VREGVDD	40	Voltage regulator VDD input
DVDD	41	Digital power supply.	DECOUPLE	42	Decouple output for on-chip voltage regulator. An external decoupling capacitor is required at this pin.
PE4	43	GPIO	PE5	44	GPIO
PE6	45	GPIO	PE7	46	GPIO
PC12	47	GPIO (5V)	PC13	48	GPIO (5V)
PF0	49	GPIO (5V)	PF1	50	GPIO (5V)
PF2	51	GPIO	PF3	52	GPIO
PF4	53	GPIO	PF5	54	GPIO
PE8	57	GPIO	PE9	58	GPIO
PE10	59	GPIO	PE11	60	GPIO
PE12	61	GPIO	PE13	62	GPIO
PE14	63	GPIO	PE15	64	GPIO

Note:

1. GPIO with 5V tolerance are indicated by (5V).

5.14 EFM32GG11B4xx in QFP64 Device Pinout



Figure 5.14. EFM32GG11B4xx in QFP64 Device Pinout

The following table provides package pin connections and general descriptions of pin functionality. For detailed information on the supported features for each GPIO pin, see [5.20 GPIO Functionality Table](#) or [5.21 Alternate Functionality Overview](#).

Table 5.14. EFM32GG11B4xx in QFP64 Device Pinout

Pin Name	Pin(s)	Description	Pin Name	Pin(s)	Description
PA0	1	GPIO	PA1	2	GPIO
PA2	3	GPIO	PA3	4	GPIO
PA4	5	GPIO	PA5	6	GPIO
IOVDD0	7 26 55	Digital IO power supply 0.	VSS	8 22 56	Ground
PB3	9	GPIO	PB4	10	GPIO
PB5	11	GPIO	PB6	12	GPIO

Pin Name	Pin(s)	Description	Pin Name	Pin(s)	Description
PC4	13	GPIO	PC5	14	GPIO
PB7	15	GPIO	PB8	16	GPIO
PA12	17	GPIO (5V)	PA13	18	GPIO (5V)
PA14	19	GPIO	RESETn	20	Reset input, active low. To apply an external reset source to this pin, it is required to only drive this pin low during reset, and let the internal pull-up ensure that reset is released.
PB11	21	GPIO	AVDD	23 27	Analog power supply.
PB13	24	GPIO	PB14	25	GPIO
PD0	28	GPIO (5V)	PD1	29	GPIO
PD2	30	GPIO (5V)	PD3	31	GPIO
PD4	32	GPIO	PD5	33	GPIO
PD6	34	GPIO	PD7	35	GPIO
PD8	36	GPIO	PC6	37	GPIO
PC7	38	GPIO	DVDD	39	Digital power supply.
DECOUPLE	40	Decouple output for on-chip voltage regulator. An external decoupling capacitor is required at this pin.	PE4	41	GPIO
PE5	42	GPIO	PE6	43	GPIO
PE7	44	GPIO	VREGI	45	Input to 5 V regulator.
VREGO	46	Decoupling for 5 V regulator and regulator output. Power for USB PHY in USB-enabled OPNs	PF10	47	GPIO (5V)
PF11	48	GPIO (5V)	PF0	49	GPIO (5V)
PF1	50	GPIO (5V)	PF2	51	GPIO
VBUS	52	USB VBUS signal and auxiliary input to 5 V regulator.	PF12	53	GPIO
PF5	54	GPIO	PE8	57	GPIO
PE9	58	GPIO	PE10	59	GPIO
PE11	60	GPIO	PE12	61	GPIO
PE13	62	GPIO	PE14	63	GPIO
PE15	64	GPIO			

Note:

1. GPIO with 5V tolerance are indicated by (5V).

5.15 EFM32GG11B1xx in QFP64 Device Pinout



Figure 5.15. EFM32GG11B1xx in QFP64 Device Pinout

The following table provides package pin connections and general descriptions of pin functionality. For detailed information on the supported features for each GPIO pin, see [5.20 GPIO Functionality Table](#) or [5.21 Alternate Functionality Overview](#).

Table 5.15. EFM32GG11B1xx in QFP64 Device Pinout

Pin Name	Pin(s)	Description	Pin Name	Pin(s)	Description
PA0	1	GPIO	PA1	2	GPIO
PA2	3	GPIO	PA3	4	GPIO
PA4	5	GPIO	PA5	6	GPIO
IOVDD0	7 26 55	Digital IO power supply 0.	VSS	8 22 56	Ground
PC0	9	GPIO (5V)	PC1	10	GPIO (5V)
PC2	11	GPIO (5V)	PC3	12	GPIO (5V)

Pin Name	Pin(s)	Description	Pin Name	Pin(s)	Description
PC4	13	GPIO	PC5	14	GPIO
PB7	15	GPIO	PB8	16	GPIO
PA8	17	GPIO	PA9	18	GPIO
PA10	19	GPIO	RESETn	20	Reset input, active low. To apply an external reset source to this pin, it is required to only drive this pin low during reset, and let the internal pull-up ensure that reset is released.
PB11	21	GPIO	AVDD	23 27	Analog power supply.
PB13	24	GPIO	PB14	25	GPIO
PD0	28	GPIO (5V)	PD1	29	GPIO
PD2	30	GPIO (5V)	PD3	31	GPIO
PD4	32	GPIO	PD5	33	GPIO
PD6	34	GPIO	PD7	35	GPIO
PD8	36	GPIO	PC6	37	GPIO
PC7	38	GPIO	DVDD	39	Digital power supply.
DECOUPLE	40	Decouple output for on-chip voltage regulator. An external decoupling capacitor is required at this pin.	PC8	41	GPIO (5V)
PC9	42	GPIO (5V)	PC10	43	GPIO (5V)
PC11	44	GPIO (5V)	PC12	45	GPIO (5V)
PC13	46	GPIO (5V)	PC14	47	GPIO (5V)
PC15	48	GPIO (5V)	PF0	49	GPIO (5V)
PF1	50	GPIO (5V)	PF2	51	GPIO
PF3	52	GPIO	PF4	53	GPIO
PF5	54	GPIO	PE8	57	GPIO
PE9	58	GPIO	PE10	59	GPIO
PE11	60	GPIO	PE12	61	GPIO
PE13	62	GPIO	PE14	63	GPIO
PE15	64	GPIO			

Note:

1. GPIO with 5V tolerance are indicated by (5V).

5.16 EFM32GG11B8xx in QFN64 Device Pinout



Figure 5.16. EFM32GG11B8xx in QFN64 Device Pinout

The following table provides package pin connections and general descriptions of pin functionality. For detailed information on the supported features for each GPIO pin, see [5.20 GPIO Functionality Table](#) or [5.21 Alternate Functionality Overview](#).

Table 5.16. EFM32GG11B8xx in QFN64 Device Pinout

Pin Name	Pin(s)	Description	Pin Name	Pin(s)	Description
VSS	0	Ground	PA0	1	GPIO
PA1	2	GPIO	PA2	3	GPIO
PA3	4	GPIO	PA4	5	GPIO
PA5	6	GPIO	PA6	7	GPIO
IOVDD0	8 27 55	Digital IO power supply 0.	PB3	9	GPIO
PB4	10	GPIO	PB5	11	GPIO

Pin Name	Pin(s)	Description	Pin Name	Pin(s)	Description
PB6	12	GPIO	PC4	13	GPIO
PC5	14	GPIO	PB7	15	GPIO
PB8	16	GPIO	PA8	17	GPIO
PA12	18	GPIO (5V)	PA13	19	GPIO (5V)
PA14	20	GPIO	RESETn	21	Reset input, active low. To apply an external reset source to this pin, it is required to only drive this pin low during reset, and let the internal pull-up ensure that reset is released.
PB11	22	GPIO	PB12	23	GPIO
AVDD	24	Analog power supply.	PB13	25	GPIO
PB14	26	GPIO	PD0	28	GPIO (5V)
PD1	29	GPIO	PD2	30	GPIO (5V)
PD3	31	GPIO	PD4	32	GPIO
PD5	33	GPIO	PD6	34	GPIO
PD8	35	GPIO	VREGVSS	36	Voltage regulator VSS
VREGSW	37	DCDC regulator switching node	VREGVDD	38	Voltage regulator VDD input
DVDD	39	Digital power supply.	DECOUPLE	40	Decouple output for on-chip voltage regulator. An external decoupling capacitor is required at this pin.
PE4	41	GPIO	PE5	42	GPIO
PE6	43	GPIO	PE7	44	GPIO
VREGI	45	Input to 5 V regulator.	VREGO	46	Decoupling for 5 V regulator and regulator output. Power for USB PHY in USB-enabled OPNs
PF10	47	GPIO (5V)	PF11	48	GPIO (5V)
PF0	49	GPIO (5V)	PF1	50	GPIO (5V)
PF2	51	GPIO	VBUS	52	USB VBUS signal and auxiliary input to 5 V regulator.
PF12	53	GPIO	PF5	54	GPIO
PE8	56	GPIO	PE9	57	GPIO
PE10	58	GPIO	PE11	59	GPIO
PE12	60	GPIO	PE13	61	GPIO
PE14	62	GPIO	PE15	63	GPIO
PA15	64	GPIO			

Note:

1. GPIO with 5V tolerance are indicated by (5V).

5.17 EFM32GG11B5xx in QFN64 Device Pinout



Figure 5.17. EFM32GG11B5xx in QFN64 Device Pinout

The following table provides package pin connections and general descriptions of pin functionality. For detailed information on the supported features for each GPIO pin, see [5.20 GPIO Functionality Table](#) or [5.21 Alternate Functionality Overview](#).

Table 5.17. EFM32GG11B5xx in QFN64 Device Pinout

Pin Name	Pin(s)	Description	Pin Name	Pin(s)	Description
VSS	0	Ground	PA0	1	GPIO
PA1	2	GPIO	PA2	3	GPIO
PA3	4	GPIO	PA4	5	GPIO
PA5	6	GPIO	PA6	7	GPIO
IOVDD0	8 27 55	Digital IO power supply 0.	PB3	9	GPIO
PB4	10	GPIO	PB5	11	GPIO

Pin Name	Pin(s)	Description	Pin Name	Pin(s)	Description
PB6	12	GPIO	PC4	13	GPIO
PC5	14	GPIO	PB7	15	GPIO
PB8	16	GPIO	PA8	17	GPIO
PA12	18	GPIO (5V)	PA13	19	GPIO (5V)
PA14	20	GPIO	RESETn	21	Reset input, active low. To apply an external reset source to this pin, it is required to only drive this pin low during reset, and let the internal pull-up ensure that reset is released.
PB11	22	GPIO	PB12	23	GPIO
AVDD	24	Analog power supply.	PB13	25	GPIO
PB14	26	GPIO	PD0	28	GPIO (5V)
PD1	29	GPIO	PD2	30	GPIO (5V)
PD3	31	GPIO	PD4	32	GPIO
PD5	33	GPIO	PD6	34	GPIO
PD7	35	GPIO	PD8	36	GPIO
PC7	37	GPIO	VREGVSS	38	Voltage regulator VSS
VREGSW	39	DCDC regulator switching node	VREGVDD	40	Voltage regulator VDD input
DVDD	41	Digital power supply.	DECOUPLE	42	Decouple output for on-chip voltage regulator. An external decoupling capacitor is required at this pin.
PE4	43	GPIO	PE5	44	GPIO
PE6	45	GPIO	PE7	46	GPIO
PC12	47	GPIO (5V)	PC13	48	GPIO (5V)
PF0	49	GPIO (5V)	PF1	50	GPIO (5V)
PF2	51	GPIO	PF3	52	GPIO
PF4	53	GPIO	PF5	54	GPIO
PE8	56	GPIO	PE9	57	GPIO
PE10	58	GPIO	PE11	59	GPIO
PE12	60	GPIO	PE13	61	GPIO
PE14	62	GPIO	PE15	63	GPIO
PA15	64	GPIO			

Note:

1. GPIO with 5V tolerance are indicated by (5V).

5.18 EFM32GG11B4xx in QFN64 Device Pinout



Figure 5.18. EFM32GG11B4xx in QFN64 Device Pinout

The following table provides package pin connections and general descriptions of pin functionality. For detailed information on the supported features for each GPIO pin, see [5.20 GPIO Functionality Table](#) or [5.21 Alternate Functionality Overview](#).

Table 5.18. EFM32GG11B4xx in QFN64 Device Pinout

Pin Name	Pin(s)	Description	Pin Name	Pin(s)	Description
VSS	0	Ground	PA0	1	GPIO
PA1	2	GPIO	PA2	3	GPIO
PA3	4	GPIO	PA4	5	GPIO
PA5	6	GPIO	PA6	7	GPIO
IOVDD0	8 26 55	Digital IO power supply 0.	PB3	9	GPIO
PB4	10	GPIO	PB5	11	GPIO

Pin Name	Pin(s)	Description	Pin Name	Pin(s)	Description
PB6	12	GPIO	PC4	13	GPIO
PC5	14	GPIO	PB7	15	GPIO
PB8	16	GPIO	PA12	17	GPIO (5V)
PA13	18	GPIO (5V)	PA14	19	GPIO
RESETn	20	Reset input, active low. To apply an external reset source to this pin, it is required to only drive this pin low during reset, and let the internal pull-up ensure that reset is released.	PB11	21	GPIO
PB12	22	GPIO	AVDD	23 27	Analog power supply.
PB13	24	GPIO	PB14	25	GPIO
PD0	28	GPIO (5V)	PD1	29	GPIO
PD2	30	GPIO (5V)	PD3	31	GPIO
PD4	32	GPIO	PD5	33	GPIO
PD6	34	GPIO	PD7	35	GPIO
PD8	36	GPIO	PC6	37	GPIO
PC7	38	GPIO	DVDD	39	Digital power supply.
DECOUPLE	40	Decouple output for on-chip voltage regulator. An external decoupling capacitor is required at this pin.	PE4	41	GPIO
PE5	42	GPIO	PE6	43	GPIO
PE7	44	GPIO	VREGI	45	Input to 5 V regulator.
VREGO	46	Decoupling for 5 V regulator and regulator output. Power for USB PHY in USB-enabled OPNs	PF10	47	GPIO (5V)
PF11	48	GPIO (5V)	PF0	49	GPIO (5V)
PF1	50	GPIO (5V)	PF2	51	GPIO
VBUS	52	USB VBUS signal and auxiliary input to 5 V regulator.	PF12	53	GPIO
PF5	54	GPIO	PE8	56	GPIO
PE9	57	GPIO	PE10	58	GPIO
PE11	59	GPIO	PE12	60	GPIO
PE13	61	GPIO	PE14	62	GPIO
PE15	63	GPIO	PA15	64	GPIO

Note:

1. GPIO with 5V tolerance are indicated by (5V).

5.19 EFM32GG11B1xx in QFN64 Device Pinout



Figure 5.19. EFM32GG11B1xx in QFN64 Device Pinout

The following table provides package pin connections and general descriptions of pin functionality. For detailed information on the supported features for each GPIO pin, see [5.20 GPIO Functionality Table](#) or [5.21 Alternate Functionality Overview](#).

Table 5.19. EFM32GG11B1xx in QFN64 Device Pinout

Pin Name	Pin(s)	Description	Pin Name	Pin(s)	Description
VSS	0	Ground	PA0	1	GPIO
PA1	2	GPIO	PA2	3	GPIO
PA3	4	GPIO	PA4	5	GPIO
PA5	6	GPIO	PA6	7	GPIO
IOVDD0	8 26 55	Digital IO power supply 0.	PC0	9	GPIO (5V)
PC1	10	GPIO (5V)	PC2	11	GPIO (5V)

Pin Name	Pin(s)	Description	Pin Name	Pin(s)	Description
PC3	12	GPIO (5V)	PC4	13	GPIO
PC5	14	GPIO	PB7	15	GPIO
PB8	16	GPIO	PA8	17	GPIO
PA9	18	GPIO	PA10	19	GPIO
RESETn	20	Reset input, active low. To apply an external reset source to this pin, it is required to only drive this pin low during reset, and let the internal pull-up ensure that reset is released.	PB11	21	GPIO
PB12	22	GPIO	AVDD	23 27	Analog power supply.
PB13	24	GPIO	PB14	25	GPIO
PD0	28	GPIO (5V)	PD1	29	GPIO
PD2	30	GPIO (5V)	PD3	31	GPIO
PD4	32	GPIO	PD5	33	GPIO
PD6	34	GPIO	PD7	35	GPIO
PD8	36	GPIO	PC6	37	GPIO
PC7	38	GPIO	DVDD	39	Digital power supply.
DECOUPLE	40	Decouple output for on-chip voltage regulator. An external decoupling capacitor is required at this pin.	PC8	41	GPIO (5V)
PC9	42	GPIO (5V)	PC10	43	GPIO (5V)
PC11	44	GPIO (5V)	PC12	45	GPIO (5V)
PC13	46	GPIO (5V)	PC14	47	GPIO (5V)
PC15	48	GPIO (5V)	PF0	49	GPIO (5V)
PF1	50	GPIO (5V)	PF2	51	GPIO
PF3	52	GPIO	PF4	53	GPIO
PF5	54	GPIO	PE8	56	GPIO
PE9	57	GPIO	PE10	58	GPIO
PE11	59	GPIO	PE12	60	GPIO
PE13	61	GPIO	PE14	62	GPIO
PE15	63	GPIO	PA15	64	GPIO

Note:

1. GPIO with 5V tolerance are indicated by (5V).

5.20 GPIO Functionality Table

A wide selection of alternate functionality is available for multiplexing to various pins. The following table shows the name of each GPIO pin, followed by the functionality available on that pin. Refer to [5.21 Alternate Functionality Overview](#) for a list of GPIO locations available for each function.

Table 5.20. GPIO Functionality Table

GPIO Name	Pin Alternate Functionality / Description				
	Analog	EBI	Timers	Communication	Other
PA0	BUSBY BUSAX LCD_SEG13	EBI_AD09 #0 EBI_CSTFT #3	TIM0_CC0 #0 TIM0_CC1 #7 TIM3_CC0 #4 PCNT0_S0IN #4	ETH_RMIITXEN #0 ETH_MIITXCLK #0 SDIO_DAT0 #1 US1_RX #5 US3_TX #0 QSPI0_CS0 #1 LEU0_RX #4 I2C0_SDA #0	CMU_CLK2 #0 PRS_CH0 #0 PRS_CH3 #3 GPIO_EM4WU0
PA1	BUSAY BUSBX LCD_SEG14	EBI_AD10 #0 EBI_DCLK #3	TIM0_CC0 #7 TIM0_CC1 #0 TIM3_CC1 #4 PCNT0_S1IN #4	ETH_RMIIRXD1 #0 ETH_MIITXD3 #0 SDIO_DAT1 #1 US3_RX #0 QSPI0_CS1 #1 I2C0_SCL #0	CMU_CLK1 #0 PRS_CH1 #0
PA2	BUSBY BUSAX LCD_SEG15	EBI_AD11 #0 EBI_DTEN #3	TIM0_CC2 #0 TIM3_CC2 #4	ETH_RMIIRXD0 #0 ETH_MIITXD2 #0 SDIO_DAT2 #1 US1_RX #6 US3_CLK #0 QSPI0_DQ0 #1	CMU_CLK0 #0 PRS_CH8 #1 ETM_TD0 #3
PA3	BUSAY BUSBX LCD_SEG16	EBI_AD12 #0 EBI_VSNC #3	TIM0_CDTI0 #0 TIM3_CC0 #5	ETH_RMIIREFCLK #0 ETH_MIITXD1 #0 SDIO_DAT3 #1 US3_CS #0 U0_TX #2 QSPI0_DQ1 #1	CMU_CLK2 #1 CMU_CLKI0 #1 CMU_CLK2 #4 LES_ALTEX2 PRS_CH9 #1 ETM_TD1 #3
PA4	BUSBY BUSAX LCD_SEG17	EBI_AD13 #0 EBI_HSNC #3	TIM0_CDTI1 #0 TIM3_CC1 #5	ETH_RMIICRSVDV #0 ETH_MIITXD0 #0 SDIO_DAT4 #1 US3_CTS #0 U0_RX #2 QSPI0_DQ2 #1	LES_ALTEX3 PRS_CH16 #0 ETM_TD2 #3
PA5	BUSAY BUSBX LCD_SEG18	EBI_AD14 #0	TIM0_CDTI2 #0 TIM3_CC2 #5 PCNT1_S0IN #0	ETH_RMIIRXER #0 ETH_MIITXEN #0 SDIO_DAT5 #1 US3_RTS #0 U0_CTS #2 QSPI0_DQ3 #1 LEU1_TX #1	LES_ALTEX4 PRS_CH17 #0 ACMP1_O #7 ETM_TD3 #3
PA6	BUSBY BUSAX LCD_SEG19	EBI_AD15 #0	TIM3_CC0 #6 WTIM0_CC0 #1 LE- TIM1_OUT1 #0 PCNT1_S1IN #0	ETH_MIITXER #0 ETH_MDC #3 SDIO_CD #2 US5_TX #1 U0_RTS #2 LEU1_RX #1	PRS_CH6 #0 ACMP0_O #4 ETM_TCLK #3 GPIO_EM4WU1
PA7	BUSAY BUSBX LCD_SEG35	EBI_AD13 #1 EBI_A01 #3 EBI_CSTFT #0	TIM0_CC2 #5 LE- TIM1_OUT0 #0 PCNT1_S0IN #4	US2_TX #2 US4_CTS #0 US5_RX #1	PRS_CH7 #1

GPIO Name	Pin Alternate Functionality / Description				
	Analog	EBI	Timers	Communication	Other
PA8	BUSBY BUSAX LCD_SEG36	EBI_AD14 #1 EBI_A02 #3 EBI_DCLK #0	TIM2_CC0 #0 TIM0_CC0 #6 LE- TIM0_OUT0 #6 PCNT1_S1IN #4	US2_RX #2 US4_RTS #0	PRS_CH8 #0
PA9	BUSAY BUSBX LCD_SEG37	EBI_AD15 #1 EBI_A03 #3 EBI_DTEN #0	TIM2_CC1 #0 TIM0_CC1 #6 WTIM2_CC0 #0 LE- TIM0_OUT1 #6	US2_CLK #2	PRS_CH9 #0
PA10	BUSBY BUSAX LCD_SEG38	EBI_CS0 #1 EBI_A04 #3 EBI_VSNC #0	TIM2_CC2 #0 TIM0_CC2 #6 WTIM2_CC1 #0	US2_CS #2	PRS_CH10 #0
PA11	BUSAY BUSBX LCD_SEG39	EBI_CS1 #1 EBI_A05 #3 EBI_HSNC #0	WTIM2_CC2 #0 LE- TIM1_OUT0 #1	US2_CTS #2	PRS_CH11 #0
PA12	BUSBY BUSAX	EBI_CS2 #1 EBI_REn #2 EBI_A00 #0 EBI_A06 #3	TIM2_CC0 #1 WTIM0_CDTI0 #2 WTIM2_CC0 #1 LE- TIM1_OUT0 #2 PCNT1_S0IN #5	CAN1_RX #5 US0_CLK #5 US2_RTS #2	CMU_CLK0 #5 PRS_CH12 #0 ACMP1_O #3
PA13	BUSAY BUSBX	EBI_WEn #1 EBI_NANDWEn #2 EBI_A01 #0 EBI_A07 #3	TIM0_CC2 #7 TIM2_CC1 #1 WTIM0_CDTI1 #2 WTIM2_CC1 #1 LE- TIM1_OUT1 #1 PCNT1_S1IN #5	CAN1_TX #5 US0_CS #5 US2_TX #3	PRS_CH13 #0
PA14	BUSBY BUSAX LCD_BEXT	EBI_REn #1 EBI_A02 #0 EBI_A08 #3	TIM2_CC2 #1 WTIM0_CDTI2 #2 WTIM2_CC2 #1 LE- TIM1_OUT1 #2	US1_TX #6 US2_RX #3 US3_RTS #2	PRS_CH14 #0 ACMP1_O #4
PA15	BUSAY BUSBX LCD_SEG12	EBI_AD08 #0	TIM3_CC2 #0	ETH_MIIIRXCLK #0 ETH_MDIO #3 US2_CLK #3	PRS_CH15 #0
PB0	BUSBY BUSAX LCD_SEG32	EBI_AD00 #1 EBI_CS0 #3 EBI_A16 #0	TIM2_CDTI0 #0 TIM1_CC0 #2 TIM3_CC2 #7 WTIM0_CC0 #5 PCNT0_S0IN #5 PCNT1_S1IN #2	LEU1_TX #3	PRS_CH4 #1 ACMP0_O #5
PB1	BUSAY BUSBX LCD_SEG33	EBI_AD01 #1 EBI_CS1 #3 EBI_A17 #0	TIM2_CDTI1 #0 TIM1_CC1 #2 WTIM0_CC1 #5 LE- TIM1_OUT1 #5 PCNT0_S1IN #5	ETH_MIIICRS #0 US5_RX #2 LEU1_RX #3	PRS_CH5 #1
PB2	BUSBY BUSAX LCD_SEG34	EBI_AD02 #1 EBI_CS2 #3 EBI_A18 #0	TIM2_CDTI2 #0 TIM1_CC2 #2 WTIM0_CC2 #5 LE- TIM1_OUT0 #5	ETH_MIIICOL #0 US1_CS #6	PRS_CH18 #0 ACMP0_O #6
PB3	BUSAY BUSBX LCD_SEG20 / LCD_COM4	EBI_AD03 #1 EBI_CS3 #3 EBI_A19 #0	TIM1_CC3 #2 WTIM0_CC0 #6 PCNT1_S0IN #1	ETH_MIIICRS #2 ETH_MDIO #0 SDIO_DAT6 #1 US2_TX #1 US3_TX #2 QSPI0_DQ4 #1	PRS_CH19 #0 ACMP0_O #7

GPIO Name	Pin Alternate Functionality / Description				
	Analog	EBI	Timers	Communication	Other
PB4	BUSBY BUSAX LCD_SEG21 / LCD_COM5	EBI_AD04 #1 EBI_ARDY #3 EBI_A20 #0	WTIM0_CC1 #6 PCNT1_S1IN #1	ETH_MIICOL #2 ETH_MDC #0 SDIO_DAT7 #1 US2_RX #1 QSPIO_DQ5 #1 LEU1_TX #4	PRS_CH20 #0
PB5	BUSAY BUSBX LCD_SEG22 / LCD_COM6	EBI_AD05 #1 EBI_ALE #3 EBI_A21 #0	WTIM0_CC2 #6 LE- TIM1_OUT0 #4 PCNT0_S0IN #6	ETH_TSUEXTCLK #0 US0_RTS #4 US2_CLK #1 QSPIO_DQ6 #1 LEU1_RX #4	PRS_CH21 #0
PB6	BUSBY BUSAX LCD_SEG23 / LCD_COM7	EBI_AD06 #1 EBI_WEn #3 EBI_A22 #0	TIM0_CC0 #3 TIM2_CC0 #4 WTIM3_CC0 #6 LE- TIM1_OUT1 #4 PCNT0_S1IN #6	ETH_TSUTMRTOG #0 US0_CTS #4 US2_CS #1 QSPIO_DQ7 #1	PRS_CH12 #1
PB7	LFXTAL_P		TIM0_CDTI0 #4 TIM1_CC0 #3	US0_TX #4 US1_CLK #0 US3_RX #2 US4_TX #0 U0_CTS #4	PRS_CH22 #0
PB8	LFXTAL_N		TIM0_CDTI1 #4 TIM1_CC1 #3	US0_RX #4 US1_CS #0 US4_RX #0 U0_RTS #4	CMU_CLKI0 #2 PRS_CH23 #0
PB9	BUSAY BUSBX	EBI_ALE #1 EBI_NANDREn #2 EBI_A00 #1 EBI_A03 #0 EBI_A09 #3	WTIM2_CC0 #2 LE- TIM0_OUT0 #7	SDIO_WP #3 CAN0_RX #3 US1_CTS #0 U1_TX #2	PRS_CH13 #1 ACMP1_O #5
PB10	BUSBY BUSAX	EBI_BL0 #2 EBI_A01 #1 EBI_A04 #0 EBI_A10 #3	WTIM2_CC1 #2 LE- TIM0_OUT1 #7	SDIO_CD #3 CAN0_TX #3 US1_RTS #0 US2_CTS #3 U1_RX #2	PRS_CH9 #2 ACMP1_O #6
PB11	BUSAY BUSBX VDAC0_OUT0 / OPA0_OUT IDAC0_OUT	EBI_BL1 #2 EBI_A02 #1 EBI_A11 #3	TIM0_CDTI2 #4 TIM1_CC2 #3 WTIM2_CC2 #2 LE- TIM0_OUT0 #1 PCNT0_S1IN #7 PCNT1_S0IN #6	US0_CTS #5 US1_CLK #5 US2_CS #3 US5_CLK #0 U1_CTS #2 I2C1_SDA #1	CMU_CLK1 #5 CMU_CLKI0 #7 PRS_CH21 #2 ACMP0_O #3 GPIO_EM4WU7
PB12	BUSBY BUSAX VDAC0_OUT1 / OPA1_OUT	EBI_A03 #1 EBI_A12 #3 EBI_CSTFT #2	TIM1_CC3 #3 WTIM2_CC0 #3 LE- TIM0_OUT1 #1 PCNT0_S0IN #7 PCNT1_S1IN #6	US2_CTS #1 US5_RTS #0 U1_RTS #2 I2C1_SCL #1	PRS_CH16 #1
PB13	BUSAY BUSBX HFXTAL_P		TIM6_CC0 #5 WTIM1_CC0 #0 PCNT2_S0IN #2	US0_CLK #4 US1_CTS #5 US5_CS #0 LEU0_TX #1	CMU_CLKI0 #3 PRS_CH7 #0
PB14	BUSBY BUSAX HFXTAL_N		TIM6_CC1 #5 WTIM1_CC1 #0 PCNT2_S1IN #2	US0_CS #4 US1_RTS #5 US5_CTS #0 LEU0_RX #1	PRS_CH6 #1

GPIO Name	Pin Alternate Functionality / Description				
	Analog	EBI	Timers	Communication	Other
PB15	BUSAY BUSBX	EBI_CS3 #1 EBI_AR-DY #2	TIM3_CC1 #7	ETH_TSUTMRTOG #1 SDIO_WP #2 US2_RTS #1 US5_RTS #1	PRS_CH17 #1 ETM_TD2 #1
PC0	VDAC0_OUT0ALT / OPA0_OUTALT #0 BUSACMP0Y BUSACMP0X	EBI_AD07 #1 EBI_CS0 #2 EBI_REn #3 EBI_A23 #0	TIM0_CC1 #3 TIM2_CC1 #4 PCNT0_S0IN #2	ETH_MDIO #2 CAN0_RX #0 US0_TX #5 US1_TX #0 US1_CS #4 US2_RTS #0 US3_CS #3 I2C0_SDA #4	LES_CH0 PRS_CH2 #0
PC1	VDAC0_OUT0ALT / OPA0_OUTALT #1 BUSACMP0Y BUSACMP0X	EBI_AD08 #1 EBI_CS1 #2 EBI_BLO #3 EBI_A24 #0	TIM0_CC2 #3 TIM2_CC2 #4 WTIM0_CC0 #7 PCNT0_S1IN #2	ETH_MDC #2 CAN0_TX #0 US0_RX #5 US1_TX #4 US1_RX #0 US2_CTS #0 US3_RTS #1 I2C0_SCL #4	LES_CH1 PRS_CH3 #0
PC2	VDAC0_OUT0ALT / OPA0_OUTALT #2 BUSACMP0Y BUSACMP0X	EBI_AD09 #1 EBI_CS2 #2 EBI_NANDWEn #3 EBI_A25 #0	TIM0_CDTI0 #3 TIM2_CC0 #5 WTIM0_CC1 #7 LE-TIM1_OUT0 #3	ETH_TSUEXTCLK #2 CAN1_RX #0 US1_RX #4 US2_TX #0	LES_CH2 PRS_CH10 #1
PC3	VDAC0_OUT0ALT / OPA0_OUTALT #3 BUSACMP0Y BUSACMP0X	EBI_AD10 #1 EBI_CS3 #2 EBI_BL1 #3 EBI_NANDREn #0	TIM0_CDTI1 #3 TIM2_CC1 #5 WTIM0_CC2 #7 LE-TIM1_OUT1 #3	ETH_TSUTMRTOG #2 CAN1_TX #0 US1_CLK #4 US2_RX #0	LES_CH3 PRS_CH11 #1
PC4	BUSACMP0Y BUSACMP0X OPA0_P	EBI_AD11 #1 EBI_ALE #2 EBI_NANDREn #3 EBI_A26 #0	TIM0_CC0 #5 TIM0_CDTI2 #3 TIM2_CC2 #5 LE-TIM0_OUT0 #3 PCNT1_S0IN #3	SDIO_CD #1 US2_CLK #0 US4_CLK #0 U0_TX #4 U1_CTS #4 I2C1_SDA #0	LES_CH4 PRS_CH18 #2 GPIO_EM4WU6
PC5	BUSACMP0Y BUSACMP0X OPA0_N	EBI_AD12 #1 EBI_WEn #2 EBI_NANDWEn #0 EBI_A00 #3	TIM0_CC1 #5 LE-TIM0_OUT1 #3 PCNT1_S1IN #3	SDIO_WP #1 US2_CS #0 US4_CS #0 U0_RX #4 U1_RTS #4 I2C1_SCL #0	LES_CH5 PRS_CH19 #2
PC6	BUSACMP0Y BUSACMP0X OPA3_P	EBI_A05 #0	WTIM1_CC3 #2	US0_RTS #2 US1_CTS #3 LEU1_TX #0 I2C0_SDA #2	LES_CH6 PRS_CH14 #1 ETM_TCLK #2
PC7	BUSACMP0Y BUSACMP0X OPA3_N	EBI_A06 #0 EBI_A13 #1 EBI_A21 #3	WTIM1_CC0 #3	US0_CTS #2 US1_RTS #3 LEU1_RX #0 I2C0_SCL #2	LES_CH7 PRS_CH15 #1 ETM_TD0 #2
PC8	BUSACMP1Y BUSACMP1X	EBI_A08 #2 EBI_A15 #0 EBI_A20 #1 EBI_A26 #3	TIM2_CC0 #2 TIM5_CC0 #4 WTIM3_CC0 #1	US0_CS #2	LES_CH8 PRS_CH4 #0
PC9	BUSACMP1Y BUSACMP1X	EBI_A09 #2 EBI_A21 #1 EBI_A27 #3	TIM2_CC1 #2 TIM5_CC1 #4 WTIM3_CC1 #1	CAN1_RX #3 US0_CLK #2	LES_CH9 PRS_CH5 #0 GPIO_EM4WU2
PC10	BUSACMP1Y BUSACMP1X	EBI_A10 #2 EBI_A22 #1	TIM2_CC2 #2 TIM5_CC2 #4 WTIM3_CC2 #1	CAN1_TX #3 US0_RX #2	LES_CH10 PRS_CH18 #1

GPIO Name	Pin Alternate Functionality / Description				
	Analog	EBI	Timers	Communication	Other
PC11	BUSACMP1Y BU-SACMP1X	EBI_ALE #4 EBI_ALE #5 EBI_A23 #1	TIM5_CC0 #5 WTIM3_CC0 #2	CAN1_TX #4 US0_TX #2 I2C1_SDA #4	LES_CH11 PRS_CH19 #1
PC12	VDAC0_OUT1ALT / OPA1_OUTALT #0 BUSACMP1Y BU-SACMP1X		TIM1_CC3 #0 TIM5_CC1 #5 WTIM3_CC1 #2 PCNT2_S0IN #4	CAN1_RX #4 US0_RTS #3 US1_CTS #4 US2_CTS #4 U0_RTS #3 U1_TX #0 I2C2_SDA #6	CMU_CLK0 #1 LES_CH12 PRS_CH20 #1
PC13	VDAC0_OUT1ALT / OPA1_OUTALT #1 BUSACMP1Y BU-SACMP1X	EBI_ARDY #4	TIM0_CDTI0 #1 TIM1_CC0 #0 TIM1_CC2 #4 TIM5_CC2 #5 WTIM3_CC2 #2 PCNT0_S0IN #0 PCNT2_S1IN #4	US0_CTS #3 US1_RTS #4 US2_RTS #4 U0_CTS #3 U1_RX #0 I2C2_SCL #6	LES_CH13 PRS_CH21 #1 ACMP3_O #3
PC14	VDAC0_OUT1ALT / OPA1_OUTALT #2 BUSACMP1Y BU-SACMP1X	EBI_NANDWE _n #4	TIM0_CDTI1 #1 TIM1_CC1 #0 TIM1_CC3 #4 TIM5_CC0 #6 WTIM3_CC0 #3 LE- TIM0_OUT0 #5 PCNT0_S1IN #0	US0_CS #3 US1_CS #3 US2_RTS #3 US3_CS #2 U0_TX #3 U1_CTS #0 LEU0_TX #5 I2C2_SDA #1	LES_CH14 PRS_CH0 #2 ACMP3_O #2
PC15	VDAC0_OUT1ALT / OPA1_OUTALT #3 BUSACMP1Y BU-SACMP1X	EBI_NANDRE _n #4	TIM0_CDTI2 #1 TIM1_CC2 #0 WTIM0_CC0 #4 LE- TIM0_OUT1 #5	US0_CLK #3 US1_CLK #3 US3_RTS #3 U0_RX #3 U1_RTS #0 LEU0_RX #5 I2C2_SCL #1	LES_CH15 PRS_CH1 #2 ACMP3_O #1 DBG_SWO #1
PD0	VDAC0_OUT0ALT / OPA0_OUTALT #4 OPA2_OUTALT BU-SADC0Y BUSADC0X	EBI_A04 #1 EBI_A13 #3	TIM4_CDTI0 TIM6_CC2 #5 WTIM1_CC2 #0 PCNT2_S0IN #0	CAN0_RX #2 US1_TX #1	
PD1	VDAC0_OUT1ALT / OPA1_OUTALT #4 BUSADC0Y BU-SADC0X OPA3_OUT	EBI_A05 #1 EBI_A14 #3	TIM4_CDTI1 TIM0_CC0 #2 TIM6_CC0 #6 WTIM1_CC3 #0 PCNT2_S1IN #0	CAN0_TX #2 US1_RX #1	DBG_SWO #2
PD2	BUSADC0Y BU-SADC0X	EBI_A06 #1 EBI_A15 #3 EBI_A27 #0	TIM0_CC1 #2 TIM6_CC1 #6 WTIM1_CC0 #1	US1_CLK #1 LEU1_TX #2	DBG_SWO #3
PD3	BUSADC0Y BU-SADC0X OPA2_N	EBI_A07 #1 EBI_A16 #3	TIM4_CDTI2 TIM0_CC2 #2 TIM6_CC2 #6 WTIM1_CC1 #1 WTIM2_CC0 #5	CAN1_RX #2 US1_CS #1 LEU1_RX #2	ETM_TD1 #0 ETM_TD1 #2
PD4	BUSADC0Y BU-SADC0X OPA2_P	EBI_A08 #1 EBI_A17 #3	TIM6_CC0 #7 WTIM0_CDTI0 #4 WTIM1_CC2 #1 WTIM2_CC1 #5	CAN1_TX #2 US1_CTS #1 US3_CLK #2 LEU0_TX #0 I2C1_SDA #3	CMU_CLKI0 #0 PRS_CH10 #2 ETM_TD2 #0 ETM_TD2 #2

GPIO Name	Pin Alternate Functionality / Description				
	Analog	EBI	Timers	Communication	Other
PD5	BUSADC0Y BU-SADC0X OPA2_OUT	EBI_A09 #1 EBI_A18 #3	TIM6_CC1 #7 WTIM0_CDT1 #4 WTIM1_CC3 #1 WTIM2_CC2 #5	US1_RTS #1 U0_CTS #5 LEU0_RX #0 I2C1_SCL #3	PRS_CH11 #2 ETM_TD3 #0 ETM_TD3 #2
PD6	BUSADC0Y BU-SADC0X ADC0_EXTP VDAC0_EXT ADC1_EXTP OPA1_P	EBI_A10 #1 EBI_A19 #3	TIM1_CC0 #4 TIM6_CC2 #7 WTIM0_CDT2 #4 WTIM1_CC0 #2 LE- TIM0_OUT0 #0 PCNT0_S0IN #3	US0_RTS #5 US1_RX #2 US2_CTS #5 US3_CTS #2 U0_RTS #5 I2C0_SDA #1	CMU_CLK2 #2 LES_ALTEX0 PRS_CH5 #2 ACMP0_O #2 ETM_TD0 #0
PD7	BUSADC0Y BU-SADC0X ADC0_EXTN ADC1_EXTN OPA1_N	EBI_A11 #1 EBI_A20 #3	TIM1_CC1 #4 WTIM1_CC1 #2 LE- TIM0_OUT1 #0 PCNT0_S1IN #3	US1_TX #2 US3_CLK #1 U0_TX #6 I2C0_SCL #1	CMU_CLK0 #2 LES_ALTEX1 ACMP1_O #2 ETM_TCLK #0
PD8	BU_VIN	EBI_A12 #1	WTIM1_CC2 #2	US2_RTS #5	CMU_CLK1 #1 PRS_CH12 #2 ACMP2_O #0
PD9	LCD_SEG28	EBI_CS0 #0 EBI_DTEN #1	TIM4_CC1 #5 WTIM3_CC0 #0	ETH_RMIIRXD0 #1 SDIO_DAT7 #0 QSPI0_DQ0 #0 ETH_MIIRXD1 #2 US4_TX #1	
PD10	LCD_SEG29	EBI_CS1 #0 EBI_VSNC #1	TIM4_CC2 #5 WTIM3_CC1 #0	ETH_RMIIREFCLK #1 SDIO_DAT6 #0 QSPI0_DQ1 #0 ETH_MIIRXD2 #2 US4_RX #1	CMU_CLK2 #5 CMU_CLKI0 #5
PD11	LCD_SEG30	EBI_CS2 #0 EBI_HSNC #1	TIM4_CC0 #6 WTIM3_CC2 #0	ETH_RMIICRS0V #1 SDIO_DAT5 #0 QSPI0_DQ2 #0 ETH_MIIRXD3 #2 US4_CLK #1	
PD12	LCD_SEG31	EBI_CS3 #0	TIM4_CC1 #6	ETH_RMIIRXER #1 SDIO_DAT4 #0 QSPI0_DQ3 #0 ETH_MIIRXCLK #2 US4_CS #1	
PD13		EBI_ARDY #1	TIM2_CDTI0 #1 TIM3_CC1 #6 WTIM0_CC1 #1	ETH_MDIO #1 US4_CTS #1 US5_CLK #1	ETM_TD1 #1
PD14		EBI_NANDWE _n #1	TIM2_CDTI1 #1 TIM3_CC2 #6 WTIM0_CC2 #1	ETH_MDC #1 CAN0_RX #5 US4_RTS #1 US5_CS #1 I2C0_SDA #3	
PD15		EBI_NANDRE _n #1	TIM2_CDTI2 #1 TIM3_CC0 #7 WTIM0_CDTI0 #1 PCNT1_S0IN #2	ETH_TSUEXTCLK #1 CAN0_TX #5 US5_CTS #1 I2C0_SCL #3	
PE0	BUSDY BUSCX	EBI_A00 #2 EBI_A07 #0	TIM3_CC0 #1 WTIM1_CC1 #3 PCNT0_S0IN #1	CAN0_RX #6 U0_TX #1 I2C1_SDA #2	PRS_CH22 #1 ACMP2_O #1

GPIO Name	Pin Alternate Functionality / Description				
	Analog	EBI	Timers	Communication	Other
PE1	BUSCY BUSDX	EBI_A01 #2 EBI_A08 #0	TIM3_CC1 #1 WTIM1_CC2 #3 PCNT0_S1IN #1	CAN0_TX #6 U0_RX #1 I2C1_SCL #2	CMU_CLKI0 #4 PRS_CH23 #1 ACMP2_O #2
PE2	BU_VOUT	EBI_A09 #0 EBI_A14 #1	TIM3_CC2 #1 WTIM1_CC3 #3	US0_RTS #1 U0_CTS #1 U1_TX #3	PRS_CH20 #2 ACMP0_O #1
PE3	BU_STAT	EBI_A10 #0 EBI_A15 #1	TIM3_CC0 #2 WTIM1_CC0 #4	US0_CTS #1 U0_RTS #1 U1_RX #3	ACMP1_O #1
PE4	BUSDY BUSCX LCD_COM0	EBI_A11 #0 EBI_A16 #1 EBI_A22 #3	TIM3_CC1 #2 TIM5_CC0 #0 TIM6_CDTI0 #2 WTIM0_CC0 #0 WTIM1_CC1 #4	US0_CS #1 US1_CS #5 US3_CS #1 U0_RX #6 U1_CTS #3 I2C0_SDA #7	PRS_CH16 #2
PE5	BUSCY BUSDX LCD_COM1	EBI_A12 #0 EBI_A17 #1 EBI_A23 #3	TIM3_CC0 #3 TIM3_CC2 #2 TIM5_CC1 #0 TIM6_CDTI1 #2 WTIM0_CC1 #0 WTIM1_CC2 #4	US0_CLK #1 US1_CLK #6 US3_CTS #1 U1_RTS #3 I2C0_SCL #7	PRS_CH17 #2
PE6	BUSDY BUSCX LCD_COM2	EBI_A13 #0 EBI_A18 #1 EBI_A24 #3	TIM3_CC1 #3 TIM5_CC2 #0 TIM6_CDTI2 #2 WTIM0_CC2 #0 WTIM1_CC3 #4	US0_RX #1 US3_TX #1	PRS_CH6 #2
PE7	BUSCY BUSDX LCD_COM3	EBI_A14 #0 EBI_A19 #1 EBI_A25 #3	TIM3_CC2 #3 TIM5_CC0 #1 WTIM1_CC0 #5	US0_TX #1 US3_RX #1	PRS_CH7 #2
PE8	BUSDY BUSCX LCD_SEG4	EBI_AD00 #0 EBI_CS0 #4	TIM2_CDTI0 #2 TIM4_CC2 #6 PCNT2_S0IN #1	SDIO_DAT3 #0 QSPI0_DQ4 #0 US5_TX #0 I2C2_SDA #0	PRS_CH3 #1
PE9	BUSCY BUSDX LCD_SEG5	EBI_AD01 #0 EBI_CS1 #4	TIM4_CC0 #7 PCNT2_S1IN #1	SDIO_DAT2 #0 QSPI0_DQ5 #0 US5_RX #0	PRS_CH8 #2
PE10	BUSDY BUSCX LCD_SEG6	EBI_AD02 #0 EBI_CS2 #4	TIM1_CC0 #1 TIM4_CC1 #7 WTIM0_CDTI0 #0	SDIO_DAT1 #0 QSPI0_DQ6 #0 ETH_MII_RXER #0 US0_TX #0	PRS_CH2 #2 GPIO_EM4WU9
PE11	BUSCY BUSDX LCD_SEG7	EBI_AD03 #0 EBI_CS3 #4	TIM1_CC1 #1 TIM4_CC2 #7 WTIM0_CDTI1 #0	SDIO_DAT0 #0 QSPI0_DQ7 #0 ETH_MII_RXDV #0 US0_RX #0	LES_ALTEX5 PRS_CH3 #2 ETM_TCLK #4
PE12	BUSDY BUSCX LCD_SEG8	EBI_AD04 #0	TIM1_CC2 #1 TIM2_CC1 #3 WTIM0_CDTI2 #0 LETIM0_OUT0 #4	SDIO_CMD #0 ETH_MII_RXD0 #0 US0_RX #3 US0_CLK #0 U1_TX #4 I2C0_SDA #6	CMU_CLK1 #2 CMU_CLKI0 #6 LES_ALTEX6 PRS_CH1 #3 ETM_TD0 #4
PE13	BUSCY BUSDX LCD_SEG9	EBI_AD05 #0	TIM1_CC3 #1 TIM2_CC2 #3 LE- TIM0_OUT1 #4	SDIO_CLK #0 ETH_MII_RXD1 #0 US0_TX #3 US0_CS #0 U1_RX #4 I2C0_SCL #6	LES_ALTEX7 PRS_CH2 #3 ACMP0_O #0 ETM_TD1 #4 GPIO_EM4WU5

GPIO Name	Pin Alternate Functionality / Description				
	Analog	EBI	Timers	Communication	Other
PE14	BUSDY BUSCX LCD_SEG10	EBI_AD06 #0	TIM2_CDTI1 #2 TIM3_CC0 #0	ETH_RMII_TXD1 #0 ETH_MII_RXD2 #0 SDIO_CLK #1 US0_CTS #0 QSPI0_SCLK #1 LEU0_TX #2	PRS_CH13 #2 ETM_TD2 #4
PE15	BUSCY BUSDX LCD_SEG11	EBI_AD07 #0	TIM2_CDTI2 #2 TIM3_CC1 #0	ETH_RMII_TXD0 #0 ETH_MII_RXD3 #0 SDIO_CMD #1 US0_RTS #0 QSPI0_DQS #1 LEU0_RX #2	PRS_CH14 #2 ETM_TD3 #4
PF0	BUSDY BUSCX	EBI_A24 #1	TIM0_CC0 #4 WTIM0_CC1 #4 LE- TIM0_OUT0 #2	US2_TX #5 CAN0_RX #1 US1_CLK #2 LEU0_TX #3 I2C0_SDA #5	PRS_CH15 #2 ACMP3_O #0 DBG_SWCLKTCK BOOT_TX
PF1	BUSCY BUSDX	EBI_A25 #1	TIM0_CC1 #4 WTIM0_CC2 #4 LE- TIM0_OUT1 #2	US2_RX #5 CAN1_RX #1 US1_CS #2 U0_TX #5 LEU0_RX #3 I2C0_SCL #5	PRS_CH4 #2 DBG_SWDIOTMS GPIO_EM4WU3 BOOT_RX
PF2	BUSDY BUSCX LCD_SEG0	EBI_ARDY #0 EBI_A26 #1	TIM0_CC2 #4 TIM1_CC0 #5 TIM2_CC0 #3	US2_CLK #5 CAN0_TX #1 US1_TX #5 U0_RX #5 LEU0_TX #4 I2C1_SCL #4	CMU_CLK0 #4 PRS_CH0 #3 ACMP1_O #0 DBG_TDO DBG_SWO #0 GPIO_EM4WU4
PF3	BUSCY BUSDX LCD_SEG1	EBI_ALE #0	TIM4_CC0 #0 TIM0_CDTI0 #2 TIM1_CC1 #5	CAN1_TX #1 US1_CTS #2 I2C2_SCL #5	CMU_CLK1 #4 PRS_CH0 #1 ETM_TD3 #1
PF4	BUSDY BUSCX LCD_SEG2	EBI_WEn #0 EBI_WEn #5	TIM4_CC1 #0 TIM0_CDTI1 #2 TIM1_CC2 #5 WTIM3_CC1 #6	US1_RTS #2 I2C2_SDA #3	PRS_CH1 #1
PF5	BUSCY BUSDX LCD_SEG3	EBI_REn #0 EBI_REn #5 EBI_A27 #1	TIM0_CDTI2 #2 TIM1_CC3 #6 TIM4_CC0 #2	US2_CS #5 I2C2_SCL #0 USB_VBUSEN	PRS_CH2 #1 DBG_TDI
PF6	BUSDY BUSCX LCD_SEG24	EBI_BLO #0 EBI_BLO #4 EBI_BLO #5 EBI_CSTFT #1	TIM0_CC0 #1 TIM4_CC0 #4 WTIM3_CC2 #5	ETH_RMII_TXD1 #1 US2_TX #4 QSPI0_SCLK #0 US1_TX #3 U0_TX #0	PRS_CH22 #2
PF7	BUSCY BUSDX LCD_SEG25	EBI_BL1 #0 EBI_BL1 #4 EBI_BL1 #5 EBI_DCLK #1	TIM0_CC1 #1 TIM4_CC1 #4	ETH_RMII_TXD0 #1 US2_RX #4 QSPI0_CS0 #0 ETH_MII_RXER #2 US1_RX #3 U0_RX #0	PRS_CH23 #2

GPIO Name	Pin Alternate Functionality / Description				
	Analog	EBI	Timers	Communication	Other
PF8	BUSDY BUSCX LCD_SEG26	EBI_WEn #4 EBI_BL0 #1	TIM0_CC2 #1 TIM4_CC2 #4	ETH_RMIITXEN #1 US2_CLK #4 QSPI0_CS1 #0 ETH_MIIRXDV #2 ETH_TSUEXTCLK #3 SDIO_CD #0 U0_CTS #0 U1_RTS #1	ETM_TCLK #1 GPIO_EM4WU8
PF9	BUSCY BUSDX LCD_SEG27	EBI_REn #4 EBI_BL1 #1	TIM4_CC0 #5	ETH_RMIIRXD1 #1 US2_CS #4 QSPI0_DQS #0 ETH_MIIRXD0 #2 ETH_TSUTMRTOG #3 SDIO_WP #0 U0_RTS #0 U1_CTS #1	ETM_TD0 #1
PF10	BUSDY BUSCX	EBI_ARDY #5	TIM5_CC1 #6 WTIM3_CC1 #3 PCNT2_S0IN #3	US5_RTS #2 U1_TX #1 I2C2_SDA #2 USB_DM	
PF11	BUSCY BUSDX	EBI_NANDWEn #5	TIM5_CC2 #6 WTIM3_CC2 #3 PCNT2_S1IN #3	US5_CTS #2 U1_RX #1 I2C2_SCL #2 USB_DP	
PF12	BUSDY BUSCX	EBI_NANDREn #5	TIM4_CC2 #0 TIM1_CC3 #5 TIM5_CC0 #7 WTIM3_CC2 #6	US5_CS #2 I2C2_SCL #3 USB_ID	
PF13	BUSCY BUSDX		TIM1_CC0 #6 TIM4_CC0 #1 TIM5_CC1 #7 WTIM3_CC0 #7	US5_CLK #2 I2C2_SDA #4	
PF14	BUSDY BUSCX		TIM1_CC1 #6 TIM4_CC1 #1 TIM5_CC2 #7 WTIM3_CC1 #7	I2C2_SCL #4	
PF15	BUSCY BUSDX		TIM1_CC2 #6 TIM4_CC2 #1 WTIM3_CC2 #7	US5_TX #2 I2C2_SDA #5	
PG0	BUSACMP2Y BU- SACMP2X	EBI_AD00 #2	TIM6_CC0 #0 TIM2_CDTI0 #3 WTIM0_CDTI1 #1 LETIM1_OUT0 #6	ETH_MIITXCLK #1 US3_TX #4 QSPI0_SCLK #2	CMU_CLK2 #3
PG1	BUSACMP2Y BU- SACMP2X	EBI_AD01 #2	TIM6_CC1 #0 TIM2_CDTI1 #3 WTIM0_CDTI2 #1 LETIM1_OUT1 #6	ETH_MIITXD3 #1 US3_RX #4 QSPI0_DQ0 #2	CMU_CLK1 #3
PG2	BUSACMP2Y BU- SACMP2X	EBI_AD02 #2	TIM6_CC2 #0 TIM2_CDTI2 #3 WTIM0_CC0 #2 LE- TIM1_OUT0 #7	ETH_MIITXD2 #1 US3_CLK #4 QSPI0_DQ1 #2	CMU_CLK0 #3
PG3	BUSACMP2Y BU- SACMP2X	EBI_AD03 #2	TIM6_CDTI0 #0 WTIM0_CC1 #2 LE- TIM1_OUT1 #7	ETH_MIITXD1 #1 US3_CS #4 QSPI0_DQ2 #2	

GPIO Name	Pin Alternate Functionality / Description				
	Analog	EBI	Timers	Communication	Other
PG4	BUSACMP2Y BU-SACMP2X	EBI_AD04 #2	TIM6_CDTI1 #0 WTIM0_CC2 #2	ETH_MIITXD0 #1 US3_CTS #4 QSPI0_DQ3 #2	
PG5	BUSACMP2Y BU-SACMP2X	EBI_AD05 #2	TIM6_CDTI2 #0 TIM2_CC0 #7	ETH_MIITXEN #1 US3_RTS #4 QSPI0_DQ4 #2	
PG6	BUSACMP2Y BU-SACMP2X	EBI_AD06 #2	TIM2_CC1 #7 TIM6_CC0 #1	ETH_MIITXER #1 US3_TX #3 QSPI0_DQ5 #2	
PG7	BUSACMP2Y BU-SACMP2X	EBI_AD07 #2	TIM2_CC2 #7 TIM6_CC1 #1	ETH_MIIRXCLK #1 US3_RX #3 QSPI0_DQ6 #2	
PG8		EBI_AD08 #2	TIM2_CC0 #6 TIM6_CC2 #1 WTIM0_CC0 #3	ETH_MIIRXD3 #1 CAN0_RX #4 US3_CLK #3 QSPI0_DQ7 #2	
PG9		EBI_AD09 #2	TIM2_CC1 #6 TIM6_CDTI0 #1 WTIM0_CC1 #3	ETH_MIIRXD2 #1 CAN0_TX #4 US3_CTS #5 QSPI0_CS0 #2	
PG10		EBI_AD10 #2	TIM2_CC2 #6 TIM6_CDTI1 #1 WTIM0_CC2 #3	ETH_MIIRXD1 #1 CAN1_RX #6 US3_CTS #3 QSPI0_CS1 #2	
PG11		EBI_AD11 #2	TIM6_CDTI2 #1 WTIM0_CDTI0 #3	ETH_MIIRXD0 #1 CAN1_TX #6 US3_RTS #5 QSPI0_DQS #2	ETM_TD3 #5
PG12		EBI_AD12 #2	TIM6_CC0 #2 WTIM0_CDTI1 #3 WTIM2_CC1 #3	ETH_MIIRXDV #1 US0_TX #6	ETM_TD2 #5
PG13		EBI_AD13 #2	TIM6_CC1 #2 WTIM0_CDTI2 #3 WTIM2_CC2 #3	ETH_MIIRXER #1 US0_RX #6	ETM_TD1 #5
PG14		EBI_AD14 #2	TIM6_CC2 #2 WTIM2_CC0 #4 PCNT1_S0IN #7	ETH_MII CRS #1 US0_CLK #6	ETM_TD0 #5
PG15		EBI_AD15 #2	WTIM2_CC1 #4 PCNT1_S1IN #7	ETH_MII COL #1 US0_CS #6	ETM_TCLK #5
PH0	BUSADC1Y BU-SADC1X	EBI_DCLK #2	WTIM2_CC2 #4	US0_CTS #6 LEU1_TX #5	
PH1	BUSADC1Y BU-SADC1X	EBI_DTEN #2		US0_RTS #6 LEU1_RX #5	
PH2	BUSADC1Y BU-SADC1X	EBI_VSNC #2	TIM6_CC0 #3	US1_CTS #6	
PH3	BUSADC1Y BU-SADC1X	EBI_HSNC #2	TIM6_CC1 #3	US1_RTS #6	
PH4	BUSADC1Y BU-SADC1X	EBI_A16 #2	TIM6_CC2 #3 WTIM2_CC0 #6	US4_TX #4	

GPIO Name	Pin Alternate Functionality / Description				
	Analog	EBI	Timers	Communication	Other
PH5	BUSADC1Y BU-SADC1X	EBI_A17 #2	TIM6_CDTI0 #3 WTIM2_CC1 #6	US4_RX #4	
PH6	BUSADC1Y BU-SADC1X	EBI_A18 #2	TIM6_CDTI1 #3 WTIM2_CC2 #6	US4_CLK #4	
PH7	BUSADC1Y BU-SADC1X	EBI_A19 #2	TIM6_CDTI2 #3 WTIM2_CC0 #7	US4_CS #4	
PH8	BUSACMP3Y BU-SACMP3X	EBI_A20 #2	TIM6_CC0 #4 WTIM1_CC0 #6 WTIM2_CC1 #7	US4_CTS #4	
PH9	BUSACMP3Y BU-SACMP3X	EBI_A21 #2	TIM6_CC1 #4 WTIM1_CC1 #6 WTIM2_CC2 #7	US4_RTS #4	
PH10	BUSACMP3Y BU-SACMP3X	EBI_A22 #2	TIM6_CC2 #4 WTIM1_CC2 #6	US5_TX #3	
PH11	BUSACMP3Y BU-SACMP3X	EBI_A23 #2	TIM5_CC1 #1 WTIM1_CC3 #6	US5_RX #3 U1_TX #5 I2C1_SDA #5	
PH12	BUSACMP3Y BU-SACMP3X	EBI_A24 #2	TIM5_CC2 #1 WTIM1_CC0 #7	US5_CLK #3 U1_RX #5 I2C1_SCL #5	
PH13	BUSACMP3Y BU-SACMP3X	EBI_A25 #2	TIM5_CC0 #2 WTIM1_CC1 #7 PCNT2_S1IN #7	US5_CS #3 U1_CTS #5 I2C1_SDA #6	
PH14	BUSACMP3Y BU-SACMP3X	EBI_A26 #2	TIM5_CC1 #2 WTIM1_CC2 #7 PCNT2_S0IN #7	US5_CTS #3 U1_RTS #5 I2C1_SCL #6	
PH15	BUSACMP3Y BU-SACMP3X	EBI_A27 #2	TIM5_CC2 #2 WTIM1_CC3 #7 PCNT2_S1IN #6	US5_RTS #3	
PI0		EBI_A02 #2	TIM5_CC0 #3 WTIM1_CC1 #5 PCNT2_S0IN #6	US4_TX #2	ACMP2_O #3
PI1		EBI_A03 #2	TIM5_CC1 #3 WTIM1_CC2 #5 PCNT2_S1IN #5	US4_RX #2	ACMP2_O #4
PI2		EBI_A04 #2	TIM5_CC2 #3 WTIM1_CC3 #5 PCNT2_S0IN #5	US4_CLK #2 I2C1_SDA #7	ACMP2_O #5
PI3		EBI_A05 #2	WTIM3_CC0 #4	US4_CS #2 I2C1_SCL #7	
PI4		EBI_A06 #2	WTIM3_CC1 #4	US4_CTS #2 I2C2_SDA #7	ACMP3_O #4
PI5		EBI_A07 #2	WTIM3_CC2 #4	US4_RTS #2 I2C2_SCL #7	ACMP3_O #5
PI6		EBI_A11 #2	TIM1_CC0 #7 TIM4_CC1 #2 WTIM3_CC0 #5	US4_TX #3	
PI7		EBI_A12 #2	TIM1_CC1 #7 TIM4_CC2 #2 WTIM3_CC1 #5	US4_RX #3	

GPIO Name	Pin Alternate Functionality / Description				
	Analog	EBI	Timers	Communication	Other
PI8		EBI_A13 #2	TIM1_CC2 #7 TIM4_CC0 #3	US4_CLK #3	
PI9		EBI_A14 #2	TIM1_CC3 #7 TIM4_CC1 #3	US4_CS #3	
PI10		EBI_A15 #2	TIM4_CC2 #3	US4_CTS #3	
PI11				US4_RTS #3	
PI12				CAN0_RX #7 US3_TX #5	
PI13				CAN0_TX #7 US3_RX #5	
PI14				CAN1_RX #7 US3_CLK #5	
PI15				CAN1_TX #7 US3_CS #5	

5.21 Alternate Functionality Overview

A wide selection of alternate functionality is available for multiplexing to various pins. The following table shows the name of the alternate functionality in the first column, followed by columns showing the possible LOCATION bitfield settings and the associated GPIO pin. Refer to [5.20 GPIO Functionality Table](#) for a list of functions available on each GPIO pin.

Note: Some functionality, such as analog interfaces, do not have alternate settings or a LOCATION bitfield. In these cases, the pinout is shown in the column corresponding to LOCATION 0.

Table 5.21. Alternate Functionality Overview

Alternate Functionality	LOCATION		Description
	0 - 3	4 - 7	
ACMP0_O	0: PE13 1: PE2 2: PD6 3: PB11	4: PA6 5: PB0 6: PB2 7: PB3	Analog comparator ACMP0, digital output.
ACMP1_O	0: PF2 1: PE3 2: PD7 3: PA12	4: PA14 5: PB9 6: PB10 7: PA5	Analog comparator ACMP1, digital output.
ACMP2_O	0: PD8 1: PE0 2: PE1 3: PI0	4: PI1 5: PI2	Analog comparator ACMP2, digital output.
ACMP3_O	0: PF0 1: PC15 2: PC14 3: PC13	4: PI4 5: PI5	Analog comparator ACMP3, digital output.
ADC0_EXTN	0: PD7		Analog to digital converter ADC0 external reference input negative pin.
ADC0_EXTP	0: PD6		Analog to digital converter ADC0 external reference input positive pin.
ADC1_EXTN	0: PD7		Analog to digital converter ADC1 external reference input negative pin.
ADC1_EXTP	0: PD6		Analog to digital converter ADC1 external reference input positive pin.
BOOT_RX	0: PF1		Bootloader RX.
BOOT_TX	0: PF0		Bootloader TX.

Alternate	LOCATION		Description
	0 - 3	4 - 7	
BU_STAT	0: PE3		Backup Power Domain status, whether or not the system is in backup mode.
BU_VIN	0: PD8		Battery input for Backup Power Domain.
BU_VOUT	0: PE2		Power output for Backup Power Domain.
CAN0_RX	0: PC0 1: PF0 2: PD0 3: PB9	4: PG8 5: PD14 6: PE0 7: PI12	CAN0 RX.
CAN0_TX	0: PC1 1: PF2 2: PD1 3: PB10	4: PG9 5: PD15 6: PE1 7: PI13	CAN0 TX.
CAN1_RX	0: PC2 1: PF1 2: PD3 3: PC9	4: PC12 5: PA12 6: PG10 7: PI14	CAN1 RX.
CAN1_TX	0: PC3 1: PF3 2: PD4 3: PC10	4: PC11 5: PA13 6: PG11 7: PI15	CAN1 TX.
CMU_CLK0	0: PA2 1: PC12 2: PD7 3: PG2	4: PF2 5: PA12	Clock Management Unit, clock output number 0.
CMU_CLK1	0: PA1 1: PD8 2: PE12 3: PG1	4: PF3 5: PB11	Clock Management Unit, clock output number 1.
CMU_CLK2	0: PA0 1: PA3 2: PD6 3: PG0	4: PA3 5: PD10	Clock Management Unit, clock output number 2.
CMU_CLKI0	0: PD4 1: PA3 2: PB8 3: PB13	4: PE1 5: PD10 6: PE12 7: PB11	Clock Management Unit, clock input number 0.
DBG_SWCLKTCK	0: PF0		Debug-interface Serial Wire clock input and JTAG Test Clock. Note that this function is enabled to the pin out of reset, and has a built-in pull down.
DBG_SWDIOTMS	0: PF1		Debug-interface Serial Wire data input / output and JTAG Test Mode Select. Note that this function is enabled to the pin out of reset, and has a built-in pull up.

Alternate	LOCATION		Description
	0 - 3	4 - 7	
DBG_SWO	0: PF2 1: PC15 2: PD1 3: PD2		Debug-interface Serial Wire viewer Output. Note that this function is not enabled after reset, and must be enabled by software to be used.
DBG_TDI	0: PF5		Debug-interface JTAG Test Data In. Note that this function becomes available after the first valid JTAG command is received, and has a built-in pull up when JTAG is active.
DBG_TDO	0: PF2		Debug-interface JTAG Test Data Out. Note that this function becomes available after the first valid JTAG command is received.
EBI_A00	0: PA12 1: PB9 2: PE0 3: PC5		External Bus Interface (EBI) address output pin 00.
EBI_A01	0: PA13 1: PB10 2: PE1 3: PA7		External Bus Interface (EBI) address output pin 01.
EBI_A02	0: PA14 1: PB11 2: PI0 3: PA8		External Bus Interface (EBI) address output pin 02.
EBI_A03	0: PB9 1: PB12 2: PI1 3: PA9		External Bus Interface (EBI) address output pin 03.
EBI_A04	0: PB10 1: PD0 2: PI2 3: PA10		External Bus Interface (EBI) address output pin 04.
EBI_A05	0: PC6 1: PD1 2: PI3 3: PA11		External Bus Interface (EBI) address output pin 05.
EBI_A06	0: PC7 1: PD2 2: PI4 3: PA12		External Bus Interface (EBI) address output pin 06.
EBI_A07	0: PE0 1: PD3 2: PI5 3: PA13		External Bus Interface (EBI) address output pin 07.
EBI_A08	0: PE1 1: PD4 2: PC8 3: PA14		External Bus Interface (EBI) address output pin 08.
EBI_A09	0: PE2 1: PD5 2: PC9 3: PB9		External Bus Interface (EBI) address output pin 09.

Alternate	LOCATION		Description
	0 - 3	4 - 7	
EBI_A10	0: PE3 1: PD6 2: PC10 3: PB10		External Bus Interface (EBI) address output pin 10.
EBI_A11	0: PE4 1: PD7 2: PI6 3: PB11		External Bus Interface (EBI) address output pin 11.
EBI_A12	0: PE5 1: PD8 2: PI7 3: PB12		External Bus Interface (EBI) address output pin 12.
EBI_A13	0: PE6 1: PC7 2: PI8 3: PD0		External Bus Interface (EBI) address output pin 13.
EBI_A14	0: PE7 1: PE2 2: PI9 3: PD1		External Bus Interface (EBI) address output pin 14.
EBI_A15	0: PC8 1: PE3 2: PI10 3: PD2		External Bus Interface (EBI) address output pin 15.
EBI_A16	0: PB0 1: PE4 2: PH4 3: PD3		External Bus Interface (EBI) address output pin 16.
EBI_A17	0: PB1 1: PE5 2: PH5 3: PD4		External Bus Interface (EBI) address output pin 17.
EBI_A18	0: PB2 1: PE6 2: PH6 3: PD5		External Bus Interface (EBI) address output pin 18.
EBI_A19	0: PB3 1: PE7 2: PH7 3: PD6		External Bus Interface (EBI) address output pin 19.
EBI_A20	0: PB4 1: PC8 2: PH8 3: PD7		External Bus Interface (EBI) address output pin 20.
EBI_A21	0: PB5 1: PC9 2: PH9 3: PC7		External Bus Interface (EBI) address output pin 21.
EBI_A22	0: PB6 1: PC10 2: PH10 3: PE4		External Bus Interface (EBI) address output pin 22.

Alternate	LOCATION		Description
	0 - 3	4 - 7	
EBI_A23	0: PC0 1: PC11 2: PH11 3: PE5		External Bus Interface (EBI) address output pin 23.
EBI_A24	0: PC1 1: PF0 2: PH12 3: PE6		External Bus Interface (EBI) address output pin 24.
EBI_A25	0: PC2 1: PF1 2: PH13 3: PE7		External Bus Interface (EBI) address output pin 25.
EBI_A26	0: PC4 1: PF2 2: PH14 3: PC8		External Bus Interface (EBI) address output pin 26.
EBI_A27	0: PD2 1: PF5 2: PH15 3: PC9		External Bus Interface (EBI) address output pin 27.
EBI_AD00	0: PE8 1: PB0 2: PG0		External Bus Interface (EBI) address and data input / output pin 00.
EBI_AD01	0: PE9 1: PB1 2: PG1		External Bus Interface (EBI) address and data input / output pin 01.
EBI_AD02	0: PE10 1: PB2 2: PG2		External Bus Interface (EBI) address and data input / output pin 02.
EBI_AD03	0: PE11 1: PB3 2: PG3		External Bus Interface (EBI) address and data input / output pin 03.
EBI_AD04	0: PE12 1: PB4 2: PG4		External Bus Interface (EBI) address and data input / output pin 04.
EBI_AD05	0: PE13 1: PB5 2: PG5		External Bus Interface (EBI) address and data input / output pin 05.
EBI_AD06	0: PE14 1: PB6 2: PG6		External Bus Interface (EBI) address and data input / output pin 06.
EBI_AD07	0: PE15 1: PC0 2: PG7		External Bus Interface (EBI) address and data input / output pin 07.

Alternate	LOCATION		Description
	0 - 3	4 - 7	
EBI_AD08	0: PA15 1: PC1 2: PG8		External Bus Interface (EBI) address and data input / output pin 08.
EBI_AD09	0: PA0 1: PC2 2: PG9		External Bus Interface (EBI) address and data input / output pin 09.
EBI_AD10	0: PA1 1: PC3 2: PG10		External Bus Interface (EBI) address and data input / output pin 10.
EBI_AD11	0: PA2 1: PC4 2: PG11		External Bus Interface (EBI) address and data input / output pin 11.
EBI_AD12	0: PA3 1: PC5 2: PG12		External Bus Interface (EBI) address and data input / output pin 12.
EBI_AD13	0: PA4 1: PA7 2: PG13		External Bus Interface (EBI) address and data input / output pin 13.
EBI_AD14	0: PA5 1: PA8 2: PG14		External Bus Interface (EBI) address and data input / output pin 14.
EBI_AD15	0: PA6 1: PA9 2: PG15		External Bus Interface (EBI) address and data input / output pin 15.
EBI_ALE	0: PF3 1: PB9 2: PC4 3: PB5	4: PC11 5: PC11	External Bus Interface (EBI) Address Latch Enable output.
EBI_ARDY	0: PF2 1: PD13 2: PB15 3: PB4	4: PC13 5: PF10	External Bus Interface (EBI) Hardware Ready Control input.
EBI_BL0	0: PF6 1: PF8 2: PB10 3: PC1	4: PF6 5: PF6	External Bus Interface (EBI) Byte Lane/Enable pin 0.
EBI_BL1	0: PF7 1: PF9 2: PB11 3: PC3	4: PF7 5: PF7	External Bus Interface (EBI) Byte Lane/Enable pin 1.
EBI_CS0	0: PD9 1: PA10 2: PC0 3: PB0	4: PE8	External Bus Interface (EBI) Chip Select output 0.

Alternate	LOCATION		
Functionality	0 - 3	4 - 7	Description
EBI_CS1	0: PD10 1: PA11 2: PC1 3: PB1	4: PE9	External Bus Interface (EBI) Chip Select output 1.
EBI_CS2	0: PD11 1: PA12 2: PC2 3: PB2	4: PE10	External Bus Interface (EBI) Chip Select output 2.
EBI_CS3	0: PD12 1: PB15 2: PC3 3: PB3	4: PE11	External Bus Interface (EBI) Chip Select output 3.
EBI_CSTFT	0: PA7 1: PF6 2: PB12 3: PA0		External Bus Interface (EBI) Chip Select output TFT.
EBI_DCLK	0: PA8 1: PF7 2: PH0 3: PA1		External Bus Interface (EBI) TFT Dot Clock pin.
EBI_DTEN	0: PA9 1: PD9 2: PH1 3: PA2		External Bus Interface (EBI) TFT Data Enable pin.
EBI_HSNc	0: PA11 1: PD11 2: PH3 3: PA4		External Bus Interface (EBI) TFT Horizontal Synchronization pin.
EBI_NANDREn	0: PC3 1: PD15 2: PB9 3: PC4	4: PC15 5: PF12	External Bus Interface (EBI) NAND Read Enable output.
EBI_NANDWEn	0: PC5 1: PD14 2: PA13 3: PC2	4: PC14 5: PF11	External Bus Interface (EBI) NAND Write Enable output.
EBI_REn	0: PF5 1: PA14 2: PA12 3: PC0	4: PF9 5: PF5	External Bus Interface (EBI) Read Enable output.
EBI_VSNc	0: PA10 1: PD10 2: PH2 3: PA3		External Bus Interface (EBI) TFT Vertical Synchronization pin.
EBI_WEn	0: PF4 1: PA13 2: PC5 3: PB6	4: PF8 5: PF4	External Bus Interface (EBI) Write Enable output.
ETH_MDC	0: PB4 1: PD14 2: PC1 3: PA6		Ethernet Management Data Clock.

Alternate	LOCATION		Description
	0 - 3	4 - 7	
ETH_MDIO	0: PB3 1: PD13 2: PC0 3: PA15		Ethernet Management Data I/O.
ETH_MIICOL	0: PB2 1: PG15 2: PB4		Ethernet MII Collision Detect.
ETH_MIICRS	0: PB1 1: PG14 2: PB3		Ethernet MII Carrier Sense.
ETH_MIIRXCLK	0: PA15 1: PG7 2: PD12		Ethernet MII Receive Clock.
ETH_MIIRXD0	0: PE12 1: PG11 2: PF9		Ethernet MII Receive Data Bit 0.
ETH_MIIRXD1	0: PE13 1: PG10 2: PD9		Ethernet MII Receive Data Bit 1.
ETH_MIIRXD2	0: PE14 1: PG9 2: PD10		Ethernet MII Receive Data Bit 2.
ETH_MIIRXD3	0: PE15 1: PG8 2: PD11		Ethernet MII Receive Data Bit 3.
ETH_MIIRXDV	0: PE11 1: PG12 2: PF8		Ethernet MII Receive Data Valid.
ETH_MIIRXER	0: PE10 1: PG13 2: PF7		Ethernet MII Receive Error.
ETH_MIITXCLK	0: PA0 1: PG0		Ethernet MII Transmit Clock.
ETH_MIITXD0	0: PA4 1: PG4		Ethernet MII Transmit Data Bit 0.
ETH_MIITXD1	0: PA3 1: PG3		Ethernet MII Transmit Data Bit 1.

Alternate	LOCATION		Description
	0 - 3	4 - 7	
ETH_MIITXD2	0: PA2 1: PG2		Ethernet MII Transmit Data Bit 2.
ETH_MIITXD3	0: PA1 1: PG1		Ethernet MII Transmit Data Bit 3.
ETH_MIITXEN	0: PA5 1: PG5		Ethernet MII Transmit Enable.
ETH_MIITXER	0: PA6 1: PG6		Ethernet MII Transmit Error.
ETH_RMIICRSVDV	0: PA4 1: PD11		Ethernet RMII Carrier Sense / Data Valid.
ETH_RMIIREFCLK	0: PA3 1: PD10		Ethernet RMII Reference Clock.
ETH_RMIIRXD0	0: PA2 1: PD9		Ethernet RMII Receive Data Bit 0.
ETH_RMIIRXD1	0: PA1 1: PF9		Ethernet RMII Receive Data Bit 1.
ETH_RMIIRXER	0: PA5 1: PD12		Ethernet RMII Receive Error.
ETH_RMIITXD0	0: PE15 1: PF7		Ethernet RMII Transmit Data Bit 0.
ETH_RMIITXD1	0: PE14 1: PF6		Ethernet RMII Transmit Data Bit 1.
ETH_RMIITXEN	0: PA0 1: PF8		Ethernet RMII Transmit Enable.
ETH_TSUEXTCLK	0: PB5 1: PD15 2: PC2 3: PF8		Ethernet IEEE1588 External Reference Clock.

Alternate	LOCATION		Description
	0 - 3	4 - 7	
ETH_TSUTMR-TOG	0: PB6 1: PB15 2: PC3 3: PF9		Ethernet IEEE1588 Timer Toggle.
ETM_TCLK	0: PD7 1: PF8 2: PC6 3: PA6	4: PE11 5: PG15	Embedded Trace Module ETM clock .
ETM_TD0	0: PD6 1: PF9 2: PC7 3: PA2	4: PE12 5: PG14	Embedded Trace Module ETM data 0.
ETM_TD1	0: PD3 1: PD13 2: PD3 3: PA3	4: PE13 5: PG13	Embedded Trace Module ETM data 1.
ETM_TD2	0: PD4 1: PB15 2: PD4 3: PA4	4: PE14 5: PG12	Embedded Trace Module ETM data 2.
ETM_TD3	0: PD5 1: PF3 2: PD5 3: PA5	4: PE15 5: PG11	Embedded Trace Module ETM data 3.
GPIO_EM4WU0	0: PA0		Pin can be used to wake the system up from EM4
GPIO_EM4WU1	0: PA6		Pin can be used to wake the system up from EM4
GPIO_EM4WU2	0: PC9		Pin can be used to wake the system up from EM4
GPIO_EM4WU3	0: PF1		Pin can be used to wake the system up from EM4
GPIO_EM4WU4	0: PF2		Pin can be used to wake the system up from EM4
GPIO_EM4WU5	0: PE13		Pin can be used to wake the system up from EM4
GPIO_EM4WU6	0: PC4		Pin can be used to wake the system up from EM4

Alternate	LOCATION		Description
	0 - 3	4 - 7	
GPIO_EM4WU7	0: PB11		Pin can be used to wake the system up from EM4
GPIO_EM4WU8	0: PF8		Pin can be used to wake the system up from EM4
GPIO_EM4WU9	0: PE10		Pin can be used to wake the system up from EM4
HFXTAL_N	0: PB14		High Frequency Crystal negative pin. Also used as external optional clock input pin.
HFXTAL_P	0: PB13		High Frequency Crystal positive pin.
I2C0_SCL	0: PA1 1: PD7 2: PC7 3: PD15	4: PC1 5: PF1 6: PE13 7: PE5	I2C0 Serial Clock Line input / output.
I2C0_SDA	0: PA0 1: PD6 2: PC6 3: PD14	4: PC0 5: PF0 6: PE12 7: PE4	I2C0 Serial Data input / output.
I2C1_SCL	0: PC5 1: PB12 2: PE1 3: PD5	4: PF2 5: PH12 6: PH14 7: PI3	I2C1 Serial Clock Line input / output.
I2C1_SDA	0: PC4 1: PB11 2: PE0 3: PD4	4: PC11 5: PH11 6: PH13 7: PI2	I2C1 Serial Data input / output.
I2C2_SCL	0: PF5 1: PC15 2: PF11 3: PF12	4: PF14 5: PF3 6: PC13 7: PI5	I2C2 Serial Clock Line input / output.
I2C2_SDA	0: PE8 1: PC14 2: PF10 3: PF4	4: PF13 5: PF15 6: PC12 7: PI4	I2C2 Serial Data input / output.
IDAC0_OUT	0: PB11		IDAC0 output.

Alternate	LOCATION		Description
	0 - 3	4 - 7	
LCD_BEXT	0: PA14		<p>LCD external supply bypass in step down or charge pump mode. If using the LCD in step-down or charge pump mode, a 1 uF (minimum) capacitor between this pin and VSS is required.</p> <p>To reduce supply ripple, a larger capacitor of approximately 1000 times the total LCD segment capacitance may be used.</p> <p>If using the LCD with the internal supply source, this pin may be left unconnected or used as a GPIO.</p>
LCD_COM0	0: PE4		LCD driver common line number 0.
LCD_COM1	0: PE5		LCD driver common line number 1.
LCD_COM2	0: PE6		LCD driver common line number 2.
LCD_COM3	0: PE7		LCD driver common line number 3.
LCD_SEG0	0: PF2		LCD segment line 0.
LCD_SEG1	0: PF3		LCD segment line 1.
LCD_SEG2	0: PF4		LCD segment line 2.
LCD_SEG3	0: PF5		LCD segment line 3.
LCD_SEG4	0: PE8		LCD segment line 4.
LCD_SEG5	0: PE9		LCD segment line 5.
LCD_SEG6	0: PE10		LCD segment line 6.

Alternate	LOCATION		Description
	0 - 3	4 - 7	
LCD_SEG7	0: PE11		LCD segment line 7.
LCD_SEG8	0: PE12		LCD segment line 8.
LCD_SEG9	0: PE13		LCD segment line 9.
LCD_SEG10	0: PE14		LCD segment line 10.
LCD_SEG11	0: PE15		LCD segment line 11.
LCD_SEG12	0: PA15		LCD segment line 12.
LCD_SEG13	0: PA0		LCD segment line 13.
LCD_SEG14	0: PA1		LCD segment line 14.
LCD_SEG15	0: PA2		LCD segment line 15.
LCD_SEG16	0: PA3		LCD segment line 16.
LCD_SEG17	0: PA4		LCD segment line 17.
LCD_SEG18	0: PA5		LCD segment line 18.
LCD_SEG19	0: PA6		LCD segment line 19.

Alternate	LOCATION		Description
	0 - 3	4 - 7	
LCD_SEG20 / LCD_COM4	0: PB3		LCD segment line 20. This pin may also be used as LCD COM line 4
LCD_SEG21 / LCD_COM5	0: PB4		LCD segment line 21. This pin may also be used as LCD COM line 5
LCD_SEG22 / LCD_COM6	0: PB5		LCD segment line 22. This pin may also be used as LCD COM line 6
LCD_SEG23 / LCD_COM7	0: PB6		LCD segment line 23. This pin may also be used as LCD COM line 7
LCD_SEG24	0: PF6		LCD segment line 24.
LCD_SEG25	0: PF7		LCD segment line 25.
LCD_SEG26	0: PF8		LCD segment line 26.
LCD_SEG27	0: PF9		LCD segment line 27.
LCD_SEG28	0: PD9		LCD segment line 28.
LCD_SEG29	0: PD10		LCD segment line 29.
LCD_SEG30	0: PD11		LCD segment line 30.
LCD_SEG31	0: PD12		LCD segment line 31.
LCD_SEG32	0: PB0		LCD segment line 32.

Alternate	LOCATION		Description
	0 - 3	4 - 7	
LCD_SEG33	0: PB1		LCD segment line 33.
LCD_SEG34	0: PB2		LCD segment line 34.
LCD_SEG35	0: PA7		LCD segment line 35.
LCD_SEG36	0: PA8		LCD segment line 36.
LCD_SEG37	0: PA9		LCD segment line 37.
LCD_SEG38	0: PA10		LCD segment line 38.
LCD_SEG39	0: PA11		LCD segment line 39.
LES_ALTEX0	0: PD6		LESENSE alternate excite output 0.
LES_ALTEX1	0: PD7		LESENSE alternate excite output 1.
LES_ALTEX2	0: PA3		LESENSE alternate excite output 2.
LES_ALTEX3	0: PA4		LESENSE alternate excite output 3.
LES_ALTEX4	0: PA5		LESENSE alternate excite output 4.
LES_ALTEX5	0: PE11		LESENSE alternate excite output 5.

Alternate	LOCATION		Description
	0 - 3	4 - 7	
LES_ALTEX6	0: PE12		LESENSE alternate excite output 6.
LES_ALTEX7	0: PE13		LESENSE alternate excite output 7.
LES_CH0	0: PC0		LESENSE channel 0.
LES_CH1	0: PC1		LESENSE channel 1.
LES_CH2	0: PC2		LESENSE channel 2.
LES_CH3	0: PC3		LESENSE channel 3.
LES_CH4	0: PC4		LESENSE channel 4.
LES_CH5	0: PC5		LESENSE channel 5.
LES_CH6	0: PC6		LESENSE channel 6.
LES_CH7	0: PC7		LESENSE channel 7.
LES_CH8	0: PC8		LESENSE channel 8.
LES_CH9	0: PC9		LESENSE channel 9.
LES_CH10	0: PC10		LESENSE channel 10.

Alternate	LOCATION		Description
	0 - 3	4 - 7	
LES_CH11	0: PC11		LESENSE channel 11.
LES_CH12	0: PC12		LESENSE channel 12.
LES_CH13	0: PC13		LESENSE channel 13.
LES_CH14	0: PC14		LESENSE channel 14.
LES_CH15	0: PC15		LESENSE channel 15.
LETIM0_OUT0	0: PD6 1: PB11 2: PF0 3: PC4	4: PE12 5: PC14 6: PA8 7: PB9	Low Energy Timer LETIM0, output channel 0.
LETIM0_OUT1	0: PD7 1: PB12 2: PF1 3: PC5	4: PE13 5: PC15 6: PA9 7: PB10	Low Energy Timer LETIM0, output channel 1.
LETIM1_OUT0	0: PA7 1: PA11 2: PA12 3: PC2	4: PB5 5: PB2 6: PG0 7: PG2	Low Energy Timer LETIM1, output channel 0.
LETIM1_OUT1	0: PA6 1: PA13 2: PA14 3: PC3	4: PB6 5: PB1 6: PG1 7: PG3	Low Energy Timer LETIM1, output channel 1.
LEU0_RX	0: PD5 1: PB14 2: PE15 3: PF1	4: PA0 5: PC15	LEUART0 Receive input.
LEU0_TX	0: PD4 1: PB13 2: PE14 3: PF0	4: PF2 5: PC14	LEUART0 Transmit output. Also used as receive input in half duplex communication.
LEU1_RX	0: PC7 1: PA6 2: PD3 3: PB1	4: PB5 5: PH1	LEUART1 Receive input.
LEU1_TX	0: PC6 1: PA5 2: PD2 3: PB0	4: PB4 5: PH0	LEUART1 Transmit output. Also used as receive input in half duplex communication.

Alternate	LOCATION		Description
	0 - 3	4 - 7	
LFXTAL_N	0: PB8		Low Frequency Crystal (typically 32.768 kHz) negative pin. Also used as an optional external clock input pin.
LFXTAL_P	0: PB7		Low Frequency Crystal (typically 32.768 kHz) positive pin.
OPA0_N	0: PC5		Operational Amplifier 0 external negative input.
OPA0_P	0: PC4		Operational Amplifier 0 external positive input.
OPA1_N	0: PD7		Operational Amplifier 1 external negative input.
OPA1_P	0: PD6		Operational Amplifier 1 external positive input.
OPA2_N	0: PD3		Operational Amplifier 2 external negative input.
OPA2_OUT	0: PD5		Operational Amplifier 2 output.
OPA2_OUTALT	0: PD0		Operational Amplifier 2 alternative output.
OPA2_P	0: PD4		Operational Amplifier 2 external positive input.
OPA3_N	0: PC7		Operational Amplifier 3 external negative input.
OPA3_OUT	0: PD1		Operational Amplifier 3 output.
OPA3_P	0: PC6		Operational Amplifier 3 external positive input.

Alternate	LOCATION		Description
	0 - 3	4 - 7	
PCNT0_S0IN	0: PC13 1: PE0 2: PC0 3: PD6	4: PA0 5: PB0 6: PB5 7: PB12	Pulse Counter PCNT0 input number 0.
PCNT0_S1IN	0: PC14 1: PE1 2: PC1 3: PD7	4: PA1 5: PB1 6: PB6 7: PB11	Pulse Counter PCNT0 input number 1.
PCNT1_S0IN	0: PA5 1: PB3 2: PD15 3: PC4	4: PA7 5: PA12 6: PB11 7: PG14	Pulse Counter PCNT1 input number 0.
PCNT1_S1IN	0: PA6 1: PB4 2: PB0 3: PC5	4: PA8 5: PA13 6: PB12 7: PG15	Pulse Counter PCNT1 input number 1.
PCNT2_S0IN	0: PD0 1: PE8 2: PB13 3: PF10	4: PC12 5: PI2 6: PI0 7: PH14	Pulse Counter PCNT2 input number 0.
PCNT2_S1IN	0: PD1 1: PE9 2: PB14 3: PF11	4: PC13 5: PI1 6: PH15 7: PH13	Pulse Counter PCNT2 input number 1.
PRS_CH0	0: PA0 1: PF3 2: PC14 3: PF2		Peripheral Reflex System PRS, channel 0.
PRS_CH1	0: PA1 1: PF4 2: PC15 3: PE12		Peripheral Reflex System PRS, channel 1.
PRS_CH2	0: PC0 1: PF5 2: PE10 3: PE13		Peripheral Reflex System PRS, channel 2.
PRS_CH3	0: PC1 1: PE8 2: PE11 3: PA0		Peripheral Reflex System PRS, channel 3.
PRS_CH4	0: PC8 1: PB0 2: PF1		Peripheral Reflex System PRS, channel 4.
PRS_CH5	0: PC9 1: PB1 2: PD6		Peripheral Reflex System PRS, channel 5.
PRS_CH6	0: PA6 1: PB14 2: PE6		Peripheral Reflex System PRS, channel 6.

Alternate	LOCATION		Description
	0 - 3	4 - 7	
PRS_CH7	0: PB13 1: PA7 2: PE7		Peripheral Reflex System PRS, channel 7.
PRS_CH8	0: PA8 1: PA2 2: PE9		Peripheral Reflex System PRS, channel 8.
PRS_CH9	0: PA9 1: PA3 2: PB10		Peripheral Reflex System PRS, channel 9.
PRS_CH10	0: PA10 1: PC2 2: PD4		Peripheral Reflex System PRS, channel 10.
PRS_CH11	0: PA11 1: PC3 2: PD5		Peripheral Reflex System PRS, channel 11.
PRS_CH12	0: PA12 1: PB6 2: PD8		Peripheral Reflex System PRS, channel 12.
PRS_CH13	0: PA13 1: PB9 2: PE14		Peripheral Reflex System PRS, channel 13.
PRS_CH14	0: PA14 1: PC6 2: PE15		Peripheral Reflex System PRS, channel 14.
PRS_CH15	0: PA15 1: PC7 2: PF0		Peripheral Reflex System PRS, channel 15.
PRS_CH16	0: PA4 1: PB12 2: PE4		Peripheral Reflex System PRS, channel 16.
PRS_CH17	0: PA5 1: PB15 2: PE5		Peripheral Reflex System PRS, channel 17.
PRS_CH18	0: PB2 1: PC10 2: PC4		Peripheral Reflex System PRS, channel 18.
PRS_CH19	0: PB3 1: PC11 2: PC5		Peripheral Reflex System PRS, channel 19.

Alternate	LOCATION		Description
	0 - 3	4 - 7	
PRS_CH20	0: PB4 1: PC12 2: PE2		Peripheral Reflex System PRS, channel 20.
PRS_CH21	0: PB5 1: PC13 2: PB11		Peripheral Reflex System PRS, channel 21.
PRS_CH22	0: PB7 1: PE0 2: PF6		Peripheral Reflex System PRS, channel 22.
PRS_CH23	0: PB8 1: PE1 2: PF7		Peripheral Reflex System PRS, channel 23.
QSPI0_CS0	0: PF7 1: PA0 2: PG9		Quad SPI 0 Chip Select 0.
QSPI0_CS1	0: PF8 1: PA1 2: PG10		Quad SPI 0 Chip Select 1.
QSPI0_DQ0	0: PD9 1: PA2 2: PG1		Quad SPI 0 Data 0.
QSPI0_DQ1	0: PD10 1: PA3 2: PG2		Quad SPI 0 Data 1.
QSPI0_DQ2	0: PD11 1: PA4 2: PG3		Quad SPI 0 Data 2.
QSPI0_DQ3	0: PD12 1: PA5 2: PG4		Quad SPI 0 Data 3.
QSPI0_DQ4	0: PE8 1: PB3 2: PG5		Quad SPI 0 Data 4.
QSPI0_DQ5	0: PE9 1: PB4 2: PG6		Quad SPI 0 Data 5.
QSPI0_DQ6	0: PE10 1: PB5 2: PG7		Quad SPI 0 Data 6.

Alternate	LOCATION		Description
	0 - 3	4 - 7	
QSPI0_DQ7	0: PE11 1: PB6 2: PG8		Quad SPI 0 Data 7.
QSPI0_DQS	0: PF9 1: PE15 2: PG11		Quad SPI 0 Data S.
QSPI0_SCLK	0: PF6 1: PE14 2: PG0		Quad SPI 0 Serial Clock.
SDIO_CD	0: PF8 1: PC4 2: PA6 3: PB10		SDIO Card Detect.
SDIO_CLK	0: PE13 1: PE14		SDIO Serial Clock.
SDIO_CMD	0: PE12 1: PE15		SDIO Command.
SDIO_DAT0	0: PE11 1: PA0		SDIO Data 0.
SDIO_DAT1	0: PE10 1: PA1		SDIO Data 1.
SDIO_DAT2	0: PE9 1: PA2		SDIO Data 2.
SDIO_DAT3	0: PE8 1: PA3		SDIO Data 3.
SDIO_DAT4	0: PD12 1: PA4		SDIO Data 4.
SDIO_DAT5	0: PD11 1: PA5		SDIO Data 5.
SDIO_DAT6	0: PD10 1: PB3		SDIO Data 6.

Alternate	LOCATION		
Functionality	0 - 3	4 - 7	Description
SDIO_DAT7	0: PD9 1: PB4		SDIO Data 7.
SDIO_WP	0: PF9 1: PC5 2: PB15 3: PB9		SDIO Write Protect.
TIM0_CC0	0: PA0 1: PF6 2: PD1 3: PB6	4: PF0 5: PC4 6: PA8 7: PA1	Timer 0 Capture Compare input / output channel 0.
TIM0_CC1	0: PA1 1: PF7 2: PD2 3: PC0	4: PF1 5: PC5 6: PA9 7: PA0	Timer 0 Capture Compare input / output channel 1.
TIM0_CC2	0: PA2 1: PF8 2: PD3 3: PC1	4: PF2 5: PA7 6: PA10 7: PA13	Timer 0 Capture Compare input / output channel 2.
TIM0_CDT10	0: PA3 1: PC13 2: PF3 3: PC2	4: PB7	Timer 0 Complimentary Dead Time Insertion channel 0.
TIM0_CDT11	0: PA4 1: PC14 2: PF4 3: PC3	4: PB8	Timer 0 Complimentary Dead Time Insertion channel 1.
TIM0_CDT12	0: PA5 1: PC15 2: PF5 3: PC4	4: PB11	Timer 0 Complimentary Dead Time Insertion channel 2.
TIM1_CC0	0: PC13 1: PE10 2: PB0 3: PB7	4: PD6 5: PF2 6: PF13 7: PI6	Timer 1 Capture Compare input / output channel 0.
TIM1_CC1	0: PC14 1: PE11 2: PB1 3: PB8	4: PD7 5: PF3 6: PF14 7: PI7	Timer 1 Capture Compare input / output channel 1.
TIM1_CC2	0: PC15 1: PE12 2: PB2 3: PB11	4: PC13 5: PF4 6: PF15 7: PI8	Timer 1 Capture Compare input / output channel 2.
TIM1_CC3	0: PC12 1: PE13 2: PB3 3: PB12	4: PC14 5: PF12 6: PF5 7: PI9	Timer 1 Capture Compare input / output channel 3.
TIM2_CC0	0: PA8 1: PA12 2: PC8 3: PF2	4: PB6 5: PC2 6: PG8 7: PG5	Timer 2 Capture Compare input / output channel 0.

Alternate	LOCATION		Description
	0 - 3	4 - 7	
TIM2_CC1	0: PA9 1: PA13 2: PC9 3: PE12	4: PC0 5: PC3 6: PG9 7: PG6	Timer 2 Capture Compare input / output channel 1.
TIM2_CC2	0: PA10 1: PA14 2: PC10 3: PE13	4: PC1 5: PC4 6: PG10 7: PG7	Timer 2 Capture Compare input / output channel 2.
TIM2_CDT10	0: PB0 1: PD13 2: PE8 3: PG0		Timer 2 Complimentary Dead Time Insertion channel 0.
TIM2_CDT11	0: PB1 1: PD14 2: PE14 3: PG1		Timer 2 Complimentary Dead Time Insertion channel 1.
TIM2_CDT12	0: PB2 1: PD15 2: PE15 3: PG2		Timer 2 Complimentary Dead Time Insertion channel 2.
TIM3_CC0	0: PE14 1: PE0 2: PE3 3: PE5	4: PA0 5: PA3 6: PA6 7: PD15	Timer 3 Capture Compare input / output channel 0.
TIM3_CC1	0: PE15 1: PE1 2: PE4 3: PE6	4: PA1 5: PA4 6: PD13 7: PB15	Timer 3 Capture Compare input / output channel 1.
TIM3_CC2	0: PA15 1: PE2 2: PE5 3: PE7	4: PA2 5: PA5 6: PD14 7: PB0	Timer 3 Capture Compare input / output channel 2.
TIM4_CC0	0: PF3 1: PF13 2: PF5 3: PI8	4: PF6 5: PF9 6: PD11 7: PE9	Timer 4 Capture Compare input / output channel 0.
TIM4_CC1	0: PF4 1: PF14 2: PI6 3: PI9	4: PF7 5: PD9 6: PD12 7: PE10	Timer 4 Capture Compare input / output channel 1.
TIM4_CC2	0: PF12 1: PF15 2: PI7 3: PI10	4: PF8 5: PD10 6: PE8 7: PE11	Timer 4 Capture Compare input / output channel 2.
TIM4_CDT10	0: PD0		Timer 4 Complimentary Dead Time Insertion channel 0.
TIM4_CDT11	0: PD1		Timer 4 Complimentary Dead Time Insertion channel 1.

Alternate	LOCATION		
Functionality	0 - 3	4 - 7	Description
TIM4_CDT12	0: PD3		Timer 4 Complimentary Dead Time Insertion channel 2.
TIM5_CC0	0: PE4 1: PE7 2: PH13 3: PI0	4: PC8 5: PC11 6: PC14 7: PF12	Timer 5 Capture Compare input / output channel 0.
TIM5_CC1	0: PE5 1: PH11 2: PH14 3: PI1	4: PC9 5: PC12 6: PF10 7: PF13	Timer 5 Capture Compare input / output channel 1.
TIM5_CC2	0: PE6 1: PH12 2: PH15 3: PI2	4: PC10 5: PC13 6: PF11 7: PF14	Timer 5 Capture Compare input / output channel 2.
TIM6_CC0	0: PG0 1: PG6 2: PG12 3: PH2	4: PH8 5: PB13 6: PD1 7: PD4	Timer 6 Capture Compare input / output channel 0.
TIM6_CC1	0: PG1 1: PG7 2: PG13 3: PH3	4: PH9 5: PB14 6: PD2 7: PD5	Timer 6 Capture Compare input / output channel 1.
TIM6_CC2	0: PG2 1: PG8 2: PG14 3: PH4	4: PH10 5: PD0 6: PD3 7: PD6	Timer 6 Capture Compare input / output channel 2.
TIM6_CDT10	0: PG3 1: PG9 2: PE4 3: PH5		Timer 6 Complimentary Dead Time Insertion channel 0.
TIM6_CDT11	0: PG4 1: PG10 2: PE5 3: PH6		Timer 6 Complimentary Dead Time Insertion channel 1.
TIM6_CDT12	0: PG5 1: PG11 2: PE6 3: PH7		Timer 6 Complimentary Dead Time Insertion channel 2.
U0_CTS	0: PF8 1: PE2 2: PA5 3: PC13	4: PB7 5: PD5	UART0 Clear To Send hardware flow control input.
U0_RTS	0: PF9 1: PE3 2: PA6 3: PC12	4: PB8 5: PD6	UART0 Request To Send hardware flow control output.
U0_RX	0: PF7 1: PE1 2: PA4 3: PC15	4: PC5 5: PF2 6: PE4	UART0 Receive input.

Alternate	LOCATION		
Functionality	0 - 3	4 - 7	Description
U0_TX	0: PF6 1: PE0 2: PA3 3: PC14	4: PC4 5: PF1 6: PD7	UART0 Transmit output. Also used as receive input in half duplex communication.
U1_CTS	0: PC14 1: PF9 2: PB11 3: PE4	4: PC4 5: PH13	UART1 Clear To Send hardware flow control input.
U1_RTS	0: PC15 1: PF8 2: PB12 3: PE5	4: PC5 5: PH14	UART1 Request To Send hardware flow control output.
U1_RX	0: PC13 1: PF11 2: PB10 3: PE3	4: PE13 5: PH12	UART1 Receive input.
U1_TX	0: PC12 1: PF10 2: PB9 3: PE2	4: PE12 5: PH11	UART1 Transmit output. Also used as receive input in half duplex communication.
US0_CLK	0: PE12 1: PE5 2: PC9 3: PC15	4: PB13 5: PA12 6: PG14	USART0 clock input / output.
US0_CS	0: PE13 1: PE4 2: PC8 3: PC14	4: PB14 5: PA13 6: PG15	USART0 chip select input / output.
US0_CTS	0: PE14 1: PE3 2: PC7 3: PC13	4: PB6 5: PB11 6: PH0	USART0 Clear To Send hardware flow control input.
US0_RTS	0: PE15 1: PE2 2: PC6 3: PC12	4: PB5 5: PD6 6: PH1	USART0 Request To Send hardware flow control output.
US0_RX	0: PE11 1: PE6 2: PC10 3: PE12	4: PB8 5: PC1 6: PG13	USART0 Asynchronous Receive. USART0 Synchronous mode Master Input / Slave Output (MISO).
US0_TX	0: PE10 1: PE7 2: PC11 3: PE13	4: PB7 5: PC0 6: PG12	USART0 Asynchronous Transmit. Also used as receive input in half duplex communication. USART0 Synchronous mode Master Output / Slave Input (MOSI).
US1_CLK	0: PB7 1: PD2 2: PF0 3: PC15	4: PC3 5: PB11 6: PE5	USART1 clock input / output.
US1_CS	0: PB8 1: PD3 2: PF1 3: PC14	4: PC0 5: PE4 6: PB2	USART1 chip select input / output.

Alternate	LOCATION		
Functionality	0 - 3	4 - 7	Description
US1_CTS	0: PB9 1: PD4 2: PF3 3: PC6	4: PC12 5: PB13 6: PH2	USART1 Clear To Send hardware flow control input.
US1_RTS	0: PB10 1: PD5 2: PF4 3: PC7	4: PC13 5: PB14 6: PH3	USART1 Request To Send hardware flow control output.
US1_RX	0: PC1 1: PD1 2: PD6 3: PF7	4: PC2 5: PA0 6: PA2	USART1 Asynchronous Receive. USART1 Synchronous mode Master Input / Slave Output (MISO).
US1_TX	0: PC0 1: PD0 2: PD7 3: PF6	4: PC1 5: PF2 6: PA14	USART1 Asynchronous Transmit. Also used as receive input in half duplex communication. USART1 Synchronous mode Master Output / Slave Input (MOSI).
US2_CLK	0: PC4 1: PB5 2: PA9 3: PA15	4: PF8 5: PF2	USART2 clock input / output.
US2_CS	0: PC5 1: PB6 2: PA10 3: PB11	4: PF9 5: PF5	USART2 chip select input / output.
US2_CTS	0: PC1 1: PB12 2: PA11 3: PB10	4: PC12 5: PD6	USART2 Clear To Send hardware flow control input.
US2_RTS	0: PC0 1: PB15 2: PA12 3: PC14	4: PC13 5: PD8	USART2 Request To Send hardware flow control output.
US2_RX	0: PC3 1: PB4 2: PA8 3: PA14	4: PF7 5: PF1	USART2 Asynchronous Receive. USART2 Synchronous mode Master Input / Slave Output (MISO).
US2_TX	0: PC2 1: PB3 2: PA7 3: PA13	4: PF6 5: PF0	USART2 Asynchronous Transmit. Also used as receive input in half duplex communication. USART2 Synchronous mode Master Output / Slave Input (MOSI).
US3_CLK	0: PA2 1: PD7 2: PD4 3: PG8	4: PG2 5: PI14	USART3 clock input / output.
US3_CS	0: PA3 1: PE4 2: PC14 3: PC0	4: PG3 5: PI15	USART3 chip select input / output.
US3_CTS	0: PA4 1: PE5 2: PD6 3: PG10	4: PG4 5: PG9	USART3 Clear To Send hardware flow control input.

Alternate	LOCATION		
Functionality	0 - 3	4 - 7	Description
US3_RTS	0: PA5 1: PC1 2: PA14 3: PC15	4: PG5 5: PG11	USART3 Request To Send hardware flow control output.
US3_RX	0: PA1 1: PE7 2: PB7 3: PG7	4: PG1 5: PI13	USART3 Asynchronous Receive. USART3 Synchronous mode Master Input / Slave Output (MISO).
US3_TX	0: PA0 1: PE6 2: PB3 3: PG6	4: PG0 5: PI12	USART3 Asynchronous Transmit. Also used as receive input in half duplex communication. USART3 Synchronous mode Master Output / Slave Input (MOSI).
US4_CLK	0: PC4 1: PD11 2: PI2 3: PI8	4: PH6	USART4 clock input / output.
US4_CS	0: PC5 1: PD12 2: PI3 3: PI9	4: PH7	USART4 chip select input / output.
US4_CTS	0: PA7 1: PD13 2: PI4 3: PI10	4: PH8	USART4 Clear To Send hardware flow control input.
US4_RTS	0: PA8 1: PD14 2: PI5 3: PI11	4: PH9	USART4 Request To Send hardware flow control output.
US4_RX	0: PB8 1: PD10 2: PI1 3: PI7	4: PH5	USART4 Asynchronous Receive. USART4 Synchronous mode Master Input / Slave Output (MISO).
US4_TX	0: PB7 1: PD9 2: PI0 3: PI6	4: PH4	USART4 Asynchronous Transmit. Also used as receive input in half duplex communication. USART4 Synchronous mode Master Output / Slave Input (MOSI).
US5_CLK	0: PB11 1: PD13 2: PF13 3: PH12		USART5 clock input / output.
US5_CS	0: PB13 1: PD14 2: PF12 3: PH13		USART5 chip select input / output.
US5_CTS	0: PB14 1: PD15 2: PF11 3: PH14		USART5 Clear To Send hardware flow control input.
US5_RTS	0: PB12 1: PB15 2: PF10 3: PH15		USART5 Request To Send hardware flow control output.

Alternate	LOCATION		Description
	0 - 3	4 - 7	
US5_RX	0: PE9 1: PA7 2: PB1 3: PH11		USART5 Asynchronous Receive. USART5 Synchronous mode Master Input / Slave Output (MISO).
US5_TX	0: PE8 1: PA6 2: PF15 3: PH10		USART5 Asynchronous Transmit. Also used as receive input in half duplex communication. USART5 Synchronous mode Master Output / Slave Input (MOSI).
USB_DM	0: PF10		USB D- pin.
USB_DP	0: PF11		USB D+ pin.
USB_ID	0: PF12		USB ID pin.
USB_VBUSEN	0: PF5		USB 5 V VBUS enable.
VDAC0_EXT	0: PD6		Digital to analog converter VDACC0 external reference input pin.
VDACC0_OUT0 / OPA0_OUT	0: PB11		Digital to Analog Converter DAC0 output channel number 0.
VDACC0_OUT0ALT / OPA0_OUTALT	0: PC0 1: PC1 2: PC2 3: PC3	4: PD0	Digital to Analog Converter DAC0 alternative output for channel 0.
VDACC0_OUT1 / OPA1_OUT	0: PB12		Digital to Analog Converter DAC0 output channel number 1.
VDACC0_OUT1ALT / OPA1_OUTALT	0: PC12 1: PC13 2: PC14 3: PC15	4: PD1	Digital to Analog Converter DAC0 alternative output for channel 1.
WTIM0_CC0	0: PE4 1: PA6 2: PG2 3: PG8	4: PC15 5: PB0 6: PB3 7: PC1	Wide timer 0 Capture Compare input / output channel 0.
WTIM0_CC1	0: PE5 1: PD13 2: PG3 3: PG9	4: PF0 5: PB1 6: PB4 7: PC2	Wide timer 0 Capture Compare input / output channel 1.

Alternate	LOCATION		
Functionality	0 - 3	4 - 7	Description
WTIM0_CC2	0: PE6 1: PD14 2: PG4 3: PG10	4: PF1 5: PB2 6: PB5 7: PC3	Wide timer 0 Capture Compare input / output channel 2.
WTIM0_CDTI0	0: PE10 1: PD15 2: PA12 3: PG11	4: PD4	Wide timer 0 Complimentary Dead Time Insertion channel 0.
WTIM0_CDTI1	0: PE11 1: PG0 2: PA13 3: PG12	4: PD5	Wide timer 0 Complimentary Dead Time Insertion channel 1.
WTIM0_CDTI2	0: PE12 1: PG1 2: PA14 3: PG13	4: PD6	Wide timer 0 Complimentary Dead Time Insertion channel 2.
WTIM1_CC0	0: PB13 1: PD2 2: PD6 3: PC7	4: PE3 5: PE7 6: PH8 7: PH12	Wide timer 1 Capture Compare input / output channel 0.
WTIM1_CC1	0: PB14 1: PD3 2: PD7 3: PE0	4: PE4 5: PI0 6: PH9 7: PH13	Wide timer 1 Capture Compare input / output channel 1.
WTIM1_CC2	0: PD0 1: PD4 2: PD8 3: PE1	4: PE5 5: PI1 6: PH10 7: PH14	Wide timer 1 Capture Compare input / output channel 2.
WTIM1_CC3	0: PD1 1: PD5 2: PC6 3: PE2	4: PE6 5: PI2 6: PH11 7: PH15	Wide timer 1 Capture Compare input / output channel 3.
WTIM2_CC0	0: PA9 1: PA12 2: PB9 3: PB12	4: PG14 5: PD3 6: PH4 7: PH7	Wide timer 2 Capture Compare input / output channel 0.
WTIM2_CC1	0: PA10 1: PA13 2: PB10 3: PG12	4: PG15 5: PD4 6: PH5 7: PH8	Wide timer 2 Capture Compare input / output channel 1.
WTIM2_CC2	0: PA11 1: PA14 2: PB11 3: PG13	4: PH0 5: PD5 6: PH6 7: PH9	Wide timer 2 Capture Compare input / output channel 2.
WTIM3_CC0	0: PD9 1: PC8 2: PC11 3: PC14	4: PI3 5: PI6 6: PB6 7: PF13	Wide timer 3 Capture Compare input / output channel 0.
WTIM3_CC1	0: PD10 1: PC9 2: PC12 3: PF10	4: PI4 5: PI7 6: PF4 7: PF14	Wide timer 3 Capture Compare input / output channel 1.

Alternate	LOCATION		
Functionality	0 - 3	4 - 7	Description
WTIM3_CC2	0: PD11 1: PC10 2: PC13 3: PF11	4: PI5 5: PF6 6: PF12 7: PF15	Wide timer 3 Capture Compare input / output channel 2.

Certain alternate function locations may have non-interference priority. These locations will take precedence over any other functions selected on that pin (i.e. another alternate function enabled to the same pin inadvertently).

Some alternate functions may also have high speed priority on certain locations. These locations ensure the fastest possible paths to the pins for timing-critical signals.

The following table lists the alternate functions and locations with special priority.

Table 5.22. Alternate Functionality Priority

Alternate Functionality	Location	Priority
CMU_CLK2	1: PA3 5: PD10	High Speed High Speed
CMU_CLKI0	1: PA3 5: PD10	High Speed High Speed
ETH_RMIICRSVDV	0: PA4 1: PD11	High Speed High Speed
ETH_RMIIREFCLK	0: PA3 1: PD10	High Speed High Speed
ETH_RMIIRXD0	0: PA2 1: PD9	High Speed High Speed
ETH_RMIIRXD1	0: PA1 1: PF9	High Speed High Speed
ETH_RMIIRXER	0: PA5 1: PD12	High Speed High Speed
ETH_RMIITXD0	0: PE15 1: PF7	High Speed High Speed
ETH_RMIITXD1	0: PE14 1: PF6	High Speed High Speed
ETH_RMIITXEN	0: PA0 1: PF8	High Speed High Speed
QSPI0_CS0	0: PF7	High Speed
QSPI0_CS1	0: PF8	High Speed
QSPI0_DQ0	0: PD9	High Speed
QSPI0_DQ1	0: PD10	High Speed
QSPI0_DQ2	0: PD11	High Speed
QSPI0_DQ3	0: PD12	High Speed
QSPI0_DQ4	0: PE8	High Speed
QSPI0_DQ5	0: PE9	High Speed
QSPI0_DQ6	0: PE10	High Speed
QSPI0_DQ7	0: PE11	High Speed

Alternate Functionality	Location	Priority
QSPI0_DQS	0: PF9	High Speed
QSPI0_SCLK	0: PF6	High Speed
SDIO_CLK	0: PE13	High Speed
SDIO_CMD	0: PE12	High Speed
SDIO_DAT0	0: PE11	High Speed
SDIO_DAT1	0: PE10	High Speed
SDIO_DAT2	0: PE9	High Speed
SDIO_DAT3	0: PE8	High Speed
SDIO_DAT4	0: PD12	High Speed
SDIO_DAT5	0: PD11	High Speed
SDIO_DAT6	0: PD10	High Speed
SDIO_DAT7	0: PD9	High Speed
TIM0_CC0	3: PB6	Non-interference
TIM0_CC1	3: PC0	Non-interference
TIM0_CC2	3: PC1	Non-interference
TIM0_CDT10	1: PC13	Non-interference
TIM0_CDT11	1: PC14	Non-interference
TIM0_CDT12	1: PC15	Non-interference
TIM2_CC0	0: PA8	Non-interference
TIM2_CC1	0: PA9	Non-interference
TIM2_CC2	0: PA10	Non-interference
TIM2_CDT10	0: PB0	Non-interference
TIM2_CDT11	0: PB1	Non-interference
TIM2_CDT12	0: PB2	Non-interference
TIM4_CC0	0: PF3	Non-interference
TIM4_CC1	0: PF4	Non-interference
TIM4_CC2	0: PF12	Non-interference
TIM4_CDT10	0: PD0	Non-interference
TIM4_CDT11	0: PD1	Non-interference
TIM4_CDT12	0: PD3	Non-interference
TIM6_CC0	0: PG0	Non-interference
TIM6_CC1	0: PG1	Non-interference
TIM6_CC2	0: PG2	Non-interference
TIM6_CDT10	0: PG3	Non-interference
TIM6_CDT11	0: PG4	Non-interference
TIM6_CDT12	0: PG5	Non-interference

Alternate Functionality	Location	Priority
US2_CLK	4: PF8 5: PF2	High Speed High Speed
US2_CS	4: PF9 5: PF5	High Speed High Speed
US2_RX	4: PF7 5: PF1	High Speed High Speed
US2_TX	4: PF6 5: PF0	High Speed High Speed

5.22 Analog Port (APORT) Client Maps

The Analog Port (APORT) is an infrastructure used to connect chip pins with on-chip analog clients such as analog comparators, ADCs, DACs, etc. The APORT consists of a set of shared buses, switches, and control logic needed to configurably implement the signal routing. Figure 5.20 APORT Connection Diagram on page 214 shows the APORT routing for this device family (note that available features may vary by part number). A complete description of APORT functionality can be found in the Reference Manual.



Figure 5.20. APORT Connection Diagram

Client maps for each analog circuit using the APORT are shown in the following tables. The maps are organized by bus, and show the peripheral's port connection, the shared bus, and the connection from specific bus channel numbers to GPIO pins.

In general, enumerations for the pin selection field in an analog peripheral's register can be determined by finding the desired pin connection in the table and then combining the value in the Port column (APORT__), and the channel identifier (CH__). For example, if pin PF7 is available on port APORT2X as CH23, the register field enumeration to connect to PF7 would be APORT2XCH23. The shared bus used by this connection is indicated in the Bus column.

Table 5.23. ACMP0 Bus and Pin Mapping

APORT4Y	APORT4X	APORT3Y	APORT3X	APORT2Y	APORT2X	APORT1Y	APORT1X	APORT0Y	APORT0X	Port
BUSDY	BUSDX	BUSCY	BUSCX	BUSBY	BUSBX	BUSAY	BUSAX	BUSACMP0Y	BUSACMP0X	Bus
PF14	PF15	PF15	PF14	PB14	PB15	PB15	PB14			CH31
										CH30
	PF13	PF13		PB14	PB13	PB13	PB14			CH29
PF12			PF12	PB12			PB12			CH28
	PF11	PF11			PB11	PB11				CH27
PF10			PF10	PB10			PB10			CH26
	PF9	PF9			PB9	PB9				CH25
PF8			PF8							CH24
	PF7	PF7								CH23
PF6			PF6	PB6			PB6			CH22
	PF5	PF5			PB5	PB5				CH21
PF4			PF4	PB4			PB4			CH20
	PF3	PF3			PB3	PB3				CH19
PF2			PF2	PB2			PB2			CH18
	PF1	PF1			PB1	PB1				CH17
PF0			PF0	PB0			PB0			CH16
	PE15	PE15			PA15	PA15				CH15
PE14			PE14	PA14			PA14			CH14
	PE13	PE13			PA13	PA13				CH13
PE12			PE12	PA12			PA12			CH12
	PE11	PE11			PA11	PA11				CH11
PE10			PE10	PA10			PA10			CH10
	PE9	PE9			PA9	PA9				CH9
PE8			PE8	PA8			PA8			CH8
	PE7	PE7			PA7	PA7		PC7	PC7	CH7
PE6			PE6	PA6			PA6	PC6	PC6	CH6
	PE5	PE5			PA5	PA5		PC5	PC5	CH5
PE4			PE4	PA4			PA4	PC4	PC4	CH4
					PA3	PA3		PC3	PC3	CH3
				PA2			PA2	PC2	PC2	CH2
	PE1	PE1			PA1	PA1		PC1	PC1	CH1
PE0			PE0	PA0			PA0	PC0	PC0	CH0

Table 5.24. ACMP1 Bus and Pin Mapping

APORT4Y	APORT4X	APORT3Y	APORT3X	APORT2Y	APORT2X	APORT1Y	APORT1X	APORT0Y	APORT0X	Port
BUSDY	BUSDX	BUSCY	BUSCX	BUSBY	BUSBX	BUSAY	BUSAX	BUSACMP1Y	BUSACMP1X	Bus
PF14	PF15	PF15	PF14	PB14	PB15	PB15	PB14			CH31
										CH30
	PF13	PF13			PB13	PB13				CH29
PF12			PF12	PB12			PB12			CH28
	PF11	PF11			PB11	PB11				CH27
PF10			PF10	PB10			PB10			CH26
	PF9	PF9			PB9	PB9				CH25
PF8			PF8							CH24
	PF7	PF7								CH23
PF6			PF6	PB6			PB6			CH22
	PF5	PF5			PB5	PB5				CH21
PF4			PF4	PB4			PB4			CH20
	PF3	PF3			PB3	PB3				CH19
PF2			PF2	PB2			PB2			CH18
	PF1	PF1			PB1	PB1				CH17
PF0			PF0	PB0			PB0			CH16
	PE15	PE15			PA15	PA15				CH15
PE14			PE14	PA14			PA14			CH14
	PE13	PE13			PA13	PA13				CH13
PE12			PE12	PA12			PA12			CH12
	PE11	PE11			PA11	PA11				CH11
PE10			PE10	PA10			PA10			CH10
	PE9	PE9			PA9	PA9				CH9
PE8			PE8	PA8			PA8			CH8
	PE7	PE7			PA7	PA7		PC15	PC15	CH7
PE6			PE6	PA6			PA6	PC14	PC14	CH6
	PE5	PE5			PA5	PA5		PC13	PC13	CH5
PE4			PE4	PA4			PA4	PC12	PC12	CH4
					PA3	PA3		PC11	PC11	CH3
				PA2			PA2	PC10	PC10	CH2
	PE1	PE1			PA1	PA1		PC9	PC9	CH1
PE0			PE0	PA0			PA0	PC8	PC8	CH0

Table 5.25. ACMP2 Bus and Pin Mapping

APORT4Y	APORT4X	APORT3Y	APORT3X	APORT2Y	APORT2X	APORT1Y	APORT1X	APORT0Y	APORT0X	Port
BUSDY	BUSDX	BUSCY	BUSCX	BUSBY	BUSBX	BUSAY	BUSAX	BUSACMP2Y	BUSACMP2X	Bus
PF14	PF15	PF15	PF14	PB14	PB15	PB15	PB14			CH31
	PF13	PF13								CH30
PF12	PF11	PF11	PF12	PB12	PB13	PB13	PB12			CH29
	PF10		PF10							CH28
PF10				PB10			PB10			CH27
	PF9	PF9								CH26
PF8			PF8							CH25
	PF7	PF7								CH24
PF6			PF6	PB6			PB6			CH23
	PF5	PF5								CH22
PF4			PF4	PB4	PB5	PB5	PB4			CH21
	PF3	PF3								CH20
PF2			PF2	PB2	PB3	PB3	PB2			CH19
	PF1	PF1								CH18
PF0			PF0	PB0	PB1	PB1	PB0			CH17
	PE15	PE15								CH16
PE14			PE14	PA14	PA15	PA15	PA14			CH15
	PE13	PE13								CH14
PE12			PE12	PA12	PA13	PA13	PA12			CH13
	PE11	PE11								CH12
PE10			PE10	PA10	PA11	PA11	PA10			CH11
	PE9	PE9								CH10
PE8			PE8	PA8	PA9	PA9	PA8			CH9
	PE7	PE7								CH8
PE6			PE6	PA6	PA7	PA7	PA6	PG7	PG7	CH7
	PE5	PE5								CH6
PE4			PE4	PA4	PA5	PA5	PA4	PG5	PG5	CH5
										CH4
										CH3
				PA2			PA2	PG2	PG2	CH2
	PE1	PE1								CH1
PE0			PE0	PA0			PA0	PG0	PG0	CH0

Table 5.26. ACMP3 Bus and Pin Mapping

APORT4Y	APORT4X	APORT3Y	APORT3X	APORT2Y	APORT2X	APORT1Y	APORT1X	APORT0Y	APORT0X	Port
BUSDY	BUSDX	BUSCY	BUSCX	BUSBY	BUSBX	BUSAY	BUSAX	BUSACMP3Y	BUSACMP3X	Bus
PF14	PF15	PF15	PF14	PB14	PB15	PB15	PB14			CH31
	PF13	PF13								CH30
PF12	PF11	PF11	PF12	PB12	PB13	PB13	PB12			CH29
	PF10		PF10	PB10	PB11	PB11	PB10			CH28
PF8	PF9	PF9	PF8		PB9	PB9				CH27
	PF7	PF7								CH26
PF6	PF5	PF5	PF6	PB6	PB5	PB5	PB6			CH25
	PF4		PF4	PB4	PB5	PB5	PB4			CH24
PF2	PF3	PF3	PF2	PB2	PB3	PB3	PB2			CH23
	PF1	PF1			PB1	PB1				CH22
PF0	PF0		PF0	PB0	PB1	PB1	PB0			CH21
	PE15	PE15	PE14	PA14	PA15	PA15	PA14			CH20
PE14	PE13	PE13	PE14	PA12	PA13	PA13	PA12			CH19
	PE11	PE11	PE12	PA10	PA11	PA11	PA10			CH18
PE10	PE9	PE9	PE10	PA8	PA9	PA9	PA8			CH17
	PE7	PE7	PE8	PA6	PA7	PA7	PA6			CH16
PE8	PE5	PE5	PE6	PA4	PA5	PA5	PA4			CH15
	PE3	PE3	PE4	PA2	PA3	PA3	PA2			CH14
PE6	PE1	PE1	PE2	PA0	PA1	PA1	PA0			CH13
	PE15	PE15	PE14	PA12	PA13	PA13	PA12			CH12
PE10	PE11	PE11	PE10	PA10	PA11	PA11	PA10			CH11
	PE9	PE9	PE8	PA8	PA9	PA9	PA8			CH10
PE8	PE7	PE7	PE8	PA6	PA7	PA7	PA6			CH9
	PE5	PE5	PE6	PA4	PA5	PA5	PA4			CH8
PE6	PE5	PE5	PE6	PA2	PA3	PA3	PA2			CH7
PE4	PE4	PE4	PE4	PA0	PA1	PA1	PA0			CH6
	PE1	PE1	PE2	PA0	PA1	PA1	PA0			CH5
	PE1	PE1	PE2	PA0	PA1	PA1	PA0			CH4
PE0	PE0	PE0	PE0	PA0	PA1	PA1	PA0			CH3
	PE1	PE1	PE2	PA0	PA1	PA1	PA0			CH2
PE0	PE0	PE0	PE0	PA0	PA1	PA1	PA0			CH1
	PE0	PE0	PE0	PA0	PA1	PA1	PA0			CH0

Table 5.27. ADC0 Bus and Pin Mapping

APORT4Y	APORT4X	APORT3Y	APORT3X	APORT2Y	APORT2X	APORT1Y	APORT1X	APORT0Y	APORT0X	Port
BUSDY	BUSDX	BUSCY	BUSCX	BUSBY	BUSBX	BUSAY	BUSAX	BUSADC0Y	BUSADC0X	Bus
	PF15	PF15			PB15	PB15				CH31
PF14			PF14	PB14			PB14			CH30
	PF13	PF13			PB13	PB13				CH29
PF12			PF12	PB12			PB12			CH28
	PF11	PF11			PB11	PB11				CH27
PF10			PF10	PB10			PB10			CH26
	PF9	PF9			PB9	PB9				CH25
PF8			PF8							CH24
	PF7	PF7								CH23
PF6			PF6	PB6			PB6			CH22
	PF5	PF5			PB5	PB5				CH21
PF4			PF4	PB4			PB4			CH20
	PF3	PF3			PB3	PB3				CH19
PF2			PF2	PB2			PB2			CH18
	PF1	PF1			PB1	PB1				CH17
PF0			PF0	PB0			PB0			CH16
	PE15	PE15			PA15	PA15				CH15
PE14			PE14	PA14			PA14			CH14
	PE13	PE13			PA13	PA13				CH13
PE12			PE12	PA12			PA12			CH12
	PE11	PE11			PA11	PA11				CH11
PE10			PE10	PA10			PA10			CH10
	PE9	PE9			PA9	PA9				CH9
PE8			PE8	PA8			PA8			CH8
	PE7	PE7			PA7	PA7		PD7	PD7	CH7
PE6			PE6	PA6			PA6	PD6	PD6	CH6
	PE5	PE5			PA5	PA5		PD5	PD5	CH5
PE4			PE4	PA4			PA4	PD4	PD4	CH4
					PA3	PA3		PD3	PD3	CH3
				PA2			PA2	PD2	PD2	CH2
	PE1	PE1			PA1	PA1		PD1	PD1	CH1
PE0			PE0	PA0			PA0	PD0	PD0	CH0

Table 5.28. ADC1 Bus and Pin Mapping

APORT4Y	APORT4X	APORT3Y	APORT3X	APORT2Y	APORT2X	APORT1Y	APORT1X	APORT0Y	APORT0X	Port Bus
BUSDY	BUSDX	BUSCY	BUSCX	BUSBY	BUSBX	BUSAY	BUSAX	BUSADC1Y	BUSADC1X	CH31
PF14	PF15	PF15	PF14	PF14	PF15	PB15	PB14			CH30
PF12	PF13	PF13	PF12	PF12	PF13	PB13	PB12			CH29
PF10	PF11	PF11	PF10	PF10	PF11	PB11	PB10			CH28
PF8	PF9	PF9	PF8		PF9	PB9				CH27
PF6	PF7	PF7	PF6	PF6			PB6			CH26
PF4	PF5	PF5	PF4	PF4	PF5	PB5	PB4			CH25
PF2	PF3	PF3	PF2	PF2	PF3	PB3	PB2			CH24
PF0	PF1	PF1	PF0	PF0	PF1	PB1	PB0			CH23
PE14	PE15	PE15	PE14	PE14	PE15	PA15	PA14			CH22
PE12	PE13	PE13	PE12	PE12	PE13	PA13	PA12			CH21
PE10	PE11	PE11	PE10	PE10	PE11	PA11	PA10			CH20
PE8	PE9	PE9	PE8	PE8	PE9	PA9	PA8			CH19
PE6	PE7	PE7	PE6	PE6	PE7	PA7	PA6	PH7	PH7	CH18
PE4	PE5	PE5	PE4	PE4	PE5	PA5	PA4	PH6	PH6	CH17
								PH5	PH5	CH16
								PH4	PH4	CH15
								PH3	PH3	CH14
								PH2	PH2	CH13
								PH1	PH1	CH12
PE0	PE1	PE1	PE0	PE0	PE1	PA1	PA0	PH0	PH0	CH11
										CH10
										CH9
										CH8
										CH7
										CH6
										CH5
										CH4
										CH3
										CH2
										CH1
										CH0

Table 5.29. CSEN Bus and Pin Mapping

Port	Bus	CH31	CH30	CH29	CH28	CH27	CH26	CH25	CH24	CH23	CH22	CH21	CH20	CH19	CH18	CH17	CH16	CH15	CH14	CH13	CH12	CH11	CH10	CH9	CH8	CH7	CH6	CH5	CH4	CH3	CH2	CH1	CH0	
CEXT																																		
APORT1X	BUSAX			PB14			PB10				PB6		PB4		PB2		PB0		PA15	PA14		PA12		PA10		PA8		PA6		PA4		PA2		PA0
APORT1Y	BUSAY	PB15		PB13		PB11		PB9			PB5		PB3		PB1					PA13		PA11		PA9		PA7		PA5		PA3		PA1		
APORT3X	BUSCX		PF14		PF12		PF10		PF8		PF6		PF4		PF2		PF0		PE14		PE12		PE10		PE8		PE6		PE4				PE0	
APORT3Y	BUSCY	PF15		PF13		PF11		PF9		PF7		PF5		PF3		PF1		PE15		PE13		PE11		PE9		PE7		PE5				PE1		
CEXT_SENSE																																		
APORT2X	BUSBX	PB15		PB13		PB11		PB9			PB5		PB3		PB1			PA15		PA13		PA11		PA9		PA7		PA5		PA3		PA1		
APORT2Y	BUSBY		PB14		PB12		PB10				PB6		PB4		PB2		PB0		PA14		PA12		PA10		PA8		PA6		PA4		PA2		PA0	
APORT4X	BUSDX	PF15		PF13		PF11		PF9		PF7		PF5		PF3		PF1		PE15		PE13		PE11		PE9		PE7		PE5				PE1		
APORT4Y	BUSDY		PF14		PF12		PF10		PF8		PF6		PF4		PF2		PF0		PE14		PE12		PE10		PE8		PE6		PE4				PE0	

Table 5.30. IDAC0 Bus and Pin Mapping

Port	Bus	CH31	CH30	CH29	CH28	CH27	CH26	CH25	CH24	CH23	CH22	CH21	CH20	CH19	CH18	CH17	CH16	CH15	CH14	CH13	CH12	CH11	CH10	CH9	CH8	CH7	CH6	CH5	CH4	CH3	CH2	CH1	CH0	
APORT1X	BUSCX		PF14		PF12		PF10		PF8		PF6		PF4		PF2		PF0		PE14		PE12		PE10		PE8		PE6		PE4				PE0	
APORT1Y	BUSCY	PF15		PF13		PF11		PF9		PF7		PF5		PF3		PF1		PE15		PE13		PE11		PE9		PE7		PE5				PE1		

Table 5.31. VDACC0 / OPA Bus and Pin Mapping

Port	Bus	CH31	CH30	CH29	CH28	CH27	CH26	CH25	CH24	CH23	CH22	CH21	CH20	CH19	CH18	CH17	CH16	CH15	CH14	CH13	CH12	CH11	CH10	CH9	CH8	CH7	CH6	CH5	CH4	CH3	CH2	CH1	CH0
OPA0_N																																	
APORT1Y	BUSAY	PB15		PB13		PB11		PB9				PB5		PB3		PB1		PA15		PA13		PA11		PA9		PA7		PA5		PA3		PA1	
APORT2Y	BUSBY		PB14		PB12		PB10				PB6		PB4		PB2		PB0		PA14		PA12		PA10		PA8		PA6		PA4		PA2		PA0
APORT3Y	BUSCY	PF15		PF13		PF11		PF9		PF7		PF5		PF3		PF1		PE15		PE13		PE11		PE9		PE7		PE5		PE3		PE1	
APORT4Y	BUSDY		PF14		PF12		PF10		PF8		PF6		PF4		PF2		PF0		PE14		PE12		PE10		PE8		PE6		PE4		PE2		PE0
OPA0_P																																	
APORT1X	BUSAX		PB14		PB12		PB10				PB6		PB4		PB2		PB0		PA14		PA12		PA10		PA8		PA6		PA4		PA2		PA0
APORT2X	BUSBX	PB15		PB13		PB11		PB9				PB5		PB3		PB1		PA15		PA13		PA11		PA9		PA7		PA5		PA3		PA1	
APORT3X	BUSCX		PF14		PF12		PF10		PF8		PF6		PF4		PF2		PF0		PE14		PE12		PE10		PE8		PE6		PE4		PE2		PE0
APORT4X	BUSDX	PF15		PF13		PF11		PF9		PF7		PF5		PF3		PF1		PE15		PE13		PE11		PE9		PE7		PE5		PE3		PE1	

Port	Bus	CH31	CH30	CH29	CH28	CH27	CH26	CH25	CH24	CH23	CH22	CH21	CH20	CH19	CH18	CH17	CH16	CH15	CH14	CH13	CH12	CH11	CH10	CH9	CH8	CH7	CH6	CH5	CH4	CH3	CH2	CH1	CH0																								
OPA1_N																																																									
APORT1Y	BUSAY	BUSBY	APORT2Y	BUSBY	APORT3Y	BUSCY	PF15	PF14	PF12	PF11	PF10	PF8	PF6	PF4	PF2	PF0	PE14	PE15	PE14	PE13	PE12	PE11	PE10	PE8	PE6	PE5	PE4	PE0	APORT1Y	BUSAY	BUSBY	APORT2Y	BUSBY	APORT3Y	BUSCY	PF15	PF14	PF12	PF11	PF10	PF8	PF6	PF4	PF2	PF0	PE14	PE15	PE14	PE13	PE12	PE11	PE10	PE8	PE6	PE5	PE4	PE0
OPA1_P																																																									
APORT1X	BUSAX	BUSBX	APORT2X	BUSBX	APORT3X	BUSCX	PF14	PF13	PF12	PF11	PF10	PF8	PF6	PF4	PF2	PF0	PE15	PE14	PE13	PE12	PE11	PE10	PE9	PE8	PE6	PE5	PE4	PE0	APORT1X	BUSAX	BUSBX	APORT2X	BUSBX	APORT3X	BUSCX	PF14	PF13	PF12	PF11	PF10	PF8	PF6	PF4	PF2	PF0	PE15	PE14	PE13	PE12	PE11	PE10	PE9	PE8	PE6	PE5	PE4	PE0
OPA2_N																																																									
APORT1Y	BUSAY	BUSBY	APORT2Y	BUSBY	APORT3Y	BUSCY	PF15	PF14	PF12	PF11	PF10	PF8	PF6	PF4	PF2	PF0	PE15	PE14	PE13	PE12	PE11	PE10	PE9	PE8	PE6	PE5	PE4	PE0	APORT1Y	BUSAY	BUSBY	APORT2Y	BUSBY	APORT3Y	BUSCY	PF15	PF14	PF12	PF11	PF10	PF8	PF6	PF4	PF2	PF0	PE15	PE14	PE13	PE12	PE11	PE10	PE9	PE8	PE6	PE5	PE4	PE0

Port	Bus	CH31	CH30	CH29	CH28	CH27	CH26	CH25	CH24	CH23	CH22	CH21	CH20	CH19	CH18	CH17	CH16	CH15	CH14	CH13	CH12	CH11	CH10	CH9	CH8	CH7	CH6	CH5	CH4	CH3	CH2	CH1	CH0		
OPA2_OUT																																			
APORT1Y	BUSAY	BUSBY	BUSBY	BUSBY	BUSBY	BUSBY	BUSBY	BUSBY	BUSBY	BUSBY	BUSBY	BUSBY	BUSBY	BUSBY	BUSBY	BUSBY	BUSBY	BUSBY	BUSBY	BUSBY	BUSBY	BUSBY	BUSBY	BUSBY	BUSBY	BUSBY	BUSBY	BUSBY	BUSBY	BUSBY	BUSBY	BUSBY	BUSBY	BUSBY	
APORT2Y	BUSBY	BUSBY	BUSBY	BUSBY	BUSBY	BUSBY	BUSBY	BUSBY	BUSBY	BUSBY	BUSBY	BUSBY	BUSBY	BUSBY	BUSBY	BUSBY	BUSBY	BUSBY	BUSBY	BUSBY	BUSBY	BUSBY	BUSBY	BUSBY	BUSBY	BUSBY	BUSBY	BUSBY	BUSBY	BUSBY	BUSBY	BUSBY	BUSBY	BUSBY	
APORT3Y	BUSCY	BUSCY	BUSCY	BUSCY	BUSCY	BUSCY	BUSCY	BUSCY	BUSCY	BUSCY	BUSCY	BUSCY	BUSCY	BUSCY	BUSCY	BUSCY	BUSCY	BUSCY	BUSCY	BUSCY	BUSCY	BUSCY	BUSCY	BUSCY	BUSCY	BUSCY	BUSCY	BUSCY	BUSCY	BUSCY	BUSCY	BUSCY	BUSCY	BUSCY	
APORT4Y	BUSDY	BUSDY	BUSDY	BUSDY	BUSDY	BUSDY	BUSDY	BUSDY	BUSDY	BUSDY	BUSDY	BUSDY	BUSDY	BUSDY	BUSDY	BUSDY	BUSDY	BUSDY	BUSDY	BUSDY	BUSDY	BUSDY	BUSDY	BUSDY	BUSDY	BUSDY	BUSDY	BUSDY	BUSDY	BUSDY	BUSDY	BUSDY	BUSDY	BUSDY	
APORT1X	BUSAX	BUSAX	BUSAX	BUSAX	BUSAX	BUSAX	BUSAX	BUSAX	BUSAX	BUSAX	BUSAX	BUSAX	BUSAX	BUSAX	BUSAX	BUSAX	BUSAX	BUSAX	BUSAX	BUSAX	BUSAX	BUSAX	BUSAX	BUSAX	BUSAX	BUSAX	BUSAX	BUSAX	BUSAX	BUSAX	BUSAX	BUSAX	BUSAX	BUSAX	
APORT2X	BUSBX	BUSBX	BUSBX	BUSBX	BUSBX	BUSBX	BUSBX	BUSBX	BUSBX	BUSBX	BUSBX	BUSBX	BUSBX	BUSBX	BUSBX	BUSBX	BUSBX	BUSBX	BUSBX	BUSBX	BUSBX	BUSBX	BUSBX	BUSBX	BUSBX	BUSBX	BUSBX	BUSBX	BUSBX	BUSBX	BUSBX	BUSBX	BUSBX	BUSBX	
APORT3X	BUSCX	BUSCX	BUSCX	BUSCX	BUSCX	BUSCX	BUSCX	BUSCX	BUSCX	BUSCX	BUSCX	BUSCX	BUSCX	BUSCX	BUSCX	BUSCX	BUSCX	BUSCX	BUSCX	BUSCX	BUSCX	BUSCX	BUSCX	BUSCX	BUSCX	BUSCX	BUSCX	BUSCX	BUSCX	BUSCX	BUSCX	BUSCX	BUSCX	BUSCX	
APORT4X	BUSDX	BUSDX	BUSDX	BUSDX	BUSDX	BUSDX	BUSDX	BUSDX	BUSDX	BUSDX	BUSDX	BUSDX	BUSDX	BUSDX	BUSDX	BUSDX	BUSDX	BUSDX	BUSDX	BUSDX	BUSDX	BUSDX	BUSDX	BUSDX	BUSDX	BUSDX	BUSDX	BUSDX	BUSDX	BUSDX	BUSDX	BUSDX	BUSDX	BUSDX	
OPA3_IN																																			
APORT1Y	BUSAY	BUSAY	BUSAY	BUSAY	BUSAY	BUSAY	BUSAY	BUSAY	BUSAY	BUSAY	BUSAY	BUSAY	BUSAY	BUSAY	BUSAY	BUSAY	BUSAY	BUSAY	BUSAY	BUSAY	BUSAY	BUSAY	BUSAY	BUSAY	BUSAY	BUSAY	BUSAY	BUSAY	BUSAY	BUSAY	BUSAY	BUSAY	BUSAY	BUSAY	
APORT2Y	BUSBY	BUSBY	BUSBY	BUSBY	BUSBY	BUSBY	BUSBY	BUSBY	BUSBY	BUSBY	BUSBY	BUSBY	BUSBY	BUSBY	BUSBY	BUSBY	BUSBY	BUSBY	BUSBY	BUSBY	BUSBY	BUSBY	BUSBY	BUSBY	BUSBY	BUSBY	BUSBY	BUSBY	BUSBY	BUSBY	BUSBY	BUSBY	BUSBY	BUSBY	
APORT3Y	BUSCY	BUSCY	BUSCY	BUSCY	BUSCY	BUSCY	BUSCY	BUSCY	BUSCY	BUSCY	BUSCY	BUSCY	BUSCY	BUSCY	BUSCY	BUSCY	BUSCY	BUSCY	BUSCY	BUSCY	BUSCY	BUSCY	BUSCY	BUSCY	BUSCY	BUSCY	BUSCY	BUSCY	BUSCY	BUSCY	BUSCY	BUSCY	BUSCY	BUSCY	BUSCY
APORT4Y	BUSDY	BUSDY	BUSDY	BUSDY	BUSDY	BUSDY	BUSDY	BUSDY	BUSDY	BUSDY	BUSDY	BUSDY	BUSDY	BUSDY	BUSDY	BUSDY	BUSDY	BUSDY	BUSDY	BUSDY	BUSDY	BUSDY	BUSDY	BUSDY	BUSDY	BUSDY	BUSDY	BUSDY	BUSDY	BUSDY	BUSDY	BUSDY	BUSDY	BUSDY	BUSDY

Port	Bus	CH31	CH30	CH29	CH28	CH27	CH26	CH25	CH24	CH23	CH22	CH21	CH20	CH19	CH18	CH17	CH16	CH15	CH14	CH13	CH12	CH11	CH10	CH9	CH8	CH7	CH6	CH5	CH4	CH3	CH2	CH1	CH0		
VDAC0_OUT1 / OPA1_OUT																																			
APORT4Y	BUSDY	APORT3Y	BUSCY	APORT2Y	BUSBY	APORT1Y	APORT1Y																												
			PF15		PB14																														
	PF14				PB13																														
			PF13																																
	PF12				PB12																														
			PF11																																
	PF10				PB10																														
			PF9																																
	PF8																																		
			PF7																																
	PF6				PB6																														
			PF5																																
	PF4				PB4																														
			PF3																																
	PF2				PB2																														
			PF1																																
	PF0																																		
			PE15																																
	PE14				PA14																														
			PE13																																
	PE12				PA12																														
			PE11																																
	PE10				PA10																														
			PE9																																
	PE8				PA8																														
			PE7																																
	PE6				PA6																														
			PE5																																
	PE4				PA4																														
			PE1																																
	PE0				PA0																														

6. BGA192 Package Specifications

6.1 BGA192 Package Dimensions



Figure 6.1. BGA192 Package Drawing

Table 6.1. BGA192 Package Dimensions

Dimension	Min	Typ	Max
A	0.77	0.83	0.89
A1	0.13	0.18	0.23
A3	0.16	0.20	0.24
A2	0.45 REF		
D	7.00 BSC		
e	0.40 BSC		
E	7.00 BSC		
D1	6.00 BSC		
E1	6.00 BSC		
b	0.20	0.25	0.30
aaa	0.10		
bbb	0.10		
ddd	0.08		
eee	0.15		
fff	0.05		

Note:

1. All dimensions shown are in millimeters (mm) unless otherwise noted.
2. Dimensioning and Tolerancing per ANSI Y14.5M-1994.
3. Recommended card reflow profile is per the JEDEC/IPC J-STD-020 specification for Small Body Components.

6.2 BGA192 PCB Land Pattern

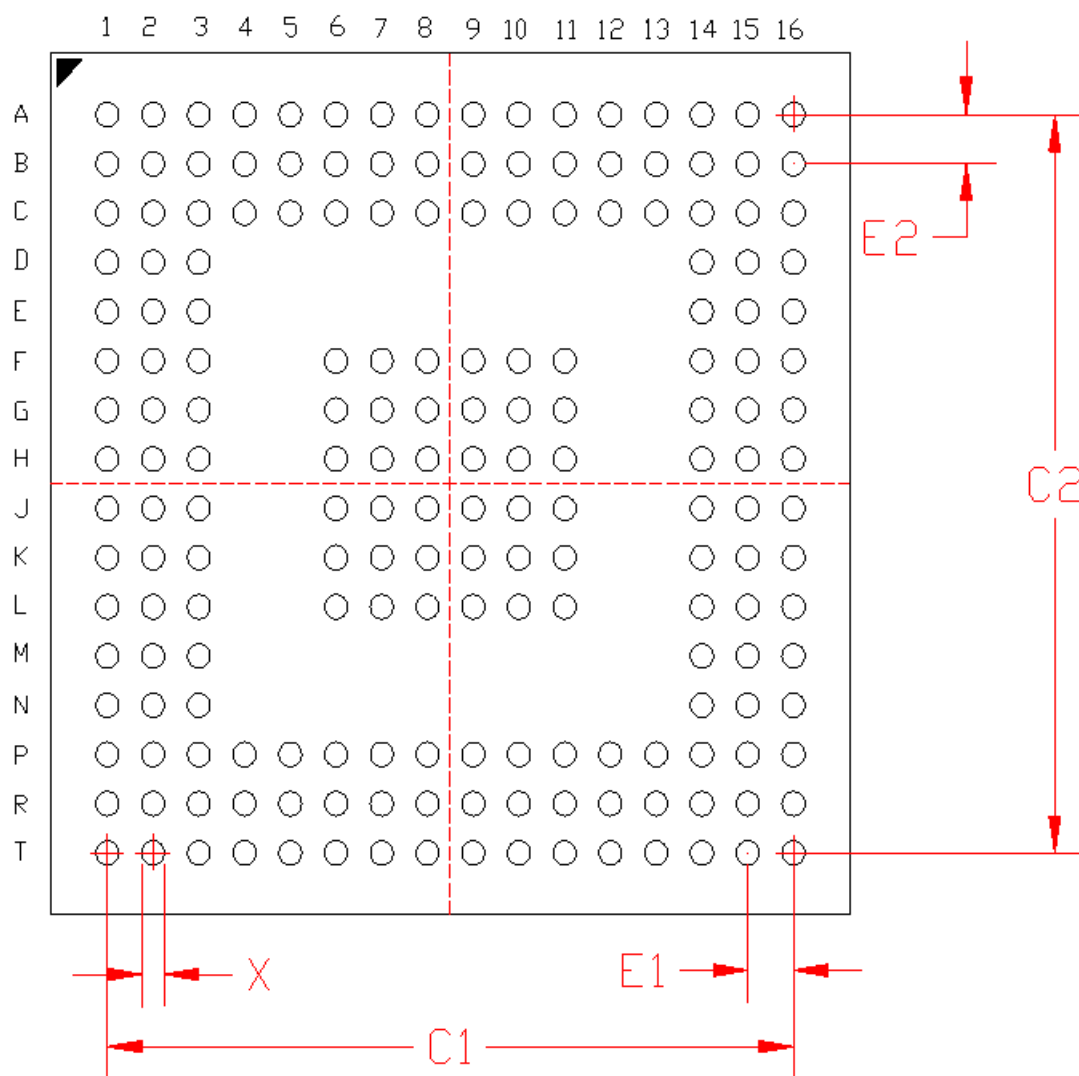

Figure 6.2. BGA192 PCB Land Pattern Drawing

Table 6.2. BGA192 PCB Land Pattern Dimensions

Dimension	Min	Nom	Max
X		0.20	
C1		6.00	
C2		6.00	
E1		0.4	
E2		0.4	

Note:

1. All dimensions shown are in millimeters (mm) unless otherwise noted.
2. Dimensioning and Tolerancing is per the ANSI Y14.5M-1994 specification.
3. This Land Pattern Design is based on the IPC-7351 guidelines.
4. All metal pads are to be non-solder mask defined (NSMD). Clearance between the solder mask and the metal pad is to be 60 µm minimum, all the way around the pad.
5. A stainless steel, laser-cut and electro-polished stencil with trapezoidal walls should be used to assure good solder paste release.
6. The stencil thickness should be 0.125 mm (5 mils).
7. The ratio of stencil aperture to land pad size should be 1:1.
8. A No-Clean, Type-3 solder paste is recommended.
9. The recommended card reflow profile is per the JEDEC/IPC J-STD-020C specification for Small Body Components.

6.3 BGA192 Package Marking



Figure 6.3. BGA192 Package Marking

The package marking consists of:

- P P P P P P P P P P – The part number designation.
- T T T T T T – A trace or manufacturing code. The first letter is the device revision.
- Y Y – The last 2 digits of the assembly year.
- W W – The 2-digit workweek when the device was assembled.

7. BGA152 Package Specifications

7.1 BGA152 Package Dimensions

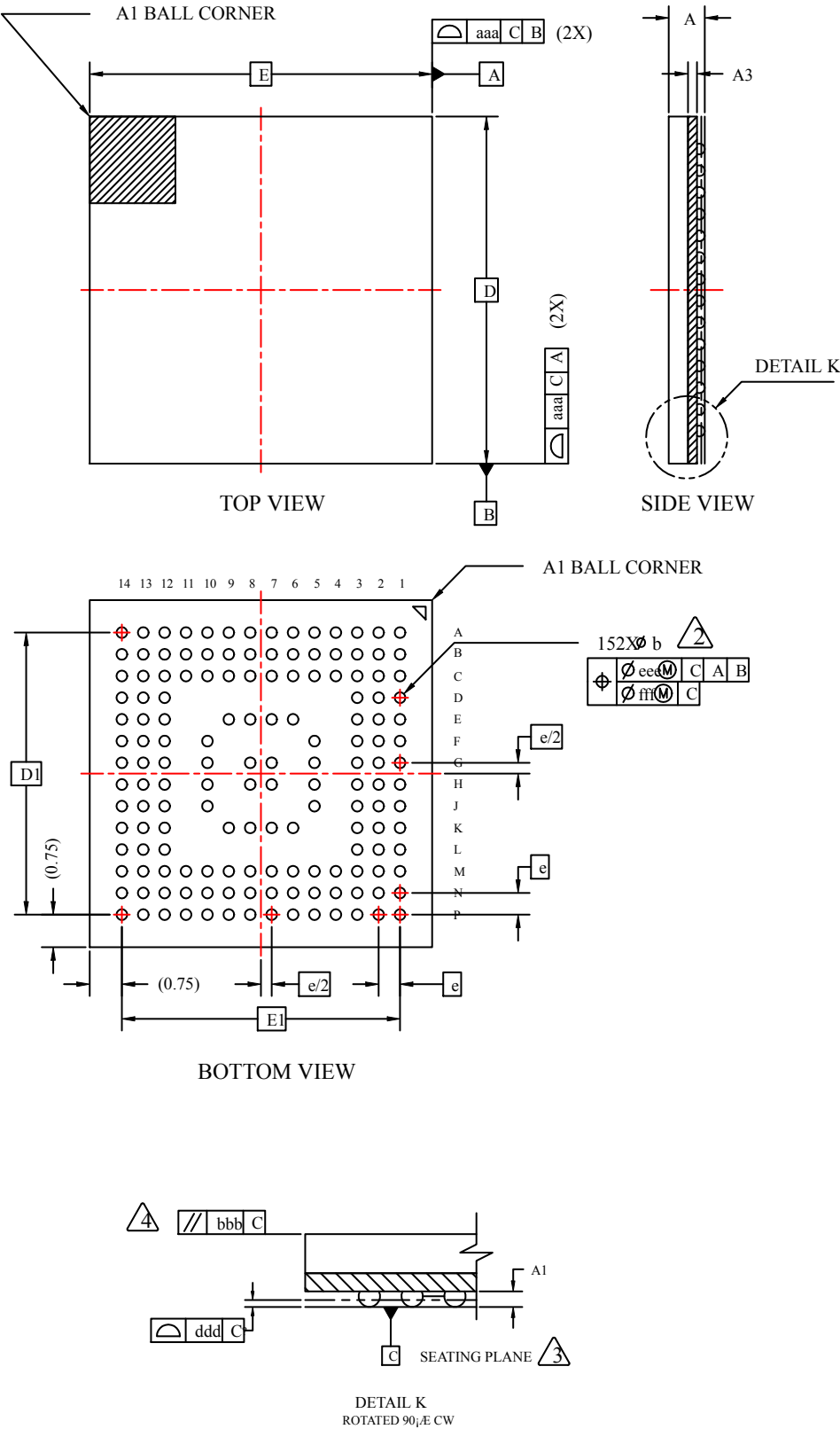

Figure 7.1. BGA152 Package Drawing

Table 7.1. BGA152 Package Dimensions

Dimension	Min	Typ	Max
A	0.78	0.84	0.90
A1	0.13	0.18	0.23
A3	0.16	0.20	0.24
A2	0.45 REF		
D	8.00 BSC		
e	0.50 BSC		
E	8.00 BSC		
D1	6.50 BSC		
E1	6.50 BSC		
b	0.20	0.25	0.30
aaa	0.10		
bbb	0.10		
ddd	0.08		
eee	0.15		
fff	0.05		

Note:

1. All dimensions shown are in millimeters (mm) unless otherwise noted.
2. Dimensioning and Tolerancing per ANSI Y14.5M-1994.
3. Recommended card reflow profile is per the JEDEC/IPC J-STD-020 specification for Small Body Components.

7.2 BGA152 PCB Land Pattern

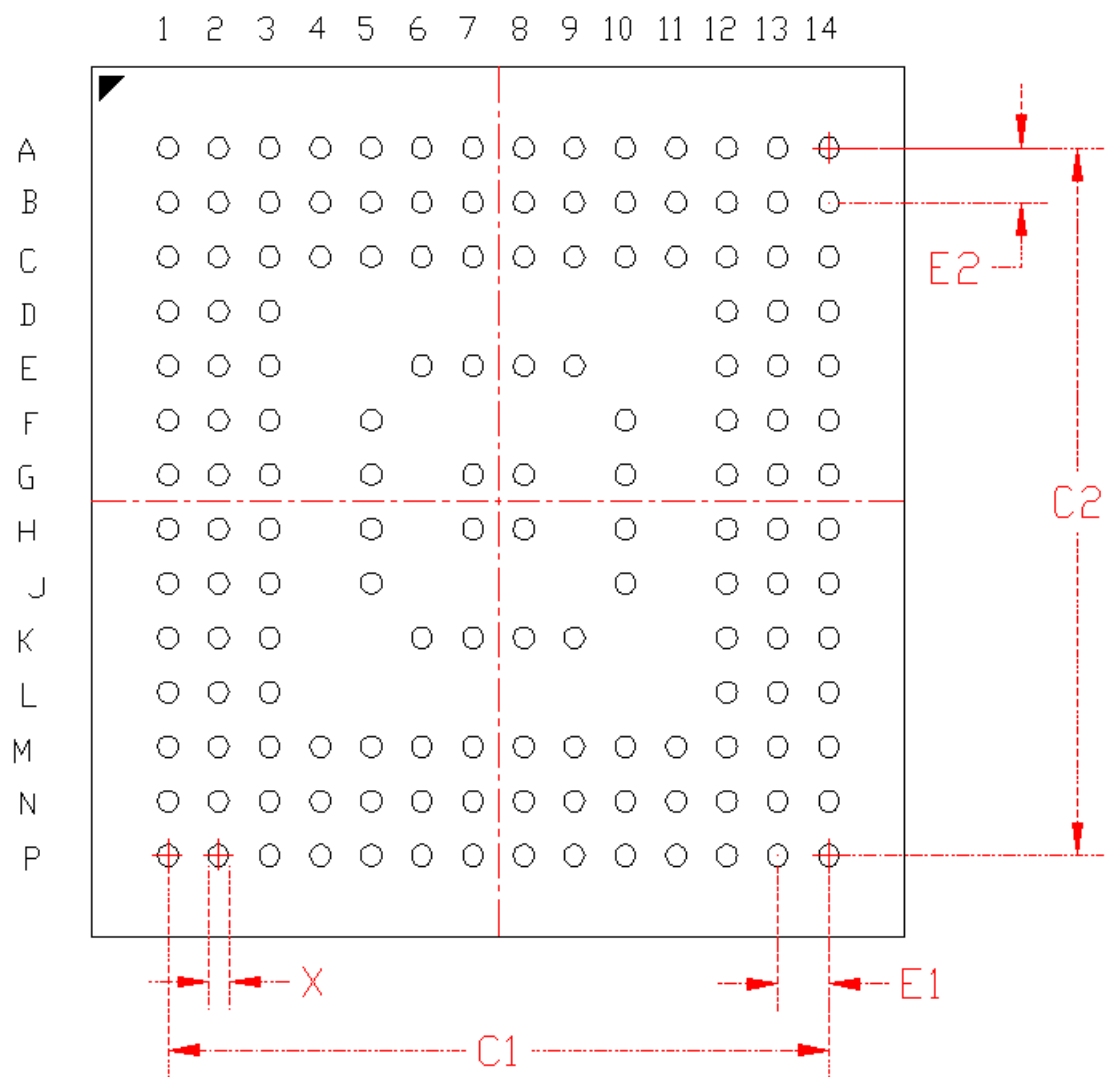

Figure 7.2. BGA152 PCB Land Pattern Drawing

Table 7.2. BGA152 PCB Land Pattern Dimensions

Dimension	Min	Nom	Max
X		0.20	
C1		6.50	
C2		6.50	
E1		0.5	
E2		0.5	

Note:

1. All dimensions shown are in millimeters (mm) unless otherwise noted.
2. Dimensioning and Tolerancing is per the ANSI Y14.5M-1994 specification.
3. This Land Pattern Design is based on the IPC-7351 guidelines.
4. All metal pads are to be non-solder mask defined (NSMD). Clearance between the solder mask and the metal pad is to be 60 µm minimum, all the way around the pad.
5. A stainless steel, laser-cut and electro-polished stencil with trapezoidal walls should be used to assure good solder paste release.
6. The stencil thickness should be 0.125 mm (5 mils).
7. The ratio of stencil aperture to land pad size should be 1:1.
8. A No-Clean, Type-3 solder paste is recommended.
9. The recommended card reflow profile is per the JEDEC/IPC J-STD-020C specification for Small Body Components.

7.3 BGA152 Package Marking



Figure 7.3. BGA152 Package Marking

The package marking consists of:

- P P P P P P P P P P – The part number designation.
- T T T T T T – A trace or manufacturing code. The first letter is the device revision.
- Y Y – The last 2 digits of the assembly year.
- W W – The 2-digit workweek when the device was assembled.

8. BGA120 Package Specifications

8.1 BGA120 Package Dimensions

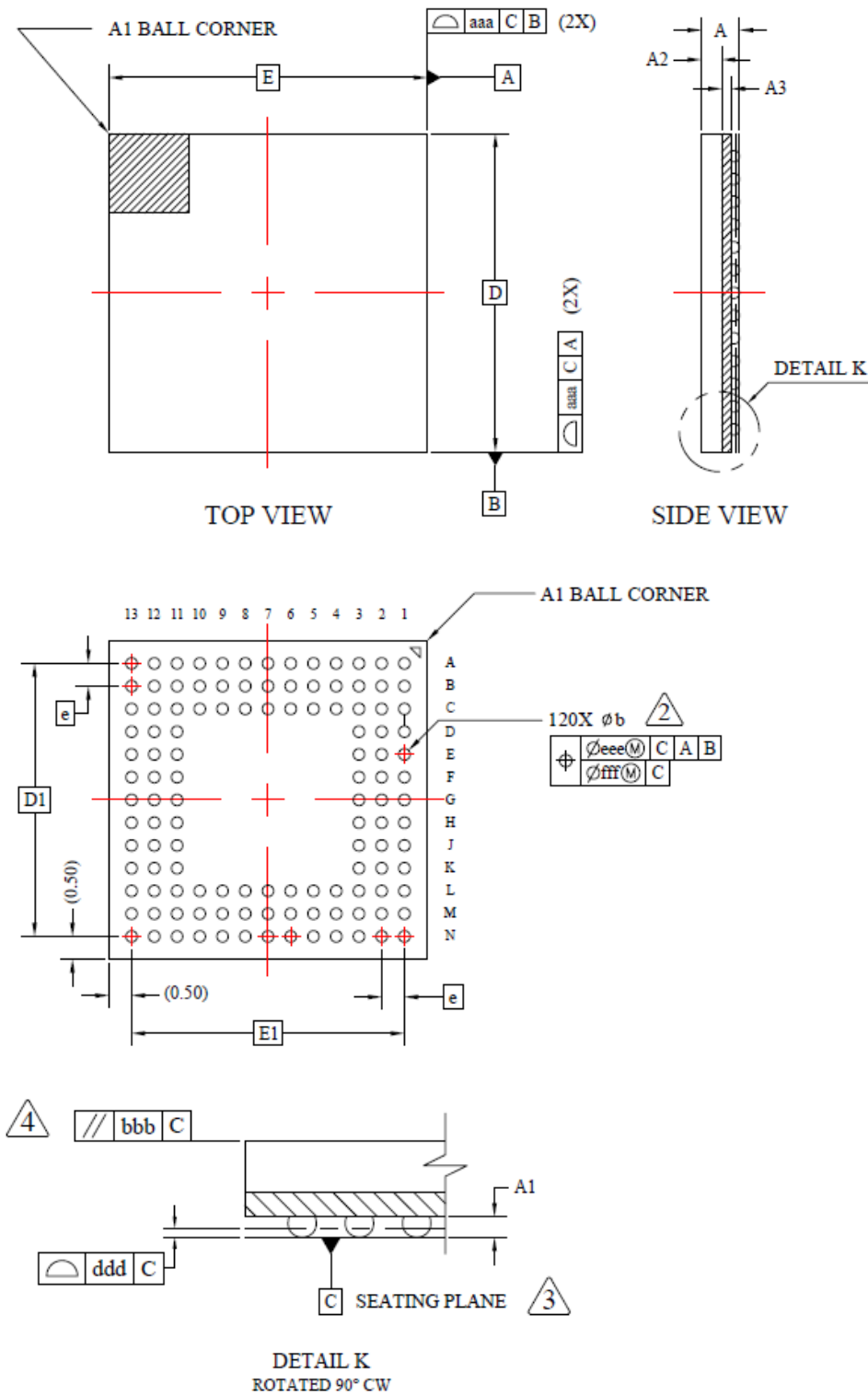

Figure 8.1. BGA120 Package Drawing

Table 8.1. BGA120 Package Dimensions

Dimension	Min	Typ	Max
A	0.78	0.84	0.90
A1	0.13	0.18	0.23
A3	0.17	0.21	0.25
A2	0.45 REF		
D	7.00 BSC		
e	0.50 BSC		
E	7.00 BSC		
D1	6.00 BSC		
E1	6.00 BSC		
b	0.20	0.25	0.30
aaa	0.10		
bbb	0.10		
ddd	0.08		
eee	0.15		
fff	0.05		

Note:

1. All dimensions shown are in millimeters (mm) unless otherwise noted.
2. Dimensioning and Tolerancing per ANSI Y14.5M-1994.
3. Recommended card reflow profile is per the JEDEC/IPC J-STD-020 specification for Small Body Components.

8.2 BGA120 PCB Land Pattern

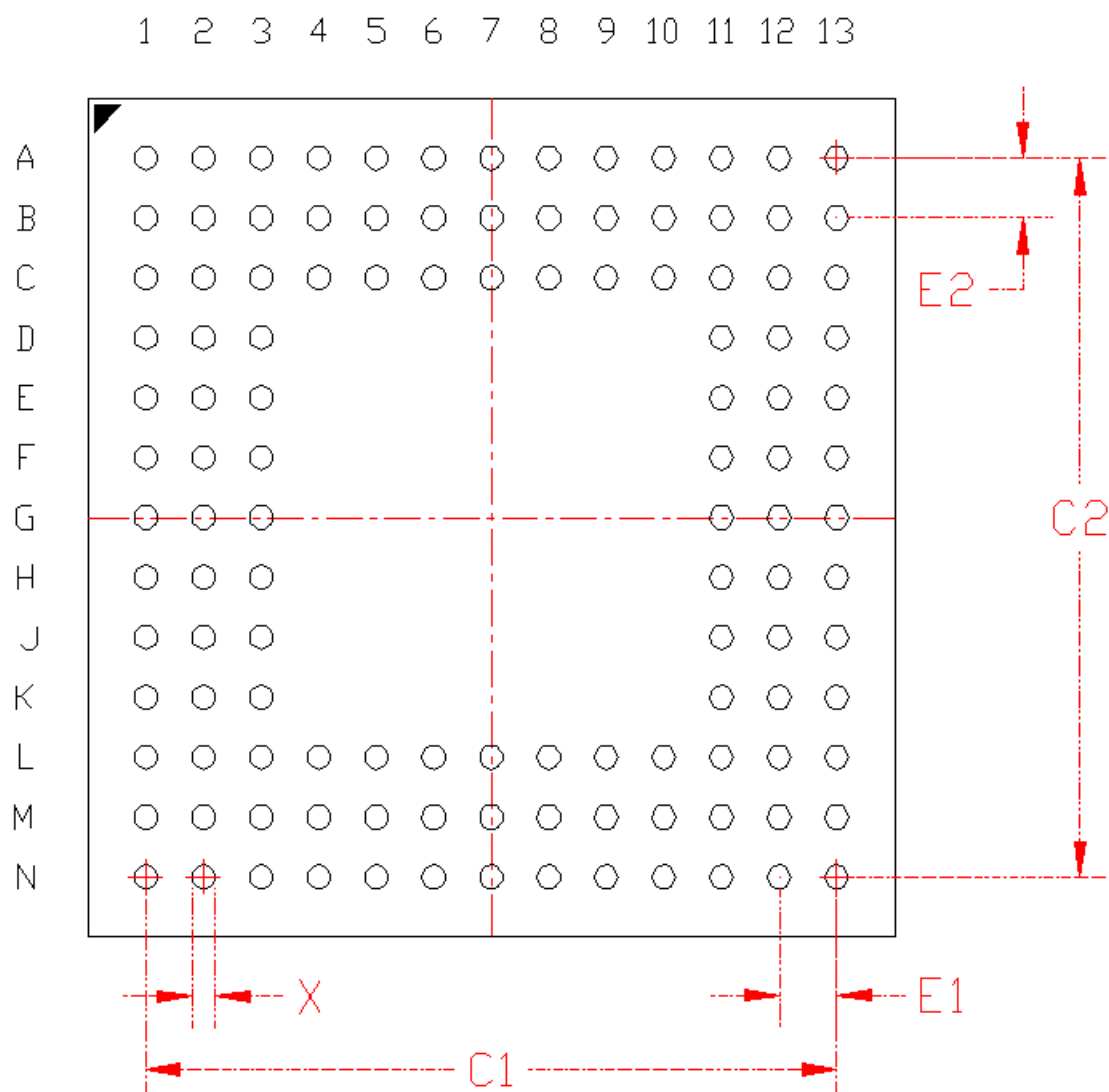

Figure 8.2. BGA120 PCB Land Pattern Drawing

Table 8.2. BGA120 PCB Land Pattern Dimensions

Dimension	Min	Nom	Max
X		0.20	
C1		6.00	
C2		6.00	
E1		0.5	
E2		0.5	

Note:

1. All dimensions shown are in millimeters (mm) unless otherwise noted.
2. Dimensioning and Tolerancing is per the ANSI Y14.5M-1994 specification.
3. This Land Pattern Design is based on the IPC-7351 guidelines.
4. All metal pads are to be non-solder mask defined (NSMD). Clearance between the solder mask and the metal pad is to be 60 µm minimum, all the way around the pad.
5. A stainless steel, laser-cut and electro-polished stencil with trapezoidal walls should be used to assure good solder paste release.
6. The stencil thickness should be 0.125 mm (5 mils).
7. The ratio of stencil aperture to land pad size should be 1:1.
8. A No-Clean, Type-3 solder paste is recommended.
9. The recommended card reflow profile is per the JEDEC/IPC J-STD-020C specification for Small Body Components.

8.3 BGA120 Package Marking



Figure 8.3. BGA120 Package Marking

The package marking consists of:

- P P P P P P P P P P – The part number designation.
- T T T T T T – A trace or manufacturing code. The first letter is the device revision.
- Y Y – The last 2 digits of the assembly year.
- W W – The 2-digit workweek when the device was assembled.

9. BGA112 Package Specifications

9.1 BGA112 Package Dimensions

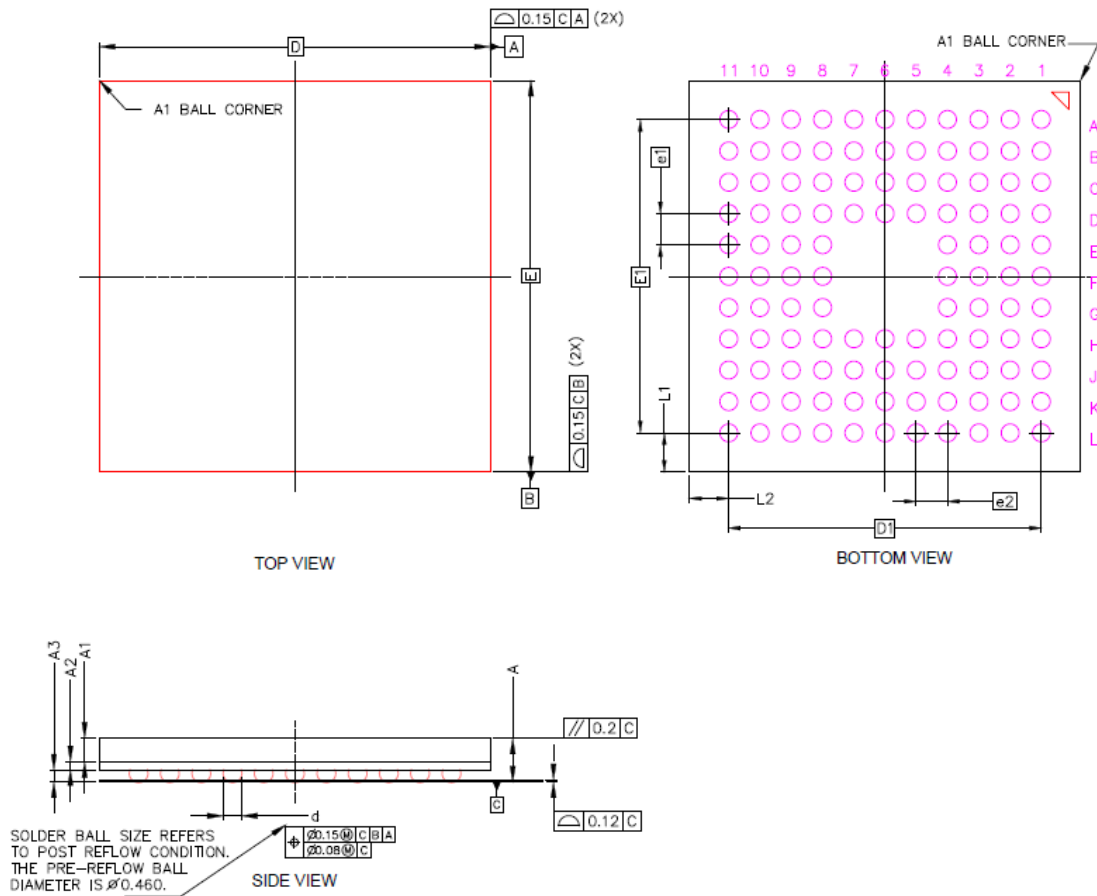

Figure 9.1. BGA112 Package Drawing

Table 9.1. BGA112 Package Dimensions

Dimension	Min	Typ	Max
A	-	-	1.30
A1	0.55	0.60	0.65
A2	0.21 BSC		
A3	0.30	0.35	0.40
d	0.43	0.48	0.53
D	10.00 BSC		
D1	8.00 BSC		
E	10.00 BSC		
E1	8.00 BSC		
e1	0.80 BSC		
e2	0.80 BSC		
L1	1.00 REF		
L2	1.00 REF		

Note:

1. All dimensions shown are in millimeters (mm) unless otherwise noted.
2. Dimensioning and Tolerancing per ANSI Y14.5M-1994.
3. Recommended card reflow profile is per the JEDEC/IPC J-STD-020 specification for Small Body Components.

9.2 BGA112 PCB Land Pattern

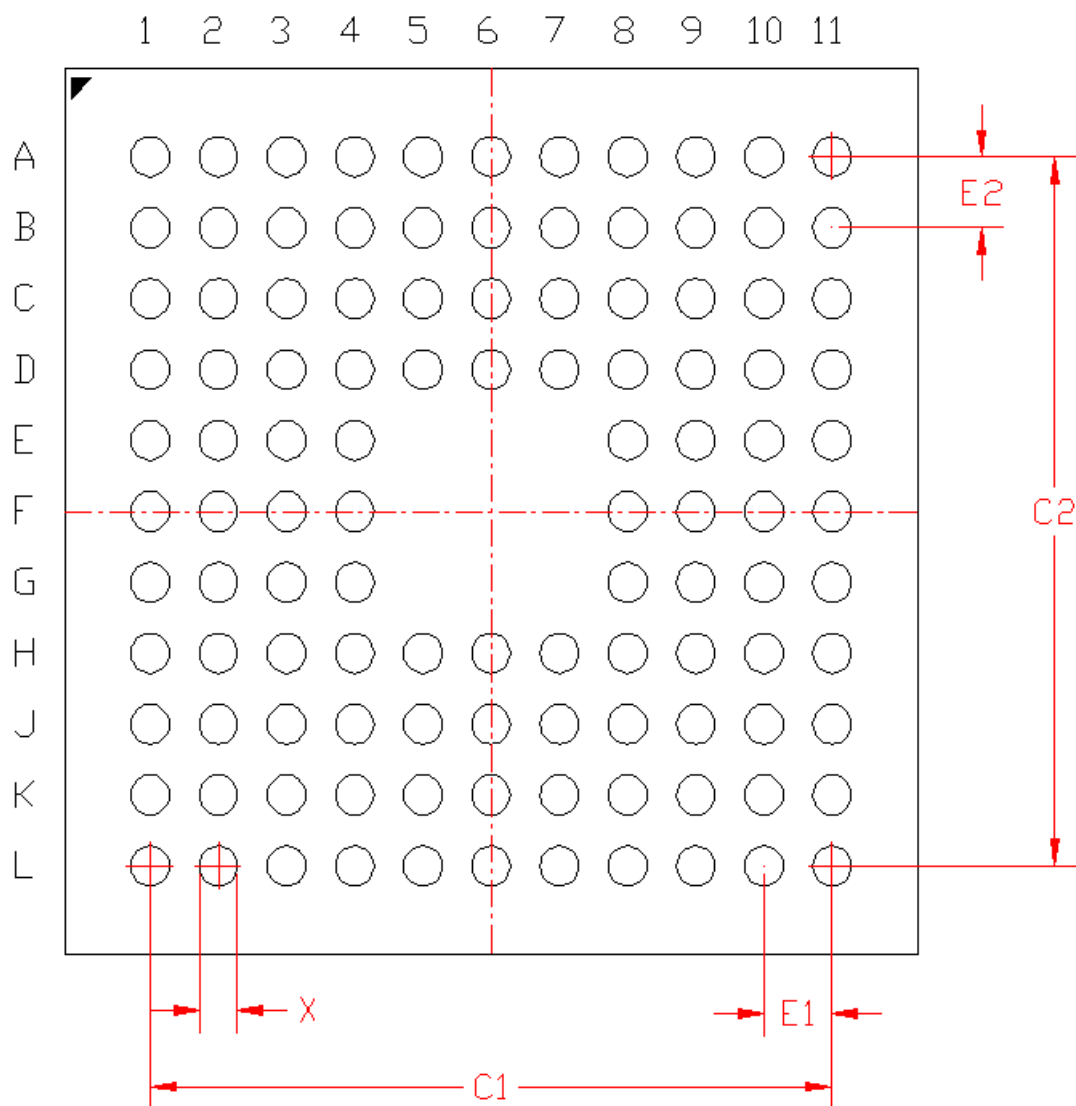

Figure 9.2. BGA112 PCB Land Pattern Drawing

Table 9.2. BGA112 PCB Land Pattern Dimensions

Dimension	Min	Nom	Max
X		0.45	
C1		8.00	
C2		8.00	
E1		0.8	
E2		0.8	

Note:

1. All dimensions shown are in millimeters (mm) unless otherwise noted.
2. Dimensioning and Tolerancing is per the ANSI Y14.5M-1994 specification.
3. This Land Pattern Design is based on the IPC-7351 guidelines.
4. All metal pads are to be non-solder mask defined (NSMD). Clearance between the solder mask and the metal pad is to be 60 µm minimum, all the way around the pad.
5. A stainless steel, laser-cut and electro-polished stencil with trapezoidal walls should be used to assure good solder paste release.
6. The stencil thickness should be 0.125 mm (5 mils).
7. The ratio of stencil aperture to land pad size should be 1:1.
8. A No-Clean, Type-3 solder paste is recommended.
9. The recommended card reflow profile is per the JEDEC/IPC J-STD-020C specification for Small Body Components.

9.3 BGA112 Package Marking



Figure 9.3. BGA112 Package Marking

The package marking consists of:

- P P P P P P P P P P – The part number designation.
- T T T T T T – A trace or manufacturing code. The first letter is the device revision.
- Y Y – The last 2 digits of the assembly year.
- W W – The 2-digit workweek when the device was assembled.

10. TQFP100 Package Specifications

10.1 TQFP100 Package Dimensions



Figure 10.1. TQFP100 Package Drawing

Table 10.1. TQFP100 Package Dimensions

Dimension	Min	Typ	Max
A	-	-	1.20
A1	0.05	-	0.15
A2	0.95	1.00	1.05
b	0.17	0.22	0.27
b1	0.17	0.20	0.23
c	0.09	-	0.20
c1	0.09	-	0.16
D	16.0 BSC		
E	16.0 BSC		
D1	14.0 BSC		
E1	14.0 BSC		
e	0.50 BSC		
L1	1 REF		
L	0.45	0.60	0.75
Θ	0	3.5	7
Θ 1	0	-	-
Θ 2	11	12	13
Θ 3	11	12	13
R1	0.08	-	-
R2	0.08	-	0.2
S	0.2	-	-
aaa	0.2		
bbb	0.2		
ccc	0.08		
ddd	0.08		
eee	0.05		

Note:

1. All dimensions shown are in millimeters (mm) unless otherwise noted.
2. Dimensioning and Tolerancing per ANSI Y14.5M-1994.
3. Recommended card reflow profile is per the JEDEC/IPC J-STD-020 specification for Small Body Components.

10.2 TQFP100 PCB Land Pattern



Figure 10.2. TQFP100 PCB Land Pattern Drawing

Table 10.2. TQFP100 PCB Land Pattern Dimensions

Dimension	Min	Nom	Max
C1		15.4	
C2		15.4	
E		0.50 BSC	
X		0.30	
Y		1.50	

Note:

1. All dimensions shown are in millimeters (mm) unless otherwise noted.
2. This Land Pattern Design is based on the IPC-7351 guidelines.
3. All metal pads are to be non-solder mask defined (NSMD). Clearance between the solder mask and the metal pad is to be 60 µm minimum, all the way around the pad.
4. A stainless steel, laser-cut and electro-polished stencil with trapezoidal walls should be used to assure good solder paste release.
5. The stencil thickness should be 0.125 mm (5 mils).
6. The ratio of stencil aperture to land pad size should be 1:1 for all perimeter pads.
7. A No-Clean, Type-3 solder paste is recommended.
8. The recommended card reflow profile is per the JEDEC/IPC J-STD-020C specification for Small Body Components.

10.3 TQFP100 Package Marking



Figure 10.3. TQFP100 Package Marking

The package marking consists of:

- P P P P P P P P P P – The part number designation.
- T T T T T T – A trace or manufacturing code. The first letter is the device revision.
- Y Y – The last 2 digits of the assembly year.
- W W – The 2-digit workweek when the device was assembled.

11. TQFP64 Package Specifications

11.1 TQFP64 Package Dimensions



Figure 11.1. TQFP64 Package Drawing

Table 11.1. TQFP64 Package Dimensions

Dimension	Min	Typ	Max
A	—	1.15	1.20
A1	0.05	—	0.15
A2	0.95	1.00	1.05
b	0.17	0.22	0.27
b1	0.17	0.20	0.23
c	0.09	—	0.20
c1	0.09	—	0.16
D	12.00 BSC		
D1	10.00 BSC		
e	0.50 BSC		
E	12.00 BSC		
E1	10.00 BSC		
L	0.45	0.60	0.75
L1	1.00 REF		
R1	0.08	—	—
R2	0.08	—	0.20
S	0.20	—	—
θ	0	3.5	7
θ1	0	—	0.10
θ2	11	12	13
θ3	11	12	13

Note:

1. All dimensions shown are in millimeters (mm) unless otherwise noted.
2. Dimensioning and Tolerancing per ANSI Y14.5M-1994.
3. Recommended card reflow profile is per the JEDEC/IPC J-STD-020 specification for Small Body Components.

11.2 TQFP64 PCB Land Pattern

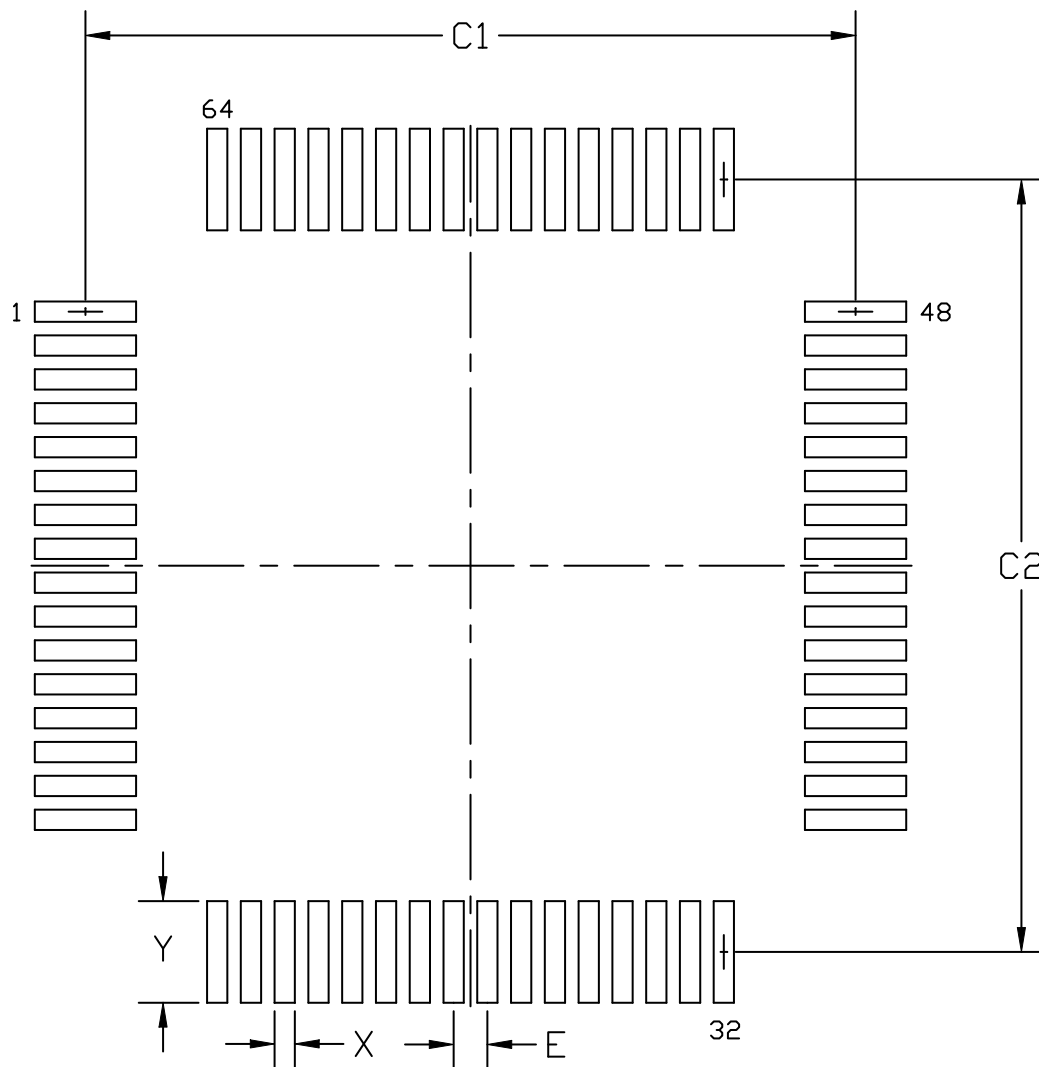

Figure 11.2. TQFP64 PCB Land Pattern Drawing

Table 11.2. TQFP64 PCB Land Pattern Dimensions

Dimension	Min	Max
C1	11.30	11.40
C2	11.30	11.40
E	0.50 BSC	
X	0.20	0.30
Y	1.40	1.50

Note:

1. All dimensions shown are in millimeters (mm) unless otherwise noted.
2. This Land Pattern Design is based on the IPC-7351 guidelines.
3. All metal pads are to be non-solder mask defined (NSMD). Clearance between the solder mask and the metal pad is to be 60 µm minimum, all the way around the pad.
4. A stainless steel, laser-cut and electro-polished stencil with trapezoidal walls should be used to assure good solder paste release.
5. The stencil thickness should be 0.125 mm (5 mils).
6. The ratio of stencil aperture to land pad size can be 1:1 for all pads.
7. A No-Clean, Type-3 solder paste is recommended.
8. The recommended card reflow profile is per the JEDEC/IPC J-STD-020 specification for Small Body Components.

11.3 TQFP64 Package Marking



Figure 11.3. TQFP64 Package Marking

The package marking consists of:

- P P P P P P P P P P – The part number designation.
- T T T T T T – A trace or manufacturing code. The first letter is the device revision.
- Y Y – The last 2 digits of the assembly year.
- W W – The 2-digit workweek when the device was assembled.

12. QFN64 Package Specifications

12.1 QFN64 Package Dimensions



Figure 12.1. QFN64 Package Drawing

Table 12.1. QFN64 Package Dimensions

Dimension	Min	Typ	Max
A	0.70	0.75	0.80
A1	0.00	—	0.05
b	0.20	0.25	0.30
A3	0.203 REF		
D	9.00 BSC		
e	0.50 BSC		
E	9.00 BSC		
D2	7.10	7.20	7.30
E2	7.10	7.20	7.30
L	0.40	0.45	0.50
L1	0.00	—	0.10
aaa	0.10		
bbb	0.10		
ccc	0.10		
ddd	0.05		
eee	0.08		

Note:

1. All dimensions shown are in millimeters (mm) unless otherwise noted.
2. Dimensioning and Tolerancing per ANSI Y14.5M-1994.
3. Recommended card reflow profile is per the JEDEC/IPC J-STD-020 specification for Small Body Components.

12.2 QFN64 PCB Land Pattern



Figure 12.2. QFN64 PCB Land Pattern Drawing

Table 12.2. QFN64 PCB Land Pattern Dimensions

Dimension	Typ
C1	8.90
C2	8.90
E	0.50
X1	0.30
Y1	0.85
X2	7.30
Y2	7.30

Note:

1. All dimensions shown are in millimeters (mm) unless otherwise noted.
2. This Land Pattern Design is based on the IPC-7351 guidelines.
3. All dimensions shown are at Maximum Material Condition (MMC). Least Material Condition (LMC) is calculated based on a Fabrication Allowance of 0.05mm.
4. All metal pads are to be non-solder mask defined (NSMD). Clearance between the solder mask and the metal pad is to be 60 µm minimum, all the way around the pad.
5. A stainless steel, laser-cut and electro-polished stencil with trapezoidal walls should be used to assure good solder paste release.
6. The stencil thickness should be 0.125 mm (5 mils).
7. The ratio of stencil aperture to land pad size can be 1:1 for all pads.
8. A 3x3 array of 1.45 mm square openings on a 2.00 mm pitch can be used for the center ground pad.
9. A No-Clean, Type-3 solder paste is recommended.
10. The recommended card reflow profile is per the JEDEC/IPC J-STD-020 specification for Small Body Components.

12.3 QFN64 Package Marking



Figure 12.3. QFN64 Package Marking

The package marking consists of:

- P P P P P P P P P P – The part number designation.
- T T T T T T – A trace or manufacturing code. The first letter is the device revision.
- Y Y – The last 2 digits of the assembly year.
- W W – The 2-digit workweek when the device was assembled.

13. Revision History

Revision 1.2

May, 2023

- Removed "Not Recommended for New Designs" note from [2. Ordering Information](#).

Revision 1.1

October, 2022

- Front page block diagram and [3.5.4 Low Energy Timer \(LETIMER\)](#) updated to reflect EM3 as the lowest LETIMER energy mode.
- BGA152 variants noted as Not Recommended for New Designs (NRND) in [2. Ordering Information](#).
- Updated [3.5.3 Real Time Counter and Calendar \(RTCC\)](#) to specify that any of the low-frequency oscillators can be used as a clock source.
- [3.12 Configuration Summary](#) updated to reflect whether or not the temperature sensor is present on ADCn.
- Clarified input threshold voltage and pull resistor specifications in [4.1.12 General-Purpose I/O \(GPIO\)](#).

Revision 0.6

March, 2018

- Removed "Confidential" watermark.
- Updated [4.1 Electrical Characteristics](#) and [4.2 Typical Performance Curves](#) with latest characterization data.

Revision 0.2

October, 2017

- Updated memory maps to latest formatting and to include all peripherals.
- Updated all electrical specifications tables with latest characterization results.
- **Absolute Maximum Ratings** Table:
 - Removed redundant I_{VSSMAX} line.
 - Added footnote to clarify V_{DIGPIN} specification for 5V tolerant GPIO.
- **General Operating Conditions** Table:
 - Removed dV_{DD} specification and redundant footnote about shorting VREGVDD and AVDD together.
 - Added footnote about IOVDD voltage restriction when CSEN peripheral is used with chopping enabled.
- **Flash Memory Characteristics** Table: Added timing measurement clarification for Device Erase and Mass Erase.
- **Analog to Digital Converter (ADC)** Table:
 - Added header text for general specification conditions.
 - Added footnote for clarification of input voltage limits.
- Minor typographical corrections, including capitalization, mis-spellings and punctuation marks, throughout document.
- Minor formatting and styling updates, including table formats, TOC location, and boilerplate information throughout document.

Revision 0.1

April 27th, 2017

Initial release.

Simplicity Studio

One-click access to MCU and wireless tools, documentation, software, source code libraries & more. Available for Windows, Mac and Linux!



IoT Portfolio
www.silabs.com/IoT



SW/HW
www.silabs.com/simplicity



Quality
www.silabs.com/quality



Support & Community
www.silabs.com/community

Disclaimer

Silicon Labs intends to provide customers with the latest, accurate, and in-depth documentation of all peripherals and modules available for system and software implementers using or intending to use the Silicon Labs products. Characterization data, available modules and peripherals, memory sizes and memory addresses refer to each specific device, and "Typical" parameters provided can and do vary in different applications. Application examples described herein are for illustrative purposes only. Silicon Labs reserves the right to make changes without further notice to the product information, specifications, and descriptions herein, and does not give warranties as to the accuracy or completeness of the included information. Without prior notification, Silicon Labs may update product firmware during the manufacturing process for security or reliability reasons. Such changes will not alter the specifications or the performance of the product. Silicon Labs shall have no liability for the consequences of use of the information supplied in this document. This document does not imply or expressly grant any license to design or fabricate any integrated circuits. The products are not designed or authorized to be used within any FDA Class III devices, applications for which FDA premarket approval is required or Life Support Systems without the specific written consent of Silicon Labs. A "Life Support System" is any product or system intended to support or sustain life and/or health, which, if it fails, can be reasonably expected to result in significant personal injury or death. Silicon Labs products are not designed or authorized for military applications. Silicon Labs products shall under no circumstances be used in weapons of mass destruction including (but not limited to) nuclear, biological or chemical weapons, or missiles capable of delivering such weapons. Silicon Labs disclaims all express and implied warranties and shall not be responsible or liable for any injuries or damages related to use of a Silicon Labs product in such unauthorized applications.

Note: This content may contain offensive terminology that is now obsolete. Silicon Labs is replacing these terms with inclusive language wherever possible. For more information, visit www.silabs.com/about-us/inclusive-lexicon-project

Trademark Information

Silicon Laboratories Inc.[®], Silicon Laboratories[®], Silicon Labs[®], SiLabs[®] and the Silicon Labs logo[®], Bluegiga[®], Bluegiga Logo[®], EFM[®], EFM32[®], EFR, Ember[®], Energy Micro, Energy Micro logo and combinations thereof, "the world's most energy friendly microcontrollers", Redpine Signals[®], WiSeConnect, n-Link, ThreadArch[®], EZLink[®], EZRadio[®], EZRadioPRO[®], Gecko[®], Gecko OS, Gecko OS Studio, Precision32[®], Simplicity Studio[®], Telegesis, the Telegesis Logo[®], USBXpress[®], Zentri, the Zentri logo and Zentri DMS, Z-Wave[®], and others are trademarks or registered trademarks of Silicon Labs. ARM, CORTEX, Cortex-M3 and THUMB are trademarks or registered trademarks of ARM Holdings. Keil is a registered trademark of ARM Limited. Wi-Fi is a registered trademark of the Wi-Fi Alliance. All other products or brand names mentioned herein are trademarks of their respective holders.



Silicon Laboratories Inc.
400 West Cesar Chavez
Austin, TX 78701
USA

www.silabs.com