

EFM32 Giant Gecko Series 1 Family

EFM32GG12 Family Data Sheet



The EFM32 Giant Gecko Series 1 MCUs are the world's most energy-friendly microcontrollers, featuring new connectivity interfaces and user interface features.

EFM32GG12 includes a powerful 32-bit ARM® Cortex®-M4 and provides robust security via a unique cryptographic hardware engine supporting AES, ECC, SHA, and True Random Number Generator (TRNG). New features include an SD/MMC/SDIO controller, Octal/Quad-SPI memory controller, CAN bus controller, PDM interface, highly robust capacitive sensing, enhanced alpha blending graphics engine, and LESENSE/PCNT enhancements for smart energy meters. These features, combined with ultra-low current active mode and short wake-up time from energy-saving modes, make EFM32GG12 microcontrollers well suited for any battery-powered application, as well as other systems requiring high performance and low-energy consumption.

Example applications:

- Smart energy meters
- Industrial and factory automation
- Home automation and security
- Mid- and high-tier wearables
- IoT devices

- ARM Cortex-M4 at 72 MHz
- Ultra low energy operation
 - 76 μ A/MHz in Energy Mode 0 (EM0)
 - 1.8 μ A EM2 Deep Sleep current (RTCC running with state and RAM retention)
- Octal/Quad-SPI memory interface w/ XIP
- SD/MMC/SDIO Host Controller
- PDM Microphone/Sensor Interface
- Dual CAN 2.0 Bus Controller
- Crystal-free low-energy USB
- Hardware cryptographic engine supports AES, ECC, SHA, and TRNG
- Robust capacitive touch sense
- Footprint compatible with select EFM32 packages
- 5 V tolerant I/O



Lowest power mode with peripheral operational:

- EM0 - Active
- EM1 - Sleep
- EM2 - Deep Sleep
- EM3 - Stop
- EM4H - Hibernate
- EM4S - Shutoff

1. Feature List

The EFM32GG12 highlighted features are listed below.

- **ARM Cortex-M4 CPU Platform**
 - High performance 32-bit processor @ up to 72 MHz
 - DSP instruction support and Floating Point Unit
 - Memory Protection Unit
 - Wake-up Interrupt Controller
- **Flexible Energy Management System**
 - 76 μ A/MHz in Active Mode (EM0)
 - 1.8 μ A EM2 Deep Sleep current (16 kB RAM retention and RTCC running from LFRCO)
- **Integrated DC-DC Buck Converter**
- **Up to 1024 kB Flash Program Memory**
 - Dual-bank with read-while-write support
- **192 kB RAM Data Memory**
 - Includes ECC (SEC-DED)
- **Octal/Quad-SPI Flash Memory Interface**
 - Supports 3 V and 1.8 V memories
 - 1/2/4/8-bit data bus
 - Quad-SPI Execute In Place (XIP)
- **Communication Interfaces**
 - Low-energy Universal Serial Bus (USB) with Device and Host support
 - Fully USB 2.0 compliant
 - On-chip PHY and embedded 5 V to 3.3 V regulator
 - Crystal-free Device mode operation
 - Patent-pending Low-Energy Mode (LEM)
 - SD/MMC/SDIO Host Controller
 - SD v3.01, SDIO v3.0 and MMC v4.51
 - 1/4/8-bit bus width
 - Up to 2 \times CAN Bus Controller
 - Version 2.0A and 2.0B up to 1 Mbps
 - 5 \times Universal Synchronous/Asynchronous Receiver/Transmitter
 - UART/SPI/SmartCard (ISO 7816)/IrDA/I2S/LIN
 - Triple buffered full/half-duplex operation with flow control
 - Ultra high speed (36 MHz) operation on one instance
 - 2 \times Universal Asynchronous Receiver/Transmitter
 - 2 \times Low Energy UART
 - Autonomous operation with DMA in Deep Sleep Mode
 - 2 \times I²C Interface with SMBus support
 - Address recognition in EM3 Stop Mode
- **Up to 95 General Purpose I/O Pins**
 - Configurable push-pull, open-drain, pull-up/down, input filter, drive strength
 - Configurable peripheral I/O locations
 - 5 V tolerance on select pins
 - Asynchronous external interrupts
 - Output state retention and wake-up from Shutoff Mode
- **Up to 12 Channel DMA Controller**
- **Up to 16 Channel Peripheral Reflex System (PRS) for autonomous inter-peripheral signaling**
- **External Bus Interface for up to 4x256 MB of external memory mapped space**
 - TFT Controller with Direct Drive
 - Per-pixel alpha-blending engine
- **Hardware Cryptography**
 - AES 128/256-bit keys
 - ECC B/K163, B/K233, P192, P224, P256
 - SHA-1 and SHA-2 (SHA-224 and SHA-256)
 - True Random Number Generator (TRNG)
- **Hardware CRC Engine**
 - Single-cycle computation with 8/16/32-bit data and 16-bit (programmable)/32-bit (fixed) polynomial
- **Security Management Unit (SMU)**
 - Fine-grained access control for on-chip peripherals
- **Integrated Low-energy LCD Controller with up to 8 \times 36 segments**
 - Voltage boost, contrast and autonomous animation
 - Patented low-energy LCD driver
- **Backup Power Domain**
 - RTCC and retention registers in a separate power domain, available down to energy mode EM4H
 - Operation from backup battery when main power absent/insufficient
- **Ultra Low-Power Precision Analog Peripherals**
 - 2 \times 12-bit 1 Msamples/s Analog to Digital Converter (ADC)
 - On-chip temperature sensor
 - 2 \times 12-bit 500 ksamples/s Digital to Analog Converter (VDAC)
 - Digital to Analog Current Converter (IDAC)
 - Up to 3 \times Analog Comparator (ACMP)
 - Up to 4 \times Operational Amplifier (OPAMP)
 - Robust current-based capacitive sensing with wake-on-touch (CSEN)
 - Up to 83 GPIO pins are analog-capable. Flexible analog peripheral-to-pin routing via Analog Port (APORT)
 - Supply Voltage Monitor

- **Timers/Counters**
 - 4× 16-bit Timer/Counter
 - 3 or 4 Compare/Capture/PWM channels
 - Dead-Time Insertion on two timer instances
 - 2× 32-bit Timer/Counter
 - 3 or 4 Compare/Capture/PWM channels
 - Dead-Time Insertion on one timer instance
 - 32-bit Real Time Counter and Calendar (RTCC)
 - 24-bit Real Time Counter (RTC)
 - 32-bit Ultra Low Energy CRYOTIMER for periodic wakeup from any Energy Mode
 - 2× 16-bit Low Energy Timer for waveform generation
 - 3× 16-bit Pulse Counter with asynchronous operation
 - 2× Watchdog Timer with dedicated RC oscillator
- **Low Energy Sensor Interface (LESENSE)**
 - Autonomous sensor monitoring in Deep Sleep Mode
 - Wide range of sensors supported, including LC sensors and capacitive buttons
 - Up to 16 inputs
- **Ultra Efficient Power-on Reset and Brown-Out Detector**
- **Debug Interface**
 - 2-pin Serial Wire Debug interface
 - 1-pin Serial Wire Viewer
 - 4-pin JTAG interface
 - Embedded Trace Macrocell (ETM)
- **Pre-Programmed Bootloader**
- **Wide Operating Range**
 - 1.8 V to 3.8 V single power supply
 - Integrated DC-DC, down to 1.8 V output with up to 200 mA load current for system
 - Standard (-40 °C to 85 °C T_{AMB}) and Extended (-40 °C to 125 °C T_J) temperature grades available
- **Packages**
 - QFN64 (9x9 mm)
 - TQFP64 (10x10 mm)
 - TQFP100 (14x14 mm)
 - BGA112 (10x10 mm)
 - BGA120 (7x7 mm)

2. Ordering Information

Table 2.1. Ordering Information

Ordering Code	Flash (kB)	RAM (kB)	DC-DC Converter	USB	QSPI	SDIO	LCD	GPIO	Package	Temp Range
EFM32GG12B810F1024GL120-A	1024	192	Yes	Yes	Yes	Yes	Yes	95	BGA120	-40 to +85°C
EFM32GG12B810F1024IL120-A	1024	192	Yes	Yes	Yes	Yes	Yes	95	BGA120	-40 to +125°C
EFM32GG12B830F512GL120-A	512	192	Yes	Yes	Yes	Yes	Yes	95	BGA120	-40 to +85°C
EFM32GG12B830F512IL120-A	512	192	Yes	Yes	Yes	Yes	Yes	95	BGA120	-40 to +125°C
EFM32GG12B810F1024GL112-A	1024	192	Yes	Yes	Yes	Yes	Yes	89	BGA112	-40 to +85°C
EFM32GG12B810F1024IL112-A	1024	192	Yes	Yes	Yes	Yes	Yes	89	BGA112	-40 to +125°C
EFM32GG12B830F512GL112-A	512	192	Yes	Yes	Yes	Yes	Yes	89	BGA112	-40 to +85°C
EFM32GG12B830F512IL112-A	512	192	Yes	Yes	Yes	Yes	Yes	89	BGA112	-40 to +125°C
EFM32GG12B810F1024GQ100-A	1024	192	Yes	Yes	Yes	Yes	Yes	81	QFP100	-40 to +85°C
EFM32GG12B810F1024IQ100-A	1024	192	Yes	Yes	Yes	Yes	Yes	81	QFP100	-40 to +125°C
EFM32GG12B830F512GQ100-A	512	192	Yes	Yes	Yes	Yes	Yes	81	QFP100	-40 to +85°C
EFM32GG12B830F512IQ100-A	512	192	Yes	Yes	Yes	Yes	Yes	81	QFP100	-40 to +125°C
EFM32GG12B810F1024GM64-A	1024	192	Yes	Yes	Yes	Yes	Yes	51	QFN64	-40 to +85°C
EFM32GG12B810F1024GQ64-A	1024	192	Yes	Yes	Yes	Yes	Yes	48	QFP64	-40 to +85°C
EFM32GG12B810F1024IM64-A	1024	192	Yes	Yes	Yes	Yes	Yes	51	QFN64	-40 to +125°C
EFM32GG12B810F1024IQ64-A	1024	192	Yes	Yes	Yes	Yes	Yes	48	QFP64	-40 to +125°C
EFM32GG12B830F512GM64-A	512	192	Yes	Yes	Yes	Yes	Yes	51	QFN64	-40 to +85°C
EFM32GG12B830F512GQ64-A	512	192	Yes	Yes	Yes	Yes	Yes	48	QFP64	-40 to +85°C
EFM32GG12B830F512IM64-A	512	192	Yes	Yes	Yes	Yes	Yes	51	QFN64	-40 to +125°C
EFM32GG12B830F512IQ64-A	512	192	Yes	Yes	Yes	Yes	Yes	48	QFP64	-40 to +125°C
EFM32GG12B510F1024GL120-A	1024	192	Yes	No	No	No	Yes	95	BGA120	-40 to +85°C
EFM32GG12B510F1024IL120-A	1024	192	Yes	No	No	No	Yes	95	BGA120	-40 to +125°C
EFM32GG12B530F512GL120-A	512	192	Yes	No	No	No	Yes	95	BGA120	-40 to +85°C
EFM32GG12B530F512IL120-A	512	192	Yes	No	No	No	Yes	95	BGA120	-40 to +125°C
EFM32GG12B510F1024GL112-A	1024	192	Yes	No	No	No	Yes	92	BGA112	-40 to +85°C
EFM32GG12B510F1024IL112-A	1024	192	Yes	No	No	No	Yes	92	BGA112	-40 to +125°C
EFM32GG12B530F512GL112-A	512	192	Yes	No	No	No	Yes	92	BGA112	-40 to +85°C
EFM32GG12B530F512IL112-A	512	192	Yes	No	No	No	Yes	92	BGA112	-40 to +125°C
EFM32GG12B510F1024GQ100-A	1024	192	Yes	No	No	No	Yes	81	QFP100	-40 to +85°C
EFM32GG12B510F1024IQ100-A	1024	192	Yes	No	No	No	Yes	81	QFP100	-40 to +125°C

Ordering Code	Flash (kB)	RAM (kB)	DC-DC Converter	USB	QSPI	SDIO	LCD	GPIO	Package	Temp Range
EFM32GG12B530F512GQ100-A	512	192	Yes	No	No	No	Yes	81	QFP100	-40 to +85°C
EFM32GG12B530F512IQ100-A	512	192	Yes	No	No	No	Yes	81	QFP100	-40 to +125°C
EFM32GG12B510F1024GM64-A	1024	192	Yes	No	No	No	Yes	54	QFN64	-40 to +85°C
EFM32GG12B510F1024GQ64-A	1024	192	Yes	No	No	No	Yes	51	QFP64	-40 to +85°C
EFM32GG12B510F1024IM64-A	1024	192	Yes	No	No	No	Yes	54	QFN64	-40 to +125°C
EFM32GG12B510F1024IQ64-A	1024	192	Yes	No	No	No	Yes	51	QFP64	-40 to +125°C
EFM32GG12B530F512GM64-A	512	192	Yes	No	No	No	Yes	54	QFN64	-40 to +85°C
EFM32GG12B530F512GQ64-A	512	192	Yes	No	No	No	Yes	51	QFP64	-40 to +85°C
EFM32GG12B530F512IM64-A	512	192	Yes	No	No	No	Yes	54	QFN64	-40 to +125°C
EFM32GG12B530F512IQ64-A	512	192	Yes	No	No	No	Yes	51	QFP64	-40 to +125°C
EFM32GG12B410F1024GL120-A	1024	192	No	Yes	Yes	Yes	Yes	93	BGA120	-40 to +85°C
EFM32GG12B410F1024IL120-A	1024	192	No	Yes	Yes	Yes	Yes	93	BGA120	-40 to +125°C
EFM32GG12B430F512GL120-A	512	192	No	Yes	Yes	Yes	Yes	93	BGA120	-40 to +85°C
EFM32GG12B430F512IL120-A	512	192	No	Yes	Yes	Yes	Yes	93	BGA120	-40 to +125°C
EFM32GG12B410F1024GL112-A	1024	192	No	Yes	Yes	Yes	Yes	87	BGA112	-40 to +85°C
EFM32GG12B410F1024IL112-A	1024	192	No	Yes	Yes	Yes	Yes	87	BGA112	-40 to +125°C
EFM32GG12B430F512GL112-A	512	192	No	Yes	Yes	Yes	Yes	87	BGA112	-40 to +85°C
EFM32GG12B430F512IL112-A	512	192	No	Yes	Yes	Yes	Yes	87	BGA112	-40 to +125°C
EFM32GG12B410F1024GQ100-A	1024	192	No	Yes	Yes	Yes	Yes	83	QFP100	-40 to +85°C
EFM32GG12B410F1024IQ100-A	1024	192	No	Yes	Yes	Yes	Yes	83	QFP100	-40 to +125°C
EFM32GG12B430F512GQ100-A	512	192	No	Yes	Yes	Yes	Yes	83	QFP100	-40 to +85°C
EFM32GG12B430F512IQ100-A	512	192	No	Yes	Yes	Yes	Yes	83	QFP100	-40 to +125°C
EFM32GG12B410F1024GM64-A	1024	192	No	Yes	Yes	Yes	Yes	53	QFN64	-40 to +85°C
EFM32GG12B410F1024GQ64-A	1024	192	No	Yes	Yes	Yes	Yes	50	QFP64	-40 to +85°C
EFM32GG12B410F1024IM64-A	1024	192	No	Yes	Yes	Yes	Yes	53	QFN64	-40 to +125°C
EFM32GG12B410F1024IQ64-A	1024	192	No	Yes	Yes	Yes	Yes	50	QFP64	-40 to +125°C
EFM32GG12B430F512GM64-A	512	192	No	Yes	Yes	Yes	Yes	53	QFN64	-40 to +85°C
EFM32GG12B430F512GQ64-A	512	192	No	Yes	Yes	Yes	Yes	50	QFP64	-40 to +85°C
EFM32GG12B430F512IM64-A	512	192	No	Yes	Yes	Yes	Yes	53	QFN64	-40 to +125°C
EFM32GG12B430F512IQ64-A	512	192	No	Yes	Yes	Yes	Yes	50	QFP64	-40 to +125°C
EFM32GG12B310F1024GL112-A	1024	192	No	No	No	No	Yes	90	BGA112	-40 to +85°C
EFM32GG12B330F512GL112-A	512	192	No	No	No	No	Yes	90	BGA112	-40 to +85°C
EFM32GG12B310F1024GQ100-A	1024	192	No	No	No	No	Yes	86	QFP100	-40 to +85°C
EFM32GG12B330F512GQ100-A	512	192	No	No	No	No	Yes	86	QFP100	-40 to +85°C

Ordering Code	Flash (kB)	RAM (kB)	DC-DC Converter	USB	QSPI	SDIO	LCD	GPIO	Package	Temp Range
EFM32GG12B110F1024GM64-A	1024	192	No	No	No	No	No	56	QFN64	-40 to +85°C
EFM32GG12B110F1024GQ64-A	1024	192	No	No	No	No	No	53	QFP64	-40 to +85°C
EFM32GG12B110F1024IM64-A	1024	192	No	No	No	No	No	56	QFN64	-40 to +125°C
EFM32GG12B110F1024IQ64-A	1024	192	No	No	No	No	No	53	QFP64	-40 to +125°C
EFM32GG12B130F512GM64-A	512	192	No	No	No	No	No	56	QFN64	-40 to +85°C
EFM32GG12B130F512GQ64-A	512	192	No	No	No	No	No	53	QFP64	-40 to +85°C
EFM32GG12B130F512IM64-A	512	192	No	No	No	No	No	56	QFN64	-40 to +125°C
EFM32GG12B130F512IQ64-A	512	192	No	No	No	No	No	53	QFP64	-40 to +125°C



Figure 2.1. Ordering Code Key

Table of Contents

1. Feature List	2
2. Ordering Information	4
3. System Overview	11
3.1 Introduction	11
3.2 Power	12
3.2.1 Energy Management Unit (EMU)	12
3.2.2 DC-DC Converter	12
3.2.3 5 V Regulator	12
3.2.4 EM2 and EM3 Power Domains	13
3.3 General Purpose Input/Output (GPIO)	13
3.4 Clocking	13
3.4.1 Clock Management Unit (CMU)	13
3.4.2 Internal and External Oscillators	14
3.5 Counters/Timers and PWM	14
3.5.1 Timer/Counter (TIMER)	14
3.5.2 Wide Timer/Counter (WTIMER)	14
3.5.3 Real Time Counter and Calendar (RTCC)	14
3.5.4 Low Energy Timer (LETIMER)	14
3.5.5 Ultra Low Power Wake-up Timer (CRYOTIMER)	14
3.5.6 Pulse Counter (PCNT)	15
3.5.7 Watchdog Timer (WDOG)	15
3.6 Communications and Other Digital Peripherals	15
3.6.1 Universal Synchronous/Asynchronous Receiver/Transmitter (USART)	15
3.6.2 Universal Asynchronous Receiver/Transmitter (UART)	15
3.6.3 Low Energy Universal Asynchronous Receiver/Transmitter (LEUART)	15
3.6.4 Inter-Integrated Circuit Interface (I ² C)	15
3.6.5 External Bus Interface (EBI)	15
3.6.6 Quad-SPI Flash Controller (QSPI)	16
3.6.7 SDIO Host Controller (SDIO)	16
3.6.8 Universal Serial Bus (USB)	16
3.6.9 Controller Area Network (CAN)	16
3.6.10 Peripheral Reflex System (PRS)	16
3.6.11 Low Energy Sensor Interface (LESENSE)	16
3.6.12 Pulse Density Modulation (PDM) Interface	16
3.7 Security Features	17
3.7.1 General Purpose Cyclic Redundancy Check (GPCRC)	17
3.7.2 Crypto Accelerator (CRYPTO)	17
3.7.3 True Random Number Generator (TRNG)	17
3.7.4 Security Management Unit (SMU)	17
3.8 Analog	17
3.8.1 Analog Port (APORT)	17
3.8.2 Analog Comparator (ACMP)	17
3.8.3 Analog to Digital Converter (ADC)	17

3.8.4	Capacitive Sense (CSEN)	.18
3.8.5	Digital to Analog Current Converter (IDAC)	.18
3.8.6	Digital to Analog Converter (VDAC)	.18
3.8.7	Operational Amplifiers	.18
3.8.8	Liquid Crystal Display Driver (LCD)	.18
3.9	Reset Management Unit (RMU)	.18
3.10	Core and Memory	.18
3.10.1	Processor Core	.18
3.10.2	Memory System Controller (MSC)	.19
3.10.3	Linked Direct Memory Access Controller (LDMA)	.19
3.10.4	Bootloader	.19
3.11	Memory Map	.20
3.12	Configuration Summary	.22
4.	Electrical Specifications	.23
4.1	Electrical Characteristics	.23
4.1.1	Absolute Maximum Ratings	.24
4.1.2	Operating Conditions	.25
4.1.3	Thermal Characteristics	.27
4.1.4	DC-DC Converter	.28
4.1.5	5V Regulator	.30
4.1.6	Backup Supply Domain	.31
4.1.7	Current Consumption	.32
4.1.8	Wake Up Times	.39
4.1.9	Brown Out Detector (BOD)	.40
4.1.10	Oscillators	.41
4.1.11	Flash Memory Characteristics	.48
4.1.12	General-Purpose I/O (GPIO)	.49
4.1.13	Voltage Monitor (VMON)	.51
4.1.14	Analog to Digital Converter (ADC)	.52
4.1.15	Analog Comparator (ACMP)	.54
4.1.16	Digital to Analog Converter (VDAC)	.57
4.1.17	Current Digital to Analog Converter (IDAC)	.60
4.1.18	Capacitive Sense (CSEN)	.62
4.1.19	Operational Amplifier (OPAMP)	.64
4.1.20	LCD Driver	.67
4.1.21	Pulse Counter (PCNT)	.68
4.1.22	Analog Port (APORT)	.68
4.1.23	I2C	.69
4.1.24	USART SPI	.72
4.1.25	External Bus Interface (EBI)	.75
4.1.26	Serial Data I/O Host Controller (SDIO)	.84
4.1.27	Quad SPI (QSPI)	.103
4.1.28	PDM	.108
4.2	Typical Performance Curves	.108
4.2.1	Supply Current	.109
4.2.2	DC-DC Converter	.115

5. Pin Definitions	117
5.1 EFM32GG12B8xx in BGA120 Device Pinout	117
5.2 EFM32GG12B5xx in BGA120 Device Pinout	120
5.3 EFM32GG12B4xx in BGA120 Device Pinout	123
5.4 EFM32GG12B8xx in BGA112 Device Pinout	126
5.5 EFM32GG12B5xx in BGA112 Device Pinout	129
5.6 EFM32GG12B4xx in BGA112 Device Pinout	132
5.7 EFM32GG12B3xx in BGA112 Device Pinout	135
5.8 EFM32GG12B8xx in QFP100 Device Pinout	138
5.9 EFM32GG12B5xx in QFP100 Device Pinout	141
5.10 EFM32GG12B4xx in QFP100 Device Pinout	144
5.11 EFM32GG12B3xx in QFP100 Device Pinout	147
5.12 EFM32GG12B8xx in QFP64 Device Pinout	150
5.13 EFM32GG12B5xx in QFP64 Device Pinout	152
5.14 EFM32GG12B4xx in QFP64 Device Pinout	154
5.15 EFM32GG12B1xx in QFP64 Device Pinout	156
5.16 EFM32GG12B8xx in QFN64 Device Pinout	158
5.17 EFM32GG12B5xx in QFN64 Device Pinout	160
5.18 EFM32GG12B4xx in QFN64 Device Pinout	162
5.19 EFM32GG12B1xx in QFN64 Device Pinout	164
5.20 GPIO Functionality Table	166
5.21 Alternate Functionality Overview	178
5.22 Analog Port (APORT) Client Maps	204
6. BGA120 Package Specifications	216
6.1 BGA120 Package Dimensions	216
6.2 BGA120 PCB Land Pattern	218
6.3 BGA120 Package Marking	220
7. BGA112 Package Specifications	221
7.1 BGA112 Package Dimensions	221
7.2 BGA112 PCB Land Pattern	223
7.3 BGA112 Package Marking	225
8. TQFP100 Package Specifications	226
8.1 TQFP100 Package Dimensions	226
8.2 TQFP100 PCB Land Pattern	228
8.3 TQFP100 Package Marking	229
9. TQFP64 Package Specifications	230
9.1 TQFP64 Package Dimensions	230

9.2 TQFP64 PCB Land Pattern	232
9.3 TQFP64 Package Marking	233
10. QFN64 Package Specifications234
10.1 QFN64 Package Dimensions.	234
10.2 QFN64 PCB Land Pattern.	236
10.3 QFN64 Package Marking	238
11. Revision History.	239

3. System Overview

3.1 Introduction

The Giant Gecko Series 1 product family is well suited for any battery operated application as well as other systems requiring high performance and low energy consumption. This section gives a short introduction to the MCU system. The detailed functional description can be found in the Giant Gecko Series 1 Reference Manual.

A block diagram of the Giant Gecko Series 1 family is shown in [Figure 3.1 Detailed EFM32GG12 Block Diagram on page 11](#). The diagram shows a superset of features available on the family, which vary by OPN. For more information about specific device features, consult [Ordering Information](#).

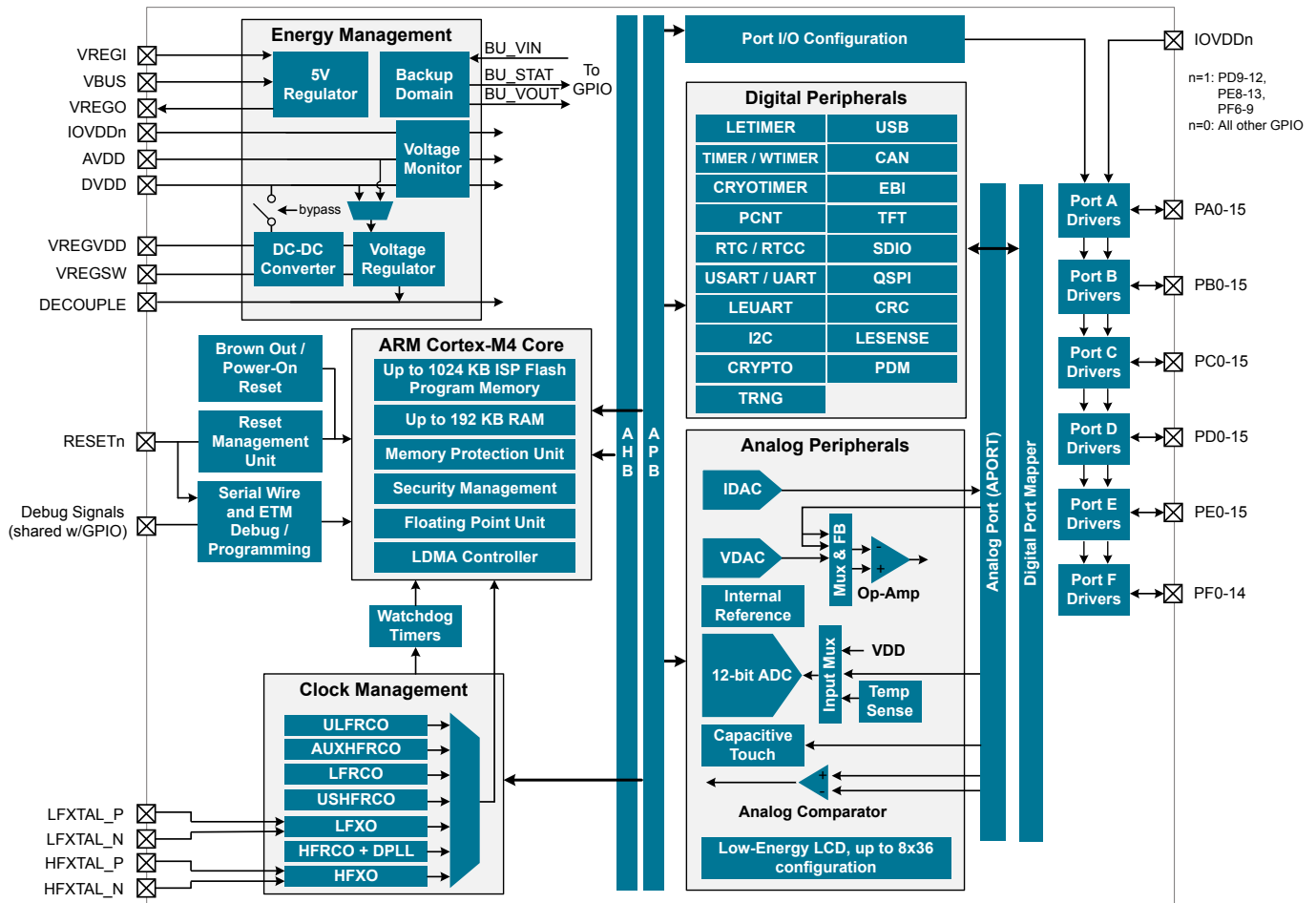

Figure 3.1. Detailed EFM32GG12 Block Diagram

3.2 Power

The EFM32GG12 has an Energy Management Unit (EMU) and efficient integrated regulators to generate internal supply voltages. Only a single external supply voltage is required, from which all internal voltages are created. A 5 V regulator is available on some OPNs, allowing the device to be powered directly from 5 V power sources, such as USB. An optional integrated DC-DC buck regulator can be utilized to further reduce the current consumption. The DC-DC regulator requires one external inductor and one external capacitor.

The EFM32GG12 device family includes support for internal supply voltage scaling, as well as two different power domain groups for peripherals. These enhancements allow for further supply current reductions and lower overall power consumption.

AVDD and VREGVDD need to be 1.8 V or higher for the MCU to operate across all conditions; however the rest of the system will operate down to 1.62 V, including the digital supply and I/O. This means that the device is fully compatible with 1.8 V components. Running from a sufficiently high supply, the device can use the DC-DC to regulate voltage not only for itself, but also for other PCB components, supplying up to a total of 200 mA.

3.2.1 Energy Management Unit (EMU)

The Energy Management Unit manages transitions of energy modes in the device. Each energy mode defines which peripherals and features are available and the amount of current the device consumes. The EMU can also be used to turn off the power to unused RAM blocks, and it contains control registers for the DC-DC regulator and the Voltage Monitor (VMON). The VMON is used to monitor multiple supply voltages. It has multiple channels which can be programmed individually by the user to determine if a sensed supply has fallen below a chosen threshold.

3.2.2 DC-DC Converter

The DC-DC buck converter covers a wide range of load currents and provides up to 90% efficiency in energy modes EM0, EM1, EM2 and EM3, and can supply up to 200 mA to the device and surrounding PCB components. Protection features include programmable current limiting, short-circuit protection, and dead-time protection. The DC-DC converter may also enter bypass mode when the input voltage is too low for efficient operation. In bypass mode, the DC-DC input supply is internally connected directly to its output through a low resistance switch. Bypass mode also supports in-rush current limiting to prevent input supply voltage droops due to excessive output current transients.

3.2.3 5 V Regulator

A 5 V input regulator is available, allowing the device to be powered directly from 5 V power sources such as the USB VBUS line. The regulator is available in all energy modes, and outputs 3.3 V to be used to power the USB PHY and other 3.3 V systems. Two inputs to the regulator allow for seamless switching between local and external power sources.

3.2.4 EM2 and EM3 Power Domains

The EFM32GG12 has three independent peripheral power domains for use in EM2 and EM3. Two of these domains are dynamic and can be shut down to save energy. Peripherals associated with the two dynamic power domains are listed in [Table 3.1 EM2 and EM3 Peripheral Power Subdomains on page 13](#). If all of the peripherals in a peripheral power domain are unused, the power domain for that group will be powered off in EM2 and EM3, reducing the overall current consumption of the device. Other EM2, EM3, and EM4-capable peripherals and functions not listed in the table below reside on the primary power domain, which is always on in EM2 and EM3.

Table 3.1. EM2 and EM3 Peripheral Power Subdomains

Peripheral Power Domain 1	Peripheral Power Domain 2
ACMP0	ACMP1
PCNT0	PCNT1
ADC0	PCNT2
LETIMER0	CSEN
LESENSE	VDAC0
APOINT	LEUART0
-	LEUART1
-	LETIMER1
-	I2C0
-	I2C1
-	IDAC
-	ADC1
-	ACMP2
-	LCD
-	RTC

3.3 General Purpose Input/Output (GPIO)

EFM32GG12 has up to 95 General Purpose Input/Output pins. GPIO are organized on three independent supply rails, allowing for interface to multiple logic levels in the system simultaneously. Each GPIO pin can be individually configured as either an output or input. More advanced configurations including open-drain, open-source, and glitch-filtering can be configured for each individual GPIO pin. The GPIO pins can be overridden by peripheral connections, like SPI communication. Each peripheral connection can be routed to several GPIO pins on the device. The input value of a GPIO pin can be routed through the Peripheral Reflex System to other peripherals. The GPIO subsystem supports asynchronous external pin interrupts.

3.4 Clocking

3.4.1 Clock Management Unit (CMU)

The Clock Management Unit controls oscillators and clocks in the EFM32GG12. Individual enabling and disabling of clocks to all peripherals is performed by the CMU. The CMU also controls enabling and configuration of the oscillators. A high degree of flexibility allows software to optimize energy consumption in any specific application by minimizing power dissipation in unused peripherals and oscillators.

3.4.2 Internal and External Oscillators

The EFM32GG12 supports two crystal oscillators and fully integrates five RC oscillators, listed below.

- A high frequency crystal oscillator (HFXO) with integrated load capacitors, tunable in small steps, provides a precise timing reference for the MCU. Crystal frequencies in the range from 4 to 50 MHz are supported. An external clock source such as a TCXO can also be applied to the HFXO input for improved accuracy over temperature.
- A 32.768 kHz crystal oscillator (LFXO) provides an accurate timing reference for low energy modes.
- An integrated high frequency RC oscillator (HFRCO) is available for the MCU system. The HFRCO employs fast startup at minimal energy consumption combined with a wide frequency range. When crystal accuracy is not required, it can be operated in free-running mode at a number of factory-calibrated frequencies. A digital phase-locked loop (DPLL) feature allows the HFRCO to achieve higher accuracy and stability by referencing other available clock sources such as LFXO and HFXO.
- An integrated auxiliary high frequency RC oscillator (AUXHFRCO) is available for timing the general-purpose ADC and the Serial Wire Viewer port with a wide frequency range.
- An integrated universal high frequency RC oscillator (USHFRCO) is available for timing the USB, SDIO and QSPI peripherals. The USHFRCO can be synchronized to the host's USB clock to allow the USB to operate in device mode without the additional cost of an external crystal.
- An integrated low frequency 32.768 kHz RC oscillator (LFRCO) can be used as a timing reference in low energy modes, when crystal accuracy is not required.
- An integrated ultra-low frequency 1 kHz RC oscillator (ULFRCO) is available to provide a timing reference at the lowest energy consumption in low energy modes.

3.5 Counters/Timers and PWM

3.5.1 Timer/Counter (TIMER)

TIMER peripherals keep track of timing, count events, generate PWM outputs and trigger timed actions in other peripherals through the PRS system. The core of each TIMER is a 16-bit counter with up to 4 compare/capture channels. Each channel is configurable in one of three modes. In capture mode, the counter state is stored in a buffer at a selected input event. In compare mode, the channel output reflects the comparison of the counter to a programmed threshold value. In PWM mode, the TIMER supports generation of pulse-width modulation (PWM) outputs of arbitrary waveforms defined by the sequence of values written to the compare registers, with optional dead-time insertion available in timer unit TIMER_0 only.

3.5.2 Wide Timer/Counter (WTIMER)

WTIMER peripherals function just as TIMER peripherals, but are 32 bits wide. They keep track of timing, count events, generate PWM outputs and trigger timed actions in other peripherals through the PRS system. The core of each WTIMER is a 32-bit counter with up to 4 compare/capture channels. Each channel is configurable in one of three modes. In capture mode, the counter state is stored in a buffer at a selected input event. In compare mode, the channel output reflects the comparison of the counter to a programmed threshold value. In PWM mode, the WTIMER supports generation of pulse-width modulation (PWM) outputs of arbitrary waveforms defined by the sequence of values written to the compare registers, with optional dead-time insertion available in timer unit WTIMER_0 only.

3.5.3 Real Time Counter and Calendar (RTCC)

The Real Time Counter and Calendar (RTCC) is a 32-bit counter providing timekeeping in all energy modes. The RTCC includes a Binary Coded Decimal (BCD) calendar mode for easy time and date keeping. The RTCC can be clocked by any of the on-board oscillators with the exception of the AUXHFRCO, and it is capable of providing system wake-up at user defined instances. The RTCC includes 128 bytes of general purpose data retention, allowing easy and convenient data storage in all energy modes down to EM4H.

3.5.4 Low Energy Timer (LETIMER)

The unique LETIMER is a 16-bit timer that is available in energy mode EM2 Deep Sleep in addition to EM1 Sleep and EM0 Active. This allows it to be used for timing and output generation when most of the device is powered down, allowing simple tasks to be performed while the power consumption of the system is kept at an absolute minimum. The LETIMER can be used to output a variety of waveforms with minimal software intervention. The LETIMER is connected to the Real Time Counter and Calendar (RTCC), and can be configured to start counting on compare matches from the RTCC.

3.5.5 Ultra Low Power Wake-up Timer (CRYOTIMER)

The CRYOTIMER is a 32-bit counter that is capable of running in all energy modes. It can be clocked by either the 32.768 kHz crystal oscillator (LFXO), the 32.768 kHz RC oscillator (LFRCO), or the 1 kHz RC oscillator (ULFRCO). It can provide periodic Wakeup events and PRS signals which can be used to wake up peripherals from any energy mode. The CRYOTIMER provides a wide range of interrupt periods, facilitating flexible ultra-low energy operation.

3.5.6 Pulse Counter (PCNT)

The Pulse Counter (PCNT) peripheral can be used for counting pulses on a single input or to decode quadrature encoded inputs. The clock for PCNT is selectable from either an external source on pin PCTNn_S0IN or from an internal timing reference, selectable from among any of the internal oscillators, except the AUXHFRCO. The peripheral may operate in energy mode EM0 Active, EM1 Sleep, EM2 Deep Sleep, and EM3 Stop.

3.5.7 Watchdog Timer (WDOG)

The watchdog timer can act both as an independent watchdog or as a watchdog synchronous with the CPU clock. It has windowed monitoring capabilities, and can generate a reset or different interrupts depending on the failure mode of the system. The watchdog can also monitor autonomous systems driven by PRS.

3.6 Communications and Other Digital Peripherals

3.6.1 Universal Synchronous/Asynchronous Receiver/Transmitter (USART)

The Universal Synchronous/Asynchronous Receiver/Transmitter is a flexible serial I/O interface. It supports full duplex asynchronous UART communication with hardware flow control as well as RS-485, SPI, MicroWire and 3-wire. It can also interface with devices supporting:

- ISO7816 SmartCards
- IrDA
- I²S

3.6.2 Universal Asynchronous Receiver/Transmitter (UART)

The Universal Asynchronous Receiver/Transmitter is a subset of the USART peripheral, supporting full duplex asynchronous UART communication with hardware flow control and RS-485.

3.6.3 Low Energy Universal Asynchronous Receiver/Transmitter (LEUART)

The unique LEUART™ provides two-way UART communication on a strict power budget. Only a 32.768 kHz clock is needed to allow UART communication up to 9600 baud. The LEUART includes all necessary hardware to make asynchronous serial communication possible with a minimum of software intervention and energy consumption.

3.6.4 Inter-Integrated Circuit Interface (I²C)

The I²C interface enables communication between the MCU and a serial I²C bus. It is capable of acting as both a master and a slave and supports multi-master buses. Standard-mode, fast-mode and fast-mode plus speeds are supported, allowing transmission rates from 10 kbit/s up to 1 Mbit/s. Slave arbitration and timeouts are also available, allowing implementation of an SMBus-compliant system. The interface provided to software by the I²C peripheral allows precise timing control of the transmission process and highly automated transfers. Automatic recognition of slave addresses is provided in active and low energy modes.

3.6.5 External Bus Interface (EBI)

The External Bus Interface provides access to external parallel interface devices. The interface is memory mapped into the address bus of the Cortex-M4. This enables seamless access from software without manually manipulating the I/O settings each time a read or write is performed. The data and address lines are multiplexed in order to reduce the number of pins required to interface to external devices. Timing is adjustable to meet specifications of the external devices. The interface is limited to asynchronous devices.

The EBI contains a TFT controller which can drive a TFT via an RGB interface. The TFT controller supports programmable display and port sizes and offers accurate control of frequency and setup and hold timing. Direct Drive is supported for TFT displays which do not have their own frame buffer. In that case TFT Direct Drive can transfer data from either on-chip memory or from an external memory device to the TFT at low CPU load. Automatic alpha-blending and masking is also supported for transfers through the EBI interface.

3.6.6 Quad-SPI Flash Controller (QSPI)

The QSPI provides access to a wide range of flash devices with wide I/O busses. The I/O and clocking configuration is flexible and supports many types of devices. Up to 8-bit wide interfaces are supported. The QSPI handles opcodes, status flag polling, and timing configuration automatically.

The external flash memory is mapped directly to internal memory to allow random access to any word in the flash and direct code execution. An integrated instruction cache minimizes latency and allows efficient code execution. Execute in Place (XIP) is supported for devices with this feature.

Large data chunks can be transferred with DMA as efficiently as possible with high throughput and minimal bus load, utilizing an integrated 1 kB SRAM FIFO.

3.6.7 SDIO Host Controller (SDIO)

The SDIO is an SD3.01 / SDIO3.0 / eMMC4.51-compliant Host Controller interface for transferring data to and from SD/MMC/SDIO devices. The module conforms to the SD Host Controller Standard Specification Version 3.00. The Host Controller handles SDIO/SD/MMC Protocol at the transmission level, packing data, adding cyclic redundancy check (CRC), Start/End bits, and checking for transaction format correctness.

3.6.8 Universal Serial Bus (USB)

The USB is a full-speed/low-speed USB 2.0 compliant host/device controller. The USB can be used in device and host-only configurations, while a clock recovery mechanism allows crystal-less operation in device mode. The USB block supports both full speed (12 MBit/s) and low speed (1.5 MBit/s) operation. When operating as a device, a special Low Energy Mode ensures the current consumption is optimized, enabling USB communications on a strict power budget. The USB device includes an internal dedicated Descriptor-Based Scatter/Gather DMA and supports up to 6 OUT endpoints and 6 IN endpoints, in addition to endpoint 0. The on-chip PHY includes internal pull-up and pull-down resistors, as well as voltage comparators for monitoring the VBUS voltage and A/B device identification using the ID line.

3.6.9 Controller Area Network (CAN)

The CAN peripheral provides support for communication at up to 1 Mbps over CAN protocol version 2.0 part A and B. It includes 32 message objects with independent identifier masks and retains message RAM in EM2. Automatic retransmission may be disabled in order to support Time Triggered CAN applications.

3.6.10 Peripheral Reflex System (PRS)

The Peripheral Reflex System provides a communication network between different peripherals without software involvement. Peripherals producing Reflex signals are called producers. The PRS routes Reflex signals from producers to consumer peripherals, which in turn perform actions in response. Edge triggers and other functionality such as simple logic operations (AND, OR, NOT) can be applied by the PRS to the signals. The PRS allows peripheral to act autonomously without waking the MCU core, saving power.

3.6.11 Low Energy Sensor Interface (LESENSE)

The Low Energy Sensor Interface LESENSE™ is a highly configurable sensor interface with support for up to 16 individually configurable sensors. By controlling the analog comparators, ADC, and DAC, LESENSE is capable of supporting a wide range of sensors and measurement schemes, and can for instance measure LC sensors, resistive sensors and capacitive sensors. LESENSE also includes a programmable finite state machine which enables simple processing of measurement results without CPU intervention. LESENSE is available in energy mode EM2, in addition to EM0 and EM1, making it ideal for sensor monitoring in applications with a strict energy budget.

3.6.12 Pulse Density Modulation (PDM) Interface

The PDM module provides a serial interface and decimation filter for Pulse Density Modulation (PDM) microphones, isolated Sigma-delta ADCs, digital sensors and other PDM or sigma delta bit stream peripherals. A programmable Cascaded Integrator Comb (CIC) filter is used to decimate the incoming bit streams. PDM supports multiple channels of stereo or mono input data and DMA transfer.

3.7 Security Features

3.7.1 General Purpose Cyclic Redundancy Check (GPCRC)

The GPCRC block implements a Cyclic Redundancy Check (CRC) function. It supports both 32-bit and 16-bit polynomials. The supported 32-bit polynomial is 0x04C11DB7 (IEEE 802.3), while the 16-bit polynomial can be programmed to any value, depending on the needs of the application.

3.7.2 Crypto Accelerator (CRYPTO)

The Crypto Accelerator is a fast and energy-efficient autonomous hardware encryption and decryption accelerator. Giant Gecko Series 1 devices support AES encryption and decryption with 128- or 256-bit keys, ECC over both GF(P) and GF(2^m), and SHA-1 and SHA-2 (SHA-224 and SHA-256).

Supported block cipher modes of operation for AES include: ECB, CTR, CBC, PCBC, CFB, OFB, GCM, CBC-MAC, GMAC and CCM.

Supported ECC NIST recommended curves include P-192, P-224, P-256, K-163, K-233, B-163 and B-233.

The CRYPTO peripheral allows fast processing of GCM (AES), ECC and SHA with little CPU intervention. CRYPTO also provides trigger signals for DMA read and write operations.

3.7.3 True Random Number Generator (TRNG)

The TRNG is a non-deterministic random number generator based on a full hardware solution. The TRNG is validated with NIST800-22 and AIS-31 test suites as well as being suitable for FIPS 140-2 certification (for the purposes of cryptographic key generation).

3.7.4 Security Management Unit (SMU)

The Security Management Unit (SMU) allows software to set up fine-grained security for peripheral access, which is not possible in the Memory Protection Unit (MPU). Peripherals may be secured by hardware on an individual basis, such that only privileged accesses to the peripheral's register interface will be allowed. When an access fault occurs, the SMU reports the specific peripheral involved and can optionally generate an interrupt.

3.8 Analog

3.8.1 Analog Port (APORT)

The Analog Port (APORT) is an analog interconnect matrix allowing access to many analog peripherals on a flexible selection of pins. Each APORT bus consists of analog switches connected to a common wire. Since many clients can operate differentially, buses are grouped by X/Y pairs.

3.8.2 Analog Comparator (ACMP)

The Analog Comparator is used to compare the voltage of two analog inputs, with a digital output indicating which input voltage is higher. Inputs are selected from among internal references and external pins. The tradeoff between response time and current consumption is configurable by software. Two 6-bit reference dividers allow for a wide range of internally-programmable reference sources. The ACMP can also be used to monitor the supply voltage. An interrupt can be generated when the supply falls below or rises above the programmable threshold.

3.8.3 Analog to Digital Converter (ADC)

The ADC is a Successive Approximation Register (SAR) architecture, with a resolution of up to 12 bits at up to 1 Msps. The output sample resolution is configurable and additional resolution is possible using integrated hardware for averaging over multiple samples. The ADC includes integrated voltage references and an integrated temperature sensor. Inputs are selectable from a wide range of sources, including pins configurable as either single-ended or differential.

3.8.4 Capacitive Sense (CSEN)

The CSEN peripheral is a dedicated Capacitive Sensing block for implementing touch-sensitive user interface elements such as switches and sliders. The CSEN peripheral uses a charge ramping measurement technique, which provides robust sensing even in adverse conditions including radiated noise and moisture. The peripheral can be configured to take measurements on a single port pin or scan through multiple pins and store results to memory through DMA. Several channels can also be shorted together to measure the combined capacitance or implement wake-on-touch from very low energy modes. Hardware includes a digital accumulator and an averaging filter, as well as digital threshold comparators to reduce software overhead.

3.8.5 Digital to Analog Current Converter (IDAC)

The IDAC can source or sink a configurable constant current. This current can be driven on an output pin or routed to the selected ADC input pin for capacitive sensing. The full-scale current is programmable between 0.05 μA and 64 μA with several ranges consisting of various step sizes.

3.8.6 Digital to Analog Converter (VDAC)

The Digital to Analog Converter (VDAC) can convert a digital value to an analog output voltage. The VDAC is a fully differential, 500 ksp/s, 12-bit converter. The opamps are used in conjunction with the VDAC, to provide output buffering. One opamp is used per single-ended channel, or two opamps are used to provide differential outputs. The VDAC may be used for a number of different applications such as sensor interfaces or sound output. The VDAC can generate high-resolution analog signals while the MCU is operating at low frequencies and with low total power consumption. Using DMA and a timer, the VDAC can be used to generate waveforms without any CPU intervention. The VDAC is available in all energy modes down to and including EM3.

3.8.7 Operational Amplifiers

The opamps are low power amplifiers with a high degree of flexibility targeting a wide variety of standard opamp application areas, and are available down to EM3. With flexible built-in programming for gain and interconnection they can be configured to support multiple common opamp functions. All pins are also available externally for filter configurations. Each opamp has a rail to rail input and a rail to rail output. They can be used in conjunction with the VDAC peripheral or in stand-alone configurations. The opamps save energy, PCB space, and cost as compared with standalone opamps because they are integrated on-chip.

3.8.8 Liquid Crystal Display Driver (LCD)

The LCD driver is capable of driving a segmented LCD display with up to 8x36 segments. A voltage boost function enables it to provide the LCD display with higher voltage than the supply voltage for the device. A patented charge redistribution driver can reduce the LCD module supply current by up to 40%. In addition, an animation feature can run custom animations on the LCD display without any CPU intervention. The LCD driver can also remain active even in Energy Mode 2 and provides a Frame Counter interrupt that can wake-up the device on a regular basis for updating data.

3.9 Reset Management Unit (RMU)

The RMU is responsible for handling reset of the EFM32GG12. A wide range of reset sources are available, including several power supply monitors, pin reset, software controlled reset, core lockup reset, and watchdog reset.

3.10 Core and Memory

3.10.1 Processor Core

The ARM Cortex-M processor includes a 32-bit RISC processor integrating the following features and tasks in the system:

- ARM Cortex-M4 RISC processor with FPU achieving 1.25 Dhrystone MIPS/MHz
- Memory Protection Unit (MPU) supporting up to 8 memory segments
- Embedded Trace Macrocell (ETM) for real-time trace and debug
- Up to 1024 kB flash program memory
 - Dual-bank memory with read-while-write support
- Up to 192 kB RAM data memory
- Configuration and event handling of all modules
- 2-pin Serial-Wire or 4-pin JTAG debug interface

3.10.2 Memory System Controller (MSC)

The Memory System Controller (MSC) is the program memory unit of the microcontroller. The flash memory is readable and writable from both the Cortex-M and DMA. The flash memory is divided into two blocks; the main block and the information block. Program code is normally written to the main block, whereas the information block is available for special user data and flash lock bits. There is also a read-only page in the information block containing system and device calibration data. Read and write operations are supported in energy modes EM0 Active and EM1 Sleep.

3.10.3 Linked Direct Memory Access Controller (LDMA)

The Linked Direct Memory Access (LDMA) controller allows the system to perform memory operations independently of software. This reduces both energy consumption and software workload. The LDMA allows operations to be linked together and staged, enabling sophisticated operations to be implemented.

3.10.4 Bootloader

All devices come pre-programmed with a UART bootloader. This bootloader resides in flash and can be erased if it is not needed. More information about the bootloader protocol and usage can be found in *AN0003: UART Bootloader*. Application notes can be found on the Silicon Labs website (www.silabs.com/32bit-appnotes) or within Simplicity Studio in the [Documentation] area.

3.11 Memory Map

The EFM32GG12 memory map is shown in the figures below. RAM and flash sizes are for the largest memory configuration.



Figure 3.2. EFM32GG12 Memory Map — Core Peripherals and Code Space

0x40028000	PDM	0xfffffff	PRS	0x400e6000
0x40022400		0xe0100000	RMU	0x400e5400
0x40022000	USB	0xfffffff		0x400e5000
0x40020400		0x00000000	CMU	0x400e4400
0x40020000	SMU	0xc0000000		0x400e4000
0x4001d400		0xb0000000	EMU	0x400e3400
0x4001d000	TRNG0	0x80000000		0x400e3000
0x4001c800		0x80000000	CRYOTIMER	0x4008f000
0x4001c400	QSPI0	0x80000000		0x4008e400
0x4001c000	GPCRC	0x80000000	CSEN	0x4008e000
0x4001a800		0x80000000		0x40089800
0x4001a400	WTIMER1	0x460f03ff	IZC1	0x40089400
0x4001a000	WTIMER0	0x460f03ff	IZC0	0x40088000
0x40019000		0x460f03ff	GPIO	0x40087000
0x40018c00	TIMER3	0x440f03ff	VDAC0	0x40086400
0x40018800	TIMER2	0x440f03ff	IDAC0	0x40084400
0x40018400	TIMER1	0x43110000		0x40084000
0x40018000	TIMER0	0x43110000	ADC1	0x40082800
0x40014800		0x43e3ffff	ADC0	0x40082400
0x40014400	UART1	0x42000000		0x40082000
0x40014000	UART0	0x42110000	ACMP2	0x40080c00
0x40011400		0x4013ffff	ACMP1	0x40080800
0x40011000	USART4	0x40100000	ACMP0	0x40080400
0x40010c00	USART3	0x400f03ff		0x40080000
0x40010800	USART2	0x400f03ff	PCNT2	0x4006ec00
0x40010400	USART1	0x400f03ff	PCNT1	0x4006e800
0x40010000	USART0	0x400f03ff	PCNT0	0x4006e400
0x4000b400		0x400f03ff		0x4006e000
0x4000b000	EBI	0x400f03ff	LEUART1	0x4006a800
0x40004800		0x400f03ff	LEUART0	0x4006a400
0x40004400	CAN1	0x400f03ff		0x4006a000
0x40004000	CAN0	0x400f03ff	LETIMER1	0x40068000
0x40003000		0x400f03ff	LETIMER0	0x40066400
0x40002000	LDMA	0x31000000		0x40066000
0x40001400		0x237fffff	RTCC	0x40062400
0x40001000	FPUEH	0x22000000		0x40062000
0x40000800		0x2211ffff	RTC	0x40060400
0x40000000	MSC	0x20030000		0x40060000
		0x20020000	LESENSE	0x40055400
		0x20010000		0x40055000
		0x20000000	LCD	0x40054400
		0x1fffffff		0x40054000
		0x00000000	WDOG1	0x40052800
			WDOG0	0x40052400
				0x40052000

Figure 3.3. EFM32GG12 Memory Map — Peripherals

3.12 Configuration Summary

The features of the EFM32GG12 are a subset of the feature set described in the device reference manual. The table below describes device specific implementation of the features. Remaining peripherals support full configuration.

Table 3.2. Configuration Summary

Module	Configuration	Pin Connections
USART0	IrDA, SmartCard	US0_TX, US0_RX, US0_CLK, US0_CS
USART1	I ² S, SmartCard	US1_TX, US1_RX, US1_CLK, US1_CS
USART2	IrDA, SmartCard, High-Speed	US2_TX, US2_RX, US2_CLK, US2_CS
USART3	I ² S, SmartCard	US3_TX, US3_RX, US3_CLK, US3_CS
USART4	I ² S, SmartCard	US4_TX, US4_RX, US4_CLK, US4_CS
TIMER0	with DTI	TIM0_CC[2:0], TIM0_CDTI[2:0]
TIMER1	-	TIM1_CC[3:0]
TIMER2	with DTI	TIM2_CC[2:0], TIM2_CDTI[2:0]
TIMER3	-	TIM3_CC[2:0]
WTIMER0	with DTI	WTIM0_CC[2:0], WTIM0_CDTI[2:0]
WTIMER1	-	WTIM1_CC[3:0]

4. Electrical Specifications

4.1 Electrical Characteristics

All electrical parameters in all tables are specified under the following conditions, unless stated otherwise:

- Typical values are based on $T_{AMB}=25\text{ }^{\circ}\text{C}$ and $V_{DD}=3.3\text{ V}$, by production test and/or technology characterization.
- Minimum and maximum values represent the worst conditions across supply voltage, process variation, and operating temperature, unless stated otherwise.

Refer to [4.1.2.1 General Operating Conditions](#) for more details about operational supply and temperature limits.

4.1.1 Absolute Maximum Ratings

Stresses above those listed below may cause permanent damage to the device. This is a stress rating only and functional operation of the devices at those or any other conditions above those indicated in the operation listings of this specification is not implied. Exposure to maximum rating conditions for extended periods may affect device reliability. For more information on the available quality and reliability data, see the Quality and Reliability Monitor Report at <http://www.silabs.com/support/quality/pages/default.aspx>.

Table 4.1. Absolute Maximum Ratings

Parameter	Symbol	Test Condition	Min	Typ	Max	Unit
Storage temperature range	T _{STG}		-50	—	150	°C
Voltage on supply pins other than VREGI and VBUS	V _{DDMAX}		-0.3	—	3.8	V
Voltage ramp rate on any supply pin	V _{DDRAMPMAX}		—	—	1	V / μs
DC voltage on any GPIO pin	V _{DIGPIN}	5V tolerant GPIO pins ^{1 2 3}	-0.3	—	Min of 5.25 and IOVDD +2	V
		LCD pins ³	-0.3	—	Min of 3.8 and IOVDD +2	V
		Standard GPIO pins	-0.3	—	IOVDD+0.3	V
Total current into VDD power lines	I _{VDDMAX}	Source	—	—	200	mA
Total current into VSS ground lines	I _{VSSMAX}	Sink	—	—	200	mA
Current per I/O pin	I _{IOMAX}	Sink	—	—	50	mA
		Source	—	—	50	mA
Current for all I/O pins	I _{IOALLMAX}	Sink	—	—	200	mA
		Source	—	—	200	mA
Junction temperature	T _J	-G grade devices	-40	—	105	°C
		-I grade devices	-40	—	125	°C
Voltage on regulator supply pins VREGI and VBUS	V _{VREGI}		-0.3	—	5.5	V

Note:

- When a GPIO pin is routed to the analog block through the APORT, the maximum voltage = IOVDD.
- Valid for IOVDD in valid operating range or when IOVDD is undriven (high-Z). If IOVDD is connected to a low-impedance source below the valid operating range (e.g. IOVDD shorted to VSS), the pin voltage maximum is IOVDD + 0.3 V, to avoid exceeding the maximum IO current specifications.
- To operate above the IOVDD supply rail, over-voltage tolerance must be enabled according to the GPIO_Px_OVTDIS register. Pins with over-voltage tolerance disabled have the same limits as Standard GPIO.

4.1.2 Operating Conditions

When assigning supply sources, the following requirements must be observed:

- VREGVDD must be greater than or equal to AVDD, DVDD and all IOVDD supplies.
- VREGVDD = AVDD
- DVDD \leq AVDD
- IOVDD \leq AVDD

4.1.2.1 General Operating Conditions

Table 4.2. General Operating Conditions

Parameter	Symbol	Test Condition	Min	Typ	Max	Unit
Operating ambient temperature range ¹	T _A	-G temperature grade	-40	25	85	°C
		-I temperature grade	-40	25	125	°C
AVDD supply voltage ²	V _{AVDD}		1.8	3.3	3.8	V
VREGVDD operating supply voltage ^{2 3}	V _{VREGVDD}	DCDC in regulation	2.4	3.3	3.8	V
		DCDC in bypass, 50mA load	1.8	3.3	3.8	V
		DCDC not in use. DVDD externally shorted to VREGVDD	1.8	3.3	3.8	V
VREGVDD current	I _{VREGVDD}	DCDC in bypass, T ≤ 85 °C	—	—	200	mA
		DCDC in bypass, T > 85 °C	—	—	100	mA
DVDD operating supply voltage	V _{DVDD}		1.62	—	V _{VREGVDD}	V
IOVDD operating supply voltage	V _{IOVDD}	All IOVDD pins ⁴	1.62	—	V _{VREGVDD}	V
DECOUPLE output capacitor ^{5 6}	C _{DECOUPLE}		0.75	1.0	2.75	μF
HFCORECLK frequency	f _{CORE}	VSCALE2, MODE = WS3	—	—	72	MHz
		VSCALE2, MODE = WS2	—	—	54	MHz
		VSCALE2, MODE = WS1	—	—	36	MHz
		VSCALE2, MODE = WS0	—	—	18	MHz
		VSCALE0, MODE = WS2	—	—	20	MHz
		VSCALE0, MODE = WS1	—	—	14	MHz
		VSCALE0, MODE = WS0	—	—	7	MHz
HFCLK frequency	f _{HFCLK}	VSCALE2	—	—	72	MHz
		VSCALE0	—	—	20	MHz
HFSRCCLK frequency	f _{HFSRCCLK}	VSCALE2	—	—	72	MHz
		VSCALE0	—	—	20	MHz
HFBUSCLK frequency	f _{HFBUSCLK}	VSCALE2	—	—	50	MHz
		VSCALE0	—	—	20	MHz
HFPERCLK frequency	f _{HFPERCLK}	VSCALE2	—	—	50	MHz
		VSCALE0	—	—	20	MHz
HFPERBCLK frequency	f _{HFPERBCLK}	VSCALE2	—	—	72	MHz
		VSCALE0	—	—	20	MHz
HFPERCCLK frequency	f _{HFPERCCLK}	VSCALE2	—	—	50	MHz
		VSCALE0	—	—	20	MHz

Parameter	Symbol	Test Condition	Min	Typ	Max	Unit
Note:						
1. The maximum limit on T_A may be lower due to device self-heating, which depends on the power dissipation of the specific application. T_A (max) = T_J (max) - ($\theta_{JA} \times \text{PowerDissipation}$). Refer to the Absolute Maximum Ratings table and the Thermal Characteristics table for T_J and θ_{JA} .						
2. VREGVDD must be tied to AVDD. Both VREGVDD and AVDD minimum voltages must be satisfied for the part to operate.						
3. The minimum voltage required in bypass mode is calculated using R_{BYP} from the DCDC specification table. Requirements for other loads can be calculated as $V_{DVDD_min} + I_{LOAD} * R_{BYP_max}$.						
4. When the CSEN peripheral is used with chopping enabled (CSEN_CTRL_CHOPEN = ENABLE), IOVDD must be equal to AVDD.						
5. The system designer should consult the characteristic specs of the capacitor used on DECOUPLE to ensure its capacitance value stays within the specified bounds across temperature and DC bias.						
6. VSCALE0 to VSCALE2 voltage change transitions occur at a rate of 10 mV / usec for approximately 20 usec. During this transition, peak currents will be dependent on the value of the DECOUPLE output capacitor, from 35 mA (with a 1 μ F capacitor) to 70 mA (with a 2.7 μ F capacitor).						

4.1.3 Thermal Characteristics

Table 4.3. Thermal Characteristics

Parameter	Symbol	Test Condition	Min	Typ	Max	Unit
Thermal resistance, QFN64 Package	θ_{JA_QFN64}	4-Layer PCB, Air velocity = 0 m/s	—	17.8	—	$^{\circ}\text{C}/\text{W}$
		4-Layer PCB, Air velocity = 1 m/s	—	15.4	—	$^{\circ}\text{C}/\text{W}$
		4-Layer PCB, Air velocity = 2 m/s	—	13.8	—	$^{\circ}\text{C}/\text{W}$
Thermal resistance, TQFP64 Package	θ_{JA_TQFP64}	4-Layer PCB, Air velocity = 0 m/s	—	33.9	—	$^{\circ}\text{C}/\text{W}$
		4-Layer PCB, Air velocity = 1 m/s	—	32.1	—	$^{\circ}\text{C}/\text{W}$
		4-Layer PCB, Air velocity = 2 m/s	—	30.1	—	$^{\circ}\text{C}/\text{W}$
Thermal resistance, TQFP100 Package	$\theta_{JA_TQFP100}$	4-Layer PCB, Air velocity = 0 m/s	—	44.1	—	$^{\circ}\text{C}/\text{W}$
		4-Layer PCB, Air velocity = 1 m/s	—	37.7	—	$^{\circ}\text{C}/\text{W}$
		4-Layer PCB, Air velocity = 2 m/s	—	35.5	—	$^{\circ}\text{C}/\text{W}$
Thermal resistance, BGA112 Package	θ_{JA_BGA112}	4-Layer PCB, Air velocity = 0 m/s	—	42.0	—	$^{\circ}\text{C}/\text{W}$
		4-Layer PCB, Air velocity = 1 m/s	—	37.0	—	$^{\circ}\text{C}/\text{W}$
		4-Layer PCB, Air velocity = 2 m/s	—	35.3	—	$^{\circ}\text{C}/\text{W}$
Thermal resistance, BGA120 Package	θ_{JA_BGA120}	4-Layer PCB, Air velocity = 0 m/s	—	47.9	—	$^{\circ}\text{C}/\text{W}$
		4-Layer PCB, Air velocity = 1 m/s	—	41.8	—	$^{\circ}\text{C}/\text{W}$
		4-Layer PCB, Air velocity = 2 m/s	—	39.6	—	$^{\circ}\text{C}/\text{W}$

4.1.4 DC-DC Converter

Test conditions: L_DCDC=4.7 μ H (Murata LQH3NPN4R7MM0L), C_DCDC=4.7 μ F (Samsung CL10B475KQ8NQNC), V_DCDC_I=3.3 V, V_DCDC_O=1.8 V, I_DCDC_LOAD=50 mA, Heavy Drive configuration, F_DCDC_LN=7 MHz, unless otherwise indicated.

Table 4.4. DC-DC Converter

Parameter	Symbol	Test Condition	Min	Typ	Max	Unit
Input voltage range	V _{DCDC_I}	Bypass mode, I _{DCDC_LOAD} = 50 mA	1.8	—	V _{VREGVDD_MAX}	V
		Low noise (LN) mode, 1.8 V output, I _{DCDC_LOAD} = 100 mA, or Low power (LP) mode, 1.8 V output, I _{DCDC_LOAD} = 10 mA	2.4	—	V _{VREGVDD_MAX}	V
		Low noise (LN) mode, 1.8 V output, I _{DCDC_LOAD} = 200 mA	2.6	—	V _{VREGVDD_MAX}	V
Output voltage programmable range ¹	V _{DCDC_O}		1.8	—	V _{VREGVDD}	V
Regulation DC accuracy	ACC _{DC}	Low Noise (LN) mode, 1.8 V target output	1.7	—	1.9	V
Regulation window ²	WIN _{REG}	Low Power (LP) mode, LPCMPBIASEM _{xx} ³ = 0, 1.8 V target output, I _{DCDC_LOAD} \leq 75 μ A	1.63	—	2.2	V
		Low Power (LP) mode, LPCMPBIASEM _{xx} ³ = 3, 1.8 V target output, I _{DCDC_LOAD} \leq 10 mA	1.63	—	2.1	V
Steady-state output ripple	V _R		—	3	—	mV _{pp}
Output voltage under/overshoot	V _{OV}	CCM Mode (LNFORCECCM ³ = 1), Load changes between 0 mA and 100 mA	—	25	60	mV
		DCM Mode (LNFORCECCM ³ = 0), Load changes between 0 mA and 10 mA	—	45	90	mV
		Overshoot during LP to LN CCM/DCM mode transitions compared to DC level in LN mode	—	200	—	mV
		Undershoot during BYP/LP to LN CCM (LNFORCECCM ³ = 1) mode transitions compared to DC level in LN mode	—	40	—	mV
		Undershoot during BYP/LP to LN DCM (LNFORCECCM ³ = 0) mode transitions compared to DC level in LN mode	—	100	—	mV
DC line regulation	V _{REG}	Input changes between V _{VREGVDD_MAX} and 2.4 V	—	0.1	—	%
DC load regulation	I _{REG}	Load changes between 0 mA and 100 mA in CCM mode	—	0.1	—	%

Parameter	Symbol	Test Condition	Min	Typ	Max	Unit
Max load current	I _{LOAD_MAX}	Low noise (LN) mode, Heavy Drive ⁴ , T ≤ 85 °C	—	—	200	mA
		Low noise (LN) mode, Heavy Drive ⁴ , T > 85 °C	—	—	100	mA
		Low noise (LN) mode, Medium Drive ⁴	—	—	100	mA
		Low noise (LN) mode, Light Drive ⁴	—	—	50	mA
		Low power (LP) mode, LPCMPBIASEMxx ³ = 0	—	—	75	μA
		Low power (LP) mode, LPCMPBIASEMxx ³ = 3	—	—	10	mA
DCDC nominal output capacitor ⁵	C _{DCDC}	25% tolerance	1	4.7	4.7	μF
DCDC nominal output inductor	L _{DCDC}	20% tolerance	4.7	4.7	4.7	μH
Resistance in Bypass mode	R _{BYP}		—	1.2	2.5	Ω

Note:

1. Due to internal dropout, the DC-DC output will never be able to reach its input voltage, V_{VREGVDD}.
2. LP mode controller is a hysteretic controller that maintains the output voltage within the specified limits.
3. LPCMPBIASEMxx refers to either LPCMPBIASEM234H in the EMU_DCDCMISCCTRL register or LPCMPBIASEM01 in the EMU_DCDCLOEM01CFG register, depending on the energy mode.
4. Drive levels are defined by configuration of the PFETCNT and NFETCNT registers. Light Drive: PFETCNT=NFETCNT=3; Medium Drive: PFETCNT=NFETCNT=7; Heavy Drive: PFETCNT=NFETCNT=15.
5. Output voltage under/over-shoot and regulation are specified with C_{DCDC} 4.7 μF. Different settings for DCDCLNCOMPCTRL must be used if C_{DCDC} is lower than 4.7 μF. See Application Note AN0948 for details.

4.1.5 5V Regulator

$V_{VREGI} = 5\text{ V}$, $V_{VREGO} = 3.3\text{ V}$, $C_{VREGI} = 10\text{ }\mu\text{F}$, $C_{VREGO} = 4.7\text{ }\mu\text{F}$, unless otherwise specified.

Table 4.5. 5V Regulator

Parameter	Symbol	Test Condition	Min	Typ	Max	Unit
VREGI or VBUS input voltage range	V_{VREGI}	Regulating output	2.7	—	5.5	V
		Bypass mode enabled	2.7	—	3.8	V
VREGO output voltage	V_{VREGO}	Regulating output, 3.3 V setting ¹	3.1	3.3	3.5	V
		EM4S open-loop output, $I_{OUT} < 100\text{ }\mu\text{A}$	1.8	—	3.8	V
Voltage output step size	V_{VREGO_SS}		—	0.1	—	V
Resistance in Bypass Mode	R_{BYP}	Bypass mode enabled	—	1.2	2.5	Ω
Output current	I_{OUT}	EM0 or EM1, $V_{VREGI} > V_{VREGO} + 0.6\text{ V}$	—	—	200	mA
		EM0 or EM1, $V_{VREGI} > V_{VREGO} + 0.3\text{ V}$	—	—	100	mA
		EM2, EM3, or EM4H, $V_{VREGI} > V_{VREGO} + 0.6\text{ V}$	—	—	2	mA
		EM2, EM3, or EM4H, $V_{VREGI} > V_{VREGO} + 0.3\text{ V}$	—	—	0.5	mA
		EM4S	—	—	20	μA
Load regulation	LR_{VREGO}	EM0 or EM1	—	0.10	—	mV/mA
		EM2, EM3, or EM4H	—	2.5	—	mV/mA
DC power supply rejection	PSR_{DC}		—	40	—	dB
VREGI or VBUS bypass capacitance	C_{VREGI}		—	10	—	μF
VREGO bypass capacitance	C_{VREGO}		1	4.7	10	μF
Supply current consumption	I_{VREGI}	EM0 or EM1, No load	—	29	—	μA
		EM2, EM3, or EM4H, No load	—	270	—	nA
		EM4S, No load	—	70	—	nA
VREGI and VBUS detection high threshold	V_{DET_H}		0.9	1.15	—	V
VREGI and VBUS detection low threshold	V_{DET_L}		—	1.07	1.45	V
Current monitor transfer ratio	$IMON_{XF}$	Translation of current through VREGO path to voltage at ADC input	—	0.35	—	mA/mV

Note:

- Output may be disturbed during DCDC mode transitions from BYPASS or OFF mode to LOWNOISE mode. Perturbation on VREGO can temporarily bring VREGO up beyond 3.5 V during these DCDC mode transitions. Refer to the EFM32GG12 Errata document, item EMU_E219 for more details.

4.1.6 Backup Supply Domain

Table 4.6. Backup Supply Domain

Parameter	Symbol	Test Condition	Min	Typ	Max	Unit
Backup supply voltage range	V _{BU_VIN}		1.8	—	3.8	V
PWRRES resistor	R _{PWRRES}	EMU_BUCTRL_PWRRES = RES0	3400	3900	4400	Ω
		EMU_BUCTRL_PWRRES = RES1	1450	1800	2150	Ω
		EMU_BUCTRL_PWRRES = RES2	1000	1350	1700	Ω
		EMU_BUCTRL_PWRRES = RES3	525	815	1100	Ω
Output impedance between BU_VIN and BU_VOUT ¹	R _{BU_VOUT}	EMU_BUCTRL_VOUTRES = STRONG	35	110	185	Ω
		EMU_BUCTRL_VOUTRES = MED	475	775	1075	Ω
		EMU_BUCTRL_VOUTRES = WEAK	5600	6500	7400	Ω
Supply current	I _{BU_VIN}	BU_VIN not powering backup domain, 25 °C	—	11	70	nA
		BU_VIN powering backup domain, 25 °C ²	—	550	2500	nA

Note:

1. BU_VOUT and BU_STAT signals are not available in all package configurations. Check the device pinout for availability.
2. Additional current required by backup circuitry when backup is active. Includes supply current of backup switches and backup regulator. Does not include supply current required for backed-up circuitry.

4.1.7 Current Consumption

4.1.7.1 Current Consumption 3.3 V without DC-DC Converter

Unless otherwise indicated, typical conditions are: VREGVDD = AVDD = DVDD = 3.3 V. T = 25 °C. DCDC is off. Minimum and maximum values in this table represent the worst conditions across process variation at T = 25 °C.

Table 4.7. Current Consumption 3.3 V without DC-DC Converter

Parameter	Symbol	Test Condition	Min	Typ	Max	Unit
Current consumption in EM0 mode with all peripherals disabled	I _{ACTIVE}	72 MHz HFRCO, CPU running Prime from flash	—	113	—	μA/MHz
		72 MHz HFRCO, CPU running while loop from flash	—	112	125	μA/MHz
		72 MHz HFRCO, CPU running CoreMark loop from flash	—	128	—	μA/MHz
		50 MHz crystal, CPU running while loop from flash	—	110	—	μA/MHz
		48 MHz HFRCO, CPU running while loop from flash	—	113	130	μA/MHz
		32 MHz HFRCO, CPU running while loop from flash	—	115	—	μA/MHz
		26 MHz HFRCO, CPU running while loop from flash	—	116	135	μA/MHz
		16 MHz HFRCO, CPU running while loop from flash	—	122	—	μA/MHz
		1 MHz HFRCO, CPU running while loop from flash	—	308	400	μA/MHz
Current consumption in EM0 mode with all peripherals disabled and voltage scaling enabled	I _{ACTIVE_VS}	19 MHz HFRCO, CPU running while loop from flash	—	99	—	μA/MHz
		1 MHz HFRCO, CPU running while loop from flash	—	255	—	μA/MHz
Current consumption in EM1 mode with all peripherals disabled	I _{EM1}	72 MHz HFRCO	—	51	57	μA/MHz
		50 MHz crystal	—	49	—	μA/MHz
		48 MHz HFRCO	—	51	60	μA/MHz
		32 MHz HFRCO	—	54	—	μA/MHz
		26 MHz HFRCO	—	55	64	μA/MHz
		16 MHz HFRCO	—	60	—	μA/MHz
		1 MHz HFRCO	—	246	350	μA/MHz
Current consumption in EM1 mode with all peripherals disabled and voltage scaling enabled	I _{EM1_VS}	19 MHz HFRCO	—	49	—	μA/MHz
		1 MHz HFRCO	—	204	—	μA/MHz

Parameter	Symbol	Test Condition	Min	Typ	Max	Unit
Current consumption in EM2 mode, with voltage scaling enabled	I _{EM2_VS}	Full 192 kB RAM retention and RTCC running from LFXO	—	3.0	—	μA
		Full 192 kB RAM retention and RTCC running from LFRCO	—	3.4	—	μA
		16 kB (1 bank) RAM retention and RTCC running from LFRCO ¹	—	2.4	4.7	μA
Current consumption in EM3 mode, with voltage scaling enabled	I _{EM3_VS}	Full 192 kB RAM retention and CRYOTIMER running from ULFRCO	—	2.7	7	μA
Current consumption in EM4H mode, with voltage scaling enabled	I _{EM4H_VS}	128 byte RAM retention, RTCC running from LFXO	—	0.94	—	μA
		128 byte RAM retention, CRYOTIMER running from ULFRCO	—	0.59	—	μA
		128 byte RAM retention, no RTCC	—	0.59	1.15	μA
Current consumption in EM4S mode	I _{EM4S}	No RAM retention, no RTCC	—	0.08	0.16	μA
Current consumption of peripheral power domain 1, with voltage scaling enabled	I _{PD1_VS}	Additional current consumption in EM2/3 when any peripherals on power domain 1 are enabled ²	—	0.73	—	μA
Current consumption of peripheral power domain 2, with voltage scaling enabled	I _{PD2_VS}	Additional current consumption in EM2/3 when any peripherals on power domain 2 are enabled ²	—	0.32	—	μA

Note:

1. CMU_LFRCCOCTRL_ENVREF = 1, CMU_LFRCCOCTRL_VREFUPDATE = 1
2. Extra current consumed by power domain. Does not include current associated with the enabled peripherals. See [3.2.4 EM2 and EM3 Power Domains](#) for a list of the peripherals in each power domain.

4.1.7.2 Current Consumption 3.3 V using DC-DC Converter

Unless otherwise indicated, typical conditions are: VREGVDD = AVDD = IOVDD = 3.3 V, DVDD = 1.8 V DC-DC output. T = 25 °C. Minimum and maximum values in this table represent the worst conditions across process variation at T = 25 °C.

Table 4.8. Current Consumption 3.3 V using DC-DC Converter

Parameter	Symbol	Test Condition	Min	Typ	Max	Unit
Current consumption in EM0 mode with all peripherals disabled, DCDC in Low Noise DCM mode ¹	I _{ACTIVE_DCM}	72 MHz HFRCO, CPU running Prime from flash	—	76	—	μA/MHz
		72 MHz HFRCO, CPU running while loop from flash	—	75	—	μA/MHz
		72 MHz HFRCO, CPU running CoreMark loop from flash	—	85	—	μA/MHz
		50 MHz crystal, CPU running while loop from flash	—	76	—	μA/MHz
		48 MHz HFRCO, CPU running while loop from flash	—	78	—	μA/MHz
		32 MHz HFRCO, CPU running while loop from flash	—	85	—	μA/MHz
		26 MHz HFRCO, CPU running while loop from flash	—	89	—	μA/MHz
		16 MHz HFRCO, CPU running while loop from flash	—	104	—	μA/MHz
		1 MHz HFRCO, CPU running while loop from flash	—	686	—	μA/MHz
Current consumption in EM0 mode with all peripherals disabled, DCDC in Low Noise CCM mode ²	I _{ACTIVE_CCM}	72 MHz HFRCO, CPU running Prime from flash	—	80	—	μA/MHz
		72 MHz HFRCO, CPU running while loop from flash	—	79	—	μA/MHz
		72 MHz HFRCO, CPU running CoreMark loop from flash	—	89	—	μA/MHz
		50 MHz crystal, CPU running while loop from flash	—	84	—	μA/MHz
		48 MHz HFRCO, CPU running while loop from flash	—	87	—	μA/MHz
		32 MHz HFRCO, CPU running while loop from flash	—	100	—	μA/MHz
		26 MHz HFRCO, CPU running while loop from flash	—	109	—	μA/MHz
		16 MHz HFRCO, CPU running while loop from flash	—	139	—	μA/MHz
		1 MHz HFRCO, CPU running while loop from flash	—	1290	—	μA/MHz

Parameter	Symbol	Test Condition	Min	Typ	Max	Unit
Current consumption in EM0 mode with all peripherals disabled, DCDC in LP mode ³	I _{ACTIVE_LPM}	32 MHz HFRCO, CPU running while loop from flash	—	76	—	μA/MHz
		26 MHz HFRCO, CPU running while loop from flash	—	77	—	μA/MHz
		16 MHz HFRCO, CPU running while loop from flash	—	82	—	μA/MHz
		1 MHz HFRCO, CPU running while loop from flash	—	257	—	μA/MHz
Current consumption in EM0 mode with all peripherals disabled and voltage scaling enabled, DCDC in Low Noise CCM mode ²	I _{ACTIVE_CCM_VS}	19 MHz HFRCO, CPU running while loop from flash	—	115	—	μA/MHz
		1 MHz HFRCO, CPU running while loop from flash	—	1259	—	μA/MHz
Current consumption in EM0 mode with all peripherals disabled and voltage scaling enabled, DCDC in LP mode ³	I _{ACTIVE_LPM_VS}	19 MHz HFRCO, CPU running while loop from flash	—	67	—	μA/MHz
		1 MHz HFRCO, CPU running while loop from flash	—	214	—	μA/MHz
Current consumption in EM1 mode with all peripherals disabled, DCDC in Low Noise DCM mode ¹	I _{EM1_DCM}	72 MHz HFRCO	—	38	—	μA/MHz
		50 MHz crystal	—	39	—	μA/MHz
		48 MHz HFRCO	—	42	—	μA/MHz
		32 MHz HFRCO	—	48	—	μA/MHz
		26 MHz HFRCO	—	53	—	μA/MHz
		16 MHz HFRCO	—	68	—	μA/MHz
		1 MHz HFRCO	—	652	—	μA/MHz
Current consumption in EM1 mode with all peripherals disabled, DCDC in Low Power mode ³	I _{EM1_LPM}	32 MHz HFRCO	—	37	—	μA/MHz
		26 MHz HFRCO	—	39	—	μA/MHz
		16 MHz HFRCO	—	43	—	μA/MHz
		1 MHz HFRCO	—	209	—	μA/MHz
Current consumption in EM1 mode with all peripherals disabled and voltage scaling enabled, DCDC in Low Noise DCM mode ¹	I _{EM1_DCM_VS}	19 MHz HFRCO	—	56	—	μA/MHz
		1 MHz HFRCO	—	627	—	μA/MHz
Current consumption in EM1 mode with all peripherals disabled and voltage scaling enabled. DCDC in LP mode ³	I _{EM1_LPM_VS}	19 MHz HFRCO	—	35	—	μA/MHz
		1 MHz HFRCO	—	185	—	μA/MHz
Current consumption in EM2 mode, with voltage scaling enabled, DCDC in LP mode ³	I _{EM2_VS}	Full 192 kB RAM retention and RTCC running from LFXO	—	2.2	—	μA
		Full 192 kB RAM retention and RTCC running from LFRCO	—	2.5	—	μA
		16 kB (1 bank) RAM retention and RTCC running from LFRCO ⁴	—	1.8	—	μA
Current consumption in EM3 mode, with voltage scaling enabled	I _{EM3_VS}	Full 192 kB RAM retention and CRYOTIMER running from ULFR-CO	—	1.9	—	μA

Parameter	Symbol	Test Condition	Min	Typ	Max	Unit
Current consumption in EM4H mode, with voltage scaling enabled	I _{EM4H_VS}	128 byte RAM retention, RTCC running from LFXO	—	0.86	—	μA
		128 byte RAM retention, CRYO-TIMER running from ULFRCO	—	0.55	—	μA
		128 byte RAM retention, no RTCC	—	0.55	—	μA
Current consumption in EM4S mode	I _{EM4S}	No RAM retention, no RTCC	—	0.08	—	μA
Current consumption of peripheral power domain 1, with voltage scaling enabled, DCDC in LP mode ³	I _{PD1_VS}	Additional current consumption in EM2/3 when any peripherals on power domain 1 are enabled ⁵	—	0.76	—	μA
Current consumption of peripheral power domain 2, with voltage scaling enabled, DCDC in LP mode ³	I _{PD2_VS}	Additional current consumption in EM2/3 when any peripherals on power domain 2 are enabled ⁵	—	0.32	—	μA

Note:

1. DCDC Low Noise DCM Mode = Light Drive (PFETCNT=NFETCNT=3), F=3.0 MHz (RCOBAND=0), ANASW=DVDD.
2. DCDC Low Noise CCM Mode = Light Drive (PFETCNT=NFETCNT=3), F=6.4 MHz (RCOBAND=4), ANASW=DVDD.
3. DCDC Low Power Mode = Medium Drive, LPOSCDIV=1, LPCMPBIASEM234H=0, LPCLIMLIMSEL=1, ANASW=DVDD.
4. CMU_LFRCOCTRL_ENVREF = 1, CMU_LFRCOCTRL_VREFUPDATE = 1
5. Extra current consumed by power domain. Does not include current associated with the enabled peripherals. See [3.2.4 EM2 and EM3 Power Domains](#) for a list of the peripherals in each power domain.

4.1.7.3 Current Consumption 1.8 V without DC-DC Converter

Unless otherwise indicated, typical conditions are: VREGVDD = AVDD = DVDD = 1.8 V. T = 25 °C. DCDC is off. Minimum and maximum values in this table represent the worst conditions across process variation at T = 25 °C.

Table 4.9. Current Consumption 1.8 V without DC-DC Converter

Parameter	Symbol	Test Condition	Min	Typ	Max	Unit
Current consumption in EM0 mode with all peripherals disabled	I _{ACTIVE}	72 MHz HFRCO, CPU running Prime from flash	—	113	—	μA/MHz
		72 MHz HFRCO, CPU running while loop from flash	—	112	—	μA/MHz
		72 MHz HFRCO, CPU running CoreMark loop from flash	—	128	—	μA/MHz
		50 MHz crystal, CPU running while loop from flash	—	110	—	μA/MHz
		48 MHz HFRCO, CPU running while loop from flash	—	112	—	μA/MHz
		32 MHz HFRCO, CPU running while loop from flash	—	115	—	μA/MHz
		26 MHz HFRCO, CPU running while loop from flash	—	116	—	μA/MHz
		16 MHz HFRCO, CPU running while loop from flash	—	122	—	μA/MHz
		1 MHz HFRCO, CPU running while loop from flash	—	304	—	μA/MHz
Current consumption in EM0 mode with all peripherals disabled and voltage scaling enabled	I _{ACTIVE_VS}	19 MHz HFRCO, CPU running while loop from flash	—	99	—	μA/MHz
		1 MHz HFRCO, CPU running while loop from flash	—	251	—	μA/MHz
Current consumption in EM1 mode with all peripherals disabled	I _{EM1}	72 MHz HFRCO	—	51	—	μA/MHz
		50 MHz crystal	—	49	—	μA/MHz
		48 MHz HFRCO	—	51	—	μA/MHz
		32 MHz HFRCO	—	53	—	μA/MHz
		26 MHz HFRCO	—	55	—	μA/MHz
		16 MHz HFRCO	—	60	—	μA/MHz
		1 MHz HFRCO	—	242	—	μA/MHz
Current consumption in EM1 mode with all peripherals disabled and voltage scaling enabled	I _{EM1_VS}	19 MHz HFRCO	—	49	—	μA/MHz
		1 MHz HFRCO	—	201	—	μA/MHz
Current consumption in EM2 mode, with voltage scaling enabled	I _{EM2_VS}	Full 192 kB RAM retention and RTCC running from LFXO	—	2.9	—	μA
		Full 192 kB RAM retention and RTCC running from LFRCO	—	3.1	—	μA
		16 kB (1 bank) RAM retention and RTCC running from LFRCO ¹	—	2.1	—	μA

Parameter	Symbol	Test Condition	Min	Typ	Max	Unit
Current consumption in EM3 mode, with voltage scaling enabled	I_{EM3_VS}	Full 192 kB RAM retention and CRYOTIMER running from ULFR-CO	—	2.6	—	μA
Current consumption in EM4H mode, with voltage scaling enabled	I_{EM4H_VS}	128 byte RAM retention, RTCC running from LFXO	—	0.85	—	μA
		128 byte RAM retention, CRYO-TIMER running from ULFR-CO	—	0.48	—	μA
		128 byte RAM retention, no RTCC	—	0.48	—	μA
Current consumption in EM4S mode	I_{EM4S}	No RAM retention, no RTCC	—	0.06	—	μA
Current consumption of peripheral power domain 1, with voltage scaling enabled	I_{PD1_VS}	Additional current consumption in EM2/3 when any peripherals on power domain 1 are enabled ²	—	0.75	—	μA
Current consumption of peripheral power domain 2, with voltage scaling enabled	I_{PD2_VS}	Additional current consumption in EM2/3 when any peripherals on power domain 2 are enabled ²	—	0.32	—	μA

Note:

1. $CMU_LFRCCOCTRL_ENVREF = 1$, $CMU_LFRCCOCTRL_VREFUPDATE = 1$
2. Extra current consumed by power domain. Does not include current associated with the enabled peripherals. See [3.2.4 EM2 and EM3 Power Domains](#) for a list of the peripherals in each power domain.

4.1.8 Wake Up Times

Table 4.10. Wake Up Times

Parameter	Symbol	Test Condition	Min	Typ	Max	Unit
Wake up time from EM1	t_{EM1_WU}		—	3	—	AHB Clocks
Wake up from EM2	t_{EM2_WU}	Code execution from flash	—	11.4	—	μs
		Code execution from RAM	—	3.8	—	μs
Wake up from EM3	t_{EM3_WU}	Code execution from flash	—	11.4	—	μs
		Code execution from RAM	—	3.8	—	μs
Wake up from EM4H ¹	t_{EM4H_WU}	Executing from flash	—	92	—	μs
Wake up from EM4S ¹	t_{EM4S_WU}	Executing from flash	—	288	—	μs
Time from release of reset source to first instruction execution	t_{RESET}	Soft Pin Reset released	—	53	—	μs
		Any other reset released	—	347	—	μs
Power mode scaling time	t_{SCALE}	VSCALE0 to VSCALE2, HFCLK = 19 MHz ^{2 3}	—	31.8	—	μs
		VSCALE2 to VSCALE0, HFCLK = 19 MHz ⁴	—	4.3	—	μs

Note:

1. Time from wake up request until first instruction is executed. Wakeup results in device reset.
2. Scaling up from VSCALE0 to VSCALE2 requires approximately $30.3 \mu\text{s} + 28 \text{ HFCLKs}$.
3. VSCALE0 to VSCALE2 voltage change transitions occur at a rate of $10 \text{ mV}/\mu\text{s}$ for approximately $20 \mu\text{s}$. During this transition, peak currents will be dependent on the value of the DECOUPLE output capacitor, from 35 mA (with a $1 \mu\text{F}$ capacitor) to 70 mA (with a $2.7 \mu\text{F}$ capacitor).
4. Scaling down from VSCALE2 to VSCALE0 requires approximately $2.8 \mu\text{s} + 29 \text{ HFCLKs}$.

4.1.9 Brown Out Detector (BOD)

Table 4.11. Brown Out Detector (BOD)

Parameter	Symbol	Test Condition	Min	Typ	Max	Unit
DVDD BOD threshold	V _{DVddbOD}	DVDD rising	—	—	1.62	V
		DVDD falling (EM0/EM1)	1.35	—	—	V
		DVDD falling (EM2/EM3)	1.3	—	—	V
DVDD BOD hysteresis	V _{DVddbOD_HYST}		—	18	—	mV
DVDD BOD response time	t _{DVddbOD_DELAY}	Supply drops at 0.1V/μs rate	—	2.4	—	μs
AVDD BOD threshold	V _{AVddbOD}	AVDD rising	—	—	1.8	V
		AVDD falling (EM0/EM1)	1.62	—	—	V
		AVDD falling (EM2/EM3)	1.53	—	—	V
AVDD BOD hysteresis	V _{AVddbOD_HYST}		—	20	—	mV
AVDD BOD response time	t _{AVddbOD_DELAY}	Supply drops at 0.1V/μs rate	—	2.4	—	μs
EM4 BOD threshold	V _{EM4dBOD}	AVDD rising	—	—	1.7	V
		AVDD falling	1.45	—	—	V
EM4 BOD hysteresis	V _{EM4BOD_HYST}		—	25	—	mV
EM4 BOD response time	t _{EM4BOD_DELAY}	Supply drops at 0.1V/μs rate	—	300	—	μs

4.1.10 Oscillators

4.1.10.1 Low-Frequency Crystal Oscillator (LFXO)

Table 4.12. Low-Frequency Crystal Oscillator (LFXO)

Parameter	Symbol	Test Condition	Min	Typ	Max	Unit
Crystal frequency	f_{LFXO}		—	32.768	—	kHz
Supported crystal equivalent series resistance (ESR)	ESR_{LFXO}		—	—	70	k Ω
Supported range of crystal load capacitance ¹	C_{LFXO_CL}		6	—	18	pF
On-chip tuning cap range ²	C_{LFXO_T}	On each of LFX TAL_N and LFX TAL_P pins	8	—	40	pF
On-chip tuning cap step size	SS_{LFXO}		—	0.25	—	pF
Current consumption after startup ³	I_{LFXO}	ESR = 70 k Ω , C_L = 7 pF, GAIN ⁴ = 2, AGC ⁴ = 1	—	273	—	nA
Start-up time	t_{LFXO}	ESR = 70 k Ω , C_L = 7 pF, GAIN ⁴ = 2	—	308	—	ms

Note:

1. Total load capacitance as seen by the crystal.
2. The effective load capacitance seen by the crystal will be $C_{LFXO_T} / 2$. This is because each XTAL pin has a tuning cap and the two caps will be seen in series by the crystal.
3. Block is supplied by AVDD if ANASW = 0, or DVDD if ANASW=1 in EMU_PWRCTRL register.
4. In CMU_LFXOCTRL register.

4.1.10.2 High-Frequency Crystal Oscillator (HFXO)

Table 4.13. High-Frequency Crystal Oscillator (HFXO)

Parameter	Symbol	Test Condition	Min	Typ	Max	Unit
Crystal frequency	f_{HFXO}	No clock doubling	4	—	50	MHz
		Clock doubler enabled	4	—	25	MHz
Supported crystal equivalent series resistance (ESR)	ESR_{HFXO}	50 MHz crystal	—	—	50	Ω
		24 MHz crystal	—	—	150	Ω
		4 MHz crystal	—	—	180	Ω
Nominal on-chip tuning cap range ¹	$C_{\text{HFXO_T}}$	On each of HFXTAL_N and HFXTAL_P pins	8.7	—	51.7	pF
On-chip tuning capacitance step	SS_{HFXO}		—	0.084	—	pF
Startup time	t_{HFXO}	50 MHz crystal, ESR = 50 Ohm, $C_L = 8$ pF	—	350	—	μs
		24 MHz crystal, ESR = 150 Ohm, $C_L = 6$ pF	—	700	—	μs
		4 MHz crystal, ESR = 180 Ohm, $C_L = 18$ pF	—	3	—	ms
Current consumption after startup	I_{HFXO}	50 MHz crystal	—	660	—	μA
		24 MHz crystal	—	330	—	μA
		4 MHz crystal	—	70	—	μA

Note:

1. The effective load capacitance seen by the crystal will be $C_{\text{HFXO_T}}/2$. This is because each XTAL pin has a tuning cap and the two caps will be seen in series by the crystal.

4.1.10.3 Low-Frequency RC Oscillator (LFRCO)

Table 4.14. Low-Frequency RC Oscillator (LFRCO)

Parameter	Symbol	Test Condition	Min	Typ	Max	Unit
Oscillation frequency	f_{LFRCO}	ENVREF ¹ = 1, T ≤ 85 °C	31.3	32.768	33.6	kHz
		ENVREF ¹ = 1, T > 85 °C	31	32.768	36.8	kHz
		ENVREF ¹ = 0, T ≤ 85 °C	31.3	32.768	33.4	kHz
		ENVREF ¹ = 0, T > 85 °C	30	32.768	33.6	kHz
Startup time	t_{LFRCO}		—	500	—	μs
Current consumption ²	I_{LFRCO}	ENVREF = 1 in CMU_LFRCOCTRL	—	370	—	nA
		ENVREF = 0 in CMU_LFRCOCTRL	—	520	—	nA

Note:

1. In CMU_LFRCOCTRL register.
2. Block is supplied by AVDD if ANASW = 0, or DVDD if ANASW=1 in EMU_PWRCTRL register.

4.1.10.4 High-Frequency RC Oscillator (HFRCO)

Table 4.15. High-Frequency RC Oscillator (HFRCO)

Parameter	Symbol	Test Condition	Min	Typ	Max	Unit
Frequency accuracy	$f_{\text{HFRCO_ACC}}$	At production calibrated frequencies, across supply voltage and temperature	-2.5	—	2.5	%
Start-up time	t_{HFRCO}	$f_{\text{HFRCO}} \geq 19 \text{ MHz}$	—	300	—	ns
		$4 < f_{\text{HFRCO}} < 19 \text{ MHz}$	—	1	—	μs
		$f_{\text{HFRCO}} \leq 4 \text{ MHz}$	—	2.5	—	μs
Maximum DPLL lock time ¹	$t_{\text{DPLL_LOCK}}$	$f_{\text{REF}} = 32.768 \text{ kHz}$, $f_{\text{HFRCO}} = 39.98 \text{ MHz}$, $N = 1219$, $M = 0$	—	183	—	μs
Current consumption on all supplies	I_{HFRCO}	$f_{\text{HFRCO}} = 72 \text{ MHz}$	—	550	600	μA
		$f_{\text{HFRCO}} = 64 \text{ MHz}$	—	500	550	μA
		$f_{\text{HFRCO}} = 56 \text{ MHz}$	—	430	475	μA
		$f_{\text{HFRCO}} = 48 \text{ MHz}$	—	380	410	μA
		$f_{\text{HFRCO}} = 38 \text{ MHz}$	—	310	340	μA
		$f_{\text{HFRCO}} = 32 \text{ MHz}$	—	265	280	μA
		$f_{\text{HFRCO}} = 26 \text{ MHz}$	—	220	235	μA
		$f_{\text{HFRCO}} = 19 \text{ MHz}$	—	180	190	μA
		$f_{\text{HFRCO}} = 16 \text{ MHz}$	—	150	160	μA
		$f_{\text{HFRCO}} = 13 \text{ MHz}$	—	135	140	μA
		$f_{\text{HFRCO}} = 7 \text{ MHz}$	—	98	102	μA
		$f_{\text{HFRCO}} = 4 \text{ MHz}$	—	38	42	μA
		$f_{\text{HFRCO}} = 2 \text{ MHz}$	—	32	35	μA
		$f_{\text{HFRCO}} = 1 \text{ MHz}$	—	28	30	μA
		$f_{\text{HFRCO}} = 72 \text{ MHz}$, DPLL enabled	—	580	650	μA
		$f_{\text{HFRCO}} = 40 \text{ MHz}$, DPLL enabled	—	500	525	μA
		$f_{\text{HFRCO}} = 32 \text{ MHz}$, DPLL enabled	—	400	420	μA
		$f_{\text{HFRCO}} = 16 \text{ MHz}$, DPLL enabled	—	220	235	μA
		$f_{\text{HFRCO}} = 4 \text{ MHz}$, DPLL enabled	—	56	60	μA
$f_{\text{HFRCO}} = 1 \text{ MHz}$, DPLL enabled	—	35	38	μA		
Coarse trim step size (% of period)	$SS_{\text{HFRCO_COARSE}}$		—	0.8	—	%
Fine trim step size (% of period)	$SS_{\text{HFRCO_FINE}}$		—	0.1	—	%
Period jitter	PJ_{HFRCO}		—	0.2	—	% RMS

Parameter	Symbol	Test Condition	Min	Typ	Max	Unit
Frequency limits	f _{HFRCO_BAND}	FREQRANGE = 0, FINETUNINGEN = 0	1	—	10	MHz
		FREQRANGE = 3, FINETUNINGEN = 0	2	—	17	MHz
		FREQRANGE = 6, FINETUNINGEN = 0	4	—	30	MHz
		FREQRANGE = 7, FINETUNINGEN = 0	5	—	34	MHz
		FREQRANGE = 8, FINETUNINGEN = 0	7	—	42	MHz
		FREQRANGE = 10, FINETUNINGEN = 0	12	—	58	MHz
		FREQRANGE = 11, FINETUNINGEN = 0	15	—	68	MHz
		FREQRANGE = 12, FINETUNINGEN = 0	18	—	83	MHz
		FREQRANGE = 13, FINETUNINGEN = 0	24	—	100	MHz
		FREQRANGE = 14, FINETUNINGEN = 0	28	—	119	MHz
		FREQRANGE = 15, FINETUNINGEN = 0	33	—	138	MHz
		FREQRANGE = 16, FINETUNINGEN = 0	43	—	163	MHz

Note:

1. Maximum DPLL lock time $\sim 6 \times (M+1) \times t_{REF}$, where t_{REF} is the reference clock period.

4.1.10.5 Auxiliary High-Frequency RC Oscillator (AUXHFRCO)

Table 4.16. Auxiliary High-Frequency RC Oscillator (AUXHFRCO)

Parameter	Symbol	Test Condition	Min	Typ	Max	Unit
Frequency accuracy	$f_{\text{AUXHFRCO_ACC}}$	At production calibrated frequencies, across supply voltage and temperature	-3	—	3	%
Start-up time	t_{AUXHFRCO}	$f_{\text{AUXHFRCO}} \geq 19 \text{ MHz}$	—	400	—	ns
		$4 < f_{\text{AUXHFRCO}} < 19 \text{ MHz}$	—	1.4	—	μs
		$f_{\text{AUXHFRCO}} \leq 4 \text{ MHz}$	—	2.5	—	μs
Current consumption on all supplies	I_{AUXHFRCO}	$f_{\text{AUXHFRCO}} = 50 \text{ MHz}$	—	270	285	μA
		$f_{\text{AUXHFRCO}} = 48 \text{ MHz}$	—	255	272	μA
		$f_{\text{AUXHFRCO}} = 38 \text{ MHz}$	—	212	225	μA
		$f_{\text{AUXHFRCO}} = 32 \text{ MHz}$	—	174	185	μA
		$f_{\text{AUXHFRCO}} = 26 \text{ MHz}$	—	148	158	μA
		$f_{\text{AUXHFRCO}} = 19 \text{ MHz}$	—	118	127	μA
		$f_{\text{AUXHFRCO}} = 16 \text{ MHz}$	—	108	116	μA
		$f_{\text{AUXHFRCO}} = 13 \text{ MHz}$	—	88	112	μA
		$f_{\text{AUXHFRCO}} = 7 \text{ MHz}$	—	59	72	μA
		$f_{\text{AUXHFRCO}} = 4 \text{ MHz}$	—	32	36	μA
		$f_{\text{AUXHFRCO}} = 2 \text{ MHz}$	—	27	30	μA
$f_{\text{AUXHFRCO}} = 1 \text{ MHz}$	—	26	28	μA		
Coarse trim step size (% of period)	$SS_{\text{AUXHFRCO_COARSE}}$		—	0.8	—	%
Fine trim step size (% of period)	$SS_{\text{AUXHFRCO_FINE}}$		—	0.1	—	%
Period jitter	PJ_{AUXHFRCO}		—	0.2	—	% RMS

4.1.10.6 USB High-Frequency RC Oscillator (USHFRCO)

Table 4.17. USB High-Frequency RC Oscillator (USHFRCO)

Parameter	Symbol	Test Condition	Min	Typ	Max	Unit
Frequency accuracy	$f_{USHFRCO_ACC}$	At production calibrated frequencies, across supply voltage and temperature	-2.5	—	2.5	%
		USB clock recovery enabled, Active connection as device, FINE-TUNINGEN ¹ = 1	-0.25	—	0.25	%
Start-up time	$t_{USHFRCO}$		—	300	—	ns
Current consumption on all supplies	$I_{USHFRCO}$	$f_{USHFRCO} = 48$ MHz, FINETUNINGEN ¹ = 1	—	293	305	μ A
		$f_{USHFRCO} = 50$ MHz, FINETUNINGEN ¹ = 0	—	257	270	μ A
		$f_{USHFRCO} = 48$ MHz, FINETUNINGEN ¹ = 0	—	249	260	μ A
		$f_{USHFRCO} = 32$ MHz, FINETUNINGEN ¹ = 0	—	165	176	μ A
		$f_{USHFRCO} = 16$ MHz, FINETUNINGEN ¹ = 0	—	100	111	μ A
Period jitter	$PJ_{USHFRCO}$		—	0.2	—	% RMS
Note: 1. In the CMU_USHFRCOCTRL register.						

4.1.10.7 Ultra-low Frequency RC Oscillator (ULFRCO)

Table 4.18. Ultra-low Frequency RC Oscillator (ULFRCO)

Parameter	Symbol	Test Condition	Min	Typ	Max	Unit
Oscillation frequency	f_{ULFRCO}		0.88	1	1.12	kHz

4.1.11 Flash Memory Characteristics¹

Table 4.19. Flash Memory Characteristics¹

Parameter	Symbol	Test Condition	Min	Typ	Max	Unit
Flash erase cycles before failure	EC _{FLASH}		10000	—	—	cycles
Flash data retention	RET _{FLASH}	T ≤ 85 °C	10	—	—	years
		T ≤ 125 °C	10	—	—	years
Word (32-bit) programming time	t _{W_PROG}	Burst write, 128 words, average time per word	20	27	32	µs
		Single word	59	68	80	µs
Page erase time ²	t _{PERASE}		20	27	35	ms
Mass erase time ³	t _{MERASE}		20	27	35	ms
Device erase time ^{4 5}	t _{DERASE}	T ≤ 85 °C	—	80	95	ms
		T ≤ 125 °C	—	80	100	ms
Erase current ⁶	I _{ERASE}	Page Erase	—	—	1.6	mA
		Mass or Device Erase	—	—	1.9	mA
Write current ⁶	I _{WRITE}		—	—	3.7	mA
Supply voltage during flash erase and write	V _{FLASH}		1.62	—	3.6	V

Note:

- Flash data retention information is published in the Quarterly Quality and Reliability Report.
- From setting the ERASEPAGE bit in MSC_WRITECMD to 1 until the BUSY bit in MSC_STATUS is cleared to 0. Internal setup and hold times for flash control signals are included.
- Mass erase is issued by the CPU and erases all flash.
- Device erase is issued over the AAP interface and erases all flash, SRAM, the Lock Bit (LB) page, and the User data page Lock Word (ULW).
- From setting the DEVICEERASE bit in AAP_CMD to 1 until the ERASEBUSY bit in AAP_STATUS is cleared to 0. Internal setup and hold times for flash control signals are included.
- Measured at 25 °C.

4.1.12 General-Purpose I/O (GPIO)

Table 4.20. General-Purpose I/O (GPIO)

Parameter	Symbol	Test Condition	Min	Typ	Max	Unit
Input low voltage ¹	V_{IL}	GPIO pins	—	—	$IOVDD \cdot 0.3$	V
Input high voltage ¹	V_{IH}	GPIO pins	$IOVDD \cdot 0.7$	—	—	V
Output high voltage relative to IOVDD	V_{OH}	Sourcing 3 mA, $IOVDD \geq 3$ V, DRIVESTRENGTH ² = WEAK	$IOVDD \cdot 0.8$	—	—	V
		Sourcing 1.2 mA, $IOVDD \geq 1.62$ V, DRIVESTRENGTH ² = WEAK	$IOVDD \cdot 0.6$	—	—	V
		Sourcing 20 mA, $IOVDD \geq 3$ V, DRIVESTRENGTH ² = STRONG	$IOVDD \cdot 0.8$	—	—	V
		Sourcing 8 mA, $IOVDD \geq 1.62$ V, DRIVESTRENGTH ² = STRONG	$IOVDD \cdot 0.6$	—	—	V
Output low voltage relative to IOVDD	V_{OL}	Sinking 3 mA, $IOVDD \geq 3$ V, DRIVESTRENGTH ² = WEAK	—	—	$IOVDD \cdot 0.2$	V
		Sinking 1.2 mA, $IOVDD \geq 1.62$ V, DRIVESTRENGTH ² = WEAK	—	—	$IOVDD \cdot 0.4$	V
		Sinking 20 mA, $IOVDD \geq 3$ V, DRIVESTRENGTH ² = STRONG	—	—	$IOVDD \cdot 0.2$	V
		Sinking 8 mA, $IOVDD \geq 1.62$ V, DRIVESTRENGTH ² = STRONG	—	—	$IOVDD \cdot 0.4$	V
Input leakage current	I_{IOLEAK}	All GPIO except LFXO pins, $GPIO \leq IOVDD$, $T \leq 85$ °C	—	0.1	40	nA
		LFXO Pins, $GPIO \leq IOVDD$, $T \leq 85$ °C	—	0.1	60	nA
		All GPIO except LFXO pins, $GPIO \leq IOVDD$, $T > 85$ °C	—	—	150	nA
		LFXO Pins, $GPIO \leq IOVDD$, $T > 85$ °C	—	—	300	nA
Input leakage current on 5VTOL pads above IOVDD	$I_{5VTOLLEAK}$	$IOVDD < GPIO \leq IOVDD + 2$ V	—	3.3	15	μ A
I/O pin pull-up/pull-down resistor ³	R_{PUD}		30	40	65	k Ω
Pulse width of pulses removed by the glitch suppression filter	$t_{IOGLITCH}$		15	25	35	ns

Parameter	Symbol	Test Condition	Min	Typ	Max	Unit
Output fall time, From 70% to 30% of V_{IO}	t_{IOF}	$C_L = 50$ pF, DRIVESTRENGTH ² = STRONG, SLEWRATE ² = 0x6	—	1.8	—	ns
		$C_L = 50$ pF, DRIVESTRENGTH ² = WEAK, SLEWRATE ² = 0x6	—	4.5	—	ns
Output rise time, From 30% to 70% of V_{IO}	t_{IOR}	$C_L = 50$ pF, DRIVESTRENGTH ² = STRONG, SLEWRATE = 0x6 ²	—	2.2	—	ns
		$C_L = 50$ pF, DRIVESTRENGTH ² = WEAK, SLEWRATE ² = 0x6	—	7.4	—	ns
Required external series resistor on USB D+ and D-	R_{USB}		—	33 +/-10%	—	Ω

Note:

1. GPIO input threshold are proportional to the IOVDD supply, except for RESETn which is proportional to AVDD (or BU_VIN in backup mode).
2. In GPIO_Pn_CTRL register.
3. GPIO pull-ups are referenced to the IOVDD supply, except for RESETn, which connects to AVDD (or BU_VIN in backup mode).

4.1.13 Voltage Monitor (VMON)

Table 4.21. Voltage Monitor (VMON)

Parameter	Symbol	Test Condition	Min	Typ	Max	Unit
Supply current (including I _{SENSE})	I _{VMON}	In EM0 or EM1, 1 active channel, T ≤ 85 °C	—	6	11	μA
		In EM0 or EM1, 1 active channel, T > 85 °C	—	—	21	μA
		In EM0 or EM1, All channels active, T ≤ 85 °C	—	15	20	μA
		In EM0 or EM1, All channels active, T > 85 °C	—	—	32	μA
		In EM2, EM3 or EM4, 1 channel active and above threshold	—	62	—	nA
		In EM2, EM3 or EM4, 1 channel active and below threshold	—	62	—	nA
		In EM2, EM3 or EM4, All channels active and above threshold	—	99	—	nA
		In EM2, EM3 or EM4, All channels active and below threshold	—	99	—	nA
Loading of monitored supply	I _{SENSE}	In EM0 or EM1	—	2	—	μA
		In EM2, EM3 or EM4	—	2	—	nA
Threshold range	V _{VMON_RANGE}		1.62	—	3.4	V
Threshold step size	N _{VMON_STESP}	Coarse	—	200	—	mV
		Fine	—	20	—	mV
Response time	t _{VMON_RES}	Supply drops at 1V/μs rate	—	460	—	ns
Hysteresis	V _{VMON_HYST}		—	26	—	mV

4.1.14 Analog to Digital Converter (ADC)

Specified at 1 Msps, ADCCLK = 16 MHz, BIASPROG = 0, GPBIASACC = 0, unless otherwise indicated.

Table 4.22. Analog to Digital Converter (ADC)

Parameter	Symbol	Test Condition	Min	Typ	Max	Unit
Resolution	$V_{RESOLUTION}$		6	—	12	Bits
Input voltage range ¹	V_{ADCIN}	Single ended	—	—	V_{FS}	V
		Differential	$-V_{FS}/2$	—	$V_{FS}/2$	V
Input range of external reference voltage, single ended and differential	$V_{ADCREFIN_P}$		1	—	V_{AVDD}	V
Power supply rejection ²	$PSRR_{ADC}$	At DC	—	80	—	dB
Analog input common mode rejection ratio	$CMRR_{ADC}$	At DC	—	80	—	dB
Current from all supplies, using internal reference buffer. Continuous operation. $WAR_MUPMODE^3 = KEEPADC_WARM$	$I_{ADC_CONTINUOUS_LP}$	1 Msps / 16 MHz ADCCLK, BIASPROG = 0, GPBIASACC = 1 ⁴	—	270	350	μA
		250 kpsps / 4 MHz ADCCLK, BIASPROG = 6, GPBIASACC = 1 ⁴	—	125	—	μA
		62.5 kpsps / 1 MHz ADCCLK, BIASPROG = 15, GPBIASACC = 1 ⁴	—	80	—	μA
Current from all supplies, using internal reference buffer. Duty-cycled operation. $WAR_MUPMODE^3 = NORMAL$	$I_{ADC_NORMAL_LP}$	35 kpsps / 16 MHz ADCCLK, BIASPROG = 0, GPBIASACC = 1 ⁴	—	45	—	μA
		5 kpsps / 16 MHz ADCCLK BIASPROG = 0, GPBIASACC = 1 ⁴	—	8	—	μA
Current from all supplies, using internal reference buffer. Duty-cycled operation. $AWARMUPMODE^3 = KEEPINSTANDBY$ or $KEEPIN_SLOWACC$	$I_{ADC_STANDBY_LP}$	125 kpsps / 16 MHz ADCCLK, BIASPROG = 0, GPBIASACC = 1 ⁴	—	105	—	μA
		35 kpsps / 16 MHz ADCCLK, BIASPROG = 0, GPBIASACC = 1 ⁴	—	70	—	μA
Current from all supplies, using internal reference buffer. Continuous operation. $WAR_MUPMODE^3 = KEEPADC_WARM$	$I_{ADC_CONTINUOUS_HP}$	1 Msps / 16 MHz ADCCLK, BIASPROG = 0, GPBIASACC = 0 ⁴	—	325	—	μA
		250 kpsps / 4 MHz ADCCLK, BIASPROG = 6, GPBIASACC = 0 ⁴	—	175	—	μA
		62.5 kpsps / 1 MHz ADCCLK, BIASPROG = 15, GPBIASACC = 0 ⁴	—	125	—	μA
Current from all supplies, using internal reference buffer. Duty-cycled operation. $WAR_MUPMODE^3 = NORMAL$	$I_{ADC_NORMAL_HP}$	35 kpsps / 16 MHz ADCCLK, BIASPROG = 0, GPBIASACC = 0 ⁴	—	85	—	μA
		5 kpsps / 16 MHz ADCCLK BIASPROG = 0, GPBIASACC = 0 ⁴	—	16	—	μA
Current from all supplies, using internal reference buffer. Duty-cycled operation. $AWARMUPMODE^3 = KEEPINSTANDBY$ or $KEEPIN_SLOWACC$	$I_{ADC_STANDBY_HP}$	125 kpsps / 16 MHz ADCCLK, BIASPROG = 0, GPBIASACC = 0 ⁴	—	160	—	μA
		35 kpsps / 16 MHz ADCCLK, BIASPROG = 0, GPBIASACC = 0 ⁴	—	125	—	μA
Current from HFPERCLK	I_{ADC_CLK}	HFPERCLK = 16 MHz	—	180	—	μA

Parameter	Symbol	Test Condition	Min	Typ	Max	Unit
ADC clock frequency	f_{ADCCLK}		—	—	16	MHz
Throughput rate	f_{ADCRATE}		—	—	1	Msp/s
Conversion time ⁵	t_{ADCCONV}	6 bit	—	7	—	cycles
		8 bit	—	9	—	cycles
		12 bit	—	13	—	cycles
Startup time of reference generator and ADC core	t_{ADCSTART}	WARMUPMODE ³ = NORMAL	—	—	5	μs
		WARMUPMODE ³ = KEEPIN-STANDBY	—	—	2	μs
		WARMUPMODE ³ = KEEPINSLOWACC	—	—	1	μs
SNDR at 1Msp/s and $f_{\text{IN}} = 10\text{kHz}$	SNDR _{ADC}	Internal reference ⁶ , differential measurement	58	67	—	dB
		External reference ⁷ , differential measurement	—	68	—	dB
Spurious-free dynamic range (SFDR)	SFDR _{ADC}	1 MSamples/s, 10 kHz full-scale sine wave	—	75	—	dB
Differential non-linearity (DNL)	DNL _{ADC}	12 bit resolution, No missing codes	-1	—	2	LSB
Integral non-linearity (INL), End point method	INL _{ADC}	12 bit resolution	-6	—	6	LSB
Offset error	$V_{\text{ADCOFFSETERR}}$		-3	0	3	LSB
Gain error in ADC	V_{ADCGAIN}	Using internal reference	—	-0.2	3.5	%
		Using external reference	—	-1	—	%
Temperature sensor slope	$V_{\text{TS_SLOPE}}$		—	-1.84	—	mV/°C

Note:

1. The absolute voltage allowed at any ADC input is dictated by the power rail supplied to on-chip circuitry, and may be lower than the effective full scale voltage. All ADC inputs are limited to the ADC supply (AVDD or DVDD depending on EMU_PWRCTRL_ANASW). Any ADC input routed through the APORT will further be limited by the IOVDD supply to the pin.
2. PSRR is referenced to AVDD when ANASW=0 and to DVDD when ANASW=1 in EMU_PWRCTRL.
3. In ADCn_CTRL register.
4. In ADCn_BIASPROG register.
5. Derived from ADCCLK.
6. Internal reference option used corresponds to selection 2V5 in the SINGLECTRL_REF or SCANCTRL_REF register field. The differential input range with this configuration is $\pm 1.25\text{ V}$. Typical value is characterized using full-scale sine wave input. Minimum value is production-tested using sine wave input at 1.5 dB lower than full scale.
7. External reference is 1.25 V applied externally to ADCnEXTREFP, with the selection CONF in the SINGLECTRL_REF or SCANCTRL_REF register field and VREFP in the SINGLECTRLX_VREFSEL or SCANCTRLX_VREFSEL field. The differential input range with this configuration is $\pm 1.25\text{ V}$.

4.1.15 Analog Comparator (ACMP)

Table 4.23. Analog Comparator (ACMP)

Parameter	Symbol	Test Condition	Min	Typ	Max	Unit
Input voltage range	V_{ACMPIN}	ACMPVDD = ACMPn_CTRL_PWRSEL ¹	—	—	$V_{ACMPVDD}$	V
Supply voltage	$V_{ACMPVDD}$	BIASPROG ² ≤ 0x10 or FULL- BIAS ² = 0	1.8	—	$V_{VREGVDD_MAX}$	V
		0x10 < BIASPROG ² ≤ 0x20 and FULLBIAS ² = 1	2.1	—	$V_{VREGVDD_MAX}$	V
Active current not including voltage reference ³	I_{ACMP}	BIASPROG ² = 1, FULLBIAS ² = 0	—	75	—	nA
		BIASPROG ² = 0x10, FULLBIAS ² = 0	—	350	—	nA
		BIASPROG ² = 0x02, FULLBIAS ² = 1	—	6.5	—	μA
		BIASPROG ² = 0x20, FULLBIAS ² = 1	—	65	100	μA
Current consumption of inter- nal voltage reference ³	$I_{ACMPREF}$	VLP selected as input using 2.5 V Reference / 4 (0.625 V)	—	50	—	nA
		VLP selected as input using VDD	—	20	—	nA
		VBDIV selected as input using 1.25 V reference / 1	—	4.1	—	μA
		VADIV selected as input using VDD/1	—	2.4	—	μA

Parameter	Symbol	Test Condition	Min	Typ	Max	Unit
Hysteresis ($V_{CM} = 1.25\text{ V}$, $BIASPROG^2 = 0x10$, $FULLBIAS^2 = 1$)	$V_{ACMPHYST}$	$HYSTSEL^4 = HYST0$	-3	0	3	mV
		$HYSTSEL^4 = HYST1$	5	18	27	mV
		$HYSTSEL^4 = HYST2$	12	33	50	mV
		$HYSTSEL^4 = HYST3$	17	46	67	mV
		$HYSTSEL^4 = HYST4$	23	57	92	mV
		$HYSTSEL^4 = HYST5$	26	68	108	mV
		$HYSTSEL^4 = HYST6$	30	79	140	mV
		$HYSTSEL^4 = HYST7$	34	90	160	mV
		$HYSTSEL^4 = HYST8$	-3	0	3	mV
		$HYSTSEL^4 = HYST9$	-27	-18	-5	mV
		$HYSTSEL^4 = HYST10$	-50	-33	-12	mV
		$HYSTSEL^4 = HYST11$	-67	-45	-17	mV
		$HYSTSEL^4 = HYST12$	-92	-57	-23	mV
		$HYSTSEL^4 = HYST13$	-108	-67	-26	mV
		$HYSTSEL^4 = HYST14$	-140	-78	-30	mV
$HYSTSEL^4 = HYST15$	-160	-88	-34	mV		
Comparator delay ⁵	$t_{ACMPDELAY}$	$BIASPROG^2 = 1$, $FULLBIAS^2 = 0$	—	30	—	μs
		$BIASPROG^2 = 0x10$, $FULLBIAS^2 = 0$	—	3.7	—	μs
		$BIASPROG^2 = 0x02$, $FULLBIAS^2 = 1$	—	360	—	ns
		$BIASPROG^2 = 0x20$, $FULLBIAS^2 = 1$	—	35	—	ns
Offset voltage	$V_{ACMPOFFSET}$	$BIASPROG^2 = 0x10$, $FULLBIAS^2 = 1$	-35	—	35	mV
Reference voltage	$V_{ACMPREF}$	Internal 1.25 V reference	1	1.25	1.47	V
		Internal 2.5 V reference	1.98	2.5	2.8	V
Capacitive sense internal resistance	R_{CSRES}	$CSRESSEL^6 = 0$	—	infinite	—	k Ω
		$CSRESSEL^6 = 1$	—	15	—	k Ω
		$CSRESSEL^6 = 2$	—	27	—	k Ω
		$CSRESSEL^6 = 3$	—	39	—	k Ω
		$CSRESSEL^6 = 4$	—	51	—	k Ω
		$CSRESSEL^6 = 5$	—	100	—	k Ω
		$CSRESSEL^6 = 6$	—	162	—	k Ω
		$CSRESSEL^6 = 7$	—	235	—	k Ω

Parameter	Symbol	Test Condition	Min	Typ	Max	Unit
Note:						
1. ACMPVDD is a supply chosen by the setting in ACMPn_CTRL_PWRSEL and may be IOVDD, AVDD or DVDD.						
2. In ACMPn_CTRL register.						
3. The total ACMP current is the sum of the contributions from the ACMP and its internal voltage reference. $I_{ACMPTOTAL} = I_{ACMP} + I_{ACMPREF}$.						
4. In ACMPn_HYSTERESIS registers.						
5. ± 100 mV differential drive.						
6. In ACMPn_INPUTSEL register.						

4.1.16 Digital to Analog Converter (VDAC)

DRIVESTRENGTH = 2 unless otherwise specified. Primary VDAC output.

Table 4.24. Digital to Analog Converter (VDAC)

Parameter	Symbol	Test Condition	Min	Typ	Max	Unit
Output voltage	V _{DACOUT}	Single-Ended	0	—	V _{VREF}	V
		Differential ¹	-V _{VREF}	—	V _{VREF}	V
Current consumption including references (2 channels) ²	I _{DAC}	500 ksps, 12-bit, DRIVESTRENGTH = 2, REFSEL = 4	—	402	—	μA
		44.1 ksps, 12-bit, DRIVESTRENGTH = 1, REFSEL = 4	—	88	—	μA
		200 Hz refresh rate, 12-bit Sample-Off mode in EM2, DRIVESTRENGTH = 2, REFSEL = 4, SETTLETIME = 0x02, WARMUP-TIME = 0x0A	—	2	—	μA
Current from HFPERCLK ³	I _{DAC_CLK}		—	6.6	—	μA/MHz
Sample rate	SR _{DAC}		—	—	500	ksps
DAC clock frequency	f _{DAC}		—	—	1	MHz
Conversion time	t _{DACCONV}	f _{DAC} = 1MHz	2	—	—	μs
Settling time	t _{DACSETTLE}	50% fs step settling to 5 LSB	—	2.5	—	μs
Startup time	t _{DACSTARTUP}	Enable to 90% fs output, settling to 10 LSB	—	—	12	μs
Output impedance	R _{OUT}	DRIVESTRENGTH = 2, 0.4 V ≤ V _{OUT} ≤ V _{OPA} - 0.4 V, -8 mA < I _{OUT} < 8 mA, Full supply range	—	2	—	Ω
		DRIVESTRENGTH = 0 or 1, 0.4 V ≤ V _{OUT} ≤ V _{OPA} - 0.4 V, -400 μA < I _{OUT} < 400 μA, Full supply range	—	2	—	Ω
		DRIVESTRENGTH = 2, 0.1 V ≤ V _{OUT} ≤ V _{OPA} - 0.1 V, -2 mA < I _{OUT} < 2 mA, Full supply range	—	2	—	Ω
		DRIVESTRENGTH = 0 or 1, 0.1 V ≤ V _{OUT} ≤ V _{OPA} - 0.1 V, -100 μA < I _{OUT} < 100 μA, Full supply range	—	2	—	Ω
Power supply rejection ratio ⁴	PSRR	V _{out} = 50% fs. DC	—	65.5	—	dB

Parameter	Symbol	Test Condition	Min	Typ	Max	Unit
Signal to noise and distortion ratio (1 kHz sine wave), Noise band limited to 250 kHz	SNDR _{DAC}	500 ksps, single-ended, internal 1.25V reference	—	60.4	—	dB
		500 ksps, single-ended, internal 2.5V reference	—	61.6	—	dB
		500 ksps, single-ended, 3.3V VDD reference	—	64.0	—	dB
		500 ksps, differential, internal 1.25V reference	—	63.3	—	dB
		500 ksps, differential, internal 2.5V reference	—	64.4	—	dB
		500 ksps, differential, 3.3V VDD reference	—	65.8	—	dB
Signal to noise and distortion ratio (1 kHz sine wave), Noise band limited to 22 kHz	SNDR _{DAC_BAND}	500 ksps, single-ended, internal 1.25V reference	—	65.3	—	dB
		500 ksps, single-ended, internal 2.5V reference	—	66.7	—	dB
		500 ksps, single-ended, 3.3V VDD reference	—	70.0	—	dB
		500 ksps, differential, internal 1.25V reference	—	67.8	—	dB
		500 ksps, differential, internal 2.5V reference	—	69.0	—	dB
		500 ksps, differential, 3.3V VDD reference	—	68.5	—	dB
Total harmonic distortion	THD		—	70.2	—	dB
Differential non-linearity ⁵	DNL _{DAC}		-1.25	—	1.25	LSB
Integral non-linearity	INL _{DAC}		-4	—	4	LSB
Offset error ⁶	V _{OFFSET}	T = 25 °C	-8	—	8	mV
		Across operating temperature range	-25	—	25	mV
Gain error ⁶	V _{GAIN}	T = 25 °C, Low-noise internal reference (REFSEL = 1V25LN or 2V5LN)	-2.5	—	2.5	%
		Across operating temperature range, Low-noise internal reference (REFSEL = 1V25LN or 2V5LN)	-3.5	—	3.5	%
External load capacitance, OUTSCALE=0	C _{LOAD}		—	—	75	pF

Parameter	Symbol	Test Condition	Min	Typ	Max	Unit
Note:						
<ol style="list-style-type: none"> 1. In differential mode, the output is defined as the difference between two single-ended outputs. Absolute voltage on each output is limited to the single-ended range. 2. Supply current specifications are for VDAC circuitry operating with static output only and do not include current required to drive the load. 3. Current from HUPERCLK is dependent on HUPERCLK frequency. This current contributes to the total supply current used when the clock to the DAC peripheral is enabled in the CMU. 4. PSRR calculated as $20 * \log_{10}(\Delta V_{DD} / \Delta V_{OUT})$, VDAC output at 90% of full scale 5. Entire range is monotonic and has no missing codes. 6. Gain is calculated by measuring the slope from 10% to 90% of full scale. Offset is calculated by comparing actual VDAC output at 10% of full scale to ideal VDAC output at 10% of full scale with the measured gain. 						

4.1.17 Current Digital to Analog Converter (IDAC)

Table 4.25. Current Digital to Analog Converter (IDAC)

Parameter	Symbol	Test Condition	Min	Typ	Max	Unit
Number of ranges	N_{IDAC_RANGES}		—	4	—	ranges
Output current	I_{IDAC_OUT}	RANGESEL ¹ = RANGE0	0.05	—	1.6	μA
		RANGESEL ¹ = RANGE1	1.6	—	4.7	μA
		RANGESEL ¹ = RANGE2	0.5	—	16	μA
		RANGESEL ¹ = RANGE3	2	—	64	μA
Linear steps within each range	N_{IDAC_STEPS}		—	32	—	steps
Step size	SS_{IDAC}	RANGESEL ¹ = RANGE0	—	50	—	nA
		RANGESEL ¹ = RANGE1	—	100	—	nA
		RANGESEL ¹ = RANGE2	—	500	—	nA
		RANGESEL ¹ = RANGE3	—	2	—	μA
Total accuracy, STEPSEL ¹ = 0x10	ACC_{IDAC}	EM0 or EM1, AVDD=3.3 V, T = 25 °C	-3	—	3	%
		EM0 or EM1, Across operating temperature range	-18	—	22	%
		EM2 or EM3, Source mode, RANGESEL ¹ = RANGE0, AVDD=3.3 V, T = 25 °C	—	-2.7	—	%
		EM2 or EM3, Source mode, RANGESEL ¹ = RANGE1, AVDD=3.3 V, T = 25 °C	—	-2.5	—	%
		EM2 or EM3, Source mode, RANGESEL ¹ = RANGE2, AVDD=3.3 V, T = 25 °C	—	-1.5	—	%
		EM2 or EM3, Source mode, RANGESEL ¹ = RANGE3, AVDD=3.3 V, T = 25 °C	—	-1.0	—	%
		EM2 or EM3, Sink mode, RANGESEL ¹ = RANGE0, AVDD=3.3 V, T = 25 °C	—	-1.1	—	%
		EM2 or EM3, Sink mode, RANGESEL ¹ = RANGE1, AVDD=3.3 V, T = 25 °C	—	-1.1	—	%
		EM2 or EM3, Sink mode, RANGESEL ¹ = RANGE2, AVDD=3.3 V, T = 25 °C	—	-0.9	—	%
		EM2 or EM3, Sink mode, RANGESEL ¹ = RANGE3, AVDD=3.3 V, T = 25 °C	—	-0.9	—	%

Parameter	Symbol	Test Condition	Min	Typ	Max	Unit
Start up time	t_{IDAC_SU}	Output within 1% of steady state value	—	5	—	μs
Settling time, (output settled within 1% of steady state value),	t_{IDAC_SETTLE}	Range setting is changed	—	5	—	μs
		Step value is changed	—	1	—	μs
Current consumption ²	I_{IDAC}	EM0 or EM1 Source mode, excluding output current, Across operating temperature range	—	11	28	μA
		EM0 or EM1 Sink mode, excluding output current, Across operating temperature range	—	13	30	μA
		EM2 or EM3 Source mode, excluding output current, T = 25 °C	—	0.05	—	μA
		EM2 or EM3 Sink mode, excluding output current, T = 25 °C	—	0.07	—	μA
		EM2 or EM3 Source mode, excluding output current, T \geq 85 °C	—	11	—	μA
		EM2 or EM3 Sink mode, excluding output current, T \geq 85 °C	—	13	—	μA
Output voltage compliance in source mode, source current change relative to current sourced at 0 V	I_{COMP_SRC}	RANGESEL ¹ = RANGE0, output voltage = $\min(V_{IOVDD}, V_{AVDD}^2 - 100 \text{ mV})$	—	0.11	—	%
		RANGESEL ¹ = RANGE1, output voltage = $\min(V_{IOVDD}, V_{AVDD}^2 - 100 \text{ mV})$	—	0.06	—	%
		RANGESEL ¹ = RANGE2, output voltage = $\min(V_{IOVDD}, V_{AVDD}^2 - 150 \text{ mV})$	—	0.04	—	%
		RANGESEL ¹ = RANGE3, output voltage = $\min(V_{IOVDD}, V_{AVDD}^2 - 250 \text{ mV})$	—	0.03	—	%
Output voltage compliance in sink mode, sink current change relative to current sunk at IOVDD	I_{COMP_SINK}	RANGESEL ¹ = RANGE0, output voltage = 100 mV	—	0.29	—	%
		RANGESEL ¹ = RANGE1, output voltage = 100 mV	—	0.27	—	%
		RANGESEL ¹ = RANGE2, output voltage = 150 mV	—	0.12	—	%
		RANGESEL ¹ = RANGE3, output voltage = 250 mV	—	0.03	—	%

Note:

1. In IDAC_CURPROG register.
2. The IDAC is supplied by either AVDD, DVDD, or IOVDD based on the setting of ANASW in the EMU_PWRCTRL register and PWRSEL in the IDAC_CTRL register. Setting PWRSEL to 1 selects IOVDD. With PWRSEL cleared to 0, ANASW selects between AVDD (0) and DVDD (1).

4.1.18 Capacitive Sense (CSEN)

Table 4.26. Capacitive Sense (CSEN)

Parameter	Symbol	Test Condition	Min	Typ	Max	Unit
Single conversion time (1x accumulation)	t _{CNV}	12-bit SAR Conversions	—	20.2	—	μs
		16-bit SAR Conversions	—	26.4	—	μs
		Delta Modulation Conversion (single comparison)	—	1.55	—	μs
Maximum external capacitive load	C _{EXTMAX}	IREFPROG=7 (Gain = 1x), including routing parasitics	—	68	—	pF
		IREFPROG=0 (Gain = 10x), including routing parasitics	—	680	—	pF
Maximum external series impedance	R _{EXTMAX}		—	1	—	kΩ
Supply current, EM2 bonded conversions, WARMUP-MODE=NORMAL, WARMUPCNT=0	I _{CSEN_BOND}	12-bit SAR conversions, 20 ms conversion rate, IREFPROG=7 (Gain = 1x), 10 channels bonded (total capacitance of 330 pF) ¹	—	326	—	nA
		Delta Modulation conversions, 20 ms conversion rate, IREFPROG=7 (Gain = 1x), 10 channels bonded (total capacitance of 330 pF) ¹	—	226	—	nA
		12-bit SAR conversions, 200 ms conversion rate, IREFPROG=7 (Gain = 1x), 10 channels bonded (total capacitance of 330 pF) ¹	—	33	—	nA
		Delta Modulation conversions, 200 ms conversion rate, IREFPROG=7 (Gain = 1x), 10 channels bonded (total capacitance of 330 pF) ¹	—	25	—	nA
Supply current, EM2 scan conversions, WARMUP-MODE=NORMAL, WARMUPCNT=0	I _{CSEN_EM2}	12-bit SAR conversions, 20 ms scan rate, IREFPROG=0 (Gain = 10x), 8 samples per scan ¹	—	690	—	nA
		Delta Modulation conversions, 20 ms scan rate, 8 comparisons per sample (DMCR = 1, DMR = 2), IREFPROG=0 (Gain = 10x), 8 samples per scan ¹	—	515	—	nA
		12-bit SAR conversions, 200 ms scan rate, IREFPROG=0 (Gain = 10x), 8 samples per scan ¹	—	79	—	nA
		Delta Modulation conversions, 200 ms scan rate, 8 comparisons per sample (DMCR = 1, DMR = 2), IREFPROG=0 (Gain = 10x), 8 samples per scan ¹	—	57	—	nA

Parameter	Symbol	Test Condition	Min	Typ	Max	Unit
Supply current, continuous conversions, WARMUP-MODE=KEEP_CSEN_WARM	I _{CSEN_ACTIVE}	SAR or Delta Modulation conversions of 33 pF capacitor, IRE-FPROG=0 (Gain = 10x), always on	—	90.5	—	μA
HFPERCLK supply current	I _{CSEN_HFPERCLK}	Current contribution from HFPERCLK when clock to CSEN block is enabled.	—	2.25	—	μA/MHz

Note:

- Current is specified with a total external capacitance of 33 pF per channel. Average current is dependent on how long the peripheral is actively sampling channels within the scan period, and scales with the number of samples acquired. Supply current for a specific application can be estimated by multiplying the current per sample by the total number of samples per period (total_current = single_sample_current * (number_of_channels * accumulation)).

4.1.19 Operational Amplifier (OPAMP)

Unless otherwise indicated, specified conditions are: Non-inverting input configuration, VDD = 3.3 V, DRIVESTRENGTH = 2, MAIN-OUTEN = 1, C_{LOAD} = 75 pF with OUTSCALE = 0, or C_{LOAD} = 37.5 pF with OUTSCALE = 1. Unit gain buffer and 3X-gain connection as specified in table footnotes^{1 2}.

Table 4.27. Operational Amplifier (OPAMP)

Parameter	Symbol	Test Condition	Min	Typ	Max	Unit
Supply voltage (from AVDD)	V _{OPA}	HCMDIS = 0, Rail-to-rail input range	2	—	3.8	V
		HCMDIS = 1	1.62	—	3.8	V
Input voltage	V _{IN}	HCMDIS = 0, Rail-to-rail input range	V _{VSS}	—	V _{OPA}	V
		HCMDIS = 1	V _{VSS}	—	V _{OPA} -1.2	V
Input impedance	R _{IN}		100	—	—	MΩ
Output voltage	V _{OUT}		V _{VSS}	—	V _{OPA}	V
Load capacitance ³	C _{LOAD}	OUTSCALE = 0	—	—	75	pF
		OUTSCALE = 1	—	—	37.5	pF
Output impedance	R _{OUT}	DRIVESTRENGTH = 2 or 3, 0.4 V ≤ V _{OUT} ≤ V _{OPA} - 0.4 V, -8 mA < I _{OUT} < 8 mA, Buffer connection, Full supply range	—	0.25	—	Ω
		DRIVESTRENGTH = 0 or 1, 0.4 V ≤ V _{OUT} ≤ V _{OPA} - 0.4 V, -400 μA < I _{OUT} < 400 μA, Buffer connection, Full supply range	—	0.6	—	Ω
		DRIVESTRENGTH = 2 or 3, 0.1 V ≤ V _{OUT} ≤ V _{OPA} - 0.1 V, -2 mA < I _{OUT} < 2 mA, Buffer connection, Full supply range	—	0.4	—	Ω
		DRIVESTRENGTH = 0 or 1, 0.1 V ≤ V _{OUT} ≤ V _{OPA} - 0.1 V, -100 μA < I _{OUT} < 100 μA, Buffer connection, Full supply range	—	1	—	Ω
Internal closed-loop gain	G _{CL}	Buffer connection	0.99	1	1.01	-
		3x Gain connection	2.93	2.99	3.05	-
		16x Gain connection	15.07	15.7	16.33	-
Active current ⁴	I _{OPA}	DRIVESTRENGTH = 3, OUTSCALE = 0	—	580	—	μA
		DRIVESTRENGTH = 2, OUTSCALE = 0	—	176	—	μA
		DRIVESTRENGTH = 1, OUTSCALE = 0	—	13	—	μA
		DRIVESTRENGTH = 0, OUTSCALE = 0	—	4.7	—	μA

Parameter	Symbol	Test Condition	Min	Typ	Max	Unit
Open-loop gain	G _{OL}	DRIVESTRENGTH = 3	—	135	—	dB
		DRIVESTRENGTH = 2	—	137	—	dB
		DRIVESTRENGTH = 1	—	121	—	dB
		DRIVESTRENGTH = 0	—	109	—	dB
Loop unit-gain frequency ⁵	UGF	DRIVESTRENGTH = 3, Buffer connection	—	3.38	—	MHz
		DRIVESTRENGTH = 2, Buffer connection	—	0.9	—	MHz
		DRIVESTRENGTH = 1, Buffer connection	—	132	—	kHz
		DRIVESTRENGTH = 0, Buffer connection	—	34	—	kHz
		DRIVESTRENGTH = 3, 3x Gain connection	—	2.57	—	MHz
		DRIVESTRENGTH = 2, 3x Gain connection	—	0.71	—	MHz
		DRIVESTRENGTH = 1, 3x Gain connection	—	113	—	kHz
		DRIVESTRENGTH = 0, 3x Gain connection	—	28	—	kHz
Phase margin	PM	DRIVESTRENGTH = 3, Buffer connection	—	67	—	°
		DRIVESTRENGTH = 2, Buffer connection	—	69	—	°
		DRIVESTRENGTH = 1, Buffer connection	—	63	—	°
		DRIVESTRENGTH = 0, Buffer connection	—	68	—	°
Output voltage noise	N _{OUT}	DRIVESTRENGTH = 3, Buffer connection, 10 Hz - 10 MHz	—	146	—	μVrms
		DRIVESTRENGTH = 2, Buffer connection, 10 Hz - 10 MHz	—	163	—	μVrms
		DRIVESTRENGTH = 1, Buffer connection, 10 Hz - 1 MHz	—	170	—	μVrms
		DRIVESTRENGTH = 0, Buffer connection, 10 Hz - 1 MHz	—	176	—	μVrms
		DRIVESTRENGTH = 3, 3x Gain connection, 10 Hz - 10 MHz	—	313	—	μVrms
		DRIVESTRENGTH = 2, 3x Gain connection, 10 Hz - 10 MHz	—	271	—	μVrms
		DRIVESTRENGTH = 1, 3x Gain connection, 10 Hz - 1 MHz	—	247	—	μVrms
		DRIVESTRENGTH = 0, 3x Gain connection, 10 Hz - 1 MHz	—	245	—	μVrms

Parameter	Symbol	Test Condition	Min	Typ	Max	Unit
Slew rate ⁶	SR	DRIVESTRENGTH = 3, INCBW=1 ⁷	—	4.7	—	V/μs
		DRIVESTRENGTH = 3, INCBW=0	—	1.5	—	V/μs
		DRIVESTRENGTH = 2, INCBW=1 ⁷	—	1.27	—	V/μs
		DRIVESTRENGTH = 2, INCBW=0	—	0.42	—	V/μs
		DRIVESTRENGTH = 1, INCBW=1 ⁷	—	0.17	—	V/μs
		DRIVESTRENGTH = 1, INCBW=0	—	0.058	—	V/μs
		DRIVESTRENGTH = 0, INCBW=1 ⁷	—	0.044	—	V/μs
		DRIVESTRENGTH = 0, INCBW=0	—	0.015	—	V/μs
Startup time ⁸	T _{START}	DRIVESTRENGTH = 2	—	—	12	μs
Input offset voltage	V _{OSI}	DRIVESTRENGTH = 2 or 3, T = 25 °C	-3	—	3	mV
		DRIVESTRENGTH = 1 or 0, T = 25 °C	-3	—	3	mV
		DRIVESTRENGTH = 2 or 3, across operating temperature range	-12	—	12	mV
		DRIVESTRENGTH = 1 or 0, across operating temperature range	-30	—	30	mV
DC power supply rejection ratio ⁹	PSRR _{DC}	Input referred	—	70	—	dB
DC common-mode rejection ratio ⁹	CMRR _{DC}	Input referred	—	70	—	dB
Total harmonic distortion	THD _{OPA}	DRIVESTRENGTH = 2, 3x Gain connection, 1 kHz, V _{OUT} = 0.1 V to V _{OPA} - 0.1 V	—	90	—	dB
		DRIVESTRENGTH = 0, 3x Gain connection, 0.1 kHz, V _{OUT} = 0.1 V to V _{OPA} - 0.1 V	—	90	—	dB

Parameter	Symbol	Test Condition	Min	Typ	Max	Unit
Note:						
1. Specified configuration for Unit gain buffer configuration is: INCBW = 0, HCMDIS = 0, RESINSEL = DISABLE. $V_{INPUT} = 0.5\text{ V}$, $V_{OUTPUT} = 0.5\text{ V}$.						
2. Specified configuration for 3X-Gain configuration is: INCBW = 1, HCMDIS = 1, RESINSEL = VSS, $V_{INPUT} = 0.5\text{ V}$, $V_{OUTPUT} = 1.5\text{ V}$. Nominal voltage gain is 3.						
3. If the maximum C_{LOAD} is exceeded, an isolation resistor is required for stability. See AN0038 for more information.						
4. Current into the load resistor is excluded. When the OPAMP is connected with closed-loop gain > 1, there will be extra current to drive the resistor feedback network. The internal resistor feedback network has total resistance of 143.5 kOhm, which will cause another ~10 μA current when the OPAMP drives 1.5 V between output and ground.						
5. In unit gain connection, UGF is the gain-bandwidth product of the OPAMP. In 3x Gain connection, UGF is the gain-bandwidth product of the OPAMP and 1/3 attenuation of the feedback network.						
6. Step between 0.2V and $V_{OPA}-0.2\text{V}$, 10%-90% rising/falling range.						
7. When INCBW is set to 1 the OPAMP bandwidth is increased. This is allowed only when the non-inverting close-loop gain is ≥ 3 , or the OPAMP may not be stable.						
8. From enable to output settled. In sample-and-off mode, RC network after OPAMP will contribute extra delay. Settling error < 1mV.						
9. When HCMDIS=1 and input common mode transitions the region from $V_{OPA}-1.4\text{V}$ to $V_{OPA}-1\text{V}$, input offset will change. PSRR and CMRR specifications do not apply to this transition region.						

4.1.20 LCD Driver

Table 4.28. LCD Driver

Parameter	Symbol	Test Condition	Min	Typ	Max	Unit
Frame rate	f_{LCDFR}		30	—	100	Hz
LCD supply range ¹	V_{LCDIN}		1.8	—	3.8	V
LCD output voltage range	V_{LCD}	Current source mode, No external LCD capacitor	2.0	—	$V_{LCDIN}-0.4$	V
		Step-down mode with external LCD capacitor	2.0	—	V_{LCDIN}	V
		Charge pump mode with external LCD capacitor	2.0	—	1.9 * V_{LCDIN}	V
Contrast control step size	$STEP_{CONTRAST}$	Current source mode	—	64	—	mV
		Charge pump or Step-down mode	—	43	—	mV
Contrast control step accuracy ²	$ACC_{CONTRAST}$		—	+/-4	—	%
Note:						
1. V_{LCDIN} is selectable between the AVDD or DVDD supply pins, depending on EMU_PWRCTRL_ANASW.						
2. Step size accuracy is measured relative to the typical step size, and typ value represents one standard deviation.						

4.1.21 Pulse Counter (PCNT)

Table 4.29. Pulse Counter (PCNT)

Parameter	Symbol	Test Condition	Min	Typ	Max	Unit
Input frequency	F _{IN}	Asynchronous Single and Quadrature Modes	—	—	20	MHz
		Sampled Modes with Debounce filter set to 0.	—	—	8	kHz

4.1.22 Analog Port (APORT)

Table 4.30. Analog Port (APORT)

Parameter	Symbol	Test Condition	Min	Typ	Max	Unit
Supply current ^{1 2}	I _{APORT}	Operation in EM0/EM1	—	7	—	μA
		Operation in EM2/EM3	—	63	—	nA

Note:

1. Supply current increase that occurs when an analog peripheral requests access to APORT. This current is not included in reported peripheral currents. Additional peripherals requesting access to APORT do not incur further current.
2. Specified current is for continuous APORT operation. In applications where the APORT is not requested continuously (e.g. periodic ACMP requests from LESENSE in EM2), the average current requirements can be estimated by multiplying the duty cycle of the requests by the specified continuous current number.

4.1.23 I2C

4.1.23.1 I2C Standard-mode (Sm)¹Table 4.31. I2C Standard-mode (Sm)¹

Parameter	Symbol	Test Condition	Min	Typ	Max	Unit
SCL clock frequency ²	f _{SCL}		0	—	100	kHz
SCL clock low time	t _{LOW}		4.7	—	—	μs
SCL clock high time	t _{HIGH}		4	—	—	μs
SDA set-up time	t _{SU_DAT}		250	—	—	ns
SDA hold time ³	t _{HD_DAT}		100	—	3450	ns
Repeated START condition set-up time	t _{SU_STA}		4.7	—	—	μs
(Repeated) START condition hold time	t _{HD_STA}		4	—	—	μs
STOP condition set-up time	t _{SU_STO}		4	—	—	μs
Bus free time between a STOP and START condition	t _{BUF}		4.7	—	—	μs

Note:

1. For CLHR set to 0 in the I2Cn_CTRL register.
2. For the minimum HPPERCLK frequency required in Standard-mode, refer to the I2C chapter in the reference manual.
3. The maximum SDA hold time (t_{HD_DAT}) needs to be met only when the device does not stretch the low time of SCL (t_{LOW}).

4.1.23.2 I2C Fast-mode (Fm)¹Table 4.32. I2C Fast-mode (Fm)¹

Parameter	Symbol	Test Condition	Min	Typ	Max	Unit
SCL clock frequency ²	f _{SCL}		0	—	400	kHz
SCL clock low time	t _{LOW}		1.3	—	—	μs
SCL clock high time	t _{HIGH}		0.6	—	—	μs
SDA set-up time	t _{SU_DAT}		100	—	—	ns
SDA hold time ³	t _{HD_DAT}		100	—	900	ns
Repeated START condition set-up time	t _{SU_STA}		0.6	—	—	μs
(Repeated) START condition hold time	t _{HD_STA}		0.6	—	—	μs
STOP condition set-up time	t _{SU_STO}		0.6	—	—	μs
Bus free time between a STOP and START condition	t _{BUF}		1.3	—	—	μs

Note:

1. For CLHR set to 1 in the I2Cn_CTRL register.
2. For the minimum HPPERCLK frequency required in Fast-mode, refer to the I2C chapter in the reference manual.
3. The maximum SDA hold time (t_{HD,DAT}) needs to be met only when the device does not stretch the low time of SCL (t_{LOW}).

4.1.23.3 I2C Fast-mode Plus (Fm+)¹

Table 4.33. I2C Fast-mode Plus (Fm+)¹

Parameter	Symbol	Test Condition	Min	Typ	Max	Unit
SCL clock frequency ²	f _{SCL}		0	—	1000	kHz
SCL clock low time	t _{LOW}		0.5	—	—	μs
SCL clock high time	t _{HIGH}		0.26	—	—	μs
SDA set-up time	t _{SU_DAT}		50	—	—	ns
SDA hold time	t _{HD_DAT}		100	—	—	ns
Repeated START condition set-up time	t _{SU_STA}		0.26	—	—	μs
(Repeated) START condition hold time	t _{HD_STA}		0.26	—	—	μs
STOP condition set-up time	t _{SU_STO}		0.26	—	—	μs
Bus free time between a STOP and START condition	t _{BUF}		0.5	—	—	μs

Note:

1. For CLHR set to 0 or 1 in the I2Cn_CTRL register.
2. For the minimum HPPERCLK frequency required in Fast-mode Plus, refer to the I2C chapter in the reference manual.

4.1.24 USART SPI

SPI Master Timing

Table 4.34. SPI Master Timing

Parameter	Symbol	Test Condition	Min	Typ	Max	Unit
SCLK period ^{1 2 3}	t _{SCLK}	All USARTs except USART2	2 * t _{HFPERCLK}	—	—	ns
		USART2	2 * t _{HFPERBCLK}	—	—	ns
CS to MOSI ^{1 2}	t _{CS_MO}	USART2, location 4, IOVDD = 1.8 V	-4	—	6	ns
		USART2, location 4, IOVDD = 3.0 V	-2.5	—	5	ns
		USART2, location 5, IOVDD = 1.8 V	-6.5	—	7.5	ns
		USART2, location 5, IOVDD = 3.0 V	-5.5	—	6	ns
		All other USARTs and locations, IOVDD = 1.8 V	-10.5	—	9	ns
		All other USARTs and locations, IOVDD = 3.0 V	-8.5	—	7.5	ns
SCLK to MOSI ^{1 2}	t _{SCLK_MO}	USART2, location 4, IOVDD = 1.8 V	-1	—	6	ns
		USART2, location 4, IOVDD = 3.0 V	-1	—	5.5	ns
		USART2, location 5, IOVDD = 1.8 V	-3	—	4	ns
		USART2, location 5, IOVDD = 3.0 V	-2.5	—	2.5	ns
		All other USARTs and locations, IOVDD = 1.8 V	-7	—	8.5	ns
		All other USARTs and locations, IOVDD = 3.0 V	-6	—	9	ns
MISO setup time ^{1 2}	t _{SU_MI}	USART2, location 4, IOVDD = 1.8 V	41	—	—	ns
		USART2, location 4, IOVDD = 3.0 V	32	—	—	ns
		USART2, location 5, IOVDD = 1.8 V	49	—	—	ns
		USART2, location 5, IOVDD = 3.0 V	30	—	—	ns
		All other USARTs and locations, IOVDD = 1.8 V	51	—	—	ns
		All other USARTs and locations, IOVDD = 3.0 V	32	—	—	ns

Parameter	Symbol	Test Condition	Min	Typ	Max	Unit
MISO hold time ^{1 2}	t_{H_MI}	USART2, location 4, IOVDD = 1.8 V	-12	—	—	ns
		USART2, location 4, IOVDD = 3.0 V	-12	—	—	ns
		USART2, location 5, IOVDD = 1.8 V	-9.5	—	—	ns
		USART2, location 5, IOVDD = 3.0 V	-9.5	—	—	ns
		All other USARTs and locations, IOVDD = 1.8 V	-10.5	—	—	ns
		All other USARTs and locations, IOVDD = 3.0 V	-10.5	—	—	ns

Note:

1. Applies for both CLKPHA = 0 and CLKPHA = 1 (figure only shows CLKPHA = 0).
2. Measurement done with 8 pF output loading at 10% and 90% of V_{DD} (figure shows 50% of V_{DD}).
3. $t_{HFPERCLK}$ is one period of the selected HFPERCLK.



Figure 4.1. SPI Master Timing Diagram

SPI Slave Timing

Table 4.35. SPI Slave Timing

Parameter	Symbol	Test Condition	Min	Typ	Max	Unit
SCLK period ^{1 2 3}	t_{SCLK}		6 * $t_{HFPERCLK}$	—	—	ns
SCLK high time ^{1 2 3}	t_{SCLK_HI}		2.5 * $t_{HFPERCLK}$	—	—	ns
SCLK low time ^{1 2 3}	t_{SCLK_LO}		2.5 * $t_{HFPERCLK}$	—	—	ns
CS active to MISO ^{1 2}	$t_{CS_ACT_MI}$		22	—	54	ns
CS disable to MISO ^{1 2}	$t_{CS_DIS_MI}$		20	—	175	ns
MOSI setup time ^{1 2}	t_{SU_MO}		6	—	—	ns
MOSI hold time ^{1 2 3}	t_{H_MO}		7	—	—	ns
SCLK to MISO ^{1 2 3}	t_{SCLK_MI}		17 + 1.5 * $t_{HFPERCLK}$	—	41 + 2.5 * $t_{HFPERCLK}$	ns

Note:

1. Applies for both CLKPHA = 0 and CLKPHA = 1 (figure only shows CLKPHA = 0).
2. Measurement done with 8 pF output loading at 10% and 90% of V_{DD} (figure shows 50% of V_{DD}).
3. $t_{HFPERCLK}$ is one period of the selected HFPERCLK.



Figure 4.2. SPI Slave Timing Diagram

4.1.25 External Bus Interface (EBI)

EBI Write Enable Output Timing

Timing applies to both EBI_WEn and EBI_NANDWEn for all addressing modes and both polarities. All numbers are based on route locations 0,1,2 only (with all EBI alternate functions using the same location at the same time). Timing is specified at 10% and 90% of IOVDD, 25 pF external loading, and slew rate for all GPIO set to 6.

Table 4.36. EBI Write Enable Timing

Parameter	Symbol	Test Condition	Min	Typ	Max	Unit
Output hold time, from trailing EBI_WEn / EBI_NANDWEn edge to EBI_AD, EBI_A, EBI_CS _n , EBI_BL _n invalid	t _{OH_WEn}	IOVDD ≥ 1.62 V	-22 + (WRHOLD * t _{HFCOR-ECLK})	—	—	ns
		IOVDD ≥ 3.0 V	-14 + (WRHOLD * t _{HFCOR-ECLK})	—	—	ns
Output setup time, from EBI_AD, EBI_A, EBI_CS _n , EBI_BL _n valid to leading EBI_WEn / EBI_NANDWEn edge ¹	t _{OSU_WEn}	IOVDD ≥ 1.62 V	-12 + (WRSET-UP * t _{HFCOR-ECLK})	—	—	ns
		IOVDD ≥ 3.0 V	-10 + (WRSET-UP * t _{HFCOR-ECLK})	—	—	ns
EBI_WEn / EBI_NANDWEn pulse width ¹	t _{WIDTH_WEn}	IOVDD ≥ 1.62 V	-6 + (MAX(1, WRSTRB) * t _{HFCOR-ECLK})	—	—	ns
		IOVDD ≥ 3.0 V	-5 + (MAX(1, WRSTRB) * t _{HFCOR-ECLK})	—	—	ns

Note:

- The figure shows the timing for the case that the half strobe length functionality is not used, i.e. HALFWE=0. The leading edge of EBI_WEn can be moved to the right by setting HALFWE=1. This decreases the length of t_{WIDTH_WEn} and increases the length of t_{OSU_WEn} by 1/2 * t_{HFCLKNODIV}.



Figure 4.3. EBI Write Enable Output Timing Diagram

EBI Address Latch Enable Output Timing

Timing applies to multiplexed addressing modes D8A24ALE and D16A16ALE for both polarities. All numbers are based on route locations 0,1,2 only (with all EBI alternate functions using the same location at the same time). Timing is specified at 10% and 90% of IOVDD, 25 pF external loading, and slew rate for all GPIO set to 6.

Table 4.37. EBI Address Latch Enable Output Timing

Parameter	Symbol	Test Condition	Min	Typ	Max	Unit
Output hold time, from trailing EBI_ALE edge to EBI_AD invalid ^{1 2}	t_{OH_ALEn}	IOVDD \geq 1.62 V	-22 + (ADDR-HOLD * $t_{HFCOR-ECLK}$)	—	—	ns
		IOVDD \geq 3.0 V	-13 + (ADDR-HOLD * $t_{HFCOR-ECLK}$)	—	—	ns
Output setup time, from EBI_AD valid to leading EBI_ALE edge	t_{OSU_ALEn}	IOVDD \geq 1.62 V	-10	—	—	ns
		IOVDD \geq 3.0 V	-9	—	—	ns
EBI_ALEn pulse width ¹	t_{WIDTH_ALEn}	IOVDD \geq 1.62 V	-5 + ((ADDR-SETUP + 1) * $t_{HFCOR-ECLK}$)	—	—	ns
		IOVDD \geq 3.0 V	-4 + ((ADDR-SETUP + 1) * $t_{HFCOR-ECLK}$)	—	—	ns

Note:

1. The figure shows the timing for the case that the half strobe length functionality is not used, i.e. HALFALE=0. The trailing edge of EBI_ALEn can be moved to the left by setting HALFALE=1. This decreases the length of t_{WIDTH_ALEn} and increases the length of t_{OSU_ALEn} by $t_{HFCORECLK} - 1/2 * t_{HFCLKNODIV}$.
2. The figure shows a write operation. For a multiplexed read operation the address hold time is controlled via the RDSETUP state instead of via the ADDRHOLD state.



Figure 4.4. EBI Address Latch Enable Output Timing Diagram

EBI Read Enable Output Timing

Timing applies to both EBI_REn and EBI_NANDREn for all addressing modes and both polarities. Output timing for EBI_AD applies only to multiplexed addressing modes D8A24ALE and D16A16ALE. All numbers are based on route locations 0,1,2 only (with all EBI alternate functions using the same location at the same time). Timing is specified at 10% and 90% of IOVDD, 25 pF external loading, and slew rate for all GPIO set to 6.

Table 4.38. EBI Read Enable Output Timing

Parameter	Symbol	Test Condition	Min	Typ	Max	Unit
Output hold time, from trailing EBI_REn / EBI_NANDREn edge to EBI_AD, EBI_A, EBI_CS _n , EBI_BLn invalid	t _{OH_REn}	IOVDD ≥ 1.62 V	-21 + (RDHOLD * t _{HFCOR-ECLK})	—	—	ns
		IOVDD ≥ 3.0 V	-11 + (RDHOLD * t _{HFCOR-ECLK})	—	—	ns
Output setup time, from EBI_AD, EBI_A, EBI_CS _n , EBI_BLn valid to leading EBI_REn / EBI_NANDREn edge ¹	t _{OSU_REn}	IOVDD ≥ 1.62 V	-11 + (RDSETUP * t _{HFCOR-ECLK})	—	—	ns
		IOVDD ≥ 3.0 V	-10 + (RDSETUP * t _{HFCOR-ECLK})	—	—	ns
EBI_REn pulse width ^{1 2}	t _{WIDTH_REn}	IOVDD ≥ 1.62 V	-6 + (MAX(1, RDSTRB) * t _{HFCOR-ECLK})	—	—	ns
		IOVDD ≥ 3.0 V	-4 + (MAX(1, RDSTRB) * t _{HFCOR-ECLK})	—	—	ns

Note:

- The figure shows the timing for the case that the half strobe length functionality is not used, i.e. HALFRE=0. The leading edge of EBI_REn can be moved to the right by setting HALFRE=1. This decreases the length of t_{WIDTH_REn} and increases the length of t_{OSU_REn} by 1/2 * t_{HFCLKNODIV}.
- When page mode is used, RDSTRB is replaced by RDPA for page hits.



Figure 4.5. EBI Read Enable Output Timing Diagram

EBI TFT Output Timing

All numbers are based on route locations 0,1,2 only (with all EBI alternate functions using the same location at the same time). Timing is specified at 10% and 90% of IOVDD, 25 pF external loading, and slew rate for all GPIO set to 6.

Table 4.39. EBI TFT Output Timing

Parameter	Symbol	Test Condition	Min	Typ	Max	Unit
Output hold time, EBI_DCLK to EBI_AD invalid	t _{OH_DCLK}	IOVDD ≥ 1.62 V	-19 + (TFTHOLD * t _{HFCOR-ECLK})	—	—	ns
		IOVDD ≥ 3.0 V	-10 + (TFTHOLD * t _{HFCOR-ECLK})	—	—	ns
Output setup time, EBI_AD valid to EBI_DCLK	t _{OSU_DCLK}	IOVDD ≥ 1.62 V	-12 + (TFTSET-UP * t _{HFCOR-ECLK})	—	—	ns
		IOVDD ≥ 3.0 V	-11 + (TFTSET-UP * t _{HFCOR-ECLK})	—	—	ns



Figure 4.6. EBI TFT Output Timing

EBI Read Enable Timing Requirements

Timing applies to both EBI_REn and EBI_NANDREn for all addressing modes and both polarities. All numbers are based on route locations 0,1,2 only (with all EBI alternate functions using the same location at the same time). Timing is specified at 10% and 90% of IOVDD, 25 pF external loading, and slew rate for all GPIO set to 6.

Table 4.40. EBI Read Enable Timing Requirements

Parameter	Symbol	Test Condition	Min	Typ	Max	Unit
Setup time, from EBI_AD valid to trailing EBI_REn edge	t_{SU_REn}	IOVDD \geq 1.62 V	50	—	—	ns
		IOVDD \geq 3.0 V	29	—	—	ns
Hold time, from trailing EBI_REn edge to EBI_AD invalid	t_{H_REn}	IOVDD \geq 1.62 V	-9	—	—	ns



Figure 4.7. EBI Read Enable Timing Requirements

EBI Ready/Wait Timing Requirements

Timing applies to both EBI_REn and EBI_WEn for all addressing modes and both polarities. All numbers are based on route locations 0,1,2 only (with all EBI alternate functions using the same location at the same time). Timing is specified at 10% and 90% of IOVDD, 25 pF external loading, and slew rate for all GPIO set to 6.

Table 4.41. EBI Ready/Wait Timing Requirements

Parameter	Symbol	Test Condition	Min	Typ	Max	Unit
Setup time, from EBI_ARDY valid to trailing EBI_REn, EBI_WEn edge	t _{SU_ARDY}	IOVDD ≥ 1.62 V	52 + (3 * t _{HFCOR-ECLK})	—	—	ns
		IOVDD ≥ 3.0 V	33 + (3 * t _{HFCOR-ECLK})	—	—	ns
Hold time, from trailing EBI_REn, EBI_WEn edge to EBI_ARDY invalid	t _{H_ARDY}	IOVDD ≥ 1.62 V	-9	—	—	ns



Figure 4.8. EBI Ready/Wait Timing Requirements

4.1.26 Serial Data I/O Host Controller (SDIO)

SDIO DS Mode Timing

Timing is specified for route location 0 at 3.0 V IOVDD with voltage scaling disabled. Slew rate for SD_CLK set to 6, all other GPIO set to 6, DRIVESTRENGTH = STRONG for all pins. SDIO_CTRL_TXDLYMUXSEL = 1. Loading between 5 and 10 pF on all pins or between 10 and 40 pF on all pins.

Table 4.42. SDIO DS Mode Timing (Location 0)

Parameter	Symbol	Test Condition	Min	Typ	Max	Unit
Clock frequency during data transfer	F _{SD_CLK}	Using HFRCO, AUXHFRCO, or USHFRCO	—	—	25	MHz
		Using HF XO	—	—	21	MHz
Clock low time	t _{WL}	Using HFRCO, AUXHFRCO, or USHFRCO	18.3	—	—	ns
		Using HF XO	18.14	—	—	ns
Clock high time	t _{WH}	Using HFRCO, AUXHFRCO, or USHFRCO	18.3	—	—	ns
		Using HF XO	18.14	—	—	ns
Clock rise time	t _R		1.49	—	4.86	ns
Clock fall time	t _F		1.28	—	3.91	ns
Input setup time, CMD, DAT[0:3] valid to SD_CLK	t _{ISU}		5	—	—	ns
Input hold time, SD_CLK to CMD, DAT[0:3] change	t _{IH}		0	—	—	ns
Output delay time, SD_CLK to CMD, DAT[0:3] valid	t _{ODLY}		—	—	14	ns
Output hold time, SD_CLK to CMD, DAT[0:3] change	t _{OH}		5	—	—	ns

Table 4.43. SDIO DS Mode Timing (Location 1)

Parameter	Symbol	Test Condition	Min	Typ	Max	Unit
Clock frequency during data transfer	F _{SD_CLK}	Using HFRCO, AUXHFRCO, or USHFRCO	—	—	19	MHz
		Using HF XO	—	—	15	MHz
Clock low time	t _{WL}	Using HFRCO, AUXHFRCO, or USHFRCO	24.1	—	—	ns
		Using HF XO	23.8	—	—	ns
Clock high time	t _{WH}	Using HFRCO, AUXHFRCO, or USHFRCO	24.1	—	—	ns
		Using HF XO	23.8	—	—	ns
Clock rise time	t _R		1.49	—	4.86	ns
Clock fall time	t _F		1.28	—	3.91	ns

Parameter	Symbol	Test Condition	Min	Typ	Max	Unit
Input setup time, CMD, DAT[0:3] valid to SD_CLK	t_{ISU}		5	—	—	ns
Input hold time, SD_CLK to CMD, DAT[0:3] change	t_{IH}		0	—	—	ns
Output delay time, SD_CLK to CMD, DAT[0:3] valid	t_{ODLY}		—	—	19.1	ns
Output hold time, SD_CLK to CMD, DAT[0:3] change	t_{OH}		5	—	—	ns



Input Timing

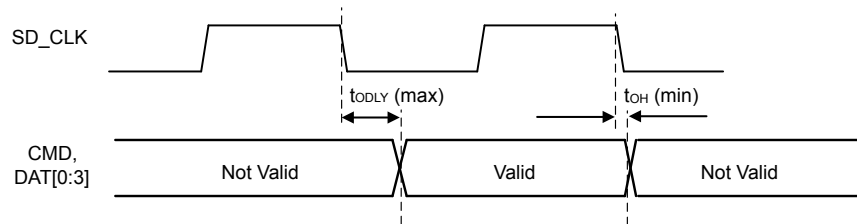

Output Timing

Figure 4.9. SDIO DS Mode Timing

SDIO HS Mode Timing

Timing is specified for route location 0 at 3.0 V IOVDD with voltage scaling disabled. Slew rate for SD_CLK set to 7, all other GPIO set to 6, DRIVESTRENGTH = STRONG for all pins. SDIO_CTRL_TXDLYMUXSEL = 0. Loading between 5 and 10 pF on all pins or between 10 and 20 pF on all pins.

Table 4.44. SDIO HS Mode Timing (Location 0)

Parameter	Symbol	Test Condition	Min	Typ	Max	Unit
Clock frequency during data transfer	F _{SD_CLK}	Using HFRCO, AUXHFRCO, or USHFRCO	—	—	45	MHz
		Using HFXO	—	—	45	MHz
Clock low time	t _{WL}	Using HFRCO, AUXHFRCO, or USHFRCO	10.57	—	—	ns
		Using HFXO	8.66	—	—	ns
Clock high time	t _{WH}	Using HFRCO, AUXHFRCO, or USHFRCO	10.57	—	—	ns
		Using HFXO	8.66	—	—	ns
Clock rise time	t _R		0.83	—	3	ns
Input setup time, CMD, DAT[0:3] valid to SD_CLK	t _{ISU}		3.2	—	—	ns
Input hold time, SD_CLK to CMD, DAT[0:3] change	t _{IH}		2.5	—	—	ns
Output delay time, SD_CLK to CMD, DAT[0:3] valid	t _{ODLY}		—	—	15.3	ns
Output hold time, SD_CLK to CMD, DAT[0:3] change	t _{OH}		2	—	—	ns

Table 4.45. SDIO HS Mode Timing (Location 1)

Parameter	Symbol	Test Condition	Min	Typ	Max	Unit
Clock frequency during data transfer	F _{SD_CLK}	Using HFRCO, AUXHFRCO, or USHFRCO	—	—	35	MHz
		Using HFXO	—	—	35	MHz
Clock low time	t _{WL}	Using HFRCO, AUXHFRCO, or USHFRCO	13.11	—	—	ns
		Using HFXO	10.88	—	—	ns
Clock high time	t _{WH}	Using HFRCO, AUXHFRCO, or USHFRCO	13.11	—	—	ns
		Using HFXO	10.88	—	—	ns
Clock rise time	t _R		0.83	—	3	ns
Input setup time, CMD, DAT[0:3] valid to SD_CLK	t _{ISU}		3.5	—	—	ns
Input hold time, SD_CLK to CMD, DAT[0:3] change	t _{IH}		2.5	—	—	ns

Parameter	Symbol	Test Condition	Min	Typ	Max	Unit
Output delay time, SD_CLK to CMD, DAT[0:3] valid	t_{ODLY}		—	—	20.3	ns
Output hold time, SD_CLK to CMD, DAT[0:3] change	t_{OH}		2	—	—	ns



Input Timing



Output Timing

Figure 4.10. SDIO HS Mode Timing

SDIO SDR Mode Timing

Timing is specified for route location 0 at 1.8 V IOVDD with voltage scaling disabled. Slew rate for SD_CLK set to 7, all other GPIO set to 6, DRIVESTRENGTH = STRONG for all pins. SDIO_CTRL_TXDLYMUXSEL = 0. Loading between 5 and 10 pF on all pins or between 10 and 40 pF on all pins.

Table 4.46. SDIO SDR Mode Timing (Location 0)

Parameter	Symbol	Test Condition	Min	Typ	Max	Unit
Clock frequency during data transfer	F _{SD_CLK}	Using HFRCO, AUXHFRCO, or USHFRCO	—	—	28	MHz
		Using HFXO	—	—	28	MHz
Clock low time	t _{WL}	Using HFRCO, AUXHFRCO, or USHFRCO	16.4	—	—	ns
		Using HFXO	13.61	—	—	ns
Clock high time	t _{WH}	Using HFRCO, AUXHFRCO, or USHFRCO	16.4	—	—	ns
		Using HFXO	13.61	—	—	ns
Clock rise time	t _R		1.8	—	6.56	ns
Input setup time, CMD, DAT[0:3] valid to SD_CLK	t _{ISU}		5	—	—	ns
Input hold time, SD_CLK to CMD, DAT[0:3] change	t _{IH}		1.5	—	—	ns
Output delay time, SD_CLK to CMD, DAT[0:3] valid	t _{ODLY}		—	—	20	ns
Output hold time, SD_CLK to CMD, DAT[0:3] change	t _{OH}		0.8	—	—	ns

Table 4.47. SDIO SDR Mode Timing (Location 1)

Parameter	Symbol	Test Condition	Min	Typ	Max	Unit
Clock frequency during data transfer	F _{SD_CLK}	Using HFRCO, AUXHFRCO, or USHFRCO	—	—	25	MHz
		Using HFXO	—	—	25	MHz
Clock low time	t _{WL}	Using HFRCO, AUXHFRCO, or USHFRCO	18.36	—	—	ns
		Using HFXO	15.24	—	—	ns
Clock high time	t _{WH}	Using HFRCO, AUXHFRCO, or USHFRCO	18.36	—	—	ns
		Using HFXO	15.24	—	—	ns
Clock rise time	t _R		1.8	—	6.56	ns
Input setup time, CMD, DAT[0:3] valid to SD_CLK	t _{ISU}		5	—	—	ns
Input hold time, SD_CLK to CMD, DAT[0:3] change	t _{IH}		1.5	—	—	ns

Parameter	Symbol	Test Condition	Min	Typ	Max	Unit
Output delay time, SD_CLK to CMD, DAT[0:3] valid	t_{ODLY}		—	—	24.3	ns
Output hold time, SD_CLK to CMD, DAT[0:3] change	t_{OH}		0.8	—	—	ns



Input Timing

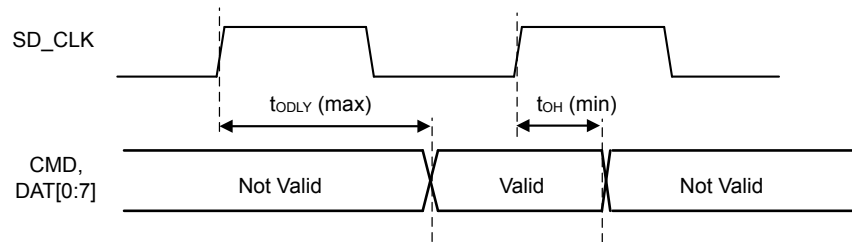

Output Timing

Figure 4.11. SDIO SDR Mode Timing

SDIO DDR Mode Timing

Timing is specified for route location 0 at 1.8 V IOVDD with voltage scaling disabled. Slew rate for SD_CLK set to 6, all other GPIO set to 6, DRIVESTRENGTH = STRONG for all pins. SDIO_CTRL_TXDLYMUXSEL = 1. Loading between 5 and 10 pF on all pins or between 10 and 30 pF on all pins.

Table 4.48. SDIO DDR Mode Timing (Location 0)

Parameter	Symbol	Test Condition	Min	Typ	Max	Unit
Clock frequency during data transfer	F _{SD_CLK}	Using HFRCO, AUXHFRCO, or USHFRCO	—	—	14	MHz
		Using HFXO	—	—	11.5	MHz
Clock low time	t _{WL}	Using HFRCO, AUXHFRCO, or USHFRCO	34.5	—	—	ns
		Using HFXO	34.7	—	—	ns
Clock high time	t _{WH}	Using HFRCO, AUXHFRCO, or USHFRCO	34.5	—	—	ns
		Using HFXO	34.7	—	—	ns
Clock rise time	t _R		1.79	—	6.56	ns
Clock fall time	t _F		1.40	—	5.12	ns
Input setup time, CMD valid to SD_CLK	t _{ISU}		6	—	—	ns
Input hold time, SD_CLK to CMD change	t _{IH}		1.5	—	—	ns
Output delay time, SD_CLK to CMD valid	t _{ODLY}		—	—	21.1	ns
Output hold time, SD_CLK to CMD change	t _{OH}		2	—	—	ns
Input setup time, DAT[0:3] valid to SD_CLK	t _{ISU2X}		6.3	—	—	ns
Input hold time, SD_CLK to DAT[0:3] change	t _{IH2X}		1.5	—	—	ns
Output delay time, SD_CLK to DAT[0:3] valid	t _{ODLY2X}		—	—	30.8	ns
Output hold time, SD_CLK to DAT[0:3] change	t _{OH2X}		2	—	—	ns

Table 4.49. SDIO DDR Mode Timing (Location 1)

Parameter	Symbol	Test Condition	Min	Typ	Max	Unit
Clock frequency during data transfer	F _{SD_CLK}	Using HFRCO, AUXHFRCO, or USHFRCO	—	—	12.5	MHz
		Using HFXO	—	—	10	MHz
Clock low time	t _{WL}	Using HFRCO, AUXHFRCO, or USHFRCO	36.72	—	—	ns
		Using HFXO	38.1	—	—	ns

Parameter	Symbol	Test Condition	Min	Typ	Max	Unit
Clock high time	t_{WH}	Using HFRCO, AUXHFRCO, or USHFRCO	36.72	—	—	ns
		Using HFXO	38.1	—	—	ns
Clock rise time	t_R		1.79	—	6.56	ns
Clock fall time	t_F		1.40	—	5.12	ns
Input setup time, CMD valid to SD_CLK	t_{ISU}		7	—	—	ns
Input hold time, SD_CLK to CMD change	t_{IH}		1.5	—	—	ns
Output delay time, SD_CLK to CMD valid	t_{ODLY}		—	—	24.81	ns
Output hold time, SD_CLK to CMD change	t_{OH}		2	—	—	ns
Input setup time, DAT[0:3] valid to SD_CLK	t_{ISU2X}		8.3	—	—	ns
Input hold time, SD_CLK to DAT[0:3] change	t_{IH2X}		1.5	—	—	ns
Output delay time, SD_CLK to DAT[0:3] valid	t_{ODLY2X}		—	—	35.1	ns
Output hold time, SD_CLK to DAT[0:3] change	t_{OH2X}		2	—	—	ns



Input Timing



Output Timing

Figure 4.12. SDIO DDR Mode Timing

SDIO MMC Legacy Mode Timing

Timing is specified with voltage scaling disabled. Slew rate for SD_CLK set to 7, all other GPIO set to 6, DRIVESTRENGTH = STRONG for all pins. SDIO_CTRL_TXDLYMUXSEL = 1. Loading between 5 and 10 pF on all pins or between 10 and 20 pF on all pins.

Table 4.50. SDIO MMC Legacy Mode Timing (Location 0)

Parameter	Symbol	Test Condition	Min	Typ	Max	Unit
Clock frequency during data transfer	F _{SD_CLK}	Using HFRCO, AUXHFRCO, or USHFRCO	—	—	28	MHz
		Using HFXO	—	—	28	MHz
Clock low time	t _{WL}	Using HFRCO, AUXHFRCO, or USHFRCO	16.96	—	—	ns
		Using HFXO	14.28	—	—	ns
Clock high time	t _{WH}	Using HFRCO, AUXHFRCO, or USHFRCO	16.96	—	—	ns
		Using HFXO	14.28	—	—	ns
Clock rise time	t _R		1.8	—	5.6	ns
Input setup time, CMD, DAT[0:7] valid to SD_CLK	t _{ISU}		4.8	—	—	ns
Input hold time, SD_CLK to CMD, DAT[0:7] change	t _{IH}		2.5	—	—	ns
Output delay time, SD_CLK to CMD, DAT[0:7] valid	t _{ODLY}		—	—	18.8	ns
Output hold time, SD_CLK to CMD, DAT[0:7] change	t _{OH}		3	—	—	ns

Table 4.51. SDIO MMC Legacy Mode Timing (Location 1)

Parameter	Symbol	Test Condition	Min	Typ	Max	Unit
Clock frequency during data transfer	F _{SD_CLK}	Using HFRCO, AUXHFRCO, or USHFRCO	—	—	25	MHz
		Using HFXO	—	—	25	MHz
Clock low time	t _{WL}	Using HFRCO, AUXHFRCO, or USHFRCO	18.3	—	—	ns
		Using HFXO	15.2	—	—	ns
Clock high time	t _{WH}	Using HFRCO, AUXHFRCO, or USHFRCO	18.3	—	—	ns
		Using HFXO	15.2	—	—	ns
Clock rise time	t _R		1.8	—	5.6	ns
Input setup time, CMD, DAT[0:7] valid to SD_CLK	t _{ISU}		4.8	—	—	ns
Input hold time, SD_CLK to CMD, DAT[0:7] change	t _{IH}		2.5	—	—	ns
Output delay time, SD_CLK to CMD, DAT[0:7] valid	t _{ODLY}		—	—	23.6	ns

Parameter	Symbol	Test Condition	Min	Typ	Max	Unit
Output hold time, SD_CLK to CMD, DAT[0:7] change	t_{OH}		3	—	—	ns



Figure 4.13. SDIO MMC Legacy Mode Timing

SDIO MMC SDR Mode Timing at 1.8 V

Timing is specified for route location 0 at 1.8 V IOVDD with voltage scaling disabled. Slew rate for SD_CLK set to 7, all other GPIO set to 6, DRIVESTRENGTH = STRONG for all pins. SDIO_CTRL_TXDLYMUXSEL = 1. Loading between 5 and 10 pF on all pins or between 10 and 20 pF on all pins.

Table 4.52. SDIO MMC SDR Mode Timing (Location 0, 1.8V I/O)

Parameter	Symbol	Test Condition	Min	Typ	Max	Unit
Clock frequency during data transfer	F _{SD_CLK}	Using HFRCO, AUXHFRCO, or USHFRCO	—	—	28	MHz
		Using HFXO	—	—	28	MHz
Clock low time	t _{WL}	Using HFRCO, AUXHFRCO, or USHFRCO	16.96	—	—	ns
		Using HFXO	14.28	—	—	ns
Clock high time	t _{WH}	Using HFRCO, AUXHFRCO, or USHFRCO	16.96	—	—	ns
		Using HFXO	14.28	—	—	ns
Clock rise time	t _R		1.8	—	5.6	ns
Input setup time, CMD, DAT[0:7] valid to SD_CLK	t _{ISU}		4.8	—	—	ns
Input hold time, SD_CLK to CMD, DAT[0:7] change	t _{IH}		2.5	—	—	ns
Output delay time, SD_CLK to CMD, DAT[0:7] valid	t _{ODLY}		—	—	18.8	ns
Output hold time, SD_CLK to CMD, DAT[0:7] change	t _{OH}		2.85	—	—	ns

Table 4.53. SDIO MMC SDR Mode Timing (Location 1, 1.8V I/O)

Parameter	Symbol	Test Condition	Min	Typ	Max	Unit
Clock frequency during data transfer	F _{SD_CLK}	Using HFRCO, AUXHFRCO, or USHFRCO	—	—	25	MHz
		Using HFXO	—	—	25	MHz
Clock low time	t _{WL}	Using HFRCO, AUXHFRCO, or USHFRCO	18.3	—	—	ns
		Using HFXO	15.2	—	—	ns
Clock high time	t _{WH}	Using HFRCO, AUXHFRCO, or USHFRCO	18.3	—	—	ns
		Using HFXO	15.2	—	—	ns
Clock rise time	t _R		1.8	—	5.6	ns
Input setup time, CMD, DAT[0:7] valid to SD_CLK	t _{ISU}		4.8	—	—	ns
Input hold time, SD_CLK to CMD, DAT[0:7] change	t _{IH}		2.5	—	—	ns

Parameter	Symbol	Test Condition	Min	Typ	Max	Unit
Output delay time, SD_CLK to CMD, DAT[0:7] valid	t_{ODLY}		—	—	23.6	ns
Output hold time, SD_CLK to CMD, DAT[0:7] change	t_{OH}		3	—	—	ns



Input Timing



Output Timing

Figure 4.14. SDIO MMC SDR Mode Timing

SDIO MMC SDR Mode Timing at 3.0 V

Timing is specified for route location 0 at 3.0 V IOVDD with voltage scaling disabled. Slew rate for SD_CLK set to 7, all other GPIO set to 6, DRIVESTRENGTH = STRONG for all pins. SDIO_CTRL_TXDLYMUXSEL = 1. Loading between 5 and 10 pF on all pins or between 10 and 20 pF on all pins.

Table 4.54. SDIO MMC SDR Mode Timing (Location 0, 3V I/O)

Parameter	Symbol	Test Condition	Min	Typ	Max	Unit
Clock frequency during data transfer	F _{SD_CLK}	Using HFRCO, AUXHFRCO, or USHFRCO	—	—	49	MHz
		Using HFXO	—	—	49	MHz
Clock low time	t _{WL}	Using HFRCO, AUXHFRCO, or USHFRCO	9.7	—	—	ns
		Using HFXO	7.8	—	—	ns
Clock high time	t _{WH}	Using HFRCO, AUXHFRCO, or USHFRCO	9.7	—	—	ns
		Using HFXO	7.8	—	—	ns
Clock rise time	t _R		0.85	—	2.5	ns
Input setup time, CMD, DAT[0:7] valid to SD_CLK	t _{ISU}		3.13	—	—	ns
Input hold time, SD_CLK to CMD, DAT[0:7] change	t _{IH}		2.5	—	—	ns
Output delay time, SD_CLK to CMD, DAT[0:7] valid	t _{ODLY}		—	—	15.2	ns
Output hold time, SD_CLK to CMD, DAT[0:7] change	t _{OH}		3	—	—	ns

Table 4.55. SDIO MMC SDR Mode Timing (Location 1, 3V I/O)

Parameter	Symbol	Test Condition	Min	Typ	Max	Unit
Clock frequency during data transfer	F _{SD_CLK}	Using HFRCO, AUXHFRCO, or USHFRCO	—	—	38	MHz
		Using HFXO	—	—	38	MHz
Clock low time	t _{WL}	Using HFRCO, AUXHFRCO, or USHFRCO	12	—	—	ns
		Using HFXO	10	—	—	ns
Clock high time	t _{WH}	Using HFRCO, AUXHFRCO, or USHFRCO	12	—	—	ns
		Using HFXO	10	—	—	ns
Clock rise time	t _R		0.85	—	2.5	ns
Input setup time, CMD, DAT[0:7] valid to SD_CLK	t _{ISU}		3.4	—	—	ns
Input hold time, SD_CLK to CMD, DAT[0:7] change	t _{IH}		2.5	—	—	ns

Parameter	Symbol	Test Condition	Min	Typ	Max	Unit
Output delay time, SD_CLK to CMD, DAT[0:7] valid	t_{ODLY}		—	—	19.83	ns
Output hold time, SD_CLK to CMD, DAT[0:7] change	t_{OH}		3	—	—	ns



Input Timing



Output Timing

Figure 4.15. SDIO MMC SDR Mode Timing

SDIO MMC DDR Mode Timing at 1.8 V

Timing is specified for route location 0 at 1.8 V IOVDD with voltage scaling disabled. Slew rate for SD_CLK set to 7, all other GPIO set to 6, DRIVESTRENGTH = STRONG for all pins. SDIO_CTRL_TXDLYMUXSEL = 1. Loading between 5 and 10 pF on all pins or between 10 and 25 pF on all pins.

Table 4.56. SDIO MMC DDR Mode Timing (Location 0, 1.8V I/O)

Parameter	Symbol	Test Condition	Min	Typ	Max	Unit
Clock frequency during data transfer	F _{SD_CLK}	Using HFRCO, AUXHFRCO, or USHFRCO	—	—	14.5	MHz
		Using HFXO	—	—	12	MHz
Clock low time	t _{WL}	Using HFRCO, AUXHFRCO, or USHFRCO	31.6	—	—	ns
		Using HFXO	31.2	—	—	ns
Clock high time	t _{WH}	Using HFRCO, AUXHFRCO, or USHFRCO	31.6	—	—	ns
		Using HFXO	31.2	—	—	ns
Clock rise time	t _R		1.79	—	5.54	ns
Clock fall time	t _F		1.40	—	4.21	ns
Input setup time, CMD valid to SD_CLK	t _{ISU}		5.7	—	—	ns
Input hold time, SD_CLK to CMD change	t _{IH}		2.5	—	—	ns
Output delay time, SD_CLK to CMD valid	t _{ODLY}		—	—	19.81	ns
Output hold time, SD_CLK to CMD change	t _{OH}		3	—	—	ns
Input setup time, DAT[0:7] valid to SD_CLK	t _{ISU2X}		7.6	—	—	ns
Input hold time, SD_CLK to DAT[0:7] change	t _{IH2X}		2.5	—	—	ns
Output delay time, SD_CLK to DAT[0:7] valid	t _{ODLY2X}		—	—	30.3	ns
Output hold time, SD_CLK to DAT[0:7] change	t _{OH2X}		3	—	—	ns

Table 4.57. SDIO MMC DDR Mode Timing (Location 1, 1.8V I/O)

Parameter	Symbol	Test Condition	Min	Typ	Max	Unit
Clock frequency during data transfer	F _{SD_CLK}	Using HFRCO, AUXHFRCO, or USHFRCO	—	—	12	MHz
		Using HFXO	—	—	10	MHz
Clock low time	t _{WL}	Using HFRCO, AUXHFRCO, or USHFRCO	38.2	—	—	ns
		Using HFXO	38	—	—	ns

Parameter	Symbol	Test Condition	Min	Typ	Max	Unit
Clock high time	t_{WH}	Using HFRCO, AUXHFRCO, or USHFRCO	38.2	—	—	ns
		Using HFXO	38	—	—	ns
Clock rise time	t_R		1.79	—	5.54	ns
Clock fall time	t_F		1.40	—	4.21	ns
Input setup time, CMD valid to SD_CLK	t_{ISU}		7.1	—	—	ns
Input hold time, SD_CLK to CMD change	t_{IH}		2.5	—	—	ns
Output delay time, SD_CLK to CMD valid	t_{ODLY}		—	—	23.87	ns
Output hold time, SD_CLK to CMD change	t_{OH}		3	—	—	ns
Input setup time, DAT[0:7] valid to SD_CLK	t_{ISU2X}		8.24	—	—	ns
Input hold time, SD_CLK to DAT[0:7] change	t_{IH2X}		2.5	—	—	ns
Output delay time, SD_CLK to DAT[0:7] valid	t_{ODLY2X}		—	—	34.94	ns
Output hold time, SD_CLK to DAT[0:7] change	t_{OH2X}		3	—	—	ns



Input Timing



Output Timing

Figure 4.16. SDIO MMC DDR Mode Timing

SDIO MMC DDR Mode Timing at 3.0 V

Timing is specified for route location 0 at 3.0 V IOVDD with voltage scaling disabled. Slew rate for SD_CLK set to 7, all other GPIO set to 6, DRIVESTRENGTH = STRONG for all pins. SDIO_CTRL_TXDLYMUXSEL = 1. Loading between 5 and 10 pF on all pins or between 10 and 25 pF on all pins.

Table 4.58. SDIO MMC DDR Mode Timing (Location 0, 3V I/O)

Parameter	Symbol	Test Condition	Min	Typ	Max	Unit
Clock frequency during data transfer	F _{SD_CLK}	Using HFRCO, AUXHFRCO, or USHFRCO	—	—	16	MHz
		Using HFXO	—	—	13.5	MHz
Clock low time	t _{WL}	Using HFRCO, AUXHFRCO, or USHFRCO	29.69	—	—	ns
		Using HFXO	29.63	—	—	ns
Clock high time	t _{WH}	Using HFRCO, AUXHFRCO, or USHFRCO	29.69	—	—	ns
		Using HFXO	29.63	—	—	ns
Clock rise time	t _R		0.84	—	2.5	ns
Clock fall time	t _F		0.77	—	2.2	ns
Input setup time, CMD valid to SD_CLK	t _{ISU}		4.3	—	—	ns
Input hold time, SD_CLK to CMD change	t _{IH}		2.5	—	—	ns
Output delay time, SD_CLK to CMD valid	t _{ODLY}		—	—	16.47	ns
Output hold time, SD_CLK to CMD change	t _{OH}		3	—	—	ns
Input setup time, DAT[0:7] valid to SD_CLK	t _{ISU2X}		6	—	—	ns
Input hold time, SD_CLK to DAT[0:7] change	t _{IH2X}		2.5	—	—	ns
Output delay time, SD_CLK to DAT[0:7] valid	t _{ODLY2X}		—	—	26.6	ns
Output hold time, SD_CLK to DAT[0:7] change	t _{OH2X}		3	—	—	ns

Table 4.59. SDIO MMC DDR Mode Timing (Location 1, 3V I/O)

Parameter	Symbol	Test Condition	Min	Typ	Max	Unit
Clock frequency during data transfer	F _{SD_CLK}	Using HFRCO, AUXHFRCO, or USHFRCO	—	—	12.5	MHz
		Using HFXO	—	—	11	MHz
Clock low time	t _{WL}	Using HFRCO, AUXHFRCO, or USHFRCO	36.7	—	—	ns
		Using HFXO	34.6	—	—	ns

Parameter	Symbol	Test Condition	Min	Typ	Max	Unit
Clock high time	t_{WH}	Using HFRCO, AUXHFRCO, or USHFRCO	36.7	—	—	ns
		Using HFXO	34.6	—	—	ns
Clock rise time	t_R		0.84	—	2.5	ns
Clock fall time	t_F		0.77	—	2.2	ns
Input setup time, CMD valid to SD_CLK	t_{ISU}		5.1	—	—	ns
Input hold time, SD_CLK to CMD change	t_{IH}		2.5	—	—	ns
Output delay time, SD_CLK to CMD valid	t_{ODLY}		—	—	20.9	ns
Output hold time, SD_CLK to CMD change	t_{OH}		3	—	—	ns
Input setup time, DAT[0:7] valid to SD_CLK	t_{ISU2X}		6.8	—	—	ns
Input hold time, SD_CLK to DAT[0:7] change	t_{IH2X}		2.5	—	—	ns
Output delay time, SD_CLK to DAT[0:7] valid	t_{ODLY2X}		—	—	31.37	ns
Output hold time, SD_CLK to DAT[0:7] change	t_{OH2X}		3	—	—	ns



Input Timing



Output Timing

Figure 4.17. SDIO MMC DDR Mode Timing

SDIO SPI Mode Timing

Timing is specified for route location 0 at 3.0 V IOVDD with voltage scaling disabled. Slew rate for SD_CLK set to 6, all other GPIO set to 6, DRIVESTRENGTH = STRONG for all pins. SDIO_CTRL_TXDLYMUXSEL = 1. Loading between 5 and 10 pF on all pins or between 10 and 40 pF on all pins.

Table 4.60. SDIO SPI Mode Timing (Location 0)

Parameter	Symbol	Test Condition	Min	Typ	Max	Unit
Clock frequency during data transfer	F _{SCLK}	Using HFRCO, AUXHFRCO, or USHFRCO	—	—	25	MHz
		Using HFXO	—	—	21	MHz
Clock low time	t _{WL}	Using HFRCO, AUXHFRCO, or USHFRCO	18.3	—	—	ns
		Using HFXO	18.14	—	—	ns
Clock high time	t _{WH}	Using HFRCO, AUXHFRCO, or USHFRCO	18.3	—	—	ns
		Using HFXO	18.14	—	—	ns
Clock rise time	t _R		1.49	—	4.86	ns
Clock fall time	t _F		1.28	—	3.91	ns
Input setup time, MISO valid to SCLK	t _{ISU}		5	—	—	ns
Input hold time, SCLK to MISO change	t _{IH}		0	—	—	ns
Output delay time, SCLK to MOSI valid	t _{ODLY}		—	—	14	ns
Output hold time, SCLK to MOSI change	t _{OH}		5	—	—	ns

Table 4.61. SDIO SPI Mode Timing (Location 1)

Parameter	Symbol	Test Condition	Min	Typ	Max	Unit
Clock frequency during data transfer	F _{SCLK}	Using HFRCO, AUXHFRCO, or USHFRCO	—	—	19	MHz
		Using HFXO	—	—	15	MHz
Clock low time	t _{WL}	Using HFRCO, AUXHFRCO, or USHFRCO	24.1	—	—	ns
		Using HFXO	23.8	—	—	ns
Clock high time	t _{WH}	Using HFRCO, AUXHFRCO, or USHFRCO	24.1	—	—	ns
		Using HFXO	23.8	—	—	ns
Clock rise time	t _R		1.49	—	4.86	ns
Clock fall time	t _F		1.28	—	3.91	ns
Input setup time, MISO valid to SCLK	t _{ISU}		5	—	—	ns

Parameter	Symbol	Test Condition	Min	Typ	Max	Unit
Input hold time, SCLK to MISO change	t_{IH}		0	—	—	ns
Output delay time, SCLK to MOSI valid	t_{ODLY}		—	—	19.1	ns
Output hold time, SCLK to MOSI change	t_{OH}		5	—	—	ns



Figure 4.18. SDIO SPI Mode Timing

4.1.27 Quad SPI (QSPI)

4.1.27.1 QSPI SDR Mode

QSPI SDR Mode Timing (Location 0)

Timing is specified with voltage scaling disabled, PHY-mode, route location 0 only, TX DLL = 20, RX DLL = 45, 5-25 pF loading per GPIO, and slew rate for all GPIO set to 6, DRIVESTRENGTH = STRONG.

Table 4.62. QSPI SDR Mode Timing (Location 0)

Parameter	Symbol	Test Condition	Min	Typ	Max	Unit
Full SCLK period	T		$(1/F_{SCLK})^*$ 0.965	—	—	ns
Output valid	t_{OV}		—	—	T/2 - 3.0	ns
Output hold	t_{OH}		T/2 - 21.4	—	—	ns
Input setup	t_{SU}		25.96 - T/2	—	—	ns
Input hold	t_{H}		T/2 - 1.0	—	—	ns

QSPI SDR Mode Timing (Optimal Conditions)

Timing is specified at IOVDD ≥ 3.0V, using internal HFRCO oscillator and with voltage scaling disabled, PHY-mode, route location 0 only, TX DLL = 17, RX DLL = 29, 5-25 pF loading per GPIO, and slew rate for all GPIO set to 6, DRIVESTRENGTH = STRONG.

Table 4.63. QSPI SDR Mode Timing (Optimized at 3.0V, Location 0)

Parameter	Symbol	Test Condition	Min	Typ	Max	Unit
Full SCLK period	T		$(1/F_{SCLK})^*$ 0.965	—	—	ns
Output valid	t _{OV}		—	—	T/2 - 2.2	ns
Output hold	t _{OH}		T/2 - 19.13	—	—	ns
Input setup	t _{SU}		15.33 - T/2	—	—	ns
Input hold	t _H		T/2 - 4.1	—	—	ns

QSPI SDR Mode Timing (Locations 1, 2)

Timing is specified with voltage scaling disabled, PHY-mode, route locations other than 0, TX DLL = 15, RX DLL = 47, 5-25 pF loading per GPIO, and slew rate for all GPIO set to 6, DRIVESTRENGTH = STRONG.

Table 4.64. QSPI SDR Mode Timing (Locations 1, 2)

Parameter	Symbol	Test Condition	Min	Typ	Max	Unit
Full SCLK period	T		$(1/F_{SCLK}) * 0.965$	—	—	ns
Output valid	t_{OV}		—	—	T/2 - 2.6	ns
Output hold	t_{OH}		T/2 - 19.26	—	—	ns
Input setup	t_{SU}		25.47 - T/2	—	—	ns
Input hold	t_H		T/2 - 0.5	—	—	ns



Figure 4.19. QSPI SDR Timing Diagrams

QSPI SDR Flash Timing Example

This example uses timing values from SDR Mode Timing (Optimal Conditions) to demonstrate the calculation of allowable flash timing using the QSPI in SDR mode.

- Using a configured SCLK frequency (F_{SCLK}) of 40 MHz:
- The resulting minimum period, $T(\min) = (1/F_{SCLK}) * 0.965 = 24.125$ ns.
- Flash will see a minimum setup time of $T/2 - t_{OV} = T/2 - (T/2 - 2.2) = 2.4$ ns.
- Flash will see a minimum hold time of $T/2 + t_{OH} = T/2 + (T/2 - 19.13) = T - 19.13 = 24.125 - 19.13 = 4.9$ ns.
- Flash can have a maximum output valid time of $T/2 - t_{SU} = T/2 - (15.33 - T/2) = T - 15.33 = 24.125 - 15.33 = 8.8$ ns.
- Flash can have a minimum output hold time of $t_H - T/2 = (T/2 - 4.1) - T/2 = -4.1$ ns.

4.1.27.2 QSPI DDR Mode

QSPI DDR Mode Timing (Location 0)

Timing is specified with voltage scaling disabled, PHY-mode, route location 0 only, TX DLL = 20, RX DLL = 52, 5-25 pF loading per GPIO, and slew rate for all GPIO set to 6, DRIVESTRENGTH = STRONG.

Table 4.65. QSPI DDR Mode Timing (Location 0)

Parameter	Symbol	Test Condition	Min	Typ	Max	Unit
Half SCLK period	T/2	HFXO	(1/F _{SCLK}) * 0.4 - 0.4	—	—	ns
		HFRCO, AUXHFRCO, USHFRCO	(1/F _{SCLK}) * 0.44	—	—	ns
Output valid	t _{OV}		—	—	T/2 - 2.3	ns
Output hold	t _{OH}		T/2 - 18.63	—	—	ns
Input setup	t _{SU}		14.85	—	—	ns
Input hold	t _H		-2.2	—	—	ns

QSPI DDR Mode Timing (Optimal Conditions)

Timing is specified at IOVDD ≥ 3.0V, using internal HFRCO oscillator and with voltage scaling disabled, PHY-mode, route location 0 only, TX DLL = 17, RX DLL = 37, 5-25 pF loading per GPIO, and slew rate for all GPIO set to 6, DRIVESTRENGTH = STRONG.

Table 4.66. QSPI DDR Mode Timing (Optimized at 3.0V, Location 0)

Parameter	Symbol	Test Condition	Min	Typ	Max	Unit
Half SCLK period	T/2	HFRCO, AUXHFRCO, USHFRCO	(1/F _{SCLK}) * 0.44	—	—	ns
Output valid	t _{OV}		—	—	T/2 - 2.4	ns
Output hold	t _{OH}		T/2 - 19.02	—	—	ns
Input setup	t _{SU}		12.93	—	—	ns
Input hold	t _H		-0.8	—	—	ns

QSPI DDR Mode Timing (Locations 1, 2)

Timing is specified with voltage scaling disabled, PHY-mode, route locations other than 0, TX DLL = 17, RX DLL = 50, 5-25 pF loading per GPIO, and slew rate for all GPIO set to 6, DRIVESTRENGTH = STRONG.

Table 4.67. QSPI DDR Mode Timing (Locations 1, 2)

Parameter	Symbol	Test Condition	Min	Typ	Max	Unit
Half SCLK period	T/2	HFXO	$(1/F_{SCLK})^* 0.4 - 0.4$	—	—	ns
		HFRCO, AUXHFRCO, USHFRCO	$(1/F_{SCLK})^* 0.44$	—	—	ns
Output valid	t_{OV}		—	—	T/2 - 2.8	ns
Output hold	t_{OH}		T/2 - 15.21	—	—	ns
Input setup	t_{SU}		9.2	—	—	ns
Input hold	t_H		-0.38	—	—	ns



Figure 4.20. QSPI DDR Timing Diagrams

QSPI DDR Flash Timing Example

This example uses timing values for DDR Mode Timing (Optimal Conditions) to demonstrate the calculation of allowable flash timing using the QSPI in DDR mode.

- Using a configured SCLK frequency (F_{SCLK}) of 20 MHz from the HFXO clock source:
- The resulting minimum half-period, $T/2(\min) = (1/F_{SCLK}) * 0.44 = 22$ ns.
- Flash will see a minimum setup time of $T/2 - t_{OV} = T/2 - (T/2 - 2.2) = 2.4$ ns.
- Flash will see a minimum hold time of $t_{OH} = T/2 - 19.02 = 22 - 19.02 = 2.98$ ns.
- Flash can have a maximum output valid time of $T/2 - t_{SU} = T/2 - 12.93 = 22 - 12.93 = 9.07$ ns.
- Flash can have a minimum output hold time of $t_H = -0.8$ ns.

4.1.28 PDM

PDM Timing

Timing is specified for all route locations, 10 pF to 25 pF loading on PDM_CLK, and slew rate for PDM_CLK set to 7.

Table 4.68. Pulse Density Modulation (PDM) Timing

Parameter	Symbol	Test Condition	Min	Typ	Max	Unit
PDM_CLK frequency during data transfer	$F_{\text{PDM_CLK}}$	Microphone mode, VSCALE2 or VSCALE0	—	—	4.8	MHz
		Sensor mode, VSCALE2	—	—	20	MHz
		Sensor mode, VSCALE0	—	—	10	MHz
PDM_CLK duty cycle	$DC_{\text{PDM_CLK}}$		47.5	—	52.5	%
PDM_CLK rise time	t_{R}		—	—	7.5	ns
PDM_CLK fall time	t_{F}		—	—	7.5	ns
Input setup time	t_{ISU}		20	—	—	ns
Input hold time	t_{IH}	VSCALE2	3	—	—	ns
		VSCALE0	4	—	—	ns



Figure 4.21. PDM Timing Diagrams

4.2 Typical Performance Curves

Typical performance curves indicate typical characterized performance under the stated conditions.

4.2.1 Supply Current



Figure 4.22. EM0 Full Speed Active Mode Typical Supply Current vs. Temperature



Figure 4.23. EM0 Active Mode Typical Supply Current vs. Temperature

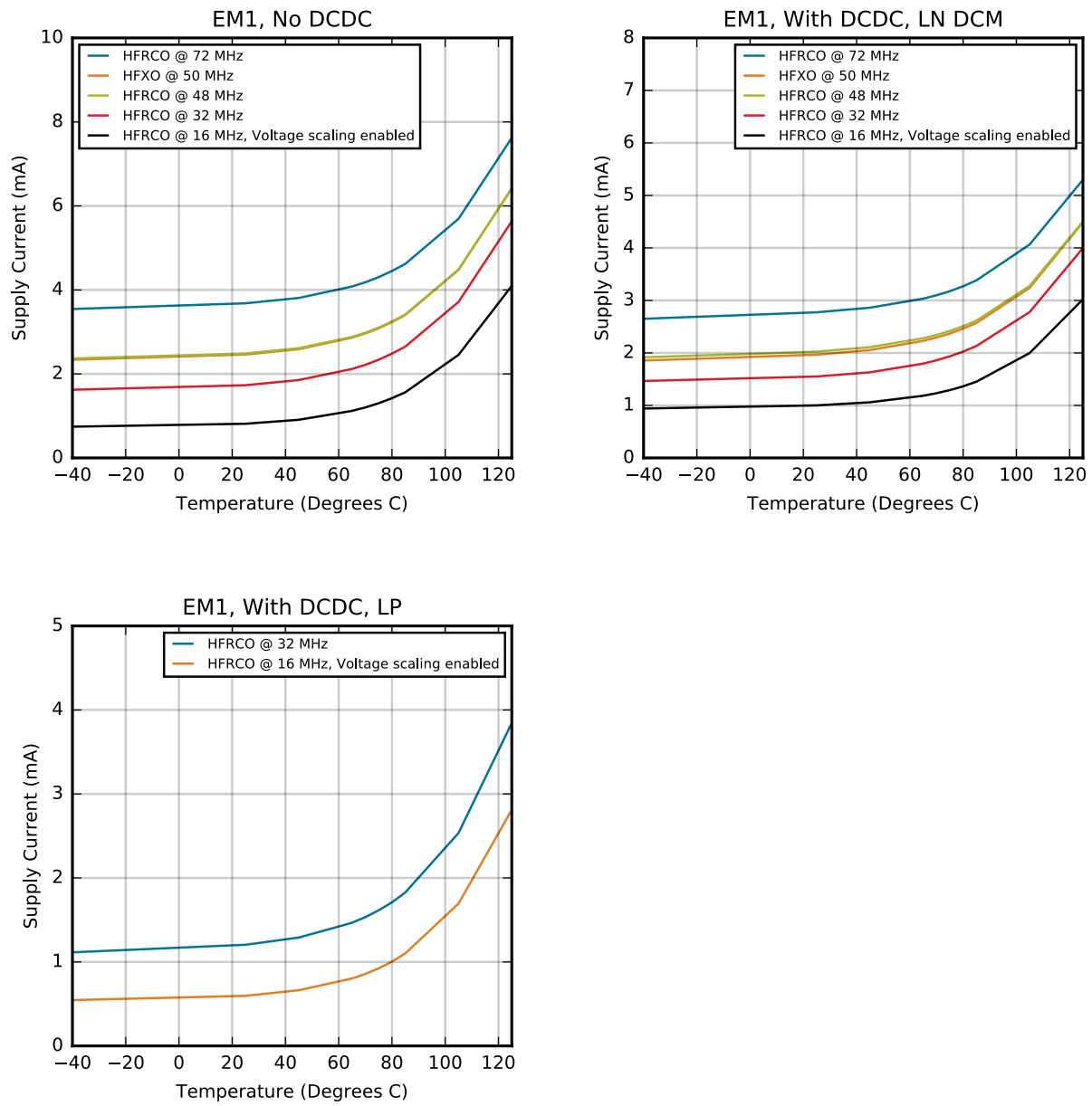

Figure 4.24. EM1 Sleep Mode Typical Supply Current vs. Temperature

Typical supply current for EM2, EM3 and EM4H using standard software libraries from Silicon Laboratories.



Figure 4.25. EM2, EM3, EM4H and EM4S Typical Supply Current vs. Temperature



Figure 4.26. EM0 and EM1 Mode Typical Supply Current vs. Supply

Typical supply current for EM2, EM3 and EM4H using standard software libraries from Silicon Laboratories.



Figure 4.27. EM2, EM3, EM4H and EM4S Typical Supply Current vs. Supply

4.2.2 DC-DC Converter

Default test conditions: CCM mode, LDCDC = 4.7 μ H, CDCDC = 4.7 μ F, VDCDC_I = 3.3 V, VDCDC_O = 1.8 V, FDCDC_LN = 7 MHz



Figure 4.28. DC-DC Converter Typical Performance Characteristics



Figure 4.29. DC-DC Converter Transition Waveforms

5. Pin Definitions

5.1 EFM32GG12B8xx in BGA120 Device Pinout



Figure 5.1. EFM32GG12B8xx in BGA120 Device Pinout

The following table provides package pin connections and general descriptions of pin functionality. For detailed information on the supported features for each GPIO pin, see [5.20 GPIO Functionality Table](#) or [5.21 Alternate Functionality Overview](#).

Table 5.1. EFM32GG12B8xx in BGA120 Device Pinout

Pin Name	Pin(s)	Description	Pin Name	Pin(s)	Description
PE15	A1	GPIO	PE14	A2	GPIO
PE12	A3	GPIO	PE9	A4	GPIO
PD11	A5	GPIO	PD9	A6	GPIO
PF7	A7	GPIO	PF5	A8	GPIO
PF14	A9	GPIO (5V)	PF12	A10	GPIO (5V)

Pin Name	Pin(s)	Description	Pin Name	Pin(s)	Description
VREGI	A11	Input to 5 V regulator.	VREGO	A12	Decoupling for 5 V regulator and regulator output. Power for USB PHY in USB-enabled OPNs
PF11	A13	GPIO (5V)	PA15	B1	GPIO
PE13	B2	GPIO	PE11	B3	GPIO
PE8	B4	GPIO	PD12	B5	GPIO
PD10	B6	GPIO	PF8	B7	GPIO
PF6	B8	GPIO	PF13	B9	GPIO (5V)
PF4	B10	GPIO	PF3	B11	GPIO
VBUS	B12	USB VBUS signal and auxiliary input to 5 V regulator.	PF10	B13	GPIO (5V)
PA1	C1	GPIO	PA0	C2	GPIO
PE10	C3	GPIO	PD13	C4	GPIO (5V)
VSS	C5 C8 H3 J3 K11 L5 L8	Ground	IOVDD1	C6	Digital IO power supply 1.
PF9	C7	GPIO	IOVDD0	C9 G3 J11 K3 L4 L9	Digital IO power supply 0.
PF2	C10	GPIO	PF1	C11	GPIO (5V)
PC14	C12	GPIO (5V)	PC15	C13	GPIO (5V)
PA3	D1	GPIO	PA2	D2	GPIO
PB15	D3	GPIO (5V)	PF0	D11	GPIO (5V)
PC12	D12	GPIO (5V)	PC13	D13	GPIO (5V)
PA6	E1	GPIO	PA5	E2	GPIO
PA4	E3	GPIO	PC9	E11	GPIO (5V)
PC10	E12	GPIO (5V)	PC11	E13	GPIO (5V)
PB0	F1	GPIO	PB1	F2	GPIO
PB2	F3	GPIO	PE6	F11	GPIO
PE7	F12	GPIO	PC8	F13	GPIO (5V)
PB3	G1	GPIO	PB4	G2	GPIO
PE3	G11	GPIO	PE4	G12	GPIO
PE5	G13	GPIO	PB5	H1	GPIO
PB6	H2	GPIO	DVDD	H11	Digital power supply.

Pin Name	Pin(s)	Description	Pin Name	Pin(s)	Description
PE2	H12	GPIO	DECOUPLE	H13	Decouple output for on-chip voltage regulator. An external decoupling capacitor is required at this pin. This pin should not be used to power any external circuits.
PD14	J1	GPIO (5V)	PD15	J2	GPIO (5V)
PE1	J12	GPIO (5V)	VREGVDD	J13	Voltage regulator VDD input
PC0	K1	GPIO (5V)	PC1	K2	GPIO (5V)
PE0	K12	GPIO (5V)	VREGSW	K13	DCDC regulator switching node
PC2	L1	GPIO (5V)	PC3	L2	GPIO (5V)
PA7	L3	GPIO	PB9	L6	GPIO (5V)
PB10	L7	GPIO (5V)	PD1	L10	GPIO
PC6	L11	GPIO	PC7	L12	GPIO
VREGVSS	L13	Voltage regulator VSS	PB7	M1	GPIO
PC4	M2	GPIO	PA8	M3	GPIO
PA10	M4	GPIO	PA13	M5	GPIO (5V)
PA14	M6	GPIO	RESETn	M7	Reset input, active low. This pin is internally pulled up to AVDD. To apply an external reset source to this pin, it is required to only drive this pin low during reset, and let the internal pull-up ensure that reset is released.
PB12	M8	GPIO	PD0	M9	GPIO (5V)
PD2	M10	GPIO (5V)	PD3	M11	GPIO
PD4	M12	GPIO	PD8	M13	GPIO
PB8	N1	GPIO	PC5	N2	GPIO
PA9	N3	GPIO	PA11	N4	GPIO
PA12	N5	GPIO (5V)	PB11	N6	GPIO
BODEN	N7	Brown-Out Detector Enable. This pin may be left disconnected or tied to AVDD.	PB13	N8	GPIO
PB14	N9	GPIO	AVDD	N10	Analog power supply.
PD5	N11	GPIO	PD6	N12	GPIO
PD7	N13	GPIO			

Note:

1. GPIO with 5V tolerance are indicated by (5V).
2. The pins PD13, PD14, and PD15 will not be 5V tolerant on all future devices. In order to preserve upgrade options with full hardware compatibility, do not use these pins with 5V domains.

5.2 EFM32GG12B5xx in BGA120 Device Pinout



Figure 5.2. EFM32GG12B5xx in BGA120 Device Pinout

The following table provides package pin connections and general descriptions of pin functionality. For detailed information on the supported features for each GPIO pin, see [5.20 GPIO Functionality Table](#) or [5.21 Alternate Functionality Overview](#).

Table 5.2. EFM32GG12B5xx in BGA120 Device Pinout

Pin Name	Pin(s)	Description	Pin Name	Pin(s)	Description
PE15	A1	GPIO	PE14	A2	GPIO
PE12	A3	GPIO	PE9	A4	GPIO
PD11	A5	GPIO	PD9	A6	GPIO
PF7	A7	GPIO	PF5	A8	GPIO
PF14	A9	GPIO (5V)	PF12	A10	GPIO (5V)
VREGI	A11	Input to 5 V regulator.	VREGO	A12	Decoupling for 5 V regulator and regulator output. Power for USB PHY in USB-enabled OPNs

Pin Name	Pin(s)	Description	Pin Name	Pin(s)	Description
PF11	A13	GPIO (5V)	PA15	B1	GPIO
PE13	B2	GPIO	PE11	B3	GPIO
PE8	B4	GPIO	PD12	B5	GPIO
PD10	B6	GPIO	PF8	B7	GPIO
PF6	B8	GPIO	PF13	B9	GPIO (5V)
PF4	B10	GPIO	PF3	B11	GPIO
NC	B12	No Connect.	PF10	B13	GPIO (5V)
PA1	C1	GPIO	PA0	C2	GPIO
PE10	C3	GPIO	PD13	C4	GPIO (5V)
VSS	C5 C8 H3 J3 K11 L5 L8	Ground	IOVDD1	C6	Digital IO power supply 1.
PF9	C7	GPIO	IOVDD0	C9 G3 J11 K3 L4 L9	Digital IO power supply 0.
PF2	C10	GPIO	PF1	C11	GPIO (5V)
PC14	C12	GPIO (5V)	PC15	C13	GPIO (5V)
PA3	D1	GPIO	PA2	D2	GPIO
PB15	D3	GPIO (5V)	PF0	D11	GPIO (5V)
PC12	D12	GPIO (5V)	PC13	D13	GPIO (5V)
PA6	E1	GPIO	PA5	E2	GPIO
PA4	E3	GPIO	PC9	E11	GPIO (5V)
PC10	E12	GPIO (5V)	PC11	E13	GPIO (5V)
PB0	F1	GPIO	PB1	F2	GPIO
PB2	F3	GPIO	PE6	F11	GPIO
PE7	F12	GPIO	PC8	F13	GPIO (5V)
PB3	G1	GPIO	PB4	G2	GPIO
PE3	G11	GPIO	PE4	G12	GPIO
PE5	G13	GPIO	PB5	H1	GPIO
PB6	H2	GPIO	DVDD	H11	Digital power supply.
PE2	H12	GPIO	DECOUPLE	H13	Decouple output for on-chip voltage regulator. An external decoupling capacitor is required at this pin. This pin should not be used to power any external circuits.
PD14	J1	GPIO (5V)	PD15	J2	GPIO (5V)

Pin Name	Pin(s)	Description	Pin Name	Pin(s)	Description
PE1	J12	GPIO (5V)	VREGVDD	J13	Voltage regulator VDD input
PC0	K1	GPIO (5V)	PC1	K2	GPIO (5V)
PE0	K12	GPIO (5V)	VREGSW	K13	DCDC regulator switching node
PC2	L1	GPIO (5V)	PC3	L2	GPIO (5V)
PA7	L3	GPIO	PB9	L6	GPIO (5V)
PB10	L7	GPIO (5V)	PD1	L10	GPIO
PC6	L11	GPIO	PC7	L12	GPIO
VREGVSS	L13	Voltage regulator VSS	PB7	M1	GPIO
PC4	M2	GPIO	PA8	M3	GPIO
PA10	M4	GPIO	PA13	M5	GPIO (5V)
PA14	M6	GPIO	RESETn	M7	Reset input, active low. This pin is internally pulled up to AVDD. To apply an external reset source to this pin, it is required to only drive this pin low during reset, and let the internal pull-up ensure that reset is released.
PB12	M8	GPIO	PD0	M9	GPIO (5V)
PD2	M10	GPIO (5V)	PD3	M11	GPIO
PD4	M12	GPIO	PD8	M13	GPIO
PB8	N1	GPIO	PC5	N2	GPIO
PA9	N3	GPIO	PA11	N4	GPIO
PA12	N5	GPIO (5V)	PB11	N6	GPIO
BODEN	N7	Brown-Out Detector Enable. This pin may be left disconnected or tied to AVDD.	PB13	N8	GPIO
PB14	N9	GPIO	AVDD	N10	Analog power supply.
PD5	N11	GPIO	PD6	N12	GPIO
PD7	N13	GPIO			

Note:

1. GPIO with 5V tolerance are indicated by (5V).
2. The pins PD13, PD14, and PD15 will not be 5V tolerant on all future devices. In order to preserve upgrade options with full hardware compatibility, do not use these pins with 5V domains.

5.3 EFM32GG12B4xx in BGA120 Device Pinout



Figure 5.3. EFM32GG12B4xx in BGA120 Device Pinout

The following table provides package pin connections and general descriptions of pin functionality. For detailed information on the supported features for each GPIO pin, see [5.20 GPIO Functionality Table](#) or [5.21 Alternate Functionality Overview](#).

Table 5.3. EFM32GG12B4xx in BGA120 Device Pinout

Pin Name	Pin(s)	Description	Pin Name	Pin(s)	Description
PE15	A1	GPIO	PE14	A2	GPIO
PE12	A3	GPIO	PE9	A4	GPIO
PD11	A5	GPIO	PD9	A6	GPIO
PF7	A7	GPIO	PF5	A8	GPIO
PF4	A9	GPIO	PF2	A10	GPIO
VREGI	A11	Input to 5 V regulator.	VREGO	A12	Decoupling for 5 V regulator and regulator output. Power for USB PHY in USB-enabled OPNs

Pin Name	Pin(s)	Description	Pin Name	Pin(s)	Description
PF11	A13	GPIO (5V)	PA15	B1	GPIO
PE13	B2	GPIO	PE11	B3	GPIO
PE8	B4	GPIO	PD12	B5	GPIO
PD10	B6	GPIO	PF8	B7	GPIO
PF6	B8	GPIO	PF3	B9	GPIO
PF1	B10	GPIO (5V)	PF12	B11	GPIO (5V)
VBUS	B12	USB VBUS signal and auxiliary input to 5 V regulator.	PF10	B13	GPIO (5V)
PA1	C1	GPIO	PA0	C2	GPIO
PE10	C3	GPIO	PD13	C4	GPIO (5V)
VSS	C5 C8 H3 J3 K11 K12 L5 L6 M8 M11 N8	Ground	IOVDD1	C6	Digital IO power supply 1.
PF9	C7	GPIO	IOVDD0	C9 G3 J11 K3 L4 L7	Digital IO power supply 0.
PF0	C10	GPIO (5V)	PE4	C11	GPIO
PC14	C12	GPIO (5V)	PC15	C13	GPIO (5V)
PA3	D1	GPIO	PA2	D2	GPIO
PB15	D3	GPIO (5V)	PE5	D11	GPIO
PC12	D12	GPIO (5V)	PC13	D13	GPIO (5V)
PA6	E1	GPIO	PA5	E2	GPIO
PA4	E3	GPIO	PE6	E11	GPIO
PC10	E12	GPIO (5V)	PC11	E13	GPIO (5V)
PB0	F1	GPIO	PB1	F2	GPIO
PB2	F3	GPIO	PE7	F11	GPIO
PC8	F12	GPIO (5V)	PC9	F13	GPIO (5V)
PB3	G1	GPIO	PB4	G2	GPIO
PE0	G11	GPIO (5V)	PE1	G12	GPIO (5V)
PE3	G13	GPIO	PB5	H1	GPIO
PB6	H2	GPIO	DVDD	H11	Digital power supply.
PE2	H12	GPIO	PC7	H13	GPIO
PD14	J1	GPIO (5V)	PD15	J2	GPIO (5V)

Pin Name	Pin(s)	Description	Pin Name	Pin(s)	Description
PC6	J12	GPIO	DECOUPLE	J13	Decouple output for on-chip voltage regulator. An external decoupling capacitor is required at this pin. This pin should not be used to power any external circuits.
PC0	K1	GPIO (5V)	PC1	K2	GPIO (5V)
PD8	K13	GPIO	PC2	L1	GPIO (5V)
PC3	L2	GPIO (5V)	PA7	L3	GPIO
PB9	L8	GPIO (5V)	PB10	L9	GPIO (5V)
PD0	L10	GPIO (5V)	PD1	L11	GPIO
PD4	L12	GPIO	PD7	L13	GPIO
PB7	M1	GPIO	PC4	M2	GPIO
PA8	M3	GPIO	PA10	M4	GPIO
PA13	M5	GPIO (5V)	PA14	M6	GPIO
RESETn	M7	Reset input, active low. This pin is internally pulled up to AVDD. To apply an external reset source to this pin, it is required to only drive this pin low during reset, and let the internal pull-up ensure that reset is released.	AVDD	M9 M10 N11	Analog power supply.
PD3	M12	GPIO	PD6	M13	GPIO
PB8	N1	GPIO	PC5	N2	GPIO
PA9	N3	GPIO	PA11	N4	GPIO
PA12	N5	GPIO (5V)	PB11	N6	GPIO
PB12	N7	GPIO	PB13	N9	GPIO
PB14	N10	GPIO	PD2	N12	GPIO (5V)
PD5	N13	GPIO			

Note:

- GPIO with 5V tolerance are indicated by (5V).
- The pins PD13, PD14, and PD15 will not be 5V tolerant on all future devices. In order to preserve upgrade options with full hardware compatibility, do not use these pins with 5V domains.

5.4 EFM32GG12B8xx in BGA112 Device Pinout

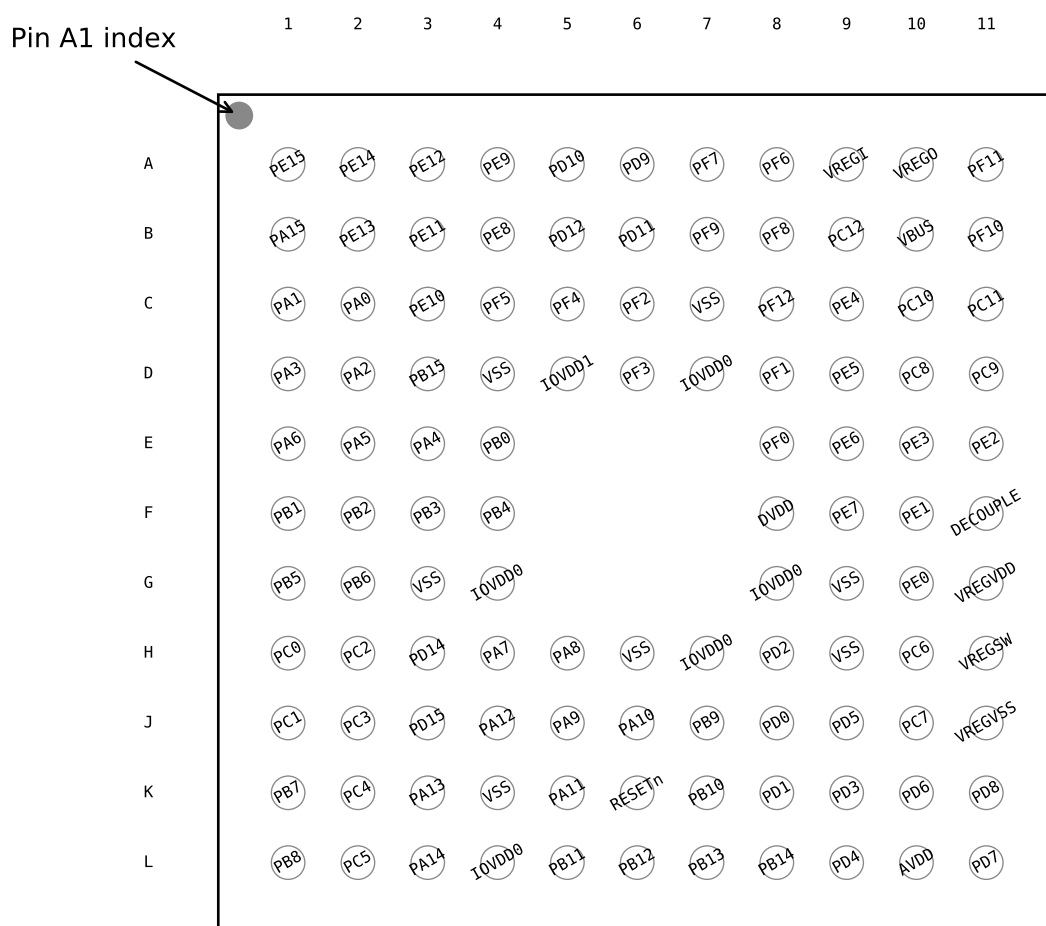

Figure 5.4. EFM32GG12B8xx in BGA112 Device Pinout

The following table provides package pin connections and general descriptions of pin functionality. For detailed information on the supported features for each GPIO pin, see [5.20 GPIO Functionality Table](#) or [5.21 Alternate Functionality Overview](#).

Table 5.4. EFM32GG12B8xx in BGA112 Device Pinout

Pin Name	Pin(s)	Description	Pin Name	Pin(s)	Description
PE15	A1	GPIO	PE14	A2	GPIO
PE12	A3	GPIO	PE9	A4	GPIO
PD10	A5	GPIO	PD9	A6	GPIO
PF7	A7	GPIO	PF6	A8	GPIO
VREGI	A9	Input to 5 V regulator.	VREGO	A10	Decoupling for 5 V regulator and regulator output. Power for USB PHY in USB-enabled OPNs
PF11	A11	GPIO (5V)	PA15	B1	GPIO

Pin Name	Pin(s)	Description	Pin Name	Pin(s)	Description
PE13	B2	GPIO	PE11	B3	GPIO
PE8	B4	GPIO	PD12	B5	GPIO
PD11	B6	GPIO	PF9	B7	GPIO
PF8	B8	GPIO	PC12	B9	GPIO (5V)
VBUS	B10	USB VBUS signal and auxiliary input to 5 V regulator.	PF10	B11	GPIO (5V)
PA1	C1	GPIO	PA0	C2	GPIO
PE10	C3	GPIO	PF5	C4	GPIO
PF4	C5	GPIO	PF2	C6	GPIO
VSS	C7 D4 G3 G9 H6 H9 K4	Ground	PF12	C8	GPIO (5V)
PE4	C9	GPIO	PC10	C10	GPIO (5V)
PC11	C11	GPIO (5V)	PA3	D1	GPIO
PA2	D2	GPIO	PB15	D3	GPIO (5V)
IOVDD1	D5	Digital IO power supply 1.	PF3	D6	GPIO
IOVDD0	D7 G4 G8 H7 L4	Digital IO power supply 0.	PF1	D8	GPIO (5V)
PE5	D9	GPIO	PC8	D10	GPIO (5V)
PC9	D11	GPIO (5V)	PA6	E1	GPIO
PA5	E2	GPIO	PA4	E3	GPIO
PB0	E4	GPIO	PF0	E8	GPIO (5V)
PE6	E9	GPIO	PE3	E10	GPIO
PE2	E11	GPIO	PB1	F1	GPIO
PB2	F2	GPIO	PB3	F3	GPIO
PB4	F4	GPIO	DVDD	F8	Digital power supply.
PE7	F9	GPIO	PE1	F10	GPIO (5V)
DECOUPLE	F11	Decouple output for on-chip voltage regulator. An external decoupling capacitor is required at this pin. This pin should not be used to power any external circuits.	PB5	G1	GPIO
PB6	G2	GPIO	PE0	G10	GPIO (5V)
VREGVDD	G11	Voltage regulator VDD input	PC0	H1	GPIO (5V)
PC2	H2	GPIO (5V)	PD14	H3	GPIO (5V)
PA7	H4	GPIO	PA8	H5	GPIO

Pin Name	Pin(s)	Description	Pin Name	Pin(s)	Description
PD2	H8	GPIO (5V)	PC6	H10	GPIO
VREGSW	H11	DCDC regulator switching node	PC1	J1	GPIO (5V)
PC3	J2	GPIO (5V)	PD15	J3	GPIO (5V)
PA12	J4	GPIO (5V)	PA9	J5	GPIO
PA10	J6	GPIO	PB9	J7	GPIO (5V)
PD0	J8	GPIO (5V)	PD5	J9	GPIO
PC7	J10	GPIO	VREGVSS	J11	Voltage regulator VSS
PB7	K1	GPIO	PC4	K2	GPIO
PA13	K3	GPIO (5V)	PA11	K5	GPIO
RESETn	K6	Reset input, active low. This pin is internally pulled up to AVDD. To apply an external reset source to this pin, it is required to only drive this pin low during reset, and let the internal pull-up ensure that reset is released.	PB10	K7	GPIO (5V)
PD1	K8	GPIO	PD3	K9	GPIO
PD6	K10	GPIO	PD8	K11	GPIO
PB8	L1	GPIO	PC5	L2	GPIO
PA14	L3	GPIO	PB11	L5	GPIO
PB12	L6	GPIO	PB13	L7	GPIO
PB14	L8	GPIO	PD4	L9	GPIO
AVDD	L10	Analog power supply.	PD7	L11	GPIO

Note:

1. GPIO with 5V tolerance are indicated by (5V).
2. The pins PD14, and PD15 will not be 5V tolerant on all future devices. In order to preserve upgrade options with full hardware compatibility, do not use these pins with 5V domains.

5.5 EFM32GG12B5xx in BGA112 Device Pinout

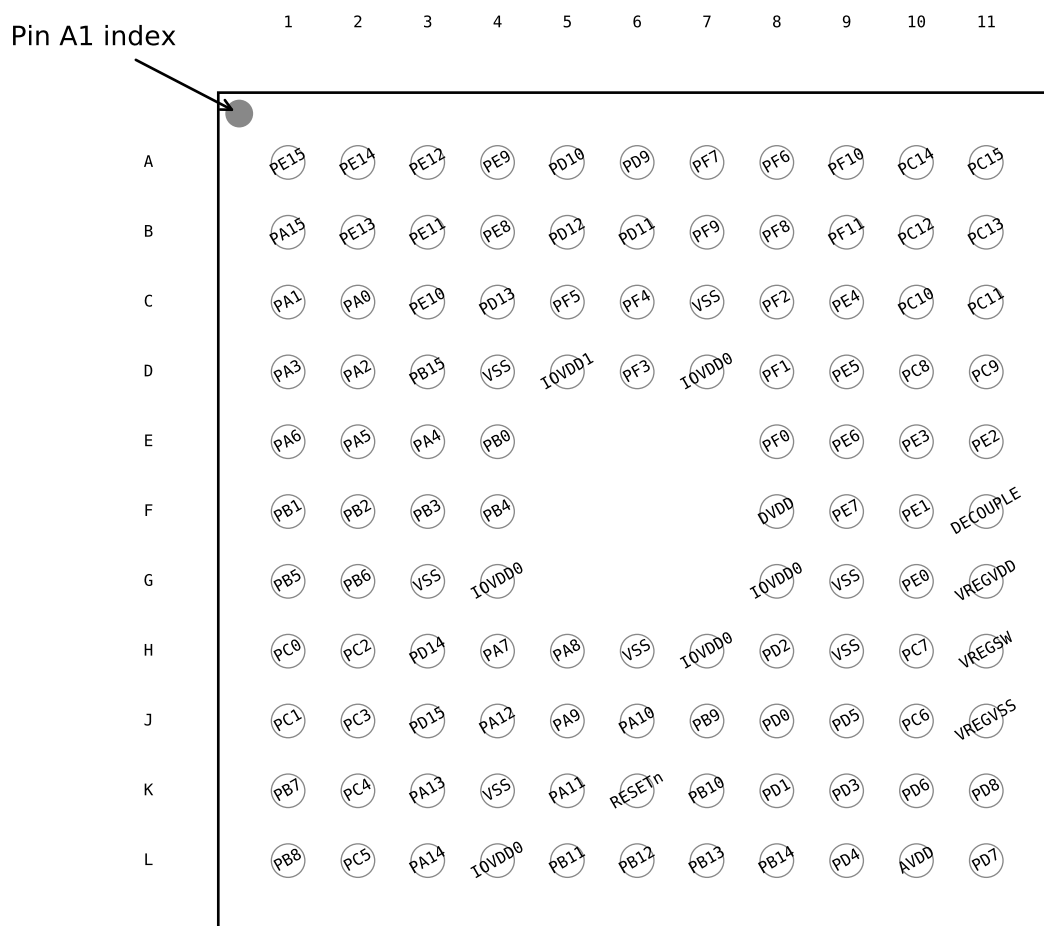

Figure 5.5. EFM32GG12B5xx in BGA112 Device Pinout

The following table provides package pin connections and general descriptions of pin functionality. For detailed information on the supported features for each GPIO pin, see [5.20 GPIO Functionality Table](#) or [5.21 Alternate Functionality Overview](#).

Table 5.5. EFM32GG12B5xx in BGA112 Device Pinout

Pin Name	Pin(s)	Description	Pin Name	Pin(s)	Description
PE15	A1	GPIO	PE14	A2	GPIO
PE12	A3	GPIO	PE9	A4	GPIO
PD10	A5	GPIO	PD9	A6	GPIO
PF7	A7	GPIO	PF6	A8	GPIO
PF10	A9	GPIO (5V)	PC14	A10	GPIO (5V)
PC15	A11	GPIO (5V)	PA15	B1	GPIO
PE13	B2	GPIO	PE11	B3	GPIO

Pin Name	Pin(s)	Description	Pin Name	Pin(s)	Description
PE8	B4	GPIO	PD12	B5	GPIO
PD11	B6	GPIO	PF9	B7	GPIO
PF8	B8	GPIO	PF11	B9	GPIO (5V)
PC12	B10	GPIO (5V)	PC13	B11	GPIO (5V)
PA1	C1	GPIO	PA0	C2	GPIO
PE10	C3	GPIO	PD13	C4	GPIO (5V)
PF5	C5	GPIO	PF4	C6	GPIO
VSS	C7 D4 G3 G9 H6 H9 K4	Ground	PF2	C8	GPIO
PE4	C9	GPIO	PC10	C10	GPIO (5V)
PC11	C11	GPIO (5V)	PA3	D1	GPIO
PA2	D2	GPIO	PB15	D3	GPIO (5V)
IOVDD1	D5	Digital IO power supply 1.	PF3	D6	GPIO
IOVDD0	D7 G4 G8 H7 L4	Digital IO power supply 0.	PF1	D8	GPIO (5V)
PE5	D9	GPIO	PC8	D10	GPIO (5V)
PC9	D11	GPIO (5V)	PA6	E1	GPIO
PA5	E2	GPIO	PA4	E3	GPIO
PB0	E4	GPIO	PF0	E8	GPIO (5V)
PE6	E9	GPIO	PE3	E10	GPIO
PE2	E11	GPIO	PB1	F1	GPIO
PB2	F2	GPIO	PB3	F3	GPIO
PB4	F4	GPIO	DVDD	F8	Digital power supply.
PE7	F9	GPIO	PE1	F10	GPIO (5V)
DECOUPLE	F11	Decouple output for on-chip voltage regulator. An external decoupling capacitor is required at this pin. This pin should not be used to power any external circuits.	PB5	G1	GPIO
PB6	G2	GPIO	PE0	G10	GPIO (5V)
VREGVDD	G11	Voltage regulator VDD input	PC0	H1	GPIO (5V)
PC2	H2	GPIO (5V)	PD14	H3	GPIO (5V)
PA7	H4	GPIO	PA8	H5	GPIO
PD2	H8	GPIO (5V)	PC7	H10	GPIO
VREGSW	H11	DCDC regulator switching node	PC1	J1	GPIO (5V)

Pin Name	Pin(s)	Description	Pin Name	Pin(s)	Description
PC3	J2	GPIO (5V)	PD15	J3	GPIO (5V)
PA12	J4	GPIO (5V)	PA9	J5	GPIO
PA10	J6	GPIO	PB9	J7	GPIO (5V)
PD0	J8	GPIO (5V)	PD5	J9	GPIO
PC6	J10	GPIO	VREGVSS	J11	Voltage regulator VSS
PB7	K1	GPIO	PC4	K2	GPIO
PA13	K3	GPIO (5V)	PA11	K5	GPIO
RESETn	K6	Reset input, active low. This pin is internally pulled up to AVDD. To apply an external reset source to this pin, it is required to only drive this pin low during reset, and let the internal pull-up ensure that reset is released.	PB10	K7	GPIO (5V)
PD1	K8	GPIO	PD3	K9	GPIO
PD6	K10	GPIO	PD8	K11	GPIO
PB8	L1	GPIO	PC5	L2	GPIO
PA14	L3	GPIO	PB11	L5	GPIO
PB12	L6	GPIO	PB13	L7	GPIO
PB14	L8	GPIO	PD4	L9	GPIO
AVDD	L10	Analog power supply.	PD7	L11	GPIO

Note:

1. GPIO with 5V tolerance are indicated by (5V).
2. The pins PD13, PD14, and PD15 will not be 5V tolerant on all future devices. In order to preserve upgrade options with full hardware compatibility, do not use these pins with 5V domains.

5.6 EFM32GG12B4xx in BGA112 Device Pinout



Figure 5.6. EFM32GG12B4xx in BGA112 Device Pinout

The following table provides package pin connections and general descriptions of pin functionality. For detailed information on the supported features for each GPIO pin, see [5.20 GPIO Functionality Table](#) or [5.21 Alternate Functionality Overview](#).

Table 5.6. EFM32GG12B4xx in BGA112 Device Pinout

Pin Name	Pin(s)	Description	Pin Name	Pin(s)	Description
PE15	A1	GPIO	PE14	A2	GPIO
PE12	A3	GPIO	PE9	A4	GPIO
PD10	A5	GPIO	PF7	A6	GPIO
PF5	A7	GPIO	PF12	A8	GPIO (5V)
PE4	A9	GPIO	PF10	A10	GPIO (5V)
PF11	A11	GPIO (5V)	PA15	B1	GPIO
PE13	B2	GPIO	PE11	B3	GPIO

Pin Name	Pin(s)	Description	Pin Name	Pin(s)	Description
PE8	B4	GPIO	PD11	B5	GPIO
PF8	B6	GPIO	PF6	B7	GPIO
VBUS	B8	USB VBUS signal and auxiliary input to 5 V regulator.	PE5	B9	GPIO
VREGI	B10	Input to 5 V regulator.	VREGO	B11	Decoupling for 5 V regulator and regulator output. Power for USB PHY in USB-enabled OPNs
PA1	C1	GPIO	PA0	C2	GPIO
PE10	C3	GPIO	PD13	C4	GPIO (5V)
PD12	C5	GPIO	PF9	C6	GPIO
VSS	C7 D4 F9 G3 G9 H6 K4 K7 K10 L7	Ground	PF2	C8	GPIO
PE6	C9	GPIO	PC10	C10	GPIO (5V)
PC11	C11	GPIO (5V)	PA3	D1	GPIO
PA2	D2	GPIO	PB15	D3	GPIO (5V)
IOVDD1	D5	Digital IO power supply 1.	PD9	D6	GPIO
IOVDD0	D7 G4 G8 H7 L4	Digital IO power supply 0.	PF1	D8	GPIO (5V)
PE7	D9	GPIO	PC8	D10	GPIO (5V)
PC9	D11	GPIO (5V)	PA6	E1	GPIO
PA5	E2	GPIO	PA4	E3	GPIO
PB0	E4	GPIO	PF0	E8	GPIO (5V)
PE0	E9	GPIO (5V)	PE1	E10	GPIO (5V)
PE3	E11	GPIO	PB1	F1	GPIO
PB2	F2	GPIO	PB3	F3	GPIO
PB4	F4	GPIO	DVDD	F8	Digital power supply.
PE2	F10	GPIO	DECOUPLE	F11	Decouple output for on-chip voltage regulator. An external decoupling capacitor is required at this pin. This pin should not be used to power any external circuits.
PB5	G1	GPIO	PB6	G2	GPIO
PC6	G10	GPIO	PC7	G11	GPIO
PC0	H1	GPIO (5V)	PC2	H2	GPIO (5V)

Pin Name	Pin(s)	Description	Pin Name	Pin(s)	Description
PD14	H3	GPIO (5V)	PA7	H4	GPIO
PA8	H5	GPIO	PD8	H8	GPIO
PD5	H9	GPIO	PD6	H10	GPIO
PD7	H11	GPIO	PC1	J1	GPIO (5V)
PC3	J2	GPIO (5V)	PD15	J3	GPIO (5V)
PA12	J4	GPIO (5V)	PA9	J5	GPIO
PA10	J6	GPIO	PB9	J7	GPIO (5V)
PB10	J8	GPIO (5V)	PD2	J9	GPIO (5V)
PD3	J10	GPIO	PD4	J11	GPIO
PB7	K1	GPIO	PC4	K2	GPIO
PA13	K3	GPIO (5V)	PA11	K5	GPIO
RESETn	K6	Reset input, active low. This pin is internally pulled up to AVDD. To apply an external reset source to this pin, it is required to only drive this pin low during reset, and let the internal pull-up ensure that reset is released.	AVDD	K8 K9 L10	Analog power supply.
PD1	K11	GPIO	PB8	L1	GPIO
PC5	L2	GPIO	PA14	L3	GPIO
PB11	L5	GPIO	PB12	L6	GPIO
PB13	L8	GPIO	PB14	L9	GPIO
PD0	L11	GPIO (5V)			

Note:

- GPIO with 5V tolerance are indicated by (5V).
- The pins PD13, PD14, and PD15 will not be 5V tolerant on all future devices. In order to preserve upgrade options with full hardware compatibility, do not use these pins with 5V domains.

5.7 EFM32GG12B3xx in BGA112 Device Pinout

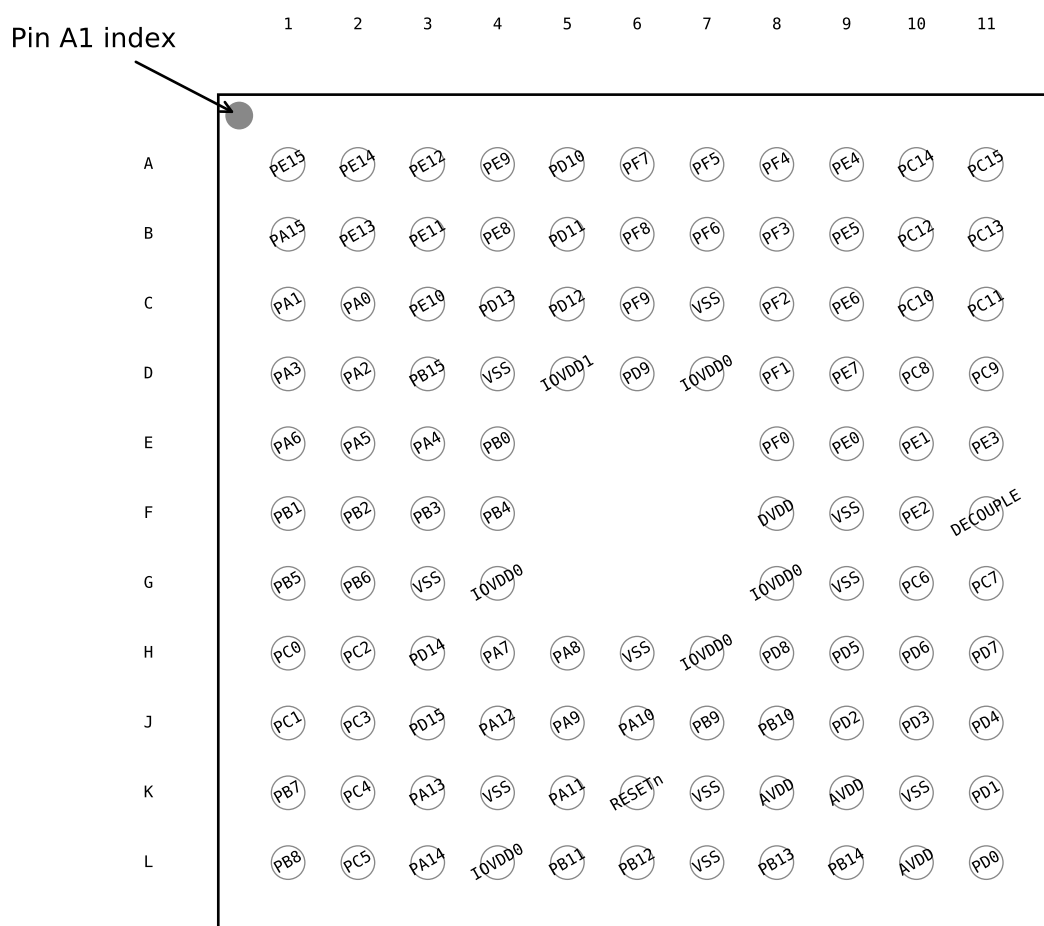

Figure 5.7. EFM32GG12B3xx in BGA112 Device Pinout

The following table provides package pin connections and general descriptions of pin functionality. For detailed information on the supported features for each GPIO pin, see [5.20 GPIO Functionality Table](#) or [5.21 Alternate Functionality Overview](#).

Table 5.7. EFM32GG12B3xx in BGA112 Device Pinout

Pin Name	Pin(s)	Description	Pin Name	Pin(s)	Description
PE15	A1	GPIO	PE14	A2	GPIO
PE12	A3	GPIO	PE9	A4	GPIO
PD10	A5	GPIO	PF7	A6	GPIO
PF5	A7	GPIO	PF4	A8	GPIO
PE4	A9	GPIO	PC14	A10	GPIO (5V)
PC15	A11	GPIO (5V)	PA15	B1	GPIO
PE13	B2	GPIO	PE11	B3	GPIO

Pin Name	Pin(s)	Description	Pin Name	Pin(s)	Description
PE8	B4	GPIO	PD11	B5	GPIO
PF8	B6	GPIO	PF6	B7	GPIO
PF3	B8	GPIO	PE5	B9	GPIO
PC12	B10	GPIO (5V)	PC13	B11	GPIO (5V)
PA1	C1	GPIO	PA0	C2	GPIO
PE10	C3	GPIO	PD13	C4	GPIO (5V)
PD12	C5	GPIO	PF9	C6	GPIO
VSS	C7 D4 F9 G3 G9 H6 K4 K7 K10 L7	Ground	PF2	C8	GPIO
PE6	C9	GPIO	PC10	C10	GPIO (5V)
PC11	C11	GPIO (5V)	PA3	D1	GPIO
PA2	D2	GPIO	PB15	D3	GPIO (5V)
IOVDD1	D5	Digital IO power supply 1.	PD9	D6	GPIO
IOVDD0	D7 G4 G8 H7 L4	Digital IO power supply 0.	PF1	D8	GPIO (5V)
PE7	D9	GPIO	PC8	D10	GPIO (5V)
PC9	D11	GPIO (5V)	PA6	E1	GPIO
PA5	E2	GPIO	PA4	E3	GPIO
PB0	E4	GPIO	PF0	E8	GPIO (5V)
PE0	E9	GPIO (5V)	PE1	E10	GPIO (5V)
PE3	E11	GPIO	PB1	F1	GPIO
PB2	F2	GPIO	PB3	F3	GPIO
PB4	F4	GPIO	DVDD	F8	Digital power supply.
PE2	F10	GPIO	DECOUPLE	F11	Decouple output for on-chip voltage regulator. An external decoupling capacitor is required at this pin. This pin should not be used to power any external circuits.
PB5	G1	GPIO	PB6	G2	GPIO
PC6	G10	GPIO	PC7	G11	GPIO
PC0	H1	GPIO (5V)	PC2	H2	GPIO (5V)
PD14	H3	GPIO (5V)	PA7	H4	GPIO
PA8	H5	GPIO	PD8	H8	GPIO

Pin Name	Pin(s)	Description	Pin Name	Pin(s)	Description
PD5	H9	GPIO	PD6	H10	GPIO
PD7	H11	GPIO	PC1	J1	GPIO (5V)
PC3	J2	GPIO (5V)	PD15	J3	GPIO (5V)
PA12	J4	GPIO (5V)	PA9	J5	GPIO
PA10	J6	GPIO	PB9	J7	GPIO (5V)
PB10	J8	GPIO (5V)	PD2	J9	GPIO (5V)
PD3	J10	GPIO	PD4	J11	GPIO
PB7	K1	GPIO	PC4	K2	GPIO
PA13	K3	GPIO (5V)	PA11	K5	GPIO
RESETn	K6	Reset input, active low. This pin is internally pulled up to AVDD. To apply an external reset source to this pin, it is required to only drive this pin low during reset, and let the internal pull-up ensure that reset is released.	AVDD	K8 K9 L10	Analog power supply.
PD1	K11	GPIO	PB8	L1	GPIO
PC5	L2	GPIO	PA14	L3	GPIO
PB11	L5	GPIO	PB12	L6	GPIO
PB13	L8	GPIO	PB14	L9	GPIO
PD0	L11	GPIO (5V)			

Note:

1. GPIO with 5V tolerance are indicated by (5V).
2. The pins PD13, PD14, and PD15 will not be 5V tolerant on all future devices. In order to preserve upgrade options with full hardware compatibility, do not use these pins with 5V domains.

5.8 EFM32GG12B8xx in QFP100 Device Pinout



Figure 5.8. EFM32GG12B8xx in QFP100 Device Pinout

The following table provides package pin connections and general descriptions of pin functionality. For detailed information on the supported features for each GPIO pin, see [5.20 GPIO Functionality Table](#) or [5.21 Alternate Functionality Overview](#).

Table 5.8. EFM32GG12B8xx in QFP100 Device Pinout

Pin Name	Pin(s)	Description	Pin Name	Pin(s)	Description
PA0	1	GPIO	PA1	2	GPIO
PA2	3	GPIO	PA3	4	GPIO
PA4	5	GPIO	PA5	6	GPIO
PA6	7	GPIO	IOVDD0	8, 17, 31, 44, 82	Digital IO power supply 0.
PB0	9	GPIO	PB1	10	GPIO

Pin Name	Pin(s)	Description	Pin Name	Pin(s)	Description
PB2	11	GPIO	PB3	12	GPIO
PB4	13	GPIO	PB5	14	GPIO
PB6	15	GPIO	VSS	16 32 59 83	Ground
PC0	18	GPIO (5V)	PC1	19	GPIO (5V)
PC2	20	GPIO (5V)	PC3	21	GPIO (5V)
PC4	22	GPIO	PC5	23	GPIO
PB7	24	GPIO	PB8	25	GPIO
PA7	26	GPIO	PA8	27	GPIO
PA9	28	GPIO	PA10	29	GPIO
PA11	30	GPIO	PA12	33	GPIO (5V)
PA13	34	GPIO (5V)	PA14	35	GPIO
RESETn	36	Reset input, active low. This pin is internally pulled up to AVDD. To apply an external reset source to this pin, it is required to only drive this pin low during reset, and let the internal pull-up ensure that reset is released.	PB9	37	GPIO (5V)
PB10	38	GPIO (5V)	PB11	39	GPIO
PB12	40	GPIO	AVDD	41	Analog power supply.
PB13	42	GPIO	PB14	43	GPIO
PD0	45	GPIO (5V)	PD1	46	GPIO
PD2	47	GPIO (5V)	PD3	48	GPIO
PD4	49	GPIO	PD5	50	GPIO
PD6	51	GPIO	PD7	52	GPIO
PD8	53	GPIO	PC7	54	GPIO
VREGVSS	55	Voltage regulator VSS	VREGSW	56	DCDC regulator switching node
VREGVDD	57	Voltage regulator VDD input	DVDD	58	Digital power supply.
DECOUPLE	60	Decouple output for on-chip voltage regulator. An external decoupling capacitor is required at this pin. This pin should not be used to power any external circuits.	PE1	61	GPIO (5V)
PE2	62	GPIO	PE3	63	GPIO
PE4	64	GPIO	PE5	65	GPIO
PE6	66	GPIO	PE7	67	GPIO
PC8	68	GPIO (5V)	PC9	69	GPIO (5V)
PC10	70	GPIO (5V)	PC11	71	GPIO (5V)
VREGI	72	Input to 5 V regulator.	VREGO	73	Decoupling for 5 V regulator and regulator output. Power for USB PHY in USB-enabled OPNs

Pin Name	Pin(s)	Description	Pin Name	Pin(s)	Description
PF10	74	GPIO (5V)	PF11	75	GPIO (5V)
PF0	76	GPIO (5V)	PF1	77	GPIO (5V)
PF2	78	GPIO	VBUS	79	USB VBUS signal and auxiliary input to 5 V regulator.
PF12	80	GPIO (5V)	PF5	81	GPIO
PF6	84	GPIO	PF7	85	GPIO
PF8	86	GPIO	PF9	87	GPIO
PD9	88	GPIO	PD10	89	GPIO
PD11	90	GPIO	PD12	91	GPIO
PE8	92	GPIO	PE9	93	GPIO
PE10	94	GPIO	PE11	95	GPIO
PE12	96	GPIO	PE13	97	GPIO
PE14	98	GPIO	PE15	99	GPIO
PA15	100	GPIO			

Note:

1. GPIO with 5V tolerance are indicated by (5V).

5.9 EFM32GG12B5xx in QFP100 Device Pinout



Figure 5.9. EFM32GG12B5xx in QFP100 Device Pinout

The following table provides package pin connections and general descriptions of pin functionality. For detailed information on the supported features for each GPIO pin, see [5.20 GPIO Functionality Table](#) or [5.21 Alternate Functionality Overview](#).

Table 5.9. EFM32GG12B5xx in QFP100 Device Pinout

Pin Name	Pin(s)	Description	Pin Name	Pin(s)	Description
PA0	1	GPIO	PA1	2	GPIO
PA2	3	GPIO	PA3	4	GPIO
PA4	5	GPIO	PA5	6	GPIO
PA6	7	GPIO	IOVDD0	8, 17, 31, 44, 82	Digital IO power supply 0.
PB0	9	GPIO	PB1	10	GPIO

Pin Name	Pin(s)	Description	Pin Name	Pin(s)	Description
PB2	11	GPIO	PB3	12	GPIO
PB4	13	GPIO	PB5	14	GPIO
PB6	15	GPIO	VSS	16 32 59 83	Ground
PC0	18	GPIO (5V)	PC1	19	GPIO (5V)
PC2	20	GPIO (5V)	PC3	21	GPIO (5V)
PC4	22	GPIO	PC5	23	GPIO
PB7	24	GPIO	PB8	25	GPIO
PA7	26	GPIO	PA8	27	GPIO
PA9	28	GPIO	PA10	29	GPIO
PA11	30	GPIO	PA12	33	GPIO (5V)
PA13	34	GPIO (5V)	PA14	35	GPIO
RESETn	36	Reset input, active low. This pin is internally pulled up to AVDD. To apply an external reset source to this pin, it is required to only drive this pin low during reset, and let the internal pull-up ensure that reset is released.	PB9	37	GPIO (5V)
PB10	38	GPIO (5V)	PB11	39	GPIO
PB12	40	GPIO	AVDD	41	Analog power supply.
PB13	42	GPIO	PB14	43	GPIO
PD0	45	GPIO (5V)	PD1	46	GPIO
PD2	47	GPIO (5V)	PD3	48	GPIO
PD4	49	GPIO	PD5	50	GPIO
PD6	51	GPIO	PD7	52	GPIO
PD8	53	GPIO	PC7	54	GPIO
VREGVSS	55	Voltage regulator VSS	VREGSW	56	DCDC regulator switching node
VREGVDD	57	Voltage regulator VDD input	DVDD	58	Digital power supply.
DECOUPLE	60	Decouple output for on-chip voltage regulator. An external decoupling capacitor is required at this pin. This pin should not be used to power any external circuits.	PE1	61	GPIO (5V)
PE2	62	GPIO	PE3	63	GPIO
PE4	64	GPIO	PE5	65	GPIO
PE6	66	GPIO	PE7	67	GPIO
PC8	68	GPIO (5V)	PC9	69	GPIO (5V)
PC10	70	GPIO (5V)	PC11	71	GPIO (5V)
VREGI	72	Input to 5 V regulator.	VREGO	73	Decoupling for 5 V regulator and regulator output. Power for USB PHY in USB-enabled OPNs

Pin Name	Pin(s)	Description	Pin Name	Pin(s)	Description
PF10	74	GPIO (5V)	PF11	75	GPIO (5V)
PF0	76	GPIO (5V)	PF1	77	GPIO (5V)
PF2	78	GPIO	NC	79	No Connect.
PF12	80	GPIO (5V)	PF5	81	GPIO
PF6	84	GPIO	PF7	85	GPIO
PF8	86	GPIO	PF9	87	GPIO
PD9	88	GPIO	PD10	89	GPIO
PD11	90	GPIO	PD12	91	GPIO
PE8	92	GPIO	PE9	93	GPIO
PE10	94	GPIO	PE11	95	GPIO
PE12	96	GPIO	PE13	97	GPIO
PE14	98	GPIO	PE15	99	GPIO
PA15	100	GPIO			

Note:

1. GPIO with 5V tolerance are indicated by (5V).

5.10 EFM32GG12B4xx in QFP100 Device Pinout



Figure 5.10. EFM32GG12B4xx in QFP100 Device Pinout

The following table provides package pin connections and general descriptions of pin functionality. For detailed information on the supported features for each GPIO pin, see [5.20 GPIO Functionality Table](#) or [5.21 Alternate Functionality Overview](#).

Table 5.10. EFM32GG12B4xx in QFP100 Device Pinout

Pin Name	Pin(s)	Description	Pin Name	Pin(s)	Description
PA0	1	GPIO	PA1	2	GPIO
PA2	3	GPIO	PA3	4	GPIO
PA4	5	GPIO	PA5	6	GPIO
PA6	7	GPIO	IOVDD0	8, 17, 31, 44, 82	Digital IO power supply 0.
PB0	9	GPIO	PB1	10	GPIO

Pin Name	Pin(s)	Description	Pin Name	Pin(s)	Description
PB2	11	GPIO	PB3	12	GPIO
PB4	13	GPIO	PB5	14	GPIO
PB6	15	GPIO	VSS	16 32 58 83	Ground
PC0	18	GPIO (5V)	PC1	19	GPIO (5V)
PC2	20	GPIO (5V)	PC3	21	GPIO (5V)
PC4	22	GPIO	PC5	23	GPIO
PB7	24	GPIO	PB8	25	GPIO
PA7	26	GPIO	PA8	27	GPIO
PA9	28	GPIO	PA10	29	GPIO
PA11	30	GPIO	PA12	33	GPIO (5V)
PA13	34	GPIO (5V)	PA14	35	GPIO
RESETn	36	Reset input, active low. This pin is internally pulled up to AVDD. To apply an external reset source to this pin, it is required to only drive this pin low during reset, and let the internal pull-up ensure that reset is released.	PB9	37	GPIO (5V)
PB10	38	GPIO (5V)	PB11	39	GPIO
PB12	40	GPIO	AVDD	41 45	Analog power supply.
PB13	42	GPIO	PB14	43	GPIO
PD0	46	GPIO (5V)	PD1	47	GPIO
PD2	48	GPIO (5V)	PD3	49	GPIO
PD4	50	GPIO	PD5	51	GPIO
PD6	52	GPIO	PD7	53	GPIO
PD8	54	GPIO	PC6	55	GPIO
PC7	56	GPIO	DVDD	57	Digital power supply.
DECOUPLE	59	Decouple output for on-chip voltage regulator. An external decoupling capacitor is required at this pin. This pin should not be used to power any external circuits.	PE0	60	GPIO (5V)
PE1	61	GPIO (5V)	PE2	62	GPIO
PE3	63	GPIO	PE4	64	GPIO
PE5	65	GPIO	PE6	66	GPIO
PE7	67	GPIO	PC8	68	GPIO (5V)
PC9	69	GPIO (5V)	PC10	70	GPIO (5V)
PC11	71	GPIO (5V)	VREGI	72	Input to 5 V regulator.

Pin Name	Pin(s)	Description	Pin Name	Pin(s)	Description
VREGO	73	Decoupling for 5 V regulator and regulator output. Power for USB PHY in USB-enabled OPNs	PF10	74	GPIO (5V)
PF11	75	GPIO (5V)	PF0	76	GPIO (5V)
PF1	77	GPIO (5V)	PF2	78	GPIO
VBUS	79	USB VBUS signal and auxiliary input to 5 V regulator.	PF12	80	GPIO (5V)
PF5	81	GPIO	PF6	84	GPIO
PF7	85	GPIO	PF8	86	GPIO
PF9	87	GPIO	PD9	88	GPIO
PD10	89	GPIO	PD11	90	GPIO
PD12	91	GPIO	PE8	92	GPIO
PE9	93	GPIO	PE10	94	GPIO
PE11	95	GPIO	PE12	96	GPIO
PE13	97	GPIO	PE14	98	GPIO
PE15	99	GPIO	PA15	100	GPIO

Note:

1. GPIO with 5V tolerance are indicated by (5V).

5.11 EFM32GG12B3xx in QFP100 Device Pinout



Figure 5.11. EFM32GG12B3xx in QFP100 Device Pinout

The following table provides package pin connections and general descriptions of pin functionality. For detailed information on the supported features for each GPIO pin, see [5.20 GPIO Functionality Table](#) or [5.21 Alternate Functionality Overview](#).

Table 5.11. EFM32GG12B3xx in QFP100 Device Pinout

Pin Name	Pin(s)	Description	Pin Name	Pin(s)	Description
PA0	1	GPIO	PA1	2	GPIO
PA2	3	GPIO	PA3	4	GPIO
PA4	5	GPIO	PA5	6	GPIO
PA6	7	GPIO	IOVDD0	8, 17, 31, 44, 82	Digital IO power supply 0.
PB0	9	GPIO	PB1	10	GPIO

Pin Name	Pin(s)	Description	Pin Name	Pin(s)	Description
PB2	11	GPIO	PB3	12	GPIO
PB4	13	GPIO	PB5	14	GPIO
PB6	15	GPIO	VSS	16 32 58 83	Ground
PC0	18	GPIO (5V)	PC1	19	GPIO (5V)
PC2	20	GPIO (5V)	PC3	21	GPIO (5V)
PC4	22	GPIO	PC5	23	GPIO
PB7	24	GPIO	PB8	25	GPIO
PA7	26	GPIO	PA8	27	GPIO
PA9	28	GPIO	PA10	29	GPIO
PA11	30	GPIO	PA12	33	GPIO (5V)
PA13	34	GPIO (5V)	PA14	35	GPIO
RESETn	36	Reset input, active low. This pin is internally pulled up to AVDD. To apply an external reset source to this pin, it is required to only drive this pin low during reset, and let the internal pull-up ensure that reset is released.	PB9	37	GPIO (5V)
PB10	38	GPIO (5V)	PB11	39	GPIO
PB12	40	GPIO	AVDD	41 45	Analog power supply.
PB13	42	GPIO	PB14	43	GPIO
PD0	46	GPIO (5V)	PD1	47	GPIO
PD2	48	GPIO (5V)	PD3	49	GPIO
PD4	50	GPIO	PD5	51	GPIO
PD6	52	GPIO	PD7	53	GPIO
PD8	54	GPIO	PC6	55	GPIO
PC7	56	GPIO	DVDD	57	Digital power supply.
DECOUPLE	59	Decouple output for on-chip voltage regulator. An external decoupling capacitor is required at this pin. This pin should not be used to power any external circuits.	PE0	60	GPIO (5V)
PE1	61	GPIO (5V)	PE2	62	GPIO
PE3	63	GPIO	PE4	64	GPIO
PE5	65	GPIO	PE6	66	GPIO
PE7	67	GPIO	PC8	68	GPIO (5V)
PC9	69	GPIO (5V)	PC10	70	GPIO (5V)
PC11	71	GPIO (5V)	PC12	72	GPIO (5V)
PC13	73	GPIO (5V)	PC14	74	GPIO (5V)

Pin Name	Pin(s)	Description	Pin Name	Pin(s)	Description
PC15	75	GPIO (5V)	PF0	76	GPIO (5V)
PF1	77	GPIO (5V)	PF2	78	GPIO
PF3	79	GPIO	PF4	80	GPIO
PF5	81	GPIO	PF6	84	GPIO
PF7	85	GPIO	PF8	86	GPIO
PF9	87	GPIO	PD9	88	GPIO
PD10	89	GPIO	PD11	90	GPIO
PD12	91	GPIO	PE8	92	GPIO
PE9	93	GPIO	PE10	94	GPIO
PE11	95	GPIO	PE12	96	GPIO
PE13	97	GPIO	PE14	98	GPIO
PE15	99	GPIO	PA15	100	GPIO

Note:

1. GPIO with 5V tolerance are indicated by (5V).

5.12 EFM32GG12B8xx in QFP64 Device Pinout



Figure 5.12. EFM32GG12B8xx in QFP64 Device Pinout

The following table provides package pin connections and general descriptions of pin functionality. For detailed information on the supported features for each GPIO pin, see [5.20 GPIO Functionality Table](#) or [5.21 Alternate Functionality Overview](#).

Table 5.12. EFM32GG12B8xx in QFP64 Device Pinout

Pin Name	Pin(s)	Description	Pin Name	Pin(s)	Description
PA0	1	GPIO	PA1	2	GPIO
PA2	3	GPIO	PA3	4	GPIO
PA4	5	GPIO	PA5	6	GPIO
IOVDD0	7 27 55	Digital IO power supply 0.	VSS	8 23 56	Ground
PB3	9	GPIO	PB4	10	GPIO
PB5	11	GPIO	PB6	12	GPIO

Pin Name	Pin(s)	Description	Pin Name	Pin(s)	Description
PC4	13	GPIO	PC5	14	GPIO
PB7	15	GPIO	PB8	16	GPIO
PA8	17	GPIO	PA12	18	GPIO (5V)
PA14	19	GPIO	RESETn	20	Reset input, active low. This pin is internally pulled up to AVDD. To apply an external reset source to this pin, it is required to only drive this pin low during reset, and let the internal pull-up ensure that reset is released.
PB11	21	GPIO	PB12	22	GPIO
AVDD	24	Analog power supply.	PB13	25	GPIO
PB14	26	GPIO	PD0	28	GPIO (5V)
PD1	29	GPIO	PD2	30	GPIO (5V)
PD3	31	GPIO	PD4	32	GPIO
PD5	33	GPIO	PD6	34	GPIO
PD8	35	GPIO	VREGVSS	36	Voltage regulator VSS
VREGSW	37	DCDC regulator switching node	VREGVDD	38	Voltage regulator VDD input
DVDD	39	Digital power supply.	DECOUPLE	40	Decouple output for on-chip voltage regulator. An external decoupling capacitor is required at this pin. This pin should not be used to power any external circuits.
PE4	41	GPIO	PE5	42	GPIO
PE6	43	GPIO	PE7	44	GPIO
VREGI	45	Input to 5 V regulator.	VREGO	46	Decoupling for 5 V regulator and regulator output. Power for USB PHY in USB-enabled OPNs
PF10	47	GPIO (5V)	PF11	48	GPIO (5V)
PF0	49	GPIO (5V)	PF1	50	GPIO (5V)
PF2	51	GPIO	VBUS	52	USB VBUS signal and auxiliary input to 5 V regulator.
PF12	53	GPIO (5V)	PF5	54	GPIO
PE8	57	GPIO	PE9	58	GPIO
PE10	59	GPIO	PE11	60	GPIO
PE12	61	GPIO	PE13	62	GPIO
PE14	63	GPIO	PE15	64	GPIO

Note:

1. GPIO with 5V tolerance are indicated by (5V).

5.13 EFM32GG12B5xx in QFP64 Device Pinout



Figure 5.13. EFM32GG12B5xx in QFP64 Device Pinout

The following table provides package pin connections and general descriptions of pin functionality. For detailed information on the supported features for each GPIO pin, see [5.20 GPIO Functionality Table](#) or [5.21 Alternate Functionality Overview](#).

Table 5.13. EFM32GG12B5xx in QFP64 Device Pinout

Pin Name	Pin(s)	Description	Pin Name	Pin(s)	Description
PA0	1	GPIO	PA1	2	GPIO
PA2	3	GPIO	PA3	4	GPIO
PA4	5	GPIO	PA5	6	GPIO
IOVDD0	7 27 55	Digital IO power supply 0.	VSS	8 23 56	Ground
PB3	9	GPIO	PB4	10	GPIO
PB5	11	GPIO	PB6	12	GPIO

Pin Name	Pin(s)	Description	Pin Name	Pin(s)	Description
PC4	13	GPIO	PC5	14	GPIO
PB7	15	GPIO	PB8	16	GPIO
PA8	17	GPIO	PA12	18	GPIO (5V)
PA14	19	GPIO	RESETn	20	Reset input, active low. This pin is internally pulled up to AVDD. To apply an external reset source to this pin, it is required to only drive this pin low during reset, and let the internal pull-up ensure that reset is released.
PB11	21	GPIO	PB12	22	GPIO
AVDD	24	Analog power supply.	PB13	25	GPIO
PB14	26	GPIO	PD0	28	GPIO (5V)
PD1	29	GPIO	PD2	30	GPIO (5V)
PD3	31	GPIO	PD4	32	GPIO
PD5	33	GPIO	PD6	34	GPIO
PD7	35	GPIO	PD8	36	GPIO
PC7	37	GPIO	VREGVSS	38	Voltage regulator VSS
VREGSW	39	DCDC regulator switching node	VREGVDD	40	Voltage regulator VDD input
DVDD	41	Digital power supply.	DECOUPLE	42	Decouple output for on-chip voltage regulator. An external decoupling capacitor is required at this pin. This pin should not be used to power any external circuits.
PE4	43	GPIO	PE5	44	GPIO
PE6	45	GPIO	PE7	46	GPIO
PC12	47	GPIO (5V)	PC13	48	GPIO (5V)
PF0	49	GPIO (5V)	PF1	50	GPIO (5V)
PF2	51	GPIO	PF3	52	GPIO
PF4	53	GPIO	PF5	54	GPIO
PE8	57	GPIO	PE9	58	GPIO
PE10	59	GPIO	PE11	60	GPIO
PE12	61	GPIO	PE13	62	GPIO
PE14	63	GPIO	PE15	64	GPIO

Note:

1. GPIO with 5V tolerance are indicated by (5V).

5.14 EFM32GG12B4xx in QFP64 Device Pinout



Figure 5.14. EFM32GG12B4xx in QFP64 Device Pinout

The following table provides package pin connections and general descriptions of pin functionality. For detailed information on the supported features for each GPIO pin, see [5.20 GPIO Functionality Table](#) or [5.21 Alternate Functionality Overview](#).

Table 5.14. EFM32GG12B4xx in QFP64 Device Pinout

Pin Name	Pin(s)	Description	Pin Name	Pin(s)	Description
PA0	1	GPIO	PA1	2	GPIO
PA2	3	GPIO	PA3	4	GPIO
PA4	5	GPIO	PA5	6	GPIO
IOVDD0	7 26 55	Digital IO power supply 0.	VSS	8 22 56	Ground
PB3	9	GPIO	PB4	10	GPIO
PB5	11	GPIO	PB6	12	GPIO

Pin Name	Pin(s)	Description	Pin Name	Pin(s)	Description
PC4	13	GPIO	PC5	14	GPIO
PB7	15	GPIO	PB8	16	GPIO
PA12	17	GPIO (5V)	PA13	18	GPIO (5V)
PA14	19	GPIO	RESETn	20	Reset input, active low. This pin is internally pulled up to AVDD. To apply an external reset source to this pin, it is required to only drive this pin low during reset, and let the internal pull-up ensure that reset is released.
PB11	21	GPIO	AVDD	23 27	Analog power supply.
PB13	24	GPIO	PB14	25	GPIO
PD0	28	GPIO (5V)	PD1	29	GPIO
PD2	30	GPIO (5V)	PD3	31	GPIO
PD4	32	GPIO	PD5	33	GPIO
PD6	34	GPIO	PD7	35	GPIO
PD8	36	GPIO	PC6	37	GPIO
PC7	38	GPIO	DVDD	39	Digital power supply.
DECOUPLE	40	Decouple output for on-chip voltage regulator. An external decoupling capacitor is required at this pin. This pin should not be used to power any external circuits.	PE4	41	GPIO
PE5	42	GPIO	PE6	43	GPIO
PE7	44	GPIO	VREGI	45	Input to 5 V regulator.
VREGO	46	Decoupling for 5 V regulator and regulator output. Power for USB PHY in USB-enabled OPNs	PF10	47	GPIO (5V)
PF11	48	GPIO (5V)	PF0	49	GPIO (5V)
PF1	50	GPIO (5V)	PF2	51	GPIO
VBUS	52	USB VBUS signal and auxiliary input to 5 V regulator.	PF12	53	GPIO (5V)
PF5	54	GPIO	PE8	57	GPIO
PE9	58	GPIO	PE10	59	GPIO
PE11	60	GPIO	PE12	61	GPIO
PE13	62	GPIO	PE14	63	GPIO
PE15	64	GPIO			

Note:

1. GPIO with 5V tolerance are indicated by (5V).

5.15 EFM32GG12B1xx in QFP64 Device Pinout



Figure 5.15. EFM32GG12B1xx in QFP64 Device Pinout

The following table provides package pin connections and general descriptions of pin functionality. For detailed information on the supported features for each GPIO pin, see [5.20 GPIO Functionality Table](#) or [5.21 Alternate Functionality Overview](#).

Table 5.15. EFM32GG12B1xx in QFP64 Device Pinout

Pin Name	Pin(s)	Description	Pin Name	Pin(s)	Description
PA0	1	GPIO	PA1	2	GPIO
PA2	3	GPIO	PA3	4	GPIO
PA4	5	GPIO	PA5	6	GPIO
IOVDD0	7 26 55	Digital IO power supply 0.	VSS	8 22 56	Ground
PC0	9	GPIO (5V)	PC1	10	GPIO (5V)
PC2	11	GPIO (5V)	PC3	12	GPIO (5V)

Pin Name	Pin(s)	Description	Pin Name	Pin(s)	Description
PC4	13	GPIO	PC5	14	GPIO
PB7	15	GPIO	PB8	16	GPIO
PA8	17	GPIO	PA9	18	GPIO
PA10	19	GPIO	RESETn	20	Reset input, active low. This pin is internally pulled up to AVDD. To apply an external reset source to this pin, it is required to only drive this pin low during reset, and let the internal pull-up ensure that reset is released.
PB11	21	GPIO	AVDD	23 27	Analog power supply.
PB13	24	GPIO	PB14	25	GPIO
PD0	28	GPIO (5V)	PD1	29	GPIO
PD2	30	GPIO (5V)	PD3	31	GPIO
PD4	32	GPIO	PD5	33	GPIO
PD6	34	GPIO	PD7	35	GPIO
PD8	36	GPIO	PC6	37	GPIO
PC7	38	GPIO	DVDD	39	Digital power supply.
DECOUPLE	40	Decouple output for on-chip voltage regulator. An external decoupling capacitor is required at this pin. This pin should not be used to power any external circuits.	PC8	41	GPIO (5V)
PC9	42	GPIO (5V)	PC10	43	GPIO (5V)
PC11	44	GPIO (5V)	PC12	45	GPIO (5V)
PC13	46	GPIO (5V)	PC14	47	GPIO (5V)
PC15	48	GPIO (5V)	PF0	49	GPIO (5V)
PF1	50	GPIO (5V)	PF2	51	GPIO
PF3	52	GPIO	PF4	53	GPIO
PF5	54	GPIO	PE8	57	GPIO
PE9	58	GPIO	PE10	59	GPIO
PE11	60	GPIO	PE12	61	GPIO
PE13	62	GPIO	PE14	63	GPIO
PE15	64	GPIO			

Note:

1. GPIO with 5V tolerance are indicated by (5V).

5.16 EFM32GG12B8xx in QFN64 Device Pinout



Figure 5.16. EFM32GG12B8xx in QFN64 Device Pinout

The following table provides package pin connections and general descriptions of pin functionality. For detailed information on the supported features for each GPIO pin, see [5.20 GPIO Functionality Table](#) or [5.21 Alternate Functionality Overview](#).

Table 5.16. EFM32GG12B8xx in QFN64 Device Pinout

Pin Name	Pin(s)	Description	Pin Name	Pin(s)	Description
VSS	0	Ground	PA0	1	GPIO
PA1	2	GPIO	PA2	3	GPIO
PA3	4	GPIO	PA4	5	GPIO
PA5	6	GPIO	PA6	7	GPIO
IOVDD0	8 27 55	Digital IO power supply 0.	PB3	9	GPIO
PB4	10	GPIO	PB5	11	GPIO

Pin Name	Pin(s)	Description	Pin Name	Pin(s)	Description
PB6	12	GPIO	PC4	13	GPIO
PC5	14	GPIO	PB7	15	GPIO
PB8	16	GPIO	PA8	17	GPIO
PA12	18	GPIO (5V)	PA13	19	GPIO (5V)
PA14	20	GPIO	RESETn	21	Reset input, active low. This pin is internally pulled up to AVDD. To apply an external reset source to this pin, it is required to only drive this pin low during reset, and let the internal pull-up ensure that reset is released.
PB11	22	GPIO	PB12	23	GPIO
AVDD	24	Analog power supply.	PB13	25	GPIO
PB14	26	GPIO	PD0	28	GPIO (5V)
PD1	29	GPIO	PD2	30	GPIO (5V)
PD3	31	GPIO	PD4	32	GPIO
PD5	33	GPIO	PD6	34	GPIO
PD8	35	GPIO	VREGVSS	36	Voltage regulator VSS
VREGSW	37	DCDC regulator switching node	VREGVDD	38	Voltage regulator VDD input
DVDD	39	Digital power supply.	DECOUPLE	40	Decouple output for on-chip voltage regulator. An external decoupling capacitor is required at this pin. This pin should not be used to power any external circuits.
PE4	41	GPIO	PE5	42	GPIO
PE6	43	GPIO	PE7	44	GPIO
VREGI	45	Input to 5 V regulator.	VREGO	46	Decoupling for 5 V regulator and regulator output. Power for USB PHY in USB-enabled OPNs
PF10	47	GPIO (5V)	PF11	48	GPIO (5V)
PF0	49	GPIO (5V)	PF1	50	GPIO (5V)
PF2	51	GPIO	VBUS	52	USB VBUS signal and auxiliary input to 5 V regulator.
PF12	53	GPIO (5V)	PF5	54	GPIO
PE8	56	GPIO	PE9	57	GPIO
PE10	58	GPIO	PE11	59	GPIO
PE12	60	GPIO	PE13	61	GPIO
PE14	62	GPIO	PE15	63	GPIO
PA15	64	GPIO			

Note:

1. GPIO with 5V tolerance are indicated by (5V).

5.17 EFM32GG12B5xx in QFN64 Device Pinout



Figure 5.17. EFM32GG12B5xx in QFN64 Device Pinout

The following table provides package pin connections and general descriptions of pin functionality. For detailed information on the supported features for each GPIO pin, see [5.20 GPIO Functionality Table](#) or [5.21 Alternate Functionality Overview](#).

Table 5.17. EFM32GG12B5xx in QFN64 Device Pinout

Pin Name	Pin(s)	Description	Pin Name	Pin(s)	Description
VSS	0	Ground	PA0	1	GPIO
PA1	2	GPIO	PA2	3	GPIO
PA3	4	GPIO	PA4	5	GPIO
PA5	6	GPIO	PA6	7	GPIO
IOVDD0	8 27 55	Digital IO power supply 0.	PB3	9	GPIO
PB4	10	GPIO	PB5	11	GPIO

Pin Name	Pin(s)	Description	Pin Name	Pin(s)	Description
PB6	12	GPIO	PC4	13	GPIO
PC5	14	GPIO	PB7	15	GPIO
PB8	16	GPIO	PA8	17	GPIO
PA12	18	GPIO (5V)	PA13	19	GPIO (5V)
PA14	20	GPIO	RESETn	21	Reset input, active low. This pin is internally pulled up to AVDD. To apply an external reset source to this pin, it is required to only drive this pin low during reset, and let the internal pull-up ensure that reset is released.
PB11	22	GPIO	PB12	23	GPIO
AVDD	24	Analog power supply.	PB13	25	GPIO
PB14	26	GPIO	PD0	28	GPIO (5V)
PD1	29	GPIO	PD2	30	GPIO (5V)
PD3	31	GPIO	PD4	32	GPIO
PD5	33	GPIO	PD6	34	GPIO
PD7	35	GPIO	PD8	36	GPIO
PC7	37	GPIO	VREGVSS	38	Voltage regulator VSS
VREGSW	39	DCDC regulator switching node	VREGVDD	40	Voltage regulator VDD input
DVDD	41	Digital power supply.	DECOUPLE	42	Decouple output for on-chip voltage regulator. An external decoupling capacitor is required at this pin. This pin should not be used to power any external circuits.
PE4	43	GPIO	PE5	44	GPIO
PE6	45	GPIO	PE7	46	GPIO
PC12	47	GPIO (5V)	PC13	48	GPIO (5V)
PF0	49	GPIO (5V)	PF1	50	GPIO (5V)
PF2	51	GPIO	PF3	52	GPIO
PF4	53	GPIO	PF5	54	GPIO
PE8	56	GPIO	PE9	57	GPIO
PE10	58	GPIO	PE11	59	GPIO
PE12	60	GPIO	PE13	61	GPIO
PE14	62	GPIO	PE15	63	GPIO
PA15	64	GPIO			

Note:

1. GPIO with 5V tolerance are indicated by (5V).

5.18 EFM32GG12B4xx in QFN64 Device Pinout



Figure 5.18. EFM32GG12B4xx in QFN64 Device Pinout

The following table provides package pin connections and general descriptions of pin functionality. For detailed information on the supported features for each GPIO pin, see [5.20 GPIO Functionality Table](#) or [5.21 Alternate Functionality Overview](#).

Table 5.18. EFM32GG12B4xx in QFN64 Device Pinout

Pin Name	Pin(s)	Description	Pin Name	Pin(s)	Description
VSS	0	Ground	PA0	1	GPIO
PA1	2	GPIO	PA2	3	GPIO
PA3	4	GPIO	PA4	5	GPIO
PA5	6	GPIO	PA6	7	GPIO
IOVDD0	8 26 55	Digital IO power supply 0.	PB3	9	GPIO
PB4	10	GPIO	PB5	11	GPIO

Pin Name	Pin(s)	Description	Pin Name	Pin(s)	Description
PB6	12	GPIO	PC4	13	GPIO
PC5	14	GPIO	PB7	15	GPIO
PB8	16	GPIO	PA12	17	GPIO (5V)
PA13	18	GPIO (5V)	PA14	19	GPIO
RESETn	20	Reset input, active low. This pin is internally pulled up to AVDD. To apply an external reset source to this pin, it is required to only drive this pin low during reset, and let the internal pull-up ensure that reset is released.	PB11	21	GPIO
PB12	22	GPIO	AVDD	23 27	Analog power supply.
PB13	24	GPIO	PB14	25	GPIO
PD0	28	GPIO (5V)	PD1	29	GPIO
PD2	30	GPIO (5V)	PD3	31	GPIO
PD4	32	GPIO	PD5	33	GPIO
PD6	34	GPIO	PD7	35	GPIO
PD8	36	GPIO	PC6	37	GPIO
PC7	38	GPIO	DVDD	39	Digital power supply.
DECOUPLE	40	Decouple output for on-chip voltage regulator. An external decoupling capacitor is required at this pin. This pin should not be used to power any external circuits.	PE4	41	GPIO
PE5	42	GPIO	PE6	43	GPIO
PE7	44	GPIO	VREGI	45	Input to 5 V regulator.
VREGO	46	Decoupling for 5 V regulator and regulator output. Power for USB PHY in USB-enabled OPNs	PF10	47	GPIO (5V)
PF11	48	GPIO (5V)	PF0	49	GPIO (5V)
PF1	50	GPIO (5V)	PF2	51	GPIO
VBUS	52	USB VBUS signal and auxiliary input to 5 V regulator.	PF12	53	GPIO (5V)
PF5	54	GPIO	PE8	56	GPIO
PE9	57	GPIO	PE10	58	GPIO
PE11	59	GPIO	PE12	60	GPIO
PE13	61	GPIO	PE14	62	GPIO
PE15	63	GPIO	PA15	64	GPIO

Note:

1. GPIO with 5V tolerance are indicated by (5V).

5.19 EFM32GG12B1xx in QFN64 Device Pinout



Figure 5.19. EFM32GG12B1xx in QFN64 Device Pinout

The following table provides package pin connections and general descriptions of pin functionality. For detailed information on the supported features for each GPIO pin, see [5.20 GPIO Functionality Table](#) or [5.21 Alternate Functionality Overview](#).

Table 5.19. EFM32GG12B1xx in QFN64 Device Pinout

Pin Name	Pin(s)	Description	Pin Name	Pin(s)	Description
VSS	0	Ground	PA0	1	GPIO
PA1	2	GPIO	PA2	3	GPIO
PA3	4	GPIO	PA4	5	GPIO
PA5	6	GPIO	PA6	7	GPIO
IOVDD0	8 26 55	Digital IO power supply 0.	PC0	9	GPIO (5V)
PC1	10	GPIO (5V)	PC2	11	GPIO (5V)

Pin Name	Pin(s)	Description	Pin Name	Pin(s)	Description
PC3	12	GPIO (5V)	PC4	13	GPIO
PC5	14	GPIO	PB7	15	GPIO
PB8	16	GPIO	PA8	17	GPIO
PA9	18	GPIO	PA10	19	GPIO
RESETn	20	Reset input, active low. This pin is internally pulled up to AVDD. To apply an external reset source to this pin, it is required to only drive this pin low during reset, and let the internal pull-up ensure that reset is released.	PB11	21	GPIO
PB12	22	GPIO	AVDD	23 27	Analog power supply.
PB13	24	GPIO	PB14	25	GPIO
PD0	28	GPIO (5V)	PD1	29	GPIO
PD2	30	GPIO (5V)	PD3	31	GPIO
PD4	32	GPIO	PD5	33	GPIO
PD6	34	GPIO	PD7	35	GPIO
PD8	36	GPIO	PC6	37	GPIO
PC7	38	GPIO	DVDD	39	Digital power supply.
DECOUPLE	40	Decouple output for on-chip voltage regulator. An external decoupling capacitor is required at this pin. This pin should not be used to power any external circuits.	PC8	41	GPIO (5V)
PC9	42	GPIO (5V)	PC10	43	GPIO (5V)
PC11	44	GPIO (5V)	PC12	45	GPIO (5V)
PC13	46	GPIO (5V)	PC14	47	GPIO (5V)
PC15	48	GPIO (5V)	PF0	49	GPIO (5V)
PF1	50	GPIO (5V)	PF2	51	GPIO
PF3	52	GPIO	PF4	53	GPIO
PF5	54	GPIO	PE8	56	GPIO
PE9	57	GPIO	PE10	58	GPIO
PE11	59	GPIO	PE12	60	GPIO
PE13	61	GPIO	PE14	62	GPIO
PE15	63	GPIO	PA15	64	GPIO

Note:

1. GPIO with 5V tolerance are indicated by (5V).

5.20 GPIO Functionality Table

A wide selection of alternate functionality is available for multiplexing to various pins. The following table shows the name of each GPIO pin, followed by the functionality available on that pin. Refer to [5.21 Alternate Functionality Overview](#) for a list of GPIO locations available for each function.

Table 5.20. GPIO Functionality Table

GPIO Name	Pin Alternate Functionality / Description				
	Analog	EBI	Timers	Communication	Other
PA0	BUSBY BUSAX LCD_SEG13	EBI_AD09 #0 EBI_CSTFT #3	TIM0_CC0 #0 TIM0_CC1 #7 TIM3_CC0 #4 PCNT0_S0IN #4	SDIO_DAT0 #1 US1_RX #5 US3_TX #0 QSPI0_CS0 #1 LEU0_RX #4 I2C0_SDA #0	PDM_CLK #0 CMU_CLK2 #0 PRS_CH0 #0 PRS_CH3 #3 GPIO_EM4WU0
PA1	BUSAY BUSBX LCD_SEG14	EBI_AD10 #0 EBI_DCLK #3	TIM0_CC0 #7 TIM0_CC1 #0 TIM3_CC1 #4 PCNT0_S1IN #4	SDIO_DAT1 #1 US3_RX #0 QSPI0_CS1 #1 I2C0_SCL #0	PDM_DAT0 #0 CMU_CLK1 #0 PRS_CH1 #0
PA2	BUSBY BUSAX LCD_SEG15	EBI_AD11 #0 EBI_DTEN #3	TIM0_CC2 #0 TIM3_CC2 #4	SDIO_DAT2 #1 US1_RX #6 US3_CLK #0 QSPI0_DQ0 #1	PDM_DAT1 #0 CMU_CLK0 #0 PRS_CH8 #1 ETM_TD0 #3
PA3	BUSAY BUSBX LCD_SEG16	EBI_AD12 #0 EBI_VSNC #3	TIM0_CDTI0 #0 TIM3_CC0 #5	SDIO_DAT3 #1 US3_CS #0 U0_TX #2 QSPI0_DQ1 #1	CMU_CLK2 #1 CMU_CLKI0 #1 PDM_DAT2 #0 CMU_CLK2 #4 LES_ALTEX2 PRS_CH9 #1 ETM_TD1 #3
PA4	BUSBY BUSAX LCD_SEG17	EBI_AD13 #0 EBI_HSNC #3	TIM0_CDTI1 #0 TIM3_CC1 #5	SDIO_DAT4 #1 US3_CTS #0 U0_RX #2 QSPI0_DQ2 #1	PDM_DAT3 #0 LES_ALTEX3 ETM_TD2 #3
PA5	BUSAY BUSBX LCD_SEG18	EBI_AD14 #0	TIM0_CDTI2 #0 TIM3_CC2 #5 PCNT1_S0IN #0	SDIO_DAT5 #1 US3_RTS #0 U0_CTS #2 QSPI0_DQ3 #1 LEU1_TX #1	LES_ALTEX4 ACMP1_O #7 ETM_TD3 #3

GPIO Name	Pin Alternate Functionality / Description				
	Analog	EBI	Timers	Communication	Other
PA6	BUSBY BUSAX LCD_SEG19	EBI_AD15 #0	TIM3_CC0 #6 WTIM0_CC0 #1 LETIM1_OUT1 #0 PCNT1_S1IN #0	SDIO_CD #2 U0_RTS #2 LEU1_RX #1	PRS_CH6 #0 ACMP0_O #4 ETM_TCLK #3 GPIO_EM4WU1
PA7	BUSAY BUSBX LCD_SEG35	EBI_AD13 #1 EBI_A01 #3 EBI_CSTFT #0	TIM0_CC2 #5 LETIM1_OUT0 #0 PCNT1_S0IN #4	US2_TX #2 US4_CTS #0	PRS_CH7 #1
PA8	BUSBY BUSAX LCD_SEG36	EBI_AD14 #1 EBI_A02 #3 EBI_DCLK #0	TIM2_CC0 #0 TIM0_CC0 #6 LETIM0_OUT0 #6 PCNT1_S1IN #4	US2_RX #2 US4_RTS #0	PRS_CH8 #0
PA9	BUSAY BUSBX LCD_SEG37	EBI_AD15 #1 EBI_A03 #3 EBI_DTEN #0	TIM2_CC1 #0 TIM0_CC1 #6 LETIM0_OUT1 #6	US2_CLK #2	PRS_CH9 #0
PA10	BUSBY BUSAX LCD_SEG38	EBI_CS0 #1 EBI_A04 #3 EBI_VSNC #0	TIM2_CC2 #0 TIM0_CC2 #6	US2_CS #2	PRS_CH10 #0
PA11	BUSAY BUSBX LCD_SEG39	EBI_CS1 #1 EBI_A05 #3 EBI_HSNC #0	LETIM1_OUT0 #1	US2_CTS #2	PRS_CH11 #0
PA12	BUSBY BUSAX	EBI_CS2 #1 EBI_REn #2 EBI_A00 #0 EBI_A06 #3	TIM2_CC0 #1 WTIM0_CDT10 #2 LETIM1_OUT0 #2 PCNT1_S0IN #5	CAN1_RX #5 US0_CLK #5 US2_RTS #2	CMU_CLK0 #5 PRS_CH12 #0 ACMP1_O #3
PA13	BUSAY BUSBX	EBI_WEn #1 EBI_NANDWEn #2 EBI_A01 #0 EBI_A07 #3	TIM0_CC2 #7 TIM2_CC1 #1 WTIM0_CDT11 #2 LETIM1_OUT1 #1 PCNT1_S1IN #5	CAN1_TX #5 US0_CS #5 US2_TX #3	PDM_DAT3 #3 PRS_CH13 #0
PA14	BUSBY BUSAX LCD_BEXT	EBI_REn #1 EBI_A02 #0 EBI_A08 #3	TIM2_CC2 #1 WTIM0_CDT12 #2 LETIM1_OUT1 #2	US1_TX #6 US2_RX #3 US3_RTS #2	PRS_CH14 #0 ACMP1_O #4
PA15	BUSAY BUSBX LCD_SEG12	EBI_AD08 #0	TIM3_CC2 #0	US2_CLK #3	PRS_CH15 #0

GPIO Name	Pin Alternate Functionality / Description				
	Analog	EBI	Timers	Communication	Other
PB0	BUSBY BUSAX LCD_SEG32	EBI_AD00 #1 EBI_CS0 #3 EBI_A16 #0	TIM2_CDTI0 #0 TIM1_CC0 #2 TIM3_CC2 #7 WTIM0_CC0 #5 PCNT0_S0IN #5 PCNT1_S1IN #2	LEU1_TX #3	PRS_CH4 #1 ACMP0_O #5
PB1	BUSAY BUSBX LCD_SEG33	EBI_AD01 #1 EBI_CS1 #3 EBI_A17 #0	TIM2_CDTI1 #0 TIM1_CC1 #2 WTIM0_CC1 #5 LETIM1_OUT1 #5 PCNT0_S1IN #5	LEU1_RX #3	PRS_CH5 #1
PB2	BUSBY BUSAX LCD_SEG34	EBI_AD02 #1 EBI_CS2 #3 EBI_A18 #0	TIM2_CDTI2 #0 TIM1_CC2 #2 WTIM0_CC2 #5 LETIM1_OUT0 #5	US1_CS #6	ACMP0_O #6
PB3	BUSAY BUSBX LCD_SEG20 / LCD_COM4	EBI_AD03 #1 EBI_CS3 #3 EBI_A19 #0	TIM1_CC3 #2 WTIM0_CC0 #6 PCNT1_S0IN #1	SDIO_DAT6 #1 US2_TX #1 US3_TX #2 QSPI0_DQ4 #1	ACMP0_O #7
PB4	BUSBY BUSAX LCD_SEG21 / LCD_COM5	EBI_AD04 #1 EBI_ARDY #3 EBI_A20 #0	WTIM0_CC1 #6 PCNT1_S1IN #1	SDIO_DAT7 #1 US2_RX #1 QSPI0_DQ5 #1 LEU1_TX #4	
PB5	BUSAY BUSBX LCD_SEG22 / LCD_COM6	EBI_AD05 #1 EBI_ALE #3 EBI_A21 #0	WTIM0_CC2 #6 LETIM1_OUT0 #4 PCNT0_S0IN #6	US0_RTS #4 US2_CLK #1 QSPI0_DQ6 #1 LEU1_RX #4	
PB6	BUSBY BUSAX LCD_SEG23 / LCD_COM7	EBI_AD06 #1 EBI_WEn #3 EBI_A22 #0	TIM0_CC0 #3 TIM2_CC0 #4 LETIM1_OUT1 #4 PCNT0_S1IN #6	US0_CTS #4 US2_CS #1 QSPI0_DQ7 #1	PRS_CH12 #1
PB7	LFXTAL_P		TIM0_CDTI0 #4 TIM1_CC0 #3	US0_TX #4 US1_CLK #0 US3_RX #2 US4_TX #0 U0_CTS #4	

GPIO Name	Pin Alternate Functionality / Description				
	Analog	EBI	Timers	Communication	Other
PB8	LFXTAL_N		TIM0_CDTI1 #4 TIM1_CC1 #3	US0_RX #4 US1_CS #0 US4_RX #0 U0_RTS #4	CMU_CLKI0 #2
PB9	BUSAY BUSBX	EBI_ALE #1 EBI_NANDREn #2 EBI_A00 #1 EBI_A03 #0 EBI_A09 #3	LETIM0_OUT0 #7	SDIO_WP #3 CAN0_RX #3 US1_CTS #0 U1_TX #2	PDM_DAT2 #3 PRS_CH13 #1 ACMP1_O #5
PB10	BUSBY BUSAX	EBI_BL0 #2 EBI_A01 #1 EBI_A04 #0 EBI_A10 #3	LETIM0_OUT1 #7	SDIO_CD #3 CAN0_TX #3 US1_RTS #0 US2_CTS #3 U1_RX #2	PDM_DAT1 #3 PRS_CH9 #2 ACMP1_O #6
PB11	BUSAY BUSBX VDAC0_OUT0 / OPA0_OUT IDAC0_OUT	EBI_BL1 #2 EBI_A02 #1 EBI_A11 #3	TIM0_CDTI2 #4 TIM1_CC2 #3 LETIM0_OUT0 #1 PCNT0_S1IN #7 PCNT1_S0IN #6	US0_CTS #5 US1_CLK #5 US2_CS #3 U1_CTS #2 I2C1_SDA #1	CMU_CLK1 #5 CMU_CLKI0 #7 PDM_DAT0 #3 ACMP0_O #3 GPIO_EM4WU7
PB12	BUSBY BUSAX VDAC0_OUT1 / OPA1_OUT	EBI_A03 #1 EBI_A12 #3	TIM1_CC3 #3 LETIM0_OUT1 #1 PCNT0_S0IN #7 PCNT1_S1IN #6	US2_CTS #1 U1_RTS #2 I2C1_SCL #1	PDM_CLK #3
PB13	BUSAY BUSBX HFXTAL_P		WTIM1_CC0 #0 PCNT2_S0IN #2	US0_CLK #4 US1_CTS #5 LEU0_TX #1	CMU_CLKI0 #3 PRS_CH7 #0
PB14	BUSBY BUSAX HFXTAL_N		WTIM1_CC1 #0 PCNT2_S1IN #2	US0_CS #4 US1_RTS #5 LEU0_RX #1	PRS_CH6 #1
PB15	BUSAY BUSBX	EBI_CS3 #1 EBI_ARDY #2	TIM3_CC1 #7	SDIO_WP #2 US2_RTS #1	ETM_TD2 #1

GPIO Name	Pin Alternate Functionality / Description				
	Analog	EBI	Timers	Communication	Other
PC0	VDAC0_OUT0ALT / OPA0_OUTALT #0 BUSACMP0Y BUSACMP0X	EBI_AD07 #1 EBI_CS0 #2 EBI_REn #3 EBI_A23 #0	TIM0_CC1 #3 TIM2_CC1 #4 PCNT0_S0IN #2	CAN0_RX #0 US0_TX #5 US1_TX #0 US1_CS #4 US2_RTS #0 US3_CS #3 I2C0_SDA #4	LES_CH0 PRS_CH2 #0
PC1	VDAC0_OUT0ALT / OPA0_OUTALT #1 BUSACMP0Y BUSACMP0X	EBI_AD08 #1 EBI_CS1 #2 EBI_BL0 #3 EBI_A24 #0	TIM0_CC2 #3 TIM2_CC2 #4 WTIM0_CC0 #7 PCNT0_S1IN #2	CAN0_TX #0 US0_RX #5 US1_TX #4 US1_RX #0 US2_CTS #0 US3_RTS #1 I2C0_SCL #4	LES_CH1 PRS_CH3 #0
PC2	VDAC0_OUT0ALT / OPA0_OUTALT #2 BUSACMP0Y BUSACMP0X	EBI_AD09 #1 EBI_CS2 #2 EBI_NANDWEEn #3 EBI_A25 #0	TIM0_CDTI0 #3 TIM2_CC0 #5 WTIM0_CC1 #7 LETIM1_OUT0 #3	CAN1_RX #0 US1_RX #4 US2_TX #0 QSPIO_RST0 #1	LES_CH2 PRS_CH10 #1
PC3	VDAC0_OUT0ALT / OPA0_OUTALT #3 BUSACMP0Y BUSACMP0X	EBI_AD10 #1 EBI_CS3 #2 EBI_BL1 #3 EBI_NANDREn #0	TIM0_CDTI1 #3 TIM2_CC1 #5 WTIM0_CC2 #7 LETIM1_OUT1 #3	CAN1_TX #0 US1_CLK #4 US2_RX #0 QSPIO_RST1 #1	LES_CH3 PRS_CH11 #1
PC4	BUSACMP0Y BUSACMP0X OPA0_P	EBI_AD11 #1 EBI_ALE #2 EBI_NANDREn #3 EBI_A26 #0	TIM0_CC0 #5 TIM0_CDTI2 #3 TIM2_CC2 #5 LETIM0_OUT0 #3 PCNT1_S0IN #3	SDIO_CD #1 US2_CLK #0 US4_CLK #0 U0_TX #4 U1_CTS #4 I2C1_SDA #0	LES_CH4 GPIO_EM4WU6
PC5	BUSACMP0Y BUSACMP0X OPA0_N	EBI_AD12 #1 EBI_WEn #2 EBI_NANDWEEn #0 EBI_A00 #3	TIM0_CC1 #5 LETIM0_OUT1 #3 PCNT1_S1IN #3	SDIO_WP #1 US2_CS #0 US4_CS #0 U0_RX #4 U1_RTS #4 I2C1_SCL #0	LES_CH5

GPIO Name	Pin Alternate Functionality / Description				
	Analog	EBI	Timers	Communication	Other
PC6	BUSACMP0Y BUSACMP0X OPA3_P	EBI_A05 #0	WTIM1_CC3 #2	US0_RTS #2 US1_CTS #3 LEU1_TX #0 I2C0_SDA #2	LES_CH6 PRS_CH14 #1 ETM_TCLK #2
PC7	BUSACMP0Y BUSACMP0X OPA3_N	EBI_A06 #0 EBI_A13 #1 EBI_A21 #3	WTIM1_CC0 #3	US0_CTS #2 US1_RTS #3 LEU1_RX #0 I2C0_SCL #2	LES_CH7 PRS_CH15 #1 ETM_TD0 #2
PC8	BUSACMP1Y BUSACMP1X	EBI_A15 #0 EBI_A20 #1 EBI_A26 #3	TIM2_CC0 #2	US0_CS #2	LES_CH8 PRS_CH4 #0
PC9	BUSACMP1Y BUSACMP1X	EBI_A21 #1 EBI_A27 #3	TIM2_CC1 #2	CAN1_RX #3 US0_CLK #2	LES_CH9 PRS_CH5 #0 GPIO_EM4WU2
PC10	BUSACMP1Y BUSACMP1X	EBI_A22 #1	TIM2_CC2 #2	CAN1_TX #3 US0_RX #2	LES_CH10
PC11	BUSACMP1Y BUSACMP1X	EBI_ALE #4 EBI_ALE #5 EBI_A23 #1		CAN1_TX #4 US0_TX #2 I2C1_SDA #4	LES_CH11
PC12	VDAC0_OUT1ALT / OPA1_OUTALT #0 BUSACMP1Y BUSACMP1X		TIM1_CC3 #0 PCNT2_S0IN #4	CAN1_RX #4 US0_RTS #3 US1_CTS #4 US2_CTS #4 U0_RTS #3 U1_TX #0	CMU_CLK0 #1 LES_CH12
PC13	VDAC0_OUT1ALT / OPA1_OUTALT #1 BUSACMP1Y BUSACMP1X	EBI_ARDY #4	TIM0_CDTI0 #1 TIM1_CC0 #0 TIM1_CC2 #4 PCNT0_S0IN #0 PCNT2_S1IN #4	US0_CTS #3 US1_RTS #4 US2_RTS #4 U0_CTS #3 U1_RX #0	LES_CH13

GPIO Name	Pin Alternate Functionality / Description				
	Analog	EBI	Timers	Communication	Other
PC14	VDAC0_OUT1ALT / OPA1_OUTALT #2 BUSACMP1Y BUSACMP1X	EBI_NANDWE _n #4	TIM0_CDTI1 #1 TIM1_CC1 #0 TIM1_CC3 #4 LETIM0_OUT0 #5 PCNT0_S1IN #0	US0_CS #3 US1_CS #3 US2_RTS #3 US3_CS #2 U0_TX #3 U1_CTS #0 LEU0_TX #5	LES_CH14 PRS_CH0 #2
PC15	VDAC0_OUT1ALT / OPA1_OUTALT #3 BUSACMP1Y BUSACMP1X	EBI_NANDRE _n #4	TIM0_CDTI2 #1 TIM1_CC2 #0 WTIM0_CC0 #4 LETIM0_OUT1 #5	US0_CLK #3 US1_CLK #3 US3_RTS #3 U0_RX #3 U1_RTS #0 LEU0_RX #5	LES_CH15 PRS_CH1 #2 DBG_SWO #1
PD0	VDAC0_OUT0ALT / OPA0_OUTALT #4 OPA2_OUTALT BUSADC0Y BUSADC0X	EBI_A04 #1 EBI_A13 #3	WTIM1_CC2 #0 PCNT2_S0IN #0	CAN0_RX #2 US1_TX #1 USB_VBUSEN #2	PDM_CLK #4
PD1	VDAC0_OUT1ALT / OPA1_OUTALT #4 BUSADC0Y BUSADC0X OPA3_OUT	EBI_A05 #1 EBI_A14 #3	TIM0_CC0 #2 WTIM1_CC3 #0 PCNT2_S1IN #0	CAN0_TX #2 US1_RX #1	PDM_DAT0 #4 DBG_SWO #2
PD2	BUSADC0Y BUSADC0X	EBI_A06 #1 EBI_A15 #3 EBI_A27 #0	TIM0_CC1 #2 WTIM1_CC0 #1	US1_CLK #1 LEU1_TX #2	PDM_DAT1 #4 DBG_SWO #3
PD3	BUSADC0Y BUSADC0X OPA2_N	EBI_A07 #1 EBI_A16 #3	TIM0_CC2 #2 WTIM1_CC1 #1	CAN1_RX #2 US1_CS #1 LEU1_RX #2	PDM_DAT2 #4 ETM_TD1 #0 ETM_TD1 #2
PD4	BUSADC0Y BUSADC0X OPA2_P	EBI_A08 #1 EBI_A17 #3	WTIM0_CDTI0 #4 WTIM1_CC2 #1	CAN1_TX #2 US1_CTS #1 US3_CLK #2 LEU0_TX #0 I2C1_SDA #3	CMU_CLKI0 #0 PDM_DAT3 #4 PRS_CH10 #2 ETM_TD2 #0 ETM_TD2 #2

GPIO Name	Pin Alternate Functionality / Description				
	Analog	EBI	Timers	Communication	Other
PD5	BUSADC0Y BUSADC0X OPA2_OUT	EBI_A09 #1 EBI_A18 #3	WTIM0_CDTI1 #4 WTIM1_CC3 #1	US1_RTS #1 U0_CTS #5 LEU0_RX #0 I2C1_SCL #3	PRS_CH11 #2 ETM_TD3 #0 ETM_TD3 #2
PD6	BUSADC0Y BUSADC0X ADC0_EXTP VDAC0_EXT ADC1_EXTP OPA1_P	EBI_A10 #1 EBI_A19 #3	TIM1_CC0 #4 WTIM0_CDTI2 #4 WTIM1_CC0 #2 LETIM0_OUT0 #0 PCNT0_S0IN #3	US0_RTS #5 US1_RX #2 US2_CTS #5 US3_CTS #2 U0_RTS #5 I2C0_SDA #1	CMU_CLK2 #2 LES_ALTEX0 PRS_CH5 #2 ACMP0_O #2 ETM_TD0 #0
PD7	BUSADC0Y BUSADC0X ADC0_EXTN ADC1_EXTN OPA1_N	EBI_A11 #1 EBI_A20 #3	TIM1_CC1 #4 WTIM1_CC1 #2 LETIM0_OUT1 #0 PCNT0_S1IN #3	US1_TX #2 US3_CLK #1 U0_TX #6 I2C0_SCL #1	CMU_CLK0 #2 LES_ALTEX1 ACMP1_O #2 ETM_TCLK #0
PD8	BU_VIN	EBI_A12 #1	WTIM1_CC2 #2	US2_RTS #5	CMU_CLK1 #1 PRS_CH12 #2 ACMP2_O #0
PD9	LCD_SEG28	EBI_CS0 #0 EBI_DTEN #1		SDIO_DAT7 #0 QSPI0_DQ0 #0 US4_TX #1	PDM_DAT3 #2
PD10	LCD_SEG29	EBI_CS1 #0 EBI_VSNC #1		SDIO_DAT6 #0 QSPI0_DQ1 #0 US4_RX #1	CMU_CLK2 #5 CMU_CLKI0 #5
PD11	LCD_SEG30	EBI_CS2 #0 EBI_HSNC #1		SDIO_DAT5 #0 QSPI0_DQ2 #0 US4_CLK #1	
PD12	LCD_SEG31	EBI_CS3 #0		SDIO_DAT4 #0 QSPI0_DQ3 #0 US4_CS #1	
PD13		EBI_ARDY #1	TIM2_CDTI0 #1 TIM3_CC1 #6 WTIM0_CC1 #1	US4_CTS #1	ETM_TD1 #1
PD14		EBI_NANDWE _n #1	TIM2_CDTI1 #1 TIM3_CC2 #6 WTIM0_CC2 #1	CAN0_RX #5 US4_RTS #1 I2C0_SDA #3	

GPIO Name	Pin Alternate Functionality / Description				
	Analog	EBI	Timers	Communication	Other
PD15		EBI_NANDREn #1	TIM2_CDTI2 #1 TIM3_CC0 #7 WTIM0_CDTI0 #1 PCNT1_S0IN #2	CAN0_TX #5 I2C0_SCL #3	
PE0	BUSDY BUSCX	EBI_A07 #0	TIM3_CC0 #1 WTIM1_CC1 #3 PCNT0_S0IN #1	CAN0_RX #6 U0_TX #1 I2C1_SDA #2	ACMP2_O #1
PE1	BUSCY BUSDX	EBI_A08 #0	TIM3_CC1 #1 WTIM1_CC2 #3 PCNT0_S1IN #1	CAN0_TX #6 U0_RX #1 I2C1_SCL #2	CMU_CLKI0 #4 ACMP2_O #2
PE2	BU_VOUT	EBI_A09 #0 EBI_A14 #1	TIM3_CC2 #1 WTIM1_CC3 #3	US0_RTS #1 U0_CTS #1 U1_TX #3	ACMP0_O #1
PE3	BU_STAT	EBI_A10 #0 EBI_A15 #1	TIM3_CC0 #2 WTIM1_CC0 #4	US0_CTS #1 U0_RTS #1 U1_RX #3	ACMP1_O #1
PE4	BUSDY BUSCX LCD_COM0	EBI_A11 #0 EBI_A16 #1 EBI_A22 #3	TIM3_CC1 #2 WTIM0_CC0 #0 WTIM1_CC1 #4	US0_CS #1 US1_CS #5 US3_CS #1 U0_RX #6 U1_CTS #3 I2C0_SDA #7 USB_VBUSEN #1	
PE5	BUSCY BUSDX LCD_COM1	EBI_A12 #0 EBI_A17 #1 EBI_A23 #3	TIM3_CC0 #3 TIM3_CC2 #2 WTIM0_CC1 #0 WTIM1_CC2 #4	US0_CLK #1 US1_CLK #6 US3_CTS #1 U1_RTS #3 I2C0_SCL #7	
PE6	BUSDY BUSCX LCD_COM2	EBI_A13 #0 EBI_A18 #1 EBI_A24 #3	TIM3_CC1 #3 WTIM0_CC2 #0 WTIM1_CC3 #4	US0_RX #1 US3_TX #1	PRS_CH6 #2
PE7	BUSCY BUSDX LCD_COM3	EBI_A14 #0 EBI_A19 #1 EBI_A25 #3	TIM3_CC2 #3 WTIM1_CC0 #5	US0_TX #1 US3_RX #1	PRS_CH7 #2

GPIO Name	Pin Alternate Functionality / Description				
	Analog	EBI	Timers	Communication	Other
PE8	BUSDY BUSCX LCD_SEG4	EBI_AD00 #0 EBI_CS0 #4	TIM2_CDTI0 #2 PCNT2_S0IN #1	SDIO_DAT3 #0 QSPIO_DQ4 #0	PDM_CLK #1 PRS_CH3 #1
PE9	BUSCY BUSDX LCD_SEG5	EBI_AD01 #0 EBI_CS1 #4	PCNT2_S1IN #1	SDIO_DAT2 #0 QSPIO_DQ5 #0	PDM_DAT0 #1 PRS_CH8 #2
PE10	BUSDY BUSCX LCD_SEG6	EBI_AD02 #0 EBI_CS2 #4	TIM1_CC0 #1 WTIM0_CDTI0 #0	SDIO_DAT1 #0 QSPIO_DQ6 #0 US0_TX #0	PDM_DAT1 #1 PRS_CH2 #2 GPIO_EM4WU9
PE11	BUSCY BUSDX LCD_SEG7	EBI_AD03 #0 EBI_CS3 #4	TIM1_CC1 #1 WTIM0_CDTI1 #0	SDIO_DAT0 #0 QSPIO_DQ7 #0 US0_RX #0	LES_ALTEX5 PDM_DAT2 #1 PRS_CH3 #2 ETM_TCLK #4
PE12	BUSDY BUSCX LCD_SEG8	EBI_AD04 #0	TIM1_CC2 #1 TIM2_CC1 #3 WTIM0_CDTI2 #0 LETIM0_OUT0 #4	SDIO_CMD #0 US0_RX #3 US0_CLK #0 U1_TX #4 I2C0_SDA #6	CMU_CLK1 #2 CMU_CLKI0 #6 LES_ALTEX6 PDM_DAT3 #1 PRS_CH1 #3 ETM_TD0 #4
PE13	BUSCY BUSDX LCD_SEG9	EBI_AD05 #0	TIM1_CC3 #1 TIM2_CC2 #3 LETIM0_OUT1 #4	SDIO_CLK #0 US0_TX #3 US0_CS #0 U1_RX #4 I2C0_SCL #6	LES_ALTEX7 PRS_CH2 #3 ACMP0_O #0 ETM_TD1 #4 GPIO_EM4WU5
PE14	BUSDY BUSCX LCD_SEG10	EBI_AD06 #0	TIM2_CDTI1 #2 TIM3_CC0 #0	QSPIO_RST0 #0 SDIO_CLK #1 US0_CTS #0 QSPIO_SCLK #1 LEU0_TX #2	PRS_CH13 #2 ETM_TD2 #4
PE15	BUSCY BUSDX LCD_SEG11	EBI_AD07 #0	TIM2_CDTI2 #2 TIM3_CC1 #0	QSPIO_RST1 #0 SDIO_CMD #1 US0_RTS #0 QSPIO_DQS #1 LEU0_RX #2	PRS_CH14 #2 ETM_TD3 #4

GPIO Name	Pin Alternate Functionality / Description				
	Analog	EBI	Timers	Communication	Other
PF0	BUSDY BUSCX	EBI_A24 #1	TIM0_CC0 #4 WTIM0_CC1 #4 LETIM0_OUT0 #2	US2_TX #5 CAN0_RX #1 US1_CLK #2 LEU0_TX #3 I2C0_SDA #5	PRS_CH15 #2 DBG_SWCLKTCK BOOT_TX
PF1	BUSCY BUSDX	EBI_A25 #1	TIM0_CC1 #4 WTIM0_CC2 #4 LETIM0_OUT1 #2	US2_RX #5 CAN1_RX #1 US1_CS #2 U0_TX #5 LEU0_RX #3 I2C0_SCL #5	PRS_CH4 #2 DBG_SWDIOTMS GPIO_EM4WU3 BOOT_RX
PF2	BUSDY BUSCX LCD_SEG0	EBI_ARDY #0 EBI_A26 #1	TIM0_CC2 #4 TIM1_CC0 #5 TIM2_CC0 #3	US2_CLK #5 CAN0_TX #1 US1_TX #5 U0_RX #5 LEU0_TX #4 I2C1_SCL #4	CMU_CLK0 #4 PRS_CH0 #3 ACMP1_O #0 DBG_TDO DBG_SWO #0 GPIO_EM4WU4
PF3	BUSCY BUSDX LCD_SEG1	EBI_ALE #0	TIM0_CDTI0 #2 TIM1_CC1 #5	CAN1_TX #1 US1_CTS #2	CMU_CLK1 #4 PRS_CH0 #1 ETM_TD3 #1
PF4	BUSDY BUSCX LCD_SEG2	EBI_WEn #0 EBI_WEn #5	TIM0_CDTI1 #2 TIM1_CC2 #5	US1_RTS #2	PRS_CH1 #1
PF5	BUSCY BUSDX LCD_SEG3	EBI_REn #0 EBI_REn #5 EBI_A27 #1	TIM0_CDTI2 #2 TIM1_CC3 #6	US2_CS #5 USB_VBUSEN #0	PRS_CH2 #1 DBG_TDI
PF6	BUSDY BUSCX LCD_SEG24	EBI_BL0 #0 EBI_BL0 #4 EBI_BL0 #5 EBI_CSTFT #1	TIM0_CC0 #1	US2_TX #4 QSPIO_SCLK #0 US1_TX #3 U0_TX #0	PDM_CLK #2
PF7	BUSCY BUSDX LCD_SEG25	EBI_BL1 #0 EBI_BL1 #4 EBI_BL1 #5 EBI_DCLK #1	TIM0_CC1 #1	US2_RX #4 QSPIO_CS0 #0 US1_RX #3 U0_RX #0	PDM_DAT0 #2

GPIO Name	Pin Alternate Functionality / Description				
	Analog	EBI	Timers	Communication	Other
PF8	BUSDY BUSCX LCD_SEG26	EBI_WEn #4 EBI_BL0 #1	TIM0_CC2 #1	US2_CLK #4 QSPIO_CS1 #0 SDIO_CD #0 U0_CTS #0 U1_RTS #1	PDM_DAT1 #2 ETM_TCLK #1 GPIO_EM4WU8
PF9	BUSCY BUSDX LCD_SEG27	EBI_REn #4 EBI_BL1 #1		US2_CS #4 QSPIO_DQS #0 SDIO_WP #0 U0_RTS #0 U1_CTS #1	PDM_DAT2 #2 ETM_TD0 #1
PF10	BUSDY BUSCX	EBI_ARDY #5	PCNT2_S0IN #3	U1_TX #1 USB_DM	
PF11	BUSCY BUSDX	EBI_NANDWEn #5	PCNT2_S1IN #3	U1_RX #1 USB_DP	
PF12	BUSDY BUSCX	EBI_NANDREn #5	TIM1_CC3 #5	USB_ID	
PF13	BUSCY BUSDX		TIM1_CC0 #6		
PF14	BUSDY BUSCX		TIM1_CC1 #6		

5.21 Alternate Functionality Overview

A wide selection of alternate functionality is available for multiplexing to various pins. The following table shows the name of the alternate functionality in the first column, followed by columns showing the possible LOCATION bitfield settings and the associated GPIO pin. Refer to [5.20 GPIO Functionality Table](#) for a list of functions available on each GPIO pin.

Note: Some functionality, such as analog interfaces, do not have alternate settings or a LOCATION bitfield. In these cases, the pinout is shown in the column corresponding to LOCATION 0.

Table 5.21. Alternate Functionality Overview

Alternate Functionality	LOCATION		Description
	0 - 3	4 - 7	
ACMP0_O	0: PE13 1: PE2 2: PD6 3: PB11	4: PA6 5: PB0 6: PB2 7: PB3	Analog comparator ACMP0, digital output.
ACMP1_O	0: PF2 1: PE3 2: PD7 3: PA12	4: PA14 5: PB9 6: PB10 7: PA5	Analog comparator ACMP1, digital output.
ACMP2_O	0: PD8 1: PE0 2: PE1		Analog comparator ACMP2, digital output.
ADC0_EXTN	0: PD7		Analog to digital converter ADC0 external reference input negative pin.
ADC0_EXTP	0: PD6		Analog to digital converter ADC0 external reference input positive pin.
ADC1_EXTN	0: PD7		Analog to digital converter ADC1 external reference input negative pin.
ADC1_EXTP	0: PD6		Analog to digital converter ADC1 external reference input positive pin.
BOOT_RX	0: PF1		Bootloader RX.
BOOT_TX	0: PF0		Bootloader TX.
BU_STAT	0: PE3		Backup Power Domain status, whether or not the system is in backup mode.
BU_VIN	0: PD8		Battery input for Backup Power Domain.
BU_VOUT	0: PE2		Power output for Backup Power Domain.
CAN0_RX	0: PC0 1: PF0 2: PD0 3: PB9	5: PD14 6: PE0	CAN0 RX.
CAN0_TX	0: PC1 1: PF2 2: PD1 3: PB10	5: PD15 6: PE1	CAN0 TX.

Alternate	LOCATION		Description
	0 - 3	4 - 7	
CAN1_RX	0: PC2 1: PF1 2: PD3 3: PC9	4: PC12 5: PA12	CAN1 RX.
CAN1_TX	0: PC3 1: PF3 2: PD4 3: PC10	4: PC11 5: PA13	CAN1 TX.
CMU_CLK0	0: PA2 1: PC12 2: PD7	4: PF2 5: PA12	Clock Management Unit, clock output number 0.
CMU_CLK1	0: PA1 1: PD8 2: PE12	4: PF3 5: PB11	Clock Management Unit, clock output number 1.
CMU_CLK2	0: PA0 1: PA3 2: PD6	4: PA3 5: PD10	Clock Management Unit, clock output number 2.
CMU_CLKI0	0: PD4 1: PA3 2: PB8 3: PB13	4: PE1 5: PD10 6: PE12 7: PB11	Clock Management Unit, clock input number 0.
DBG_SWCLKTCK	0: PF0		Debug-interface Serial Wire clock input and JTAG Test Clock. Note that this function is enabled to the pin out of reset, and has a built-in pull down.
DBG_SWDIOTMS	0: PF1		Debug-interface Serial Wire data input / output and JTAG Test Mode Select. Note that this function is enabled to the pin out of reset, and has a built-in pull up.
DBG_SWO	0: PF2 1: PC15 2: PD1 3: PD2		Debug-interface Serial Wire viewer Output. Note that this function is not enabled after reset, and must be enabled by software to be used.
DBG_TDI	0: PF5		Debug-interface JTAG Test Data In. Note that this function becomes available after the first valid JTAG command is received, and has a built-in pull up when JTAG is active.
DBG_TDO	0: PF2		Debug-interface JTAG Test Data Out. Note that this function becomes available after the first valid JTAG command is received.

Alternate	LOCATION		Description
	0 - 3	4 - 7	
EBI_A00	0: PA12 1: PB9 3: PC5		External Bus Interface (EBI) address output pin 00.
EBI_A01	0: PA13 1: PB10 3: PA7		External Bus Interface (EBI) address output pin 01.
EBI_A02	0: PA14 1: PB11 3: PA8		External Bus Interface (EBI) address output pin 02.
EBI_A03	0: PB9 1: PB12 3: PA9		External Bus Interface (EBI) address output pin 03.
EBI_A04	0: PB10 1: PD0 3: PA10		External Bus Interface (EBI) address output pin 04.
EBI_A05	0: PC6 1: PD1 3: PA11		External Bus Interface (EBI) address output pin 05.
EBI_A06	0: PC7 1: PD2 3: PA12		External Bus Interface (EBI) address output pin 06.
EBI_A07	0: PE0 1: PD3 3: PA13		External Bus Interface (EBI) address output pin 07.
EBI_A08	0: PE1 1: PD4 3: PA14		External Bus Interface (EBI) address output pin 08.
EBI_A09	0: PE2 1: PD5 3: PB9		External Bus Interface (EBI) address output pin 09.
EBI_A10	0: PE3 1: PD6 3: PB10		External Bus Interface (EBI) address output pin 10.
EBI_A11	0: PE4 1: PD7 3: PB11		External Bus Interface (EBI) address output pin 11.

Alternate	LOCATION		Description
	0 - 3	4 - 7	
EBI_A12	0: PE5 1: PD8 3: PB12		External Bus Interface (EBI) address output pin 12.
EBI_A13	0: PE6 1: PC7 3: PD0		External Bus Interface (EBI) address output pin 13.
EBI_A14	0: PE7 1: PE2 3: PD1		External Bus Interface (EBI) address output pin 14.
EBI_A15	0: PC8 1: PE3 3: PD2		External Bus Interface (EBI) address output pin 15.
EBI_A16	0: PB0 1: PE4 3: PD3		External Bus Interface (EBI) address output pin 16.
EBI_A17	0: PB1 1: PE5 3: PD4		External Bus Interface (EBI) address output pin 17.
EBI_A18	0: PB2 1: PE6 3: PD5		External Bus Interface (EBI) address output pin 18.
EBI_A19	0: PB3 1: PE7 3: PD6		External Bus Interface (EBI) address output pin 19.
EBI_A20	0: PB4 1: PC8 3: PD7		External Bus Interface (EBI) address output pin 20.
EBI_A21	0: PB5 1: PC9 3: PC7		External Bus Interface (EBI) address output pin 21.
EBI_A22	0: PB6 1: PC10 3: PE4		External Bus Interface (EBI) address output pin 22.
EBI_A23	0: PC0 1: PC11 3: PE5		External Bus Interface (EBI) address output pin 23.

Alternate	LOCATION		Description
	0 - 3	4 - 7	
EBI_A24	0: PC1 1: PF0 3: PE6		External Bus Interface (EBI) address output pin 24.
EBI_A25	0: PC2 1: PF1 3: PE7		External Bus Interface (EBI) address output pin 25.
EBI_A26	0: PC4 1: PF2 3: PC8		External Bus Interface (EBI) address output pin 26.
EBI_A27	0: PD2 1: PF5 3: PC9		External Bus Interface (EBI) address output pin 27.
EBI_AD00	0: PE8 1: PB0		External Bus Interface (EBI) address and data input / output pin 00.
EBI_AD01	0: PE9 1: PB1		External Bus Interface (EBI) address and data input / output pin 01.
EBI_AD02	0: PE10 1: PB2		External Bus Interface (EBI) address and data input / output pin 02.
EBI_AD03	0: PE11 1: PB3		External Bus Interface (EBI) address and data input / output pin 03.
EBI_AD04	0: PE12 1: PB4		External Bus Interface (EBI) address and data input / output pin 04.
EBI_AD05	0: PE13 1: PB5		External Bus Interface (EBI) address and data input / output pin 05.
EBI_AD06	0: PE14 1: PB6		External Bus Interface (EBI) address and data input / output pin 06.
EBI_AD07	0: PE15 1: PC0		External Bus Interface (EBI) address and data input / output pin 07.
EBI_AD08	0: PA15 1: PC1		External Bus Interface (EBI) address and data input / output pin 08.
EBI_AD09	0: PA0 1: PC2		External Bus Interface (EBI) address and data input / output pin 09.
EBI_AD10	0: PA1 1: PC3		External Bus Interface (EBI) address and data input / output pin 10.
EBI_AD11	0: PA2 1: PC4		External Bus Interface (EBI) address and data input / output pin 11.

Alternate	LOCATION		
Functionality	0 - 3	4 - 7	Description
EBI_AD12	0: PA3 1: PC5		External Bus Interface (EBI) address and data input / output pin 12.
EBI_AD13	0: PA4 1: PA7		External Bus Interface (EBI) address and data input / output pin 13.
EBI_AD14	0: PA5 1: PA8		External Bus Interface (EBI) address and data input / output pin 14.
EBI_AD15	0: PA6 1: PA9		External Bus Interface (EBI) address and data input / output pin 15.
EBI_ALE	0: PF3 1: PB9 2: PC4 3: PB5	4: PC11 5: PC11	External Bus Interface (EBI) Address Latch Enable output.
EBI_ARDY	0: PF2 1: PD13 2: PB15 3: PB4	4: PC13 5: PF10	External Bus Interface (EBI) Hardware Ready Control input.
EBI_BL0	0: PF6 1: PF8 2: PB10 3: PC1	4: PF6 5: PF6	External Bus Interface (EBI) Byte Lane/Enable pin 0.
EBI_BL1	0: PF7 1: PF9 2: PB11 3: PC3	4: PF7 5: PF7	External Bus Interface (EBI) Byte Lane/Enable pin 1.
EBI_CS0	0: PD9 1: PA10 2: PC0 3: PB0	4: PE8	External Bus Interface (EBI) Chip Select output 0.
EBI_CS1	0: PD10 1: PA11 2: PC1 3: PB1	4: PE9	External Bus Interface (EBI) Chip Select output 1.
EBI_CS2	0: PD11 1: PA12 2: PC2 3: PB2	4: PE10	External Bus Interface (EBI) Chip Select output 2.

Alternate	LOCATION		
Functionality	0 - 3	4 - 7	Description
EBI_CS3	0: PD12 1: PB15 2: PC3 3: PB3	4: PE11	External Bus Interface (EBI) Chip Select output 3.
EBI_CSTFT	0: PA7 1: PF6 3: PA0		External Bus Interface (EBI) Chip Select output TFT.
EBI_DCLK	0: PA8 1: PF7 3: PA1		External Bus Interface (EBI) TFT Dot Clock pin.
EBI_DTEN	0: PA9 1: PD9 3: PA2		External Bus Interface (EBI) TFT Data Enable pin.
EBI_HSNC	0: PA11 1: PD11 3: PA4		External Bus Interface (EBI) TFT Horizontal Synchronization pin.
EBI_NANDREn	0: PC3 1: PD15 2: PB9 3: PC4	4: PC15 5: PF12	External Bus Interface (EBI) NAND Read Enable output.
EBI_NANDWEn	0: PC5 1: PD14 2: PA13 3: PC2	4: PC14 5: PF11	External Bus Interface (EBI) NAND Write Enable output.
EBI_REn	0: PF5 1: PA14 2: PA12 3: PC0	4: PF9 5: PF5	External Bus Interface (EBI) Read Enable output.
EBI_VSNC	0: PA10 1: PD10 3: PA3		External Bus Interface (EBI) TFT Vertical Synchronization pin.
EBI_WEn	0: PF4 1: PA13 2: PC5 3: PB6	4: PF8 5: PF4	External Bus Interface (EBI) Write Enable output.

Alternate	LOCATION		
Functionality	0 - 3	4 - 7	Description
ETM_TCLK	0: PD7 1: PF8 2: PC6 3: PA6	4: PE11	Embedded Trace Module ETM clock .
ETM_TD0	0: PD6 1: PF9 2: PC7 3: PA2	4: PE12	Embedded Trace Module ETM data 0.
ETM_TD1	0: PD3 1: PD13 2: PD3 3: PA3	4: PE13	Embedded Trace Module ETM data 1.
ETM_TD2	0: PD4 1: PB15 2: PD4 3: PA4	4: PE14	Embedded Trace Module ETM data 2.
ETM_TD3	0: PD5 1: PF3 2: PD5 3: PA5	4: PE15	Embedded Trace Module ETM data 3.
GPIO_EM4WU0	0: PA0		Pin can be used to wake the system up from EM4
GPIO_EM4WU1	0: PA6		Pin can be used to wake the system up from EM4
GPIO_EM4WU2	0: PC9		Pin can be used to wake the system up from EM4
GPIO_EM4WU3	0: PF1		Pin can be used to wake the system up from EM4
GPIO_EM4WU4	0: PF2		Pin can be used to wake the system up from EM4
GPIO_EM4WU5	0: PE13		Pin can be used to wake the system up from EM4
GPIO_EM4WU6	0: PC4		Pin can be used to wake the system up from EM4
GPIO_EM4WU7	0: PB11		Pin can be used to wake the system up from EM4
GPIO_EM4WU8	0: PF8		Pin can be used to wake the system up from EM4
GPIO_EM4WU9	0: PE10		Pin can be used to wake the system up from EM4
HFXTAL_N	0: PB14		High Frequency Crystal negative pin. Also used as external optional clock input pin.
HFXTAL_P	0: PB13		High Frequency Crystal positive pin.
I2C0_SCL	0: PA1 1: PD7 2: PC7 3: PD15	4: PC1 5: PF1 6: PE13 7: PE5	I2C0 Serial Clock Line input / output.

Alternate	LOCATION		Description
	0 - 3	4 - 7	
I2C0_SDA	0: PA0 1: PD6 2: PC6 3: PD14	4: PC0 5: PF0 6: PE12 7: PE4	I2C0 Serial Data input / output.
I2C1_SCL	0: PC5 1: PB12 2: PE1 3: PD5	4: PF2	I2C1 Serial Clock Line input / output.
I2C1_SDA	0: PC4 1: PB11 2: PE0 3: PD4	4: PC11	I2C1 Serial Data input / output.
IDAC0_OUT	0: PB11		IDAC0 output.
LCD_BEXT	0: PA14		LCD external supply bypass in step down or charge pump mode. If using the LCD in step-down or charge pump mode, a 1 uF (minimum) capacitor between this pin and VSS is required. To reduce supply ripple, a larger capacitor of approximately 1000 times the total LCD segment capacitance may be used. If using the LCD with the internal supply source, this pin may be left unconnected or used as a GPIO.
LCD_COM0	0: PE4		LCD driver common line number 0.
LCD_COM1	0: PE5		LCD driver common line number 1.
LCD_COM2	0: PE6		LCD driver common line number 2.
LCD_COM3	0: PE7		LCD driver common line number 3.
LCD_SEG0	0: PF2		LCD segment line 0.
LCD_SEG1	0: PF3		LCD segment line 1.
LCD_SEG2	0: PF4		LCD segment line 2.
LCD_SEG3	0: PF5		LCD segment line 3.
LCD_SEG4	0: PE8		LCD segment line 4.
LCD_SEG5	0: PE9		LCD segment line 5.
LCD_SEG6	0: PE10		LCD segment line 6.
LCD_SEG7	0: PE11		LCD segment line 7.
LCD_SEG8	0: PE12		LCD segment line 8.
LCD_SEG9	0: PE13		LCD segment line 9.
LCD_SEG10	0: PE14		LCD segment line 10.
LCD_SEG11	0: PE15		LCD segment line 11.
LCD_SEG12	0: PA15		LCD segment line 12.

Alternate	LOCATION		Description
	0 - 3	4 - 7	
LCD_SEG13	0: PA0		LCD segment line 13.
LCD_SEG14	0: PA1		LCD segment line 14.
LCD_SEG15	0: PA2		LCD segment line 15.
LCD_SEG16	0: PA3		LCD segment line 16.
LCD_SEG17	0: PA4		LCD segment line 17.
LCD_SEG18	0: PA5		LCD segment line 18.
LCD_SEG19	0: PA6		LCD segment line 19.
LCD_SEG20 / LCD_COM4	0: PB3		LCD segment line 20. This pin may also be used as LCD COM line 4
LCD_SEG21 / LCD_COM5	0: PB4		LCD segment line 21. This pin may also be used as LCD COM line 5
LCD_SEG22 / LCD_COM6	0: PB5		LCD segment line 22. This pin may also be used as LCD COM line 6
LCD_SEG23 / LCD_COM7	0: PB6		LCD segment line 23. This pin may also be used as LCD COM line 7
LCD_SEG24	0: PF6		LCD segment line 24.
LCD_SEG25	0: PF7		LCD segment line 25.
LCD_SEG26	0: PF8		LCD segment line 26.
LCD_SEG27	0: PF9		LCD segment line 27.
LCD_SEG28	0: PD9		LCD segment line 28.
LCD_SEG29	0: PD10		LCD segment line 29.
LCD_SEG30	0: PD11		LCD segment line 30.
LCD_SEG31	0: PD12		LCD segment line 31.
LCD_SEG32	0: PB0		LCD segment line 32.
LCD_SEG33	0: PB1		LCD segment line 33.
LCD_SEG34	0: PB2		LCD segment line 34.
LCD_SEG35	0: PA7		LCD segment line 35.
LCD_SEG36	0: PA8		LCD segment line 36.
LCD_SEG37	0: PA9		LCD segment line 37.
LCD_SEG38	0: PA10		LCD segment line 38.
LCD_SEG39	0: PA11		LCD segment line 39.
LES_ALTEX0	0: PD6		LESENSE alternate excite output 0.
LES_ALTEX1	0: PD7		LESENSE alternate excite output 1.
LES_ALTEX2	0: PA3		LESENSE alternate excite output 2.
LES_ALTEX3	0: PA4		LESENSE alternate excite output 3.
LES_ALTEX4	0: PA5		LESENSE alternate excite output 4.
LES_ALTEX5	0: PE11		LESENSE alternate excite output 5.
LES_ALTEX6	0: PE12		LESENSE alternate excite output 6.

Alternate	LOCATION		Description
	0 - 3	4 - 7	
LES_ALTEX7	0: PE13		LESENSE alternate excite output 7.
LES_CH0	0: PC0		LESENSE channel 0.
LES_CH1	0: PC1		LESENSE channel 1.
LES_CH2	0: PC2		LESENSE channel 2.
LES_CH3	0: PC3		LESENSE channel 3.
LES_CH4	0: PC4		LESENSE channel 4.
LES_CH5	0: PC5		LESENSE channel 5.
LES_CH6	0: PC6		LESENSE channel 6.
LES_CH7	0: PC7		LESENSE channel 7.
LES_CH8	0: PC8		LESENSE channel 8.
LES_CH9	0: PC9		LESENSE channel 9.
LES_CH10	0: PC10		LESENSE channel 10.
LES_CH11	0: PC11		LESENSE channel 11.
LES_CH12	0: PC12		LESENSE channel 12.
LES_CH13	0: PC13		LESENSE channel 13.
LES_CH14	0: PC14		LESENSE channel 14.
LES_CH15	0: PC15		LESENSE channel 15.
LETIM0_OUT0	0: PD6 1: PB11 2: PF0 3: PC4	4: PE12 5: PC14 6: PA8 7: PB9	Low Energy Timer LETIM0, output channel 0.
LETIM0_OUT1	0: PD7 1: PB12 2: PF1 3: PC5	4: PE13 5: PC15 6: PA9 7: PB10	Low Energy Timer LETIM0, output channel 1.
LETIM1_OUT0	0: PA7 1: PA11 2: PA12 3: PC2	4: PB5 5: PB2	Low Energy Timer LETIM1, output channel 0.
LETIM1_OUT1	0: PA6 1: PA13 2: PA14 3: PC3	4: PB6 5: PB1	Low Energy Timer LETIM1, output channel 1.

Alternate	LOCATION		Description
	0 - 3	4 - 7	
LEU0_RX	0: PD5 1: PB14 2: PE15 3: PF1	4: PA0 5: PC15	LEUART0 Receive input.
LEU0_TX	0: PD4 1: PB13 2: PE14 3: PF0	4: PF2 5: PC14	LEUART0 Transmit output. Also used as receive input in half duplex communication.
LEU1_RX	0: PC7 1: PA6 2: PD3 3: PB1	4: PB5	LEUART1 Receive input.
LEU1_TX	0: PC6 1: PA5 2: PD2 3: PB0	4: PB4	LEUART1 Transmit output. Also used as receive input in half duplex communication.
LFXTAL_N	0: PB8		Low Frequency Crystal (typically 32.768 kHz) negative pin. Also used as an optional external clock input pin.
LFXTAL_P	0: PB7		Low Frequency Crystal (typically 32.768 kHz) positive pin.
OPA0_N	0: PC5		Operational Amplifier 0 external negative input.
OPA0_P	0: PC4		Operational Amplifier 0 external positive input.
OPA1_N	0: PD7		Operational Amplifier 1 external negative input.
OPA1_P	0: PD6		Operational Amplifier 1 external positive input.
OPA2_N	0: PD3		Operational Amplifier 2 external negative input.
OPA2_OUT	0: PD5		Operational Amplifier 2 output.
OPA2_OUTALT	0: PD0		Operational Amplifier 2 alternative output.
OPA2_P	0: PD4		Operational Amplifier 2 external positive input.
OPA3_N	0: PC7		Operational Amplifier 3 external negative input.
OPA3_OUT	0: PD1		Operational Amplifier 3 output.
OPA3_P	0: PC6		Operational Amplifier 3 external positive input.
PCNT0_S0IN	0: PC13 1: PE0 2: PC0 3: PD6	4: PA0 5: PB0 6: PB5 7: PB12	Pulse Counter PCNT0 input number 0.

Alternate	LOCATION		
Functionality	0 - 3	4 - 7	Description
PCNT0_S1IN	0: PC14 1: PE1 2: PC1 3: PD7	4: PA1 5: PB1 6: PB6 7: PB11	Pulse Counter PCNT0 input number 1.
PCNT1_S0IN	0: PA5 1: PB3 2: PD15 3: PC4	4: PA7 5: PA12 6: PB11	Pulse Counter PCNT1 input number 0.
PCNT1_S1IN	0: PA6 1: PB4 2: PB0 3: PC5	4: PA8 5: PA13 6: PB12	Pulse Counter PCNT1 input number 1.
PCNT2_S0IN	0: PD0 1: PE8 2: PB13 3: PF10	4: PC12	Pulse Counter PCNT2 input number 0.
PCNT2_S1IN	0: PD1 1: PE9 2: PB14 3: PF11	4: PC13	Pulse Counter PCNT2 input number 1.
PDM_CLK	0: PA0 1: PE8 2: PF6 3: PB12	4: PD0	PDM Clock Output.
PDM_DAT0	0: PA1 1: PE9 2: PF7 3: PB11	4: PD1	PDM Data 0.
PDM_DAT1	0: PA2 1: PE10 2: PF8 3: PB10	4: PD2	PDM Data 1.
PDM_DAT2	0: PA3 1: PE11 2: PF9 3: PB9	4: PD3	PDM Data 2.

Alternate	LOCATION		Description
	0 - 3	4 - 7	
PDM_DAT3	0: PA4 1: PE12 2: PD9 3: PA13	4: PD4	PDM Data 3.
PRS_CH0	0: PA0 1: PF3 2: PC14 3: PF2		Peripheral Reflex System PRS, channel 0.
PRS_CH1	0: PA1 1: PF4 2: PC15 3: PE12		Peripheral Reflex System PRS, channel 1.
PRS_CH2	0: PC0 1: PF5 2: PE10 3: PE13		Peripheral Reflex System PRS, channel 2.
PRS_CH3	0: PC1 1: PE8 2: PE11 3: PA0		Peripheral Reflex System PRS, channel 3.
PRS_CH4	0: PC8 1: PB0 2: PF1		Peripheral Reflex System PRS, channel 4.
PRS_CH5	0: PC9 1: PB1 2: PD6		Peripheral Reflex System PRS, channel 5.
PRS_CH6	0: PA6 1: PB14 2: PE6		Peripheral Reflex System PRS, channel 6.
PRS_CH7	0: PB13 1: PA7 2: PE7		Peripheral Reflex System PRS, channel 7.
PRS_CH8	0: PA8 1: PA2 2: PE9		Peripheral Reflex System PRS, channel 8.

Alternate	LOCATION		Description
	0 - 3	4 - 7	
PRS_CH9	0: PA9 1: PA3 2: PB10		Peripheral Reflex System PRS, channel 9.
PRS_CH10	0: PA10 1: PC2 2: PD4		Peripheral Reflex System PRS, channel 10.
PRS_CH11	0: PA11 1: PC3 2: PD5		Peripheral Reflex System PRS, channel 11.
PRS_CH12	0: PA12 1: PB6 2: PD8		Peripheral Reflex System PRS, channel 12.
PRS_CH13	0: PA13 1: PB9 2: PE14		Peripheral Reflex System PRS, channel 13.
PRS_CH14	0: PA14 1: PC6 2: PE15		Peripheral Reflex System PRS, channel 14.
PRS_CH15	0: PA15 1: PC7 2: PF0		Peripheral Reflex System PRS, channel 15.
QSPI0_CS0	0: PF7 1: PA0		Quad SPI 0 Chip Select 0.
QSPI0_CS1	0: PF8 1: PA1		Quad SPI 0 Chip Select 1.
QSPI0_DQ0	0: PD9 1: PA2		Quad SPI 0 Data 0.
QSPI0_DQ1	0: PD10 1: PA3		Quad SPI 0 Data 1.
QSPI0_DQ2	0: PD11 1: PA4		Quad SPI 0 Data 2.
QSPI0_DQ3	0: PD12 1: PA5		Quad SPI 0 Data 3.
QSPI0_DQ4	0: PE8 1: PB3		Quad SPI 0 Data 4.

Alternate	LOCATION		Description
	0 - 3	4 - 7	
QSPI0_DQ5	0: PE9 1: PB4		Quad SPI 0 Data 5.
QSPI0_DQ6	0: PE10 1: PB5		Quad SPI 0 Data 6.
QSPI0_DQ7	0: PE11 1: PB6		Quad SPI 0 Data 7.
QSPI0_DQS	0: PF9 1: PE15		Quad SPI 0 Data S.
QSPI0_RST0	0: PE14 1: PC2		Quad SPI 0 Reset 0.
QSPI0_RST1	0: PE15 1: PC3		Quad SPI 0 Reset 1.
QSPI0_SCLK	0: PF6 1: PE14		Quad SPI 0 Serial Clock.
SDIO_CD	0: PF8 1: PC4 2: PA6 3: PB10		SDIO Card Detect.
SDIO_CLK	0: PE13 1: PE14		SDIO Serial Clock.
SDIO_CMD	0: PE12 1: PE15		SDIO Command.
SDIO_DAT0	0: PE11 1: PA0		SDIO Data 0.
SDIO_DAT1	0: PE10 1: PA1		SDIO Data 1.
SDIO_DAT2	0: PE9 1: PA2		SDIO Data 2.
SDIO_DAT3	0: PE8 1: PA3		SDIO Data 3.
SDIO_DAT4	0: PD12 1: PA4		SDIO Data 4.
SDIO_DAT5	0: PD11 1: PA5		SDIO Data 5.
SDIO_DAT6	0: PD10 1: PB3		SDIO Data 6.

Alternate	LOCATION		
Functionality	0 - 3	4 - 7	Description
SDIO_DAT7	0: PD9 1: PB4		SDIO Data 7.
SDIO_WP	0: PF9 1: PC5 2: PB15 3: PB9		SDIO Write Protect.
TIM0_CC0	0: PA0 1: PF6 2: PD1 3: PB6	4: PF0 5: PC4 6: PA8 7: PA1	Timer 0 Capture Compare input / output channel 0.
TIM0_CC1	0: PA1 1: PF7 2: PD2 3: PC0	4: PF1 5: PC5 6: PA9 7: PA0	Timer 0 Capture Compare input / output channel 1.
TIM0_CC2	0: PA2 1: PF8 2: PD3 3: PC1	4: PF2 5: PA7 6: PA10 7: PA13	Timer 0 Capture Compare input / output channel 2.
TIM0_CDT10	0: PA3 1: PC13 2: PF3 3: PC2	4: PB7	Timer 0 Complimentary Dead Time Insertion channel 0.
TIM0_CDT11	0: PA4 1: PC14 2: PF4 3: PC3	4: PB8	Timer 0 Complimentary Dead Time Insertion channel 1.
TIM0_CDT12	0: PA5 1: PC15 2: PF5 3: PC4	4: PB11	Timer 0 Complimentary Dead Time Insertion channel 2.
TIM1_CC0	0: PC13 1: PE10 2: PB0 3: PB7	4: PD6 5: PF2 6: PF13	Timer 1 Capture Compare input / output channel 0.

Alternate	LOCATION		Description
	0 - 3	4 - 7	
TIM1_CC1	0: PC14 1: PE11 2: PB1 3: PB8	4: PD7 5: PF3 6: PF14	Timer 1 Capture Compare input / output channel 1.
TIM1_CC2	0: PC15 1: PE12 2: PB2 3: PB11	4: PC13 5: PF4	Timer 1 Capture Compare input / output channel 2.
TIM1_CC3	0: PC12 1: PE13 2: PB3 3: PB12	4: PC14 5: PF12 6: PF5	Timer 1 Capture Compare input / output channel 3.
TIM2_CC0	0: PA8 1: PA12 2: PC8 3: PF2	4: PB6 5: PC2	Timer 2 Capture Compare input / output channel 0.
TIM2_CC1	0: PA9 1: PA13 2: PC9 3: PE12	4: PC0 5: PC3	Timer 2 Capture Compare input / output channel 1.
TIM2_CC2	0: PA10 1: PA14 2: PC10 3: PE13	4: PC1 5: PC4	Timer 2 Capture Compare input / output channel 2.
TIM2_CDT10	0: PB0 1: PD13 2: PE8		Timer 2 Complimentary Dead Time Insertion channel 0.
TIM2_CDT11	0: PB1 1: PD14 2: PE14		Timer 2 Complimentary Dead Time Insertion channel 1.
TIM2_CDT12	0: PB2 1: PD15 2: PE15		Timer 2 Complimentary Dead Time Insertion channel 2.

Alternate	LOCATION		Description
	0 - 3	4 - 7	
TIM3_CC0	0: PE14 1: PE0 2: PE3 3: PE5	4: PA0 5: PA3 6: PA6 7: PD15	Timer 3 Capture Compare input / output channel 0.
TIM3_CC1	0: PE15 1: PE1 2: PE4 3: PE6	4: PA1 5: PA4 6: PD13 7: PB15	Timer 3 Capture Compare input / output channel 1.
TIM3_CC2	0: PA15 1: PE2 2: PE5 3: PE7	4: PA2 5: PA5 6: PD14 7: PB0	Timer 3 Capture Compare input / output channel 2.
U0_CTS	0: PF8 1: PE2 2: PA5 3: PC13	4: PB7 5: PD5	UART0 Clear To Send hardware flow control input.
U0_RTS	0: PF9 1: PE3 2: PA6 3: PC12	4: PB8 5: PD6	UART0 Request To Send hardware flow control output.
U0_RX	0: PF7 1: PE1 2: PA4 3: PC15	4: PC5 5: PF2 6: PE4	UART0 Receive input.
U0_TX	0: PF6 1: PE0 2: PA3 3: PC14	4: PC4 5: PF1 6: PD7	UART0 Transmit output. Also used as receive input in half duplex communication.
U1_CTS	0: PC14 1: PF9 2: PB11 3: PE4	4: PC4	UART1 Clear To Send hardware flow control input.
U1_RTS	0: PC15 1: PF8 2: PB12 3: PE5	4: PC5	UART1 Request To Send hardware flow control output.

Alternate	LOCATION		
Functionality	0 - 3	4 - 7	Description
U1_RX	0: PC13 1: PF11 2: PB10 3: PE3	4: PE13	UART1 Receive input.
U1_TX	0: PC12 1: PF10 2: PB9 3: PE2	4: PE12	UART1 Transmit output. Also used as receive input in half duplex communication.
US0_CLK	0: PE12 1: PE5 2: PC9 3: PC15	4: PB13 5: PA12	USART0 clock input / output.
US0_CS	0: PE13 1: PE4 2: PC8 3: PC14	4: PB14 5: PA13	USART0 chip select input / output.
US0_CTS	0: PE14 1: PE3 2: PC7 3: PC13	4: PB6 5: PB11	USART0 Clear To Send hardware flow control input.
US0_RTS	0: PE15 1: PE2 2: PC6 3: PC12	4: PB5 5: PD6	USART0 Request To Send hardware flow control output.
US0_RX	0: PE11 1: PE6 2: PC10 3: PE12	4: PB8 5: PC1	USART0 Asynchronous Receive. USART0 Synchronous mode Master Input / Slave Output (MISO).
US0_TX	0: PE10 1: PE7 2: PC11 3: PE13	4: PB7 5: PC0	USART0 Asynchronous Transmit. Also used as receive input in half duplex communication. USART0 Synchronous mode Master Output / Slave Input (MOSI).
US1_CLK	0: PB7 1: PD2 2: PF0 3: PC15	4: PC3 5: PB11 6: PE5	USART1 clock input / output.

Alternate	LOCATION		
Functionality	0 - 3	4 - 7	Description
US1_CS	0: PB8 1: PD3 2: PF1 3: PC14	4: PC0 5: PE4 6: PB2	USART1 chip select input / output.
US1_CTS	0: PB9 1: PD4 2: PF3 3: PC6	4: PC12 5: PB13	USART1 Clear To Send hardware flow control input.
US1_RTS	0: PB10 1: PD5 2: PF4 3: PC7	4: PC13 5: PB14	USART1 Request To Send hardware flow control output.
US1_RX	0: PC1 1: PD1 2: PD6 3: PF7	4: PC2 5: PA0 6: PA2	USART1 Asynchronous Receive. USART1 Synchronous mode Master Input / Slave Output (MISO).
US1_TX	0: PC0 1: PD0 2: PD7 3: PF6	4: PC1 5: PF2 6: PA14	USART1 Asynchronous Transmit. Also used as receive input in half duplex communication. USART1 Synchronous mode Master Output / Slave Input (MOSI).
US2_CLK	0: PC4 1: PB5 2: PA9 3: PA15	4: PF8 5: PF2	USART2 clock input / output.
US2_CS	0: PC5 1: PB6 2: PA10 3: PB11	4: PF9 5: PF5	USART2 chip select input / output.
US2_CTS	0: PC1 1: PB12 2: PA11 3: PB10	4: PC12 5: PD6	USART2 Clear To Send hardware flow control input.
US2_RTS	0: PC0 1: PB15 2: PA12 3: PC14	4: PC13 5: PD8	USART2 Request To Send hardware flow control output.

Alternate	LOCATION		
Functionality	0 - 3	4 - 7	Description
US2_RX	0: PC3 1: PB4 2: PA8 3: PA14	4: PF7 5: PF1	USART2 Asynchronous Receive. USART2 Synchronous mode Master Input / Slave Output (MISO).
US2_TX	0: PC2 1: PB3 2: PA7 3: PA13	4: PF6 5: PF0	USART2 Asynchronous Transmit. Also used as receive input in half duplex communication. USART2 Synchronous mode Master Output / Slave Input (MOSI).
US3_CLK	0: PA2 1: PD7 2: PD4		USART3 clock input / output.
US3_CS	0: PA3 1: PE4 2: PC14 3: PC0		USART3 chip select input / output.
US3_CTS	0: PA4 1: PE5 2: PD6		USART3 Clear To Send hardware flow control input.
US3_RTS	0: PA5 1: PC1 2: PA14 3: PC15		USART3 Request To Send hardware flow control output.
US3_RX	0: PA1 1: PE7 2: PB7		USART3 Asynchronous Receive. USART3 Synchronous mode Master Input / Slave Output (MISO).
US3_TX	0: PA0 1: PE6 2: PB3		USART3 Asynchronous Transmit. Also used as receive input in half duplex communication. USART3 Synchronous mode Master Output / Slave Input (MOSI).
US4_CLK	0: PC4 1: PD11		USART4 clock input / output.
US4_CS	0: PC5 1: PD12		USART4 chip select input / output.
US4_CTS	0: PA7 1: PD13		USART4 Clear To Send hardware flow control input.
US4_RTS	0: PA8 1: PD14		USART4 Request To Send hardware flow control output.

Alternate	LOCATION		Description
	0 - 3	4 - 7	
US4_RX	0: PB8		USART4 Asynchronous Receive.
	1: PD10		USART4 Synchronous mode Master Input / Slave Output (MISO).
US4_TX	0: PB7		USART4 Asynchronous Transmit. Also used as receive input in half duplex communication.
	1: PD9		USART4 Synchronous mode Master Output / Slave Input (MOSI).
USB_DM	0: PF10		USB D- pin.
USB_DP	0: PF11		USB D+ pin.
USB_ID	0: PF12		USB ID pin.
USB_VBUSEN	0: PF5		USB 5 V VBUS enable.
	1: PE4		
	2: PD0		
VDAC0_EXT	0: PD6		Digital to analog converter VDAC0 external reference input pin.
VDAC0_OUT0 / OPA0_OUT	0: PB11		Digital to Analog Converter DAC0 output channel number 0.
VDAC0_OUT0ALT / OPA0_OUTALT	0: PC0	4: PD0	Digital to Analog Converter DAC0 alternative output for channel 0.
	1: PC1		
	2: PC2		
	3: PC3		
VDAC0_OUT1 / OPA1_OUT	0: PB12		Digital to Analog Converter DAC0 output channel number 1.
VDAC0_OUT1ALT / OPA1_OUTALT	0: PC12	4: PD1	Digital to Analog Converter DAC0 alternative output for channel 1.
	1: PC13		
	2: PC14		
	3: PC15		
WTIM0_CC0	0: PE4	4: PC15	Wide timer 0 Capture Compare input / output channel 0.
	1: PA6	5: PB0	
		6: PB3	
		7: PC1	
WTIM0_CC1	0: PE5	4: PF0	Wide timer 0 Capture Compare input / output channel 1.
	1: PD13	5: PB1	
		6: PB4	
		7: PC2	
WTIM0_CC2	0: PE6	4: PF1	Wide timer 0 Capture Compare input / output channel 2.
	1: PD14	5: PB2	
		6: PB5	
		7: PC3	

Alternate	LOCATION		Description
	0 - 3	4 - 7	
WTIM0_CDTI0	0: PE10 1: PD15 2: PA12	4: PD4	Wide timer 0 Complimentary Dead Time Insertion channel 0.
WTIM0_CDTI1	0: PE11 2: PA13	4: PD5	Wide timer 0 Complimentary Dead Time Insertion channel 1.
WTIM0_CDTI2	0: PE12 2: PA14	4: PD6	Wide timer 0 Complimentary Dead Time Insertion channel 2.
WTIM1_CC0	0: PB13 1: PD2 2: PD6 3: PC7	4: PE3 5: PE7	Wide timer 1 Capture Compare input / output channel 0.
WTIM1_CC1	0: PB14 1: PD3 2: PD7 3: PE0	4: PE4	Wide timer 1 Capture Compare input / output channel 1.
WTIM1_CC2	0: PD0 1: PD4 2: PD8 3: PE1	4: PE5	Wide timer 1 Capture Compare input / output channel 2.
WTIM1_CC3	0: PD1 1: PD5 2: PC6 3: PE2	4: PE6	Wide timer 1 Capture Compare input / output channel 3.

Certain alternate function locations may have non-interference priority. These locations will take precedence over any other functions selected on that pin (i.e. another alternate function enabled to the same pin inadvertently).

Some alternate functions may also have high speed priority on certain locations. These locations ensure the fastest possible paths to the pins for timing-critical signals.

The following table lists the alternate functions and locations with special priority.

Table 5.22. Alternate Functionality Priority

Alternate Functionality	Location	Priority
CMU_CLK2	1: PA3 5: PD10	High Speed High Speed
CMU_CLKI0	1: PA3 5: PD10	High Speed High Speed
PDM_CLK	0: PA0	High Speed
PDM_DAT0	0: PA1	High Speed

Alternate Functionality	Location	Priority
PDM_DAT1	0: PA2	High Speed
PDM_DAT2	0: PA3	High Speed
PDM_DAT3	0: PA4	High Speed
QSPI0_CS0	0: PF7	High Speed
QSPI0_CS1	0: PF8	High Speed
QSPI0_DQ0	0: PD9	High Speed
QSPI0_DQ1	0: PD10	High Speed
QSPI0_DQ2	0: PD11	High Speed
QSPI0_DQ3	0: PD12	High Speed
QSPI0_DQ4	0: PE8	High Speed
QSPI0_DQ5	0: PE9	High Speed
QSPI0_DQ6	0: PE10	High Speed
QSPI0_DQ7	0: PE11	High Speed
QSPI0_DQS	0: PF9	High Speed
QSPI0_RST0	0: PE14	High Speed
QSPI0_RST1	0: PE15	High Speed
QSPI0_SCLK	0: PF6	High Speed
SDIO_CLK	0: PE13	High Speed
SDIO_CMD	0: PE12	High Speed
SDIO_DAT0	0: PE11	High Speed
SDIO_DAT1	0: PE10	High Speed
SDIO_DAT2	0: PE9	High Speed
SDIO_DAT3	0: PE8	High Speed
SDIO_DAT4	0: PD12	High Speed
SDIO_DAT5	0: PD11	High Speed
SDIO_DAT6	0: PD10	High Speed
SDIO_DAT7	0: PD9	High Speed
TIM0_CC0	3: PB6	Non-interference
TIM0_CC1	3: PC0	Non-interference
TIM0_CC2	3: PC1	Non-interference
TIM0_CDTI0	1: PC13	Non-interference
TIM0_CDTI1	1: PC14	Non-interference
TIM0_CDTI2	1: PC15	Non-interference
TIM2_CC0	0: PA8	Non-interference
TIM2_CC1	0: PA9	Non-interference
TIM2_CC2	0: PA10	Non-interference
TIM2_CDTI0	0: PB0	Non-interference

Alternate Functionality	Location	Priority
TIM2_CDT11	0: PB1	Non-interference
TIM2_CDT12	0: PB2	Non-interference
US2_CLK	4: PF8 5: PF2	High Speed High Speed
US2_CS	4: PF9 5: PF5	High Speed High Speed
US2_RX	4: PF7 5: PF1	High Speed High Speed
US2_TX	4: PF6 5: PF0	High Speed High Speed

5.22 Analog Port (APORT) Client Maps

The Analog Port (APORT) is an infrastructure used to connect chip pins with on-chip analog clients such as analog comparators, ADCs, DACs, etc. The APORT consists of a set of shared buses, switches, and control logic needed to configurably implement the signal routing. Figure 5.20 APORT Connection Diagram on page 204 shows the APORT routing for this device family (note that available features may vary by part number). A complete description of APORT functionality can be found in the Reference Manual.



Figure 5.20. APORT Connection Diagram

Client maps for each analog circuit using the APORT are shown in the following tables. The maps are organized by bus, and show the peripheral's port connection, the shared bus, and the connection from specific bus channel numbers to GPIO pins.

In general, enumerations for the pin selection field in an analog peripheral's register can be determined by finding the desired pin connection in the table and then combining the value in the Port column (APORT__), and the channel identifier (CH__). For example, if pin

PF7 is available on port APORT2X as CH23, the register field enumeration to connect to PF7 would be APORT2XCH23. The shared bus used by this connection is indicated in the Bus column.

Table 5.23. ACMP0 Bus and Pin Mapping

APORT4Y	APORT4X	APORT3Y	APORT3X	APORT2Y	APORT2X	APORT1Y	APORT1X	APORT0Y	APORT0X	Port
BUSDY	BUSDX	BUSCY	BUSCX	BUSBY	BUSBX	BUSAY	BUSAX	BUSACMP0Y	BUSACMP0X	Bus
PF14			PF14	PB14	PB15	PB15	PB14			CH31
	PF13	PF13								CH30
PF12			PF12	PB12	PB13	PB13	PB12			CH29
	PF11	PF11			PB11	PB11				CH28
PF10			PF10	PB10			PB10			CH27
	PF9	PF9			PB9	PB9				CH26
PF8			PF8							CH25
	PF7	PF7								CH24
PF6			PF6	PB6			PB6			CH23
	PF5	PF5								CH22
PF4			PF4	PB4			PB4			CH21
	PF3	PF3			PB3	PB3				CH20
PF2			PF2	PB2			PB2			CH19
	PF1	PF1			PB1	PB1				CH18
PF0			PF0	PB0			PB0			CH17
	PE15	PE15			PA15	PA15				CH16
PE14			PE14	PA14			PA14			CH15
	PE13	PE13			PA13	PA13				CH14
PE12			PE12	PA12			PA12			CH13
	PE11	PE11			PA11	PA11				CH12
PE10			PE10	PA10			PA10			CH11
	PE9	PE9			PA9	PA9				CH10
PE8			PE8	PA8			PA8			CH9
	PE7	PE7			PA7	PA7				CH8
PE6			PE6	PA6			PA6	PC7	PC7	CH7
	PE5	PE5			PA5	PA5		PC6	PC6	CH6
PE4			PE4	PA4			PA4	PC5	PC5	CH5
					PA3	PA3		PC4	PC4	CH4
							PA2	PC3	PC3	CH3
							PA1	PC2	PC2	CH2
	PE1	PE1			PA1	PA1		PC1	PC1	CH1
PE0			PE0	PA0			PA0	PC0	PC0	CH0

Table 5.24. ACMP1 Bus and Pin Mapping

APORT4Y	APORT4X	APORT3Y	APORT3X	APORT2Y	APORT2X	APORT1Y	APORT1X	APORT0Y	APORT0X	Port
BUSDY	BUSDX	BUSCY	BUSCX	BUSBY	BUSBX	BUSAY	BUSAX	BUSACMP1Y	BUSACMP1X	Bus
PF14			PF14	PB14		PB15	PB14			CH31
	PF13	PF13								CH30
PF12			PF12	PB12		PB13	PB12			CH29
	PF11	PF11				PB11	PB11			CH28
PF10			PF10	PB10			PB10			CH27
	PF9	PF9				PB9				CH26
PF8			PF8							CH25
	PF7	PF7								CH24
PF6			PF6	PB6			PB6			CH23
	PF5	PF5				PB5				CH22
PF4			PF4	PB4			PB4			CH21
	PF3	PF3				PB3				CH20
PF2			PF2	PB2			PB2			CH19
	PF1	PF1				PB1				CH18
PF0			PF0	PB0			PB0			CH17
	PE15	PE15				PA15				CH16
PE14			PE14	PA14			PA14			CH15
	PE13	PE13				PA13				CH14
PE12			PE12	PA12			PA12			CH13
	PE11	PE11				PA11				CH12
PE10			PE10	PA10			PA10			CH11
	PE9	PE9				PA9				CH10
PE8			PE8	PA8			PA8			CH9
	PE7	PE7				PA7				CH8
PE6			PE6	PA6			PA6	PC15	PC15	CH7
	PE5	PE5					PA5	PC14	PC14	CH6
PE4			PE4	PA4			PA4	PC13	PC13	CH5
								PC12	PC12	CH4
								PC11	PC11	CH3
								PC10	PC10	CH2
	PE1	PE1						PC9	PC9	CH1
PE0			PE0	PA0				PC8	PC8	CH0

Table 5.25. ACMP2 Bus and Pin Mapping

APORT4Y	APORT4X	APORT3Y	APORT3X	APORT2Y	APORT2X	APORT1Y	APORT1X	Port
BUSDY	BUSDX	BUSCY	BUSCX	BUSBY	BUSBX	BUSAY	BUSAX	Bus
PF14			PF14	PB14	PB15	PB15	PB14	CH31
	PF13	PF13			PB13	PB13		CH30
PF12			PF12	PB12			PB12	CH29
	PF11	PF11			PB11	PB11		CH28
PF10			PF10	PB10			PB10	CH27
	PF9	PF9			PB9	PB9		CH26
PF8			PF8					CH25
	PF7	PF7						CH24
PF6			PF6	PB6			PB6	CH23
	PF5	PF5			PB5	PB5		CH22
PF4			PF4	PB4			PB4	CH21
	PF3	PF3			PB3	PB3		CH20
PF2			PF2	PB2			PB2	CH19
	PF1	PF1			PB1	PB1		CH18
PF0			PF0	PB0			PB0	CH17
	PE15	PE15			PA15	PA15		CH16
PE14			PE14	PA14			PA14	CH15
	PE13	PE13			PA13	PA13		CH14
PE12			PE12	PA12			PA12	CH13
	PE11	PE11			PA11	PA11		CH12
PE10			PE10	PA10			PA10	CH11
	PE9	PE9			PA9	PA9		CH10
PE8			PE8	PA8			PA8	CH9
	PE7	PE7			PA7	PA7		CH8
PE6			PE6	PA6			PA6	CH7
	PE5	PE5			PA5	PA5		CH6
PE4			PE4	PA4			PA4	CH5
					PA3	PA3		CH4
				PA2			PA2	CH3
	PE1	PE1			PA1	PA1		CH2
PE0			PE0	PA0			PA0	CH1
								CH0

Table 5.26. ADC0 Bus and Pin Mapping

APORT4Y	APORT4X	APORT3Y	APORT3X	APORT2Y	APORT2X	APORT1Y	APORT1X	APORT0Y	APORT0X	Port Bus
BUSDY	BUSDX	BUSCY	BUSCX	BUSBY	BUSBX	BUSAY	BUSAX	BUSADC0Y	BUSADC0X	CH31
PF14			PF14	PB14		PB15	PB14			CH30
	PF13	PF13			PB13	PB13				CH29
PF12			PF12	PB12		PB11	PB12			CH28
	PF11	PF11			PB11	PB11				CH27
PF10			PF10	PB10			PB10			CH26
	PF9	PF9			PB9	PB9				CH25
PF8			PF8							CH24
	PF7	PF7								CH23
PF6			PF6	PB6			PB6			CH22
	PF5	PF5			PB5	PB5				CH21
PF4			PF4	PB4			PB4			CH20
	PF3	PF3			PB3	PB3				CH19
PF2			PF2	PB2			PB2			CH18
	PF1	PF1			PB1	PB1				CH17
PF0			PF0	PB0			PB0			CH16
	PE15	PE15			PA15	PA15				CH15
PE14			PE14	PA14			PA14			CH14
	PE13	PE13			PA13	PA13				CH13
PE12			PE12	PA12			PA12			CH12
	PE11	PE11			PA11	PA11				CH11
PE10			PE10	PA10			PA10			CH10
	PE9	PE9			PA9	PA9				CH9
PE8			PE8	PA8			PA8			CH8
	PE7	PE7			PA7	PA7		PD7	PD7	CH7
PE6			PE6	PA6			PA6	PD6	PD6	CH6
	PE5	PE5			PA5	PA5		PD5	PD5	CH5
PE4			PE4	PA4			PA4	PD4	PD4	CH4
					PA3	PA3		PD3	PD3	CH3
				PA2			PA2	PD2	PD2	CH2
	PE1	PE1			PA1	PA1		PD1	PD1	CH1
PE0			PE0	PA0			PA0	PD0	PD0	CH0

Table 5.27. ADC1 Bus and Pin Mapping

APORT4Y	APORT4X	APORT3Y	APORT3X	APORT2Y	APORT2X	APORT1Y	APORT1X	Port
BUSDY	BUSDX	BUSCY	BUSCX	BUSBY	BUSBX	BUSAY	BUSAX	Bus
PF14			PF14	PB14	PB15	PB15	PB14	CH31
	PF13	PF13			PB13	PB13		CH30
PF12			PF12	PB12			PB12	CH29
	PF11	PF11			PB11	PB11		CH28
PF10			PF10	PB10			PB10	CH27
	PF9	PF9			PB9	PB9		CH26
PF8			PF8					CH25
	PF7	PF7						CH24
PF6			PF6	PB6			PB6	CH23
	PF5	PF5			PB5	PB5		CH22
PF4			PF4	PB4			PB4	CH21
	PF3	PF3			PB3	PB3		CH20
PF2			PF2	PB2			PB2	CH19
	PF1	PF1			PB1	PB1		CH18
PF0			PF0	PB0			PB0	CH17
	PE15	PE15			PA15	PA15		CH16
PE14			PE14	PA14			PA14	CH15
	PE13	PE13			PA13	PA13		CH14
PE12			PE12	PA12			PA12	CH13
	PE11	PE11			PA11	PA11		CH12
PE10			PE10	PA10			PA10	CH11
	PE9	PE9			PA9	PA9		CH10
PE8			PE8	PA8			PA8	CH9
	PE7	PE7			PA7	PA7		CH8
PE6			PE6	PA6			PA6	CH7
	PE5	PE5			PA5	PA5		CH6
PE4			PE4	PA4			PA4	CH5
					PA3	PA3		CH4
				PA2			PA2	CH3
	PE1	PE1			PA1	PA1		CH2
PE0			PE0	PA0			PA0	CH1
								CH0

Table 5.30. VDAC0 / OPA Bus and Pin Mapping

Port	Bus	CH31	CH30	CH29	CH28	CH27	CH26	CH25	CH24	CH23	CH22	CH21	CH20	CH19	CH18	CH17	CH16	CH15	CH14	CH13	CH12	CH11	CH10	CH9	CH8	CH7	CH6	CH5	CH4	CH3	CH2	CH1	CH0	
OPA0_N																																		
APORT1Y	BUSAY	PB15		PB13		PB11		PB9				PB5		PB3		PB1		PA15		PA13		PA11		PA9		PA7		PA5		PA3		PA1		
APORT2Y	BUSBY		PB14		PB12		PB10				PB6		PB4		PB2		PB0		PA14		PA12		PA10		PA8		PA6		PA4		PA2		PA0	
APORT3Y	BUSCY			PF13		PF11		PF9		PF7		PF5		PF3		PF1		PE15		PE13		PE11		PE9		PE7		PE5				PE1		
APORT4Y	BUSDY		PF14		PF12		PF10		PF8		PF6		PF4		PF2		PF0		PE14		PE12		PE10		PE8		PE6		PE4				PE0	
OPA0_P																																		
APORT1X	BUSAX		PB14		PB12		PB10					PB6		PB4		PB2		PA15		PA13		PA11		PA9		PA7		PA5		PA3		PA1		
APORT2X	BUSBX	PB15		PB13		PB11		PB9				PB5		PB3		PB1		PA15		PA13		PA11		PA9		PA7		PA5		PA3		PA1		
APORT3X	BUSCX		PF14		PF12		PF10		PF8		PF6		PF4		PF2		PF0		PE14		PE12		PE10		PE8		PE6		PE4				PE0	
APORT4X	BUSDX		PF13		PF11		PF9		PF7		PF5		PF3		PF1		PF0		PE15		PE13		PE11		PE9		PE7		PE5				PE1	

Port	Bus	CH31	CH30	CH29	CH28	CH27	CH26	CH25	CH24	CH23	CH22	CH21	CH20	CH19	CH18	CH17	CH16	CH15	CH14	CH13	CH12	CH11	CH10	CH9	CH8	CH7	CH6	CH5	CH4	CH3	CH2	CH1	CH0
VDAC0_OUT1 / OPA1_OUT																																	
APORT4Y	BUSDY		PF14		PF12		PF10		PF8		PF6		PF4		PF2		PF0		PE14		PE12		PE10		PE8		PE6		PE4			PE0	
APORT3Y	BUSCY			PF13		PF11		PF9		PF7		PF5		PF3		PF1		PE15		PE13		PE11		PE9		PE7		PE5					
APORT2Y	BUSBY		PB14		PB12		PB10				PB6		PB4		PB2		PB0		PA14		PA12		PA10		PA8		PA6		PA4		PA2		PA0
APORT1Y	BUSAY	PB15		PB13		PB11		PB9				PB5		PB3		PB1		PA15		PA13		PA11		PA9		PA7		PA5		PA3		PA1	

6. BGA120 Package Specifications

6.1 BGA120 Package Dimensions

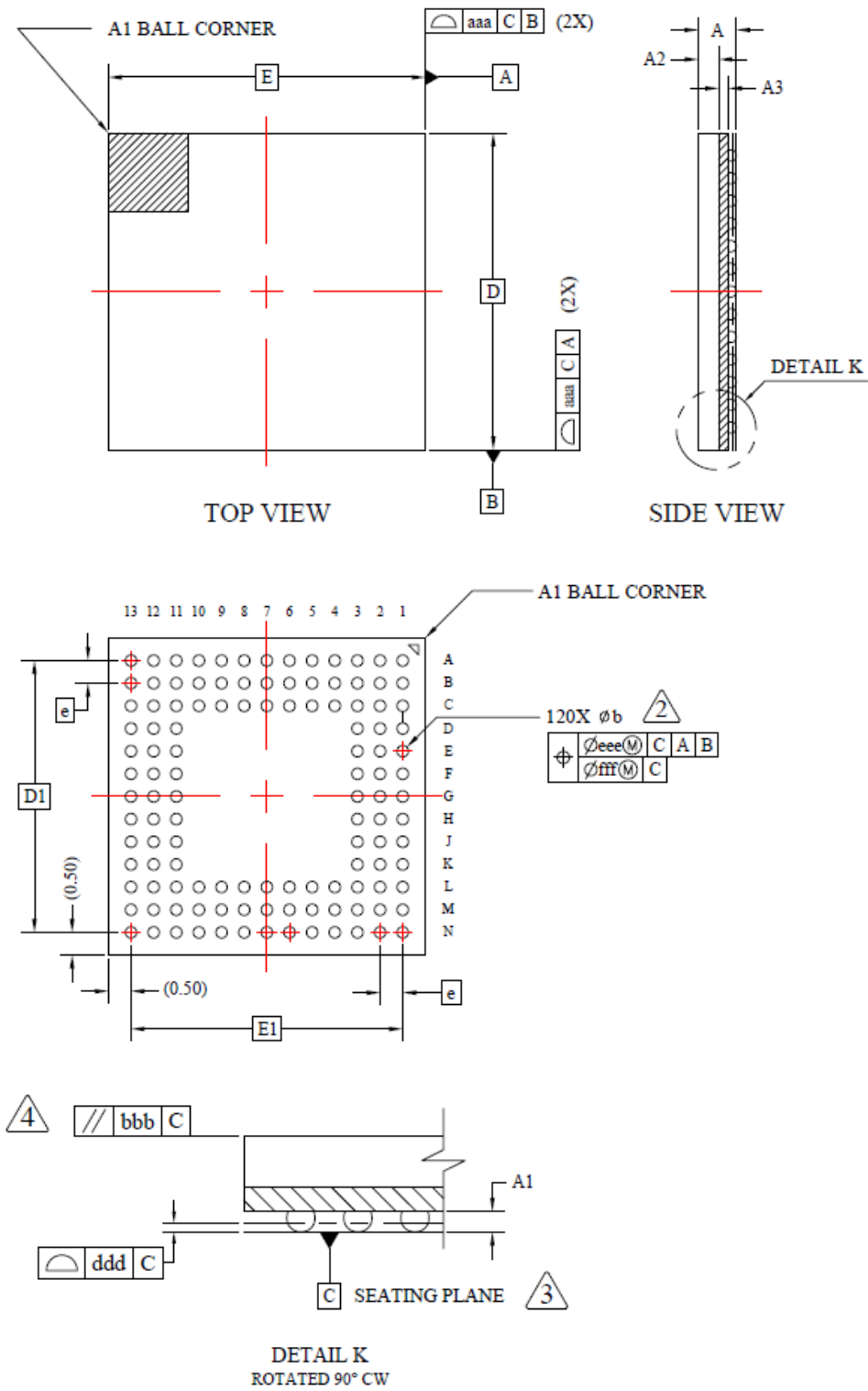

Table 6.1. BGA120 Package Dimensions

Dimension	Min	Typ	Max
A	0.78	0.84	0.90
A1	0.13	0.18	0.23
A3	0.17	0.21	0.25
A2	0.45 REF		
D	7.00 BSC		
e	0.50 BSC		
E	7.00 BSC		
D1	6.00 BSC		
E1	6.00 BSC		
b	0.20	0.25	0.30
aaa	0.10		
bbb	0.10		
ddd	0.08		
eee	0.15		
fff	0.05		

Note:

1. All dimensions shown are in millimeters (mm) unless otherwise noted.
2. Dimensioning and Tolerancing per ANSI Y14.5M-1994.
3. Recommended card reflow profile is per the JEDEC/IPC J-STD-020 specification for Small Body Components.

6.2 BGA120 PCB Land Pattern

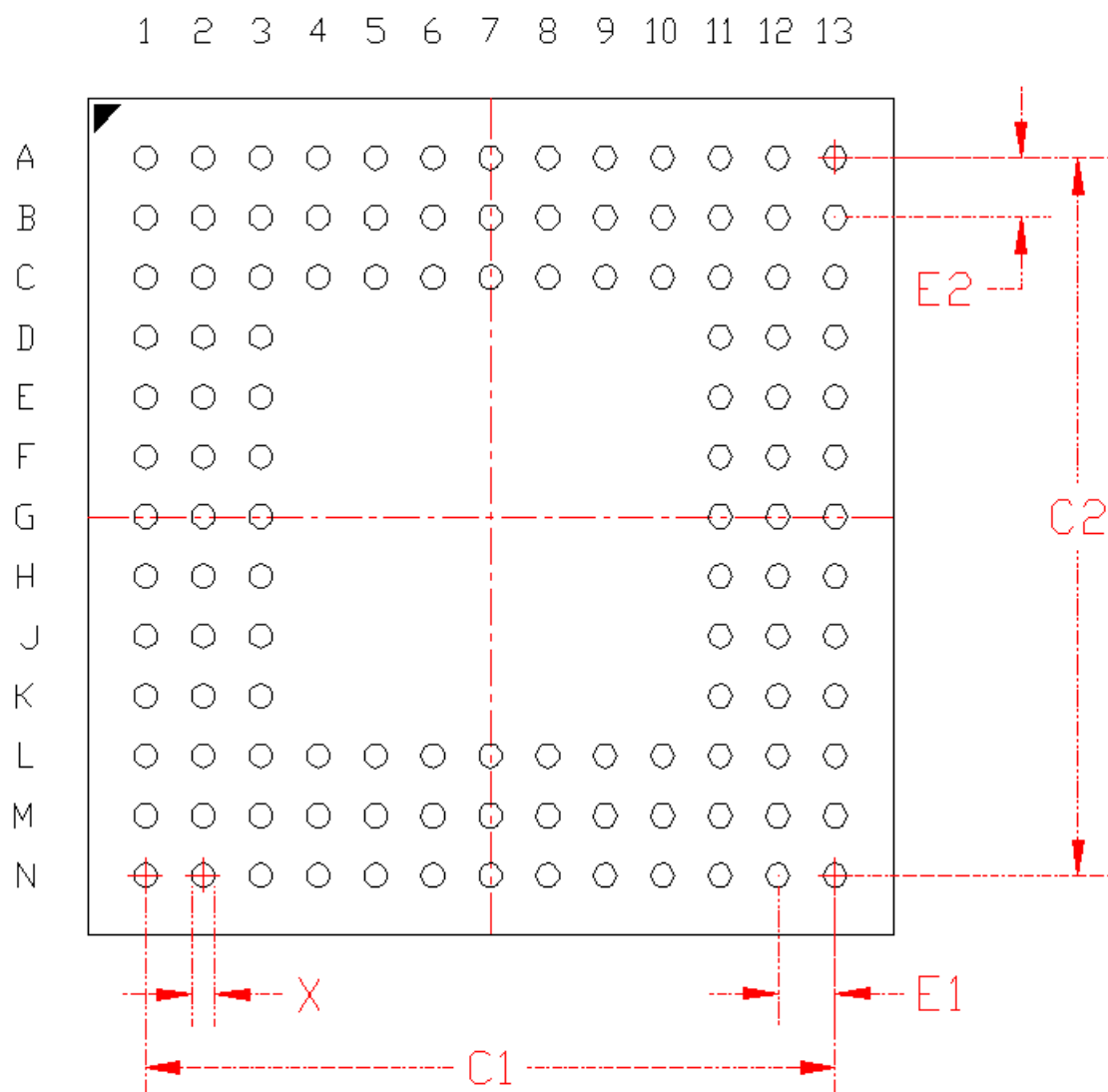

Figure 6.2. BGA120 PCB Land Pattern Drawing

Table 6.2. BGA120 PCB Land Pattern Dimensions

Dimension	Min	Nom	Max
X		0.20	
C1		6.00	
C2		6.00	
E1		0.5	
E2		0.5	

Note:

1. All dimensions shown are in millimeters (mm) unless otherwise noted.
2. Dimensioning and Tolerancing is per the ANSI Y14.5M-1994 specification.
3. This Land Pattern Design is based on the IPC-7351 guidelines.
4. All metal pads are to be non-solder mask defined (NSMD). Clearance between the solder mask and the metal pad is to be 60 µm minimum, all the way around the pad.
5. A stainless steel, laser-cut and electro-polished stencil with trapezoidal walls should be used to assure good solder paste release.
6. The stencil thickness should be 0.125 mm (5 mils).
7. The ratio of stencil aperture to land pad size should be 1:1.
8. A No-Clean, Type-3 solder paste is recommended.
9. The recommended card reflow profile is per the JEDEC/IPC J-STD-020C specification for Small Body Components.

6.3 BGA120 Package Marking



Figure 6.3. BGA120 Package Marking

The package marking consists of:

- P P P P P P P P P P – The part number designation.
- T T T T T T – A trace or manufacturing code. The first letter is the device revision.
- Y Y – The last 2 digits of the assembly year.
- W W – The 2-digit workweek when the device was assembled.

7. BGA112 Package Specifications

7.1 BGA112 Package Dimensions



Figure 7.1. BGA112 Package Drawing

Table 7.1. BGA112 Package Dimensions

Dimension	Min	Typ	Max
A	-	-	1.30
A1	0.55	0.60	0.65
A2	0.21 BSC		
A3	0.30	0.35	0.40
d	0.43	0.48	0.53
D	10.00 BSC		
D1	8.00 BSC		
E	10.00 BSC		
E1	8.00 BSC		
e1	0.80 BSC		
e2	0.80 BSC		
L1	1.00 REF		
L2	1.00 REF		

Note:

1. All dimensions shown are in millimeters (mm) unless otherwise noted.
2. Dimensioning and Tolerancing per ANSI Y14.5M-1994.
3. Recommended card reflow profile is per the JEDEC/IPC J-STD-020 specification for Small Body Components.

7.2 BGA112 PCB Land Pattern



Figure 7.2. BGA112 PCB Land Pattern Drawing

Table 7.2. BGA112 PCB Land Pattern Dimensions

Dimension	Min	Nom	Max
X		0.45	
C1		8.00	
C2		8.00	
E1		0.8	
E2		0.8	

Note:

1. All dimensions shown are in millimeters (mm) unless otherwise noted.
2. Dimensioning and Tolerancing is per the ANSI Y14.5M-1994 specification.
3. This Land Pattern Design is based on the IPC-7351 guidelines.
4. All metal pads are to be non-solder mask defined (NSMD). Clearance between the solder mask and the metal pad is to be 60 µm minimum, all the way around the pad.
5. A stainless steel, laser-cut and electro-polished stencil with trapezoidal walls should be used to assure good solder paste release.
6. The stencil thickness should be 0.125 mm (5 mils).
7. The ratio of stencil aperture to land pad size should be 1:1.
8. A No-Clean, Type-3 solder paste is recommended.
9. The recommended card reflow profile is per the JEDEC/IPC J-STD-020C specification for Small Body Components.

7.3 BGA112 Package Marking



Figure 7.3. BGA112 Package Marking

The package marking consists of:

- P – The part number designation.
- T – A trace or manufacturing code. The first letter is the device revision.
- Y – The last 2 digits of the assembly year.
- W – The 2-digit workweek when the device was assembled.

8. TQFP100 Package Specifications

8.1 TQFP100 Package Dimensions



Figure 8.1. TQFP100 Package Drawing

Table 8.1. TQFP100 Package Dimensions

Dimension	Min	Typ	Max
A	-	-	1.20
A1	0.05	-	0.15
A2	0.95	1.00	1.05
b	0.17	0.22	0.27
b1	0.17	0.20	0.23
c	0.09	-	0.20
c1	0.09	-	0.16
D	16.0 BSC		
E	16.0 BSC		
D1	14.0 BSC		
E1	14.0 BSC		
e	0.50 BSC		
L1	1 REF		
L	0.45	0.60	0.75
θ	0	3.5	7
θ1	0	-	-
θ2	11	12	13
θ3	11	12	13
R1	0.08	-	-
R2	0.08	-	0.2
S	0.2	-	-
aaa	0.2		
bbb	0.2		
ccc	0.08		
ddd	0.08		
eee	0.05		

Note:

1. All dimensions shown are in millimeters (mm) unless otherwise noted.
2. Dimensioning and Tolerancing per ANSI Y14.5M-1994.
3. Recommended card reflow profile is per the JEDEC/IPC J-STD-020 specification for Small Body Components.

8.2 TQFP100 PCB Land Pattern



Figure 8.2. TQFP100 PCB Land Pattern Drawing

Table 8.2. TQFP100 PCB Land Pattern Dimensions

Dimension	Min	Nom	Max
C1		15.4	
C2		15.4	
E		0.50 BSC	
X		0.30	
Y		1.50	

Note:

1. All dimensions shown are in millimeters (mm) unless otherwise noted.
2. This Land Pattern Design is based on the IPC-7351 guidelines.
3. All metal pads are to be non-solder mask defined (NSMD). Clearance between the solder mask and the metal pad is to be 60 µm minimum, all the way around the pad.
4. A stainless steel, laser-cut and electro-polished stencil with trapezoidal walls should be used to assure good solder paste release.
5. The stencil thickness should be 0.125 mm (5 mils).
6. The ratio of stencil aperture to land pad size should be 1:1 for all perimeter pads.
7. A No-Clean, Type-3 solder paste is recommended.
8. The recommended card reflow profile is per the JEDEC/IPC J-STD-020C specification for Small Body Components.

8.3 TQFP100 Package Marking



Figure 8.3. TQFP100 Package Marking

The package marking consists of:

- P P P P P P P P P P – The part number designation.
- T T T T T T – A trace or manufacturing code. The first letter is the device revision.
- Y Y – The last 2 digits of the assembly year.
- W W – The 2-digit workweek when the device was assembled.

9. TQFP64 Package Specifications

9.1 TQFP64 Package Dimensions



Figure 9.1. TQFP64 Package Drawing

Table 9.1. TQFP64 Package Dimensions

Dimension	Min	Typ	Max
A	—	1.15	1.20
A1	0.05	—	0.15
A2	0.95	1.00	1.05
b	0.17	0.22	0.27
b1	0.17	0.20	0.23
c	0.09	—	0.20
c1	0.09	—	0.16
D	12.00 BSC		
D1	10.00 BSC		
e	0.50 BSC		
E	12.00 BSC		
E1	10.00 BSC		
L	0.45	0.60	0.75
L1	1.00 REF		
R1	0.08	—	—
R2	0.08	—	0.20
S	0.20	—	—
θ	0	3.5	7
θ1	0	—	0.10
θ2	11	12	13
θ3	11	12	13

Note:

1. All dimensions shown are in millimeters (mm) unless otherwise noted.
2. Dimensioning and Tolerancing per ANSI Y14.5M-1994.
3. Recommended card reflow profile is per the JEDEC/IPC J-STD-020 specification for Small Body Components.

9.2 TQFP64 PCB Land Pattern

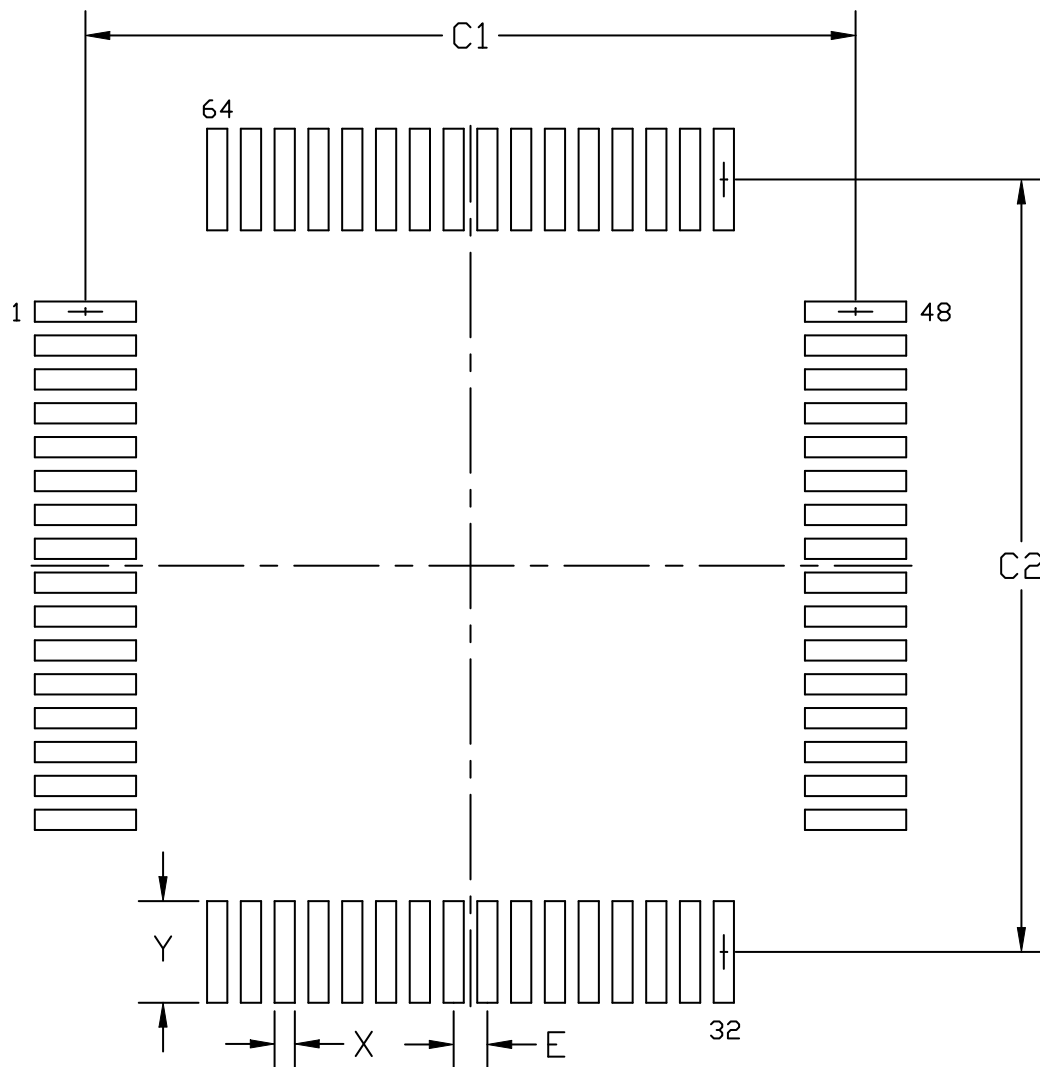

Figure 9.2. TQFP64 PCB Land Pattern Drawing

Table 9.2. TQFP64 PCB Land Pattern Dimensions

Dimension	Min	Max
C1	11.30	11.40
C2	11.30	11.40
E	0.50 BSC	
X	0.20	0.30
Y	1.40	1.50

Note:

1. All dimensions shown are in millimeters (mm) unless otherwise noted.
2. This Land Pattern Design is based on the IPC-7351 guidelines.
3. All metal pads are to be non-solder mask defined (NSMD). Clearance between the solder mask and the metal pad is to be 60 μm minimum, all the way around the pad.
4. A stainless steel, laser-cut and electro-polished stencil with trapezoidal walls should be used to assure good solder paste release.
5. The stencil thickness should be 0.125 mm (5 mils).
6. The ratio of stencil aperture to land pad size can be 1:1 for all pads.
7. A No-Clean, Type-3 solder paste is recommended.
8. The recommended card reflow profile is per the JEDEC/IPC J-STD-020 specification for Small Body Components.

9.3 TQFP64 Package Marking



Figure 9.3. TQFP64 Package Marking

The package marking consists of:

- P P P P P P P P P P – The part number designation.
- T T T T T T – A trace or manufacturing code. The first letter is the device revision.
- Y Y – The last 2 digits of the assembly year.
- W W – The 2-digit workweek when the device was assembled.

10. QFN64 Package Specifications

10.1 QFN64 Package Dimensions



Figure 10.1. QFN64 Package Drawing

Table 10.1. QFN64 Package Dimensions

Dimension	Min	Typ	Max
A	0.70	0.75	0.80
A1	0.00	—	0.05
b	0.20	0.25	0.30
A3	0.203 REF		
D	9.00 BSC		
e	0.50 BSC		
E	9.00 BSC		
D2	7.10	7.20	7.30
E2	7.10	7.20	7.30
L	0.40	0.45	0.50
L1	0.00	—	0.10
aaa	0.10		
bbb	0.10		
ccc	0.10		
ddd	0.05		
eee	0.08		

Note:

1. All dimensions shown are in millimeters (mm) unless otherwise noted.
2. Dimensioning and Tolerancing per ANSI Y14.5M-1994.
3. Recommended card reflow profile is per the JEDEC/IPC J-STD-020 specification for Small Body Components.

10.2 QFN64 PCB Land Pattern



Figure 10.2. QFN64 PCB Land Pattern Drawing

Table 10.2. QFN64 PCB Land Pattern Dimensions

Dimension	Typ
C1	8.90
C2	8.90
E	0.50
X1	0.30
Y1	0.85
X2	7.30
Y2	7.30

Note:

1. All dimensions shown are in millimeters (mm) unless otherwise noted.
2. This Land Pattern Design is based on the IPC-7351 guidelines.
3. All dimensions shown are at Maximum Material Condition (MMC). Least Material Condition (LMC) is calculated based on a Fabrication Allowance of 0.05mm.
4. All metal pads are to be non-solder mask defined (NSMD). Clearance between the solder mask and the metal pad is to be 60 µm minimum, all the way around the pad.
5. A stainless steel, laser-cut and electro-polished stencil with trapezoidal walls should be used to assure good solder paste release.
6. The stencil thickness should be 0.125 mm (5 mils).
7. The ratio of stencil aperture to land pad size can be 1:1 for all pads.
8. A 3x3 array of 1.45 mm square openings on a 2.00 mm pitch can be used for the center ground pad.
9. A No-Clean, Type-3 solder paste is recommended.
10. The recommended card reflow profile is per the JEDEC/IPC J-STD-020 specification for Small Body Components.

10.3 QFN64 Package Marking



Figure 10.3. QFN64 Package Marking

The package marking consists of:

- P P P P P P P P P P – The part number designation.
- T T T T T T – A trace or manufacturing code. The first letter is the device revision.
- Y Y – The last 2 digits of the assembly year.
- W W – The 2-digit workweek when the device was assembled.

11. Revision History

Revision 1.0

July, 2019

- [4.1 Electrical Characteristics](#) updated with final production test limits.
- RESETn pin pullup connection to AVDD clarified in pinout tables.
- [Table 5.20 GPIO Functionality Table on page 166](#) formatting updated for translation.

Revision 0.6

February, 2019

- Updated [2. Ordering Information](#) with new high temperature range BGA part numbers.
- [4.1 Electrical Characteristics](#) updated with notes distinguishing RESETn reference (AVDD) from all other GPIO reference (IOVDD).
- Added to pin description of DECOUPLE - decouple output for on-chip voltage should not be used to power external circuits.
- [5.20 GPIO Functionality Table](#): re-ordered to show pins in alphabetical order by GPIO name.

Revision 0.5

December, 2018

- [4.1 Electrical Characteristics](#) updated with latest characterization data and production test limits.
- [4.1 Electrical Characteristics](#) added SDIO location 1 and SDIO SPI mode timing details.
- [4.1 Electrical Characteristics](#) sorted all table footnotes in order of appearance.
- [Table 5.21 Alternate Functionality Overview on page 178](#) changed vertical white space.

Revision 0.1

May, 2018

Initial release.

Silicon Labs

Simplicity Studio™4



Simplicity Studio

One-click access to MCU and wireless tools, documentation, software, source code libraries & more. Available for Windows, Mac and Linux!



IoT Portfolio
www.silabs.com/IoT



SW/HW
www.silabs.com/simplicity



Quality
www.silabs.com/quality



Support and Community
community.silabs.com

Disclaimer

Silicon Labs intends to provide customers with the latest, accurate, and in-depth documentation of all peripherals and modules available for system and software implementers using or intending to use the Silicon Labs products. Characterization data, available modules and peripherals, memory sizes and memory addresses refer to each specific device, and "Typical" parameters provided can and do vary in different applications. Application examples described herein are for illustrative purposes only. Silicon Labs reserves the right to make changes without further notice to the product information, specifications, and descriptions herein, and does not give warranties as to the accuracy or completeness of the included information. Without prior notification, Silicon Labs may update product firmware during the manufacturing process for security or reliability reasons. Such changes will not alter the specifications or the performance of the product. Silicon Labs shall have no liability for the consequences of use of the information supplied in this document. This document does not imply or expressly grant any license to design or fabricate any integrated circuits. The products are not designed or authorized to be used within any FDA Class III devices, applications for which FDA premarket approval is required or Life Support Systems without the specific written consent of Silicon Labs. A "Life Support System" is any product or system intended to support or sustain life and/or health, which, if it fails, can be reasonably expected to result in significant personal injury or death. Silicon Labs products are not designed or authorized for military applications. Silicon Labs products shall under no circumstances be used in weapons of mass destruction including (but not limited to) nuclear, biological or chemical weapons, or missiles capable of delivering such weapons. Silicon Labs disclaims all express and implied warranties and shall not be responsible or liable for any injuries or damages related to use of a Silicon Labs product in such unauthorized applications.

Trademark Information

Silicon Laboratories Inc.®, Silicon Laboratories®, Silicon Labs®, SiLabs® and the Silicon Labs logo®, Bluegiga®, Bluegiga Logo®, ClockBuilder®, CMEMS®, DSPLL®, EFM®, EFM32®, EFR, Ember®, Energy Micro, Energy Micro logo and combinations thereof, "the world's most energy friendly microcontrollers", Ember®, EZLink®, EZRadio®, EZRadioPRO®, Gecko®, Gecko OS, Gecko OS Studio, ISOModem®, Precision32®, ProSLIC®, Simplicity Studio®, SiPHY®, Telegesis, the Telegesis Logo®, USBXpress®, Zentri, the Zentri logo and Zentri DMS, Z-Wave®, and others are trademarks or registered trademarks of Silicon Labs. ARM, CORTEX, Cortex-M3 and THUMB are trademarks or registered trademarks of ARM Holdings. Keil is a registered trademark of ARM Limited. Wi-Fi is a registered trademark of the Wi-Fi Alliance. All other products or brand names mentioned herein are trademarks of their respective holders.



Silicon Laboratories Inc.
400 West Cesar Chavez
Austin, TX 78701
USA

<http://www.silabs.com>