

Product Description

The PE42421 UltraCMOS® RF switch is designed to cover a broad range of applications from 10 MHz through 3000 MHz. This reflective switch integrates on-board CMOS control logic with a low voltage CMOS-compatible control interface, and can be controlled using either single-pin or complementary control inputs. Using a nominal +3-volt power supply voltage, a typical input 1 dB compression point of +33.5 dBm can be achieved.

The PE42421 SPDT RF switch is manufactured on Peregrine's UltraCMOS® process, a patented variation of silicon-on-insulator (SOI) technology on a sapphire substrate, offering the performance of GaAs with the economy and integration of conventional CMOS.

Features

- Single-pin or complementary CMOS logic control inputs
- Low insertion loss: 0.35 dB at 1000 MHz, 0.5 dB at 2000 MHz
- Isolation of 30 dB at 1000 MHz, 20 dB at 2000 MHz
- Typical input 1 dB compression point of +33.5 dBm
- 1.8V minimum power supply voltage
- SC-70 package

Figure 1. Functional Diagram

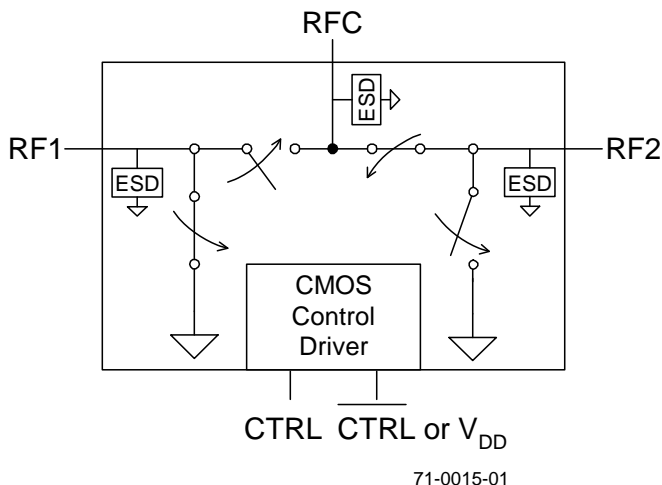

Figure 2. Package

6-lead SC-70



Table 1. Electrical Specifications @ +25°C, V_{DD} = 3V (Z_S = Z_L = 50Ω)

Parameter	Condition	Minimum	Typical	Maximum	Unit
Operation Frequency ¹		10 MHz		3000	MHz
Insertion Loss ³	1000 MHz		0.35	0.45	dB
	2000 MHz		0.50	0.60	dB
Isolation	1000 MHz	29	30		dB
	2000 MHz	19	20		dB
Return Loss ³	1000 MHz	21	22		dB
	2000 MHz	24	27		dB
'ON' Switching Time	50% CTRL to 0.1 dB of final value, 1 GHz		1.50		us
'OFF' Switching Time	50% CTRL to 25 dB isolation, 1 GHz		1.50		us
Video Feedthrough ²			15		mV _{pp}
Input 1 dB Compression	1000 MHz @ 2.3 - 3.3V	31.5	33.5		dBm
	1000 MHz @ 1.8 - 2.3V	29.5	30.5		
	2500 MHz @ 2.3 - 3.3V	28.5	30.5		
	2500 MHz @ 1.8 - 2.3V	28	29		
Input IP3	1000 MHz, 20dBm input power		55		dBm

- Notes:
1. Device linearity will begin to degrade below 10 MHz
 2. The DC transient at the output of any port of the switch when the control voltage is switched from Low to High or High to Low in a 50Ω test set-up, measured with 1ns risetime pulses and 500 MHz bandwidth
 3. A tuning capacitor must be added to the application board to optimize the insertion loss and return loss performance. See *Figure 6* for details

Figure 3. Pin Configuration (Top View)

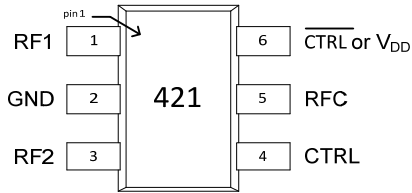

Table 2. Pin Descriptions

Pin No.	Pin Name	Description
1	RF1 ⁴	RF Port1
2	GND	Ground connection. Traces should be physically short and connected to ground plane for best performance.
3	RF2 ⁴	RF Port2
4	CTRL	Switch control input, CMOS logic level.
5	RFC ⁴	RF Common
6	CTRL or V _{DD}	This pin supports two interface options: <i>Single-pin control mode.</i> A nominal 3-volt supply connection is required. <i>Complementary-pin control mode.</i> A complementary CMOS control signal to CTRL is supplied to this pin. Bypassing on this pin is not required in this mode.

Note: 4. All RF pins must be DC blocked with an external series capacitor or held at 0 V_{DC}

Table 3. Operating Ranges

Parameter	Min	Typ	Max	Unit
V _{DD} Power Supply Voltage	1.8	3.0	3.3	V
I _{DD} Power Supply Current (V _{DD} = 3V, V _{CTRL} = 3V)		9	20	μA
Control Voltage High	0.7x V _{DD}			V
Control Voltage Low			0.3x V _{DD}	V

Moisture Sensitivity Level

The Moisture Sensitivity Level rating for the PE42421 in the SC70 package is MSL1.

Switching Frequency

The PE42421 has a maximum 25 kHz switching rate.

Table 4. Absolute Maximum Ratings

Symbol	Parameter/Condition	Min	Max	Unit
V _{DD}	Power supply voltage	-0.3	4.0	V
V _I	Voltage on any DC input	-0.3	V _{DD} +0.3	V
T _{ST}	Storage temperature range	-65	150	°C
T _{OP}	Operating temperature range	-40	85	°C
P _{IN}	Input power (50 Ω)		+34 ⁵	dBm
V _{ESD}	ESD Voltage (HBM, ML_STD 883 Method 3015.7)		2000	V
	ESD Voltage (MM, JEDEC, JESD22-A114-B)		100	V

Notes: 5. To maintain optimum device performance, do not exceed Max P_{IN} at desired operating frequency (see Figure 4)

Exceeding absolute maximum ratings may cause permanent damage. Operation should be restricted to the limits in the Operating Ranges table. Operation between operating range maximum and absolute maximum for extended periods may reduce reliability.

Figure 4. Maximum Input Power

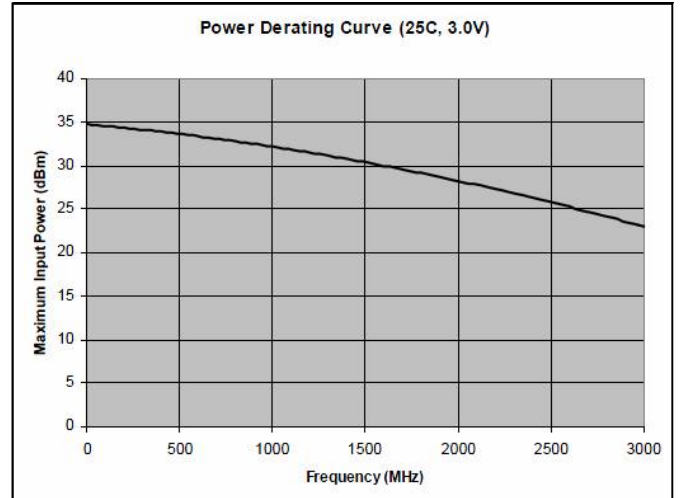

Latch-Up Avoidance

Unlike conventional CMOS devices, UltraCMOS[®] devices are immune to latch-up.

Electrostatic Discharge (ESD) Precautions

When handling this UltraCMOS[®] device, observe the same precautions that you would use with other ESD-sensitive devices. Although this device contains circuitry to protect it from damage due to ESD, precautions should be taken to avoid exceeding the specified rating.

Table 5. Single-pin Control Logic Truth Table

Control Voltages	Signal Path
Pin 6 (V_{DD}) = V_{DD} Pin 4 (CTRL) = High	RFC to RF2
Pin 6 (V_{DD}) = V_{DD} Pin 4 (CTRL) = Low	RFC to RF1

Table 6. Complementary-pin Control Logic Truth Table

Control Voltages	Signal Path
Pin 6 (\overline{CTRL} or V_{DD}) = Low Pin 4 (CTRL) = High	RFC to RF2
Pin 6 (\overline{CTRL} or V_{DD}) = High Pin 4 (CTRL) = Low	RFC to RF1

Control Logic Input

The PE42421 is a versatile RF CMOS switch that supports two operating control modes; single-pin control mode and complementary-pin control mode.

Single-pin control mode enables the switch to operate with a single control pin (pin 4) supporting a +3-volt CMOS logic input, and requires a dedicated +3-volt power supply connection on pin 6 (V_{DD}). This mode of operation reduces the number of control lines required and simplifies the switch control interface typically derived from a CMOS μ Processor I/O port.

Complementary-pin control mode allows the switch to operate using complementary control pins CTRL and \overline{CTRL} (pins 4 & 6), that can be directly driven by +3-volt CMOS logic or a suitable μ Processor I/O port. This enables the PE42421 to be used as a potential alternate source for SPDT RF switch products used in positive control voltage mode and operating within the PE42421 operating limits.

Evaluation Kit

The SPDT switch EK Board was designed to ease customer evaluation of Peregrine’s PE42421. The RF common port is connected through a 50Ω transmission line via the top SMA connector, J1. RF1 and RF2 are connected through 50Ω transmission lines via SMA connectors J2 and J3, respectively. A through 50Ω transmission is available via SMA connectors J4 and J5. This transmission line can be used to estimate the loss of the PCB over the environmental conditions being evaluated.

The board is constructed of a two metal layer FR4 material with a total thickness of 0.031”. The bottom layer provides ground for the RF transmission lines. The transmission lines were designed using a coplanar waveguide with ground plane model using a trace width of 0.0476”, trace gaps of 0.030”, dielectric thickness of 0.028”, metal thickness of 0.0021” and ϵ_r of 4.4.

J6 and J7 provide a means for controlling DC and digital inputs to the device. J6-1 is connected to the device V_{DD} or CTRL input. J7-1 is connected to the device CTRL input.

Figure 5. Evaluation Board Layouts

Peregrine Specification 101-0162-02

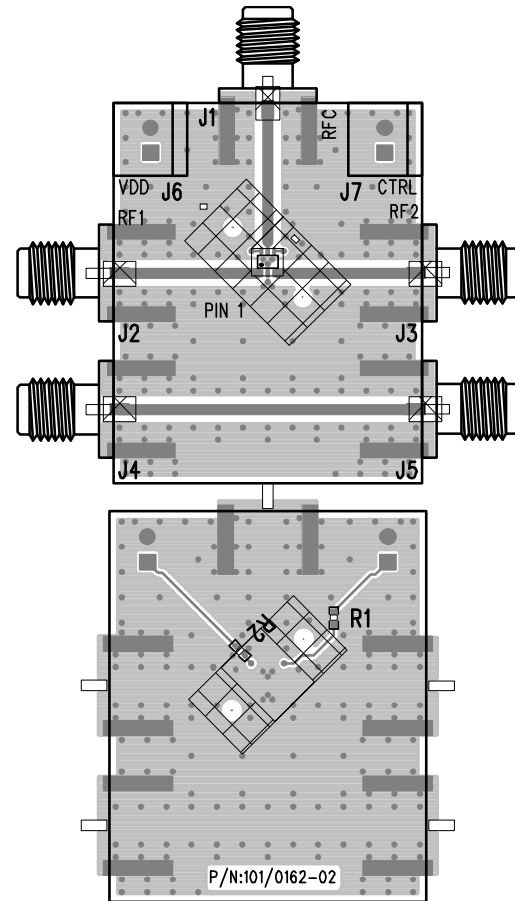
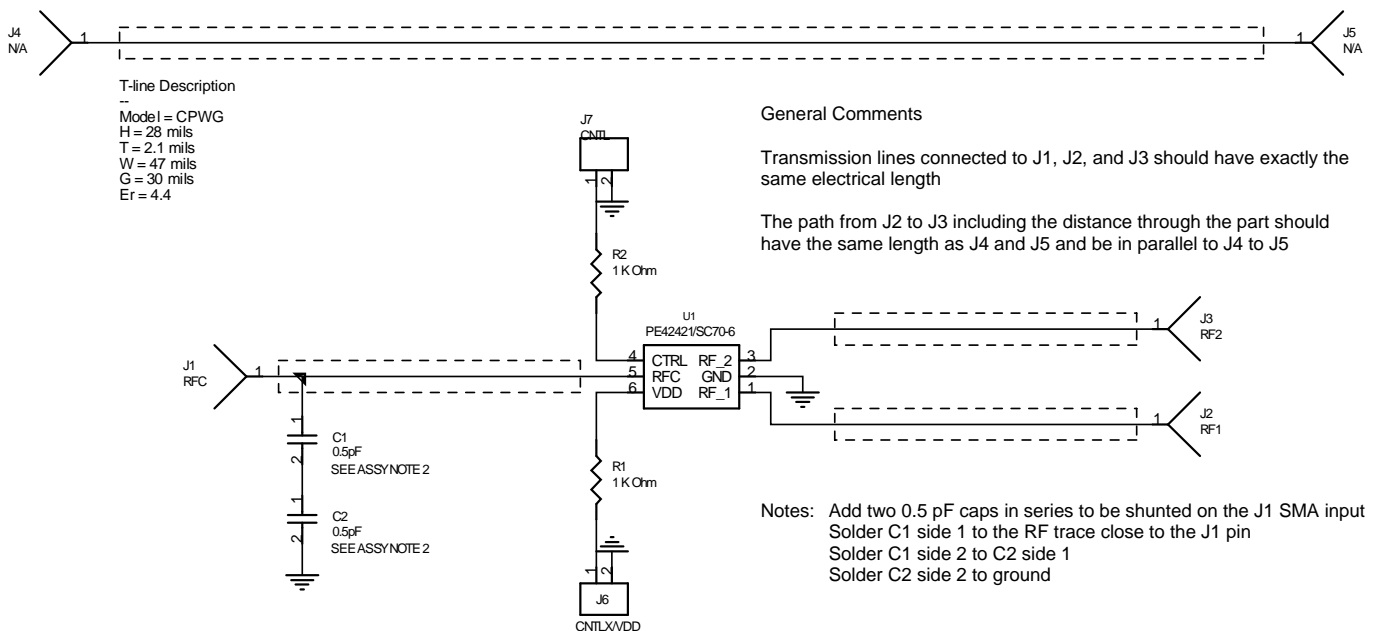

Figure 6. Evaluation Board Schematic

Peregrine Specification 102-0756-01



Typical Performance Data @ -40°C to 85°C (Unless Otherwise Noted)

Figure 7. Insertion Loss

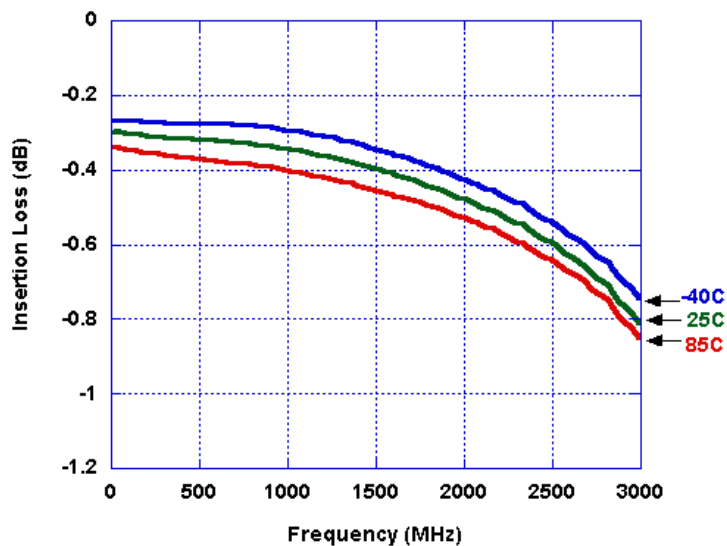

Figure 8. Isolation – Input to Output

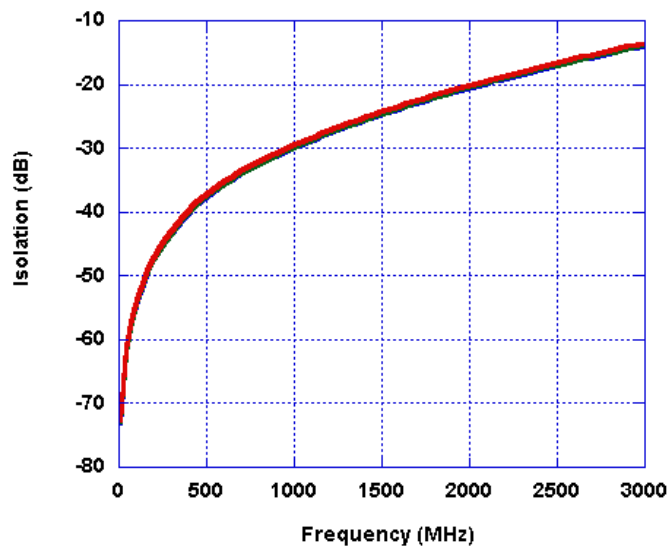

Figure 9. Isolation – Output to Output

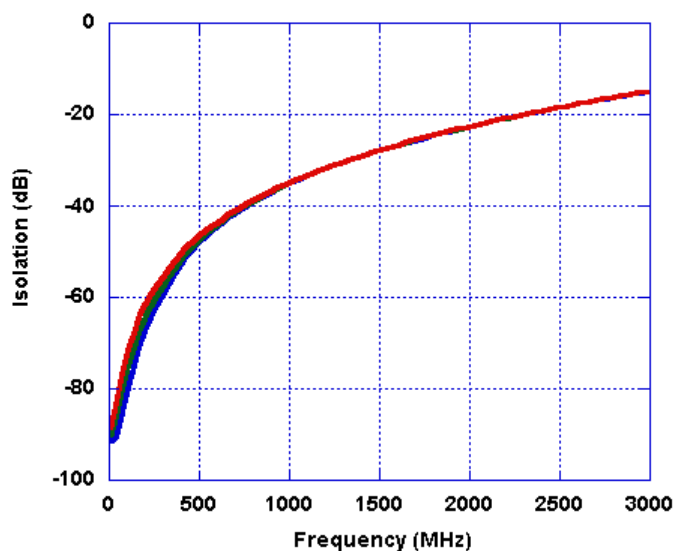
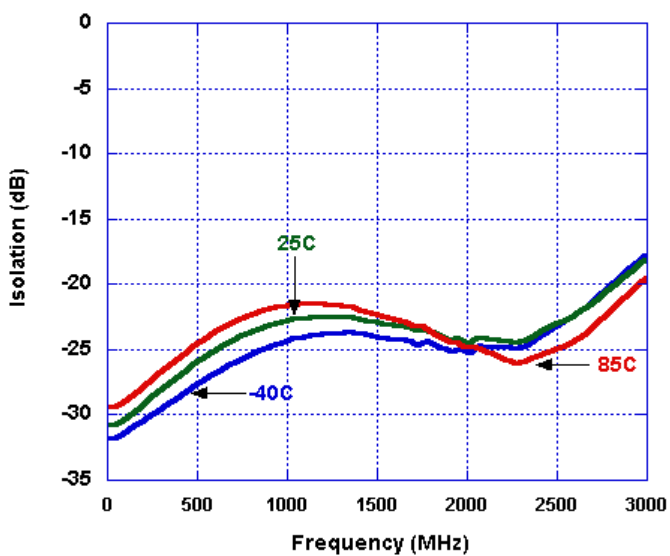

Figure 10. Return Loss (Input)



Typical Performance Data @ $V_{DD} = 2.3V$, $T = 25^{\circ}C$

Figure 11. Insertion Loss

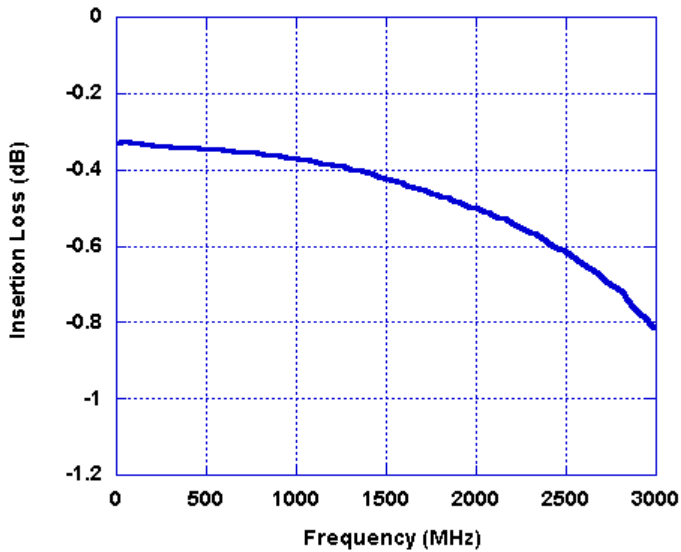

Figure 12. Isolation – Input to Output

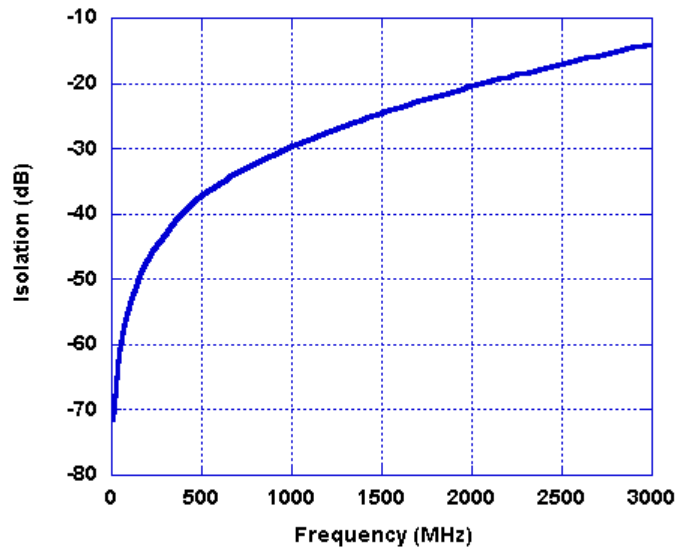

Figure 13. Isolation – Output to Output

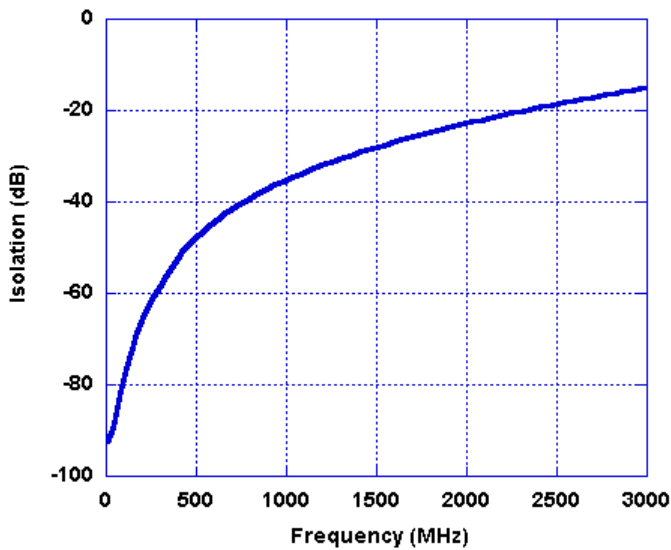

Figure 14. Return Loss (Input & Output)

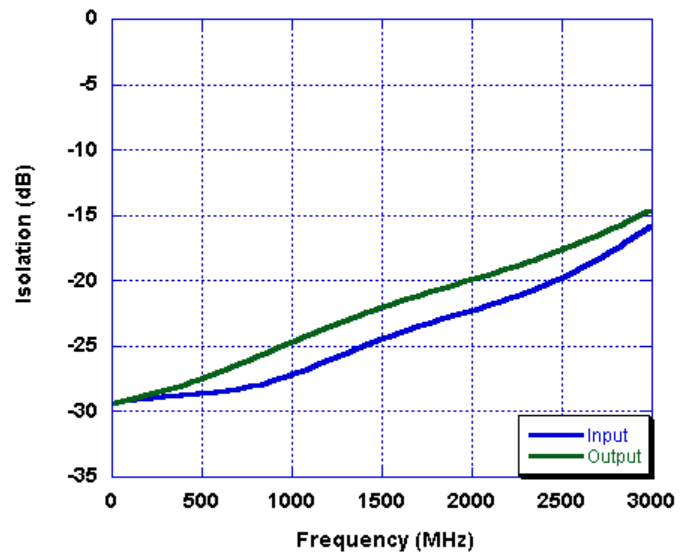

Figure 15. Package Drawing

6-lead SC-70

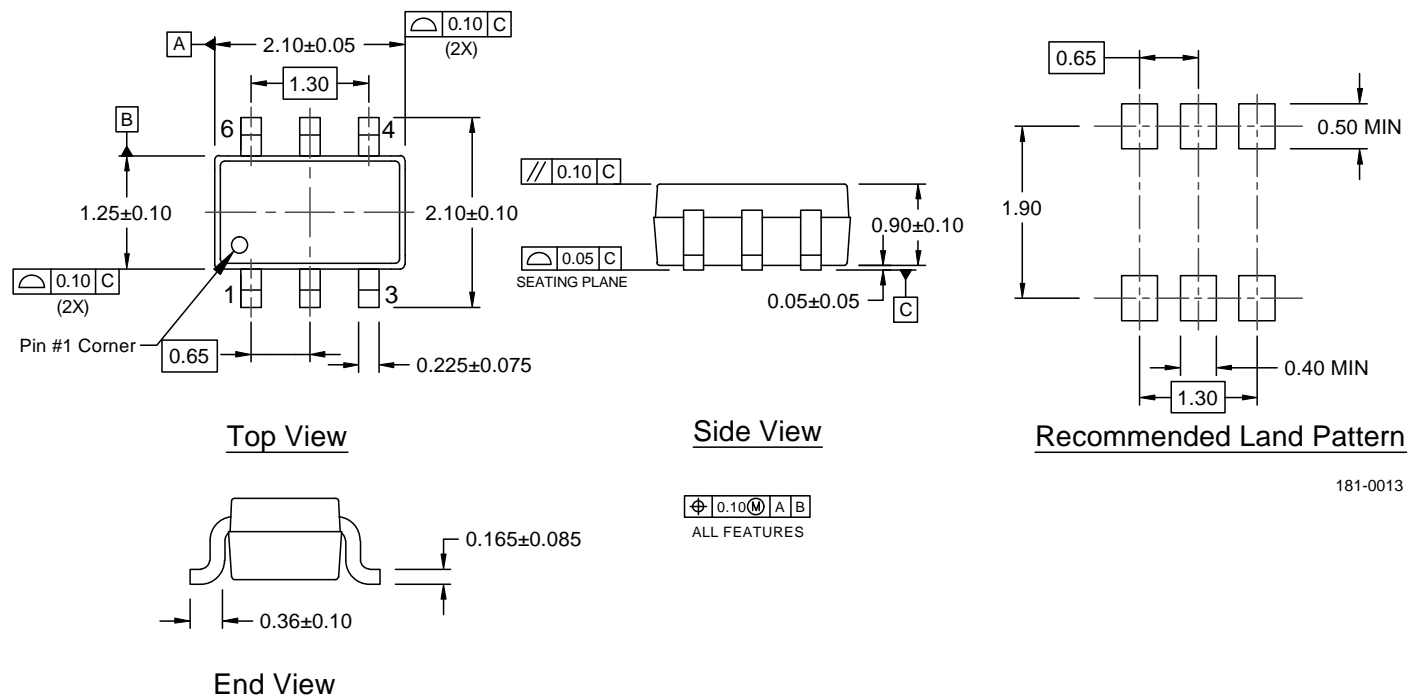
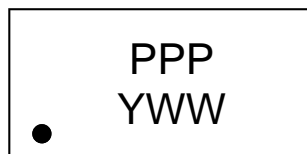

Figure 16. Top Marking Specification



- = Pin 1 Indicator
- PPP = Part Number
- YWW = Date Code

17-0021