

Product Description

The PE42430 is a HaRP™-enhanced reflective SP3T RF switch developed on the UltraCMOS® process technology. This tiny general purpose switch is ideal for WLAN and bluetooth applications in the 2.4 - 2.5 GHz bands as well as general broadband switching applications. It is comprised of three RF ports and has low insertion loss and high isolation. An on-chip CMOS decode logic facilitates a three-pin CMOS control interface. Unlike competitive solutions, there is no need for blocking capacitors when using the PE42430.

Peregrine's HaRP™ technology enhancements deliver high linearity and exceptional harmonics performance. It is an innovative feature of the UltraCMOS® process, providing performance superior to GaAs with the economy and integration of conventional CMOS.

UltraCMOS® SP3T Reflective RF Switch 100 – 3000 MHz

Features

- HaRP™-enhanced UltraCMOS® device
- Low insertion loss
 - Typical 0.45 dB @ 1 GHz
 - Typical 0.55 dB @ 2.5 GHz
- IIP3: Typical +66 dBm
- P0.1dB Compression: Typical +30 dBm
- Excellent ESD tolerance of 4500V HBM and 250V MM on all ports
- No external V_{DD} required. V_{DD} is derived from switch control inputs
- Package type: 8-lead 1.5 x 1.5 mm DFN

Figure 1. Functional Diagram

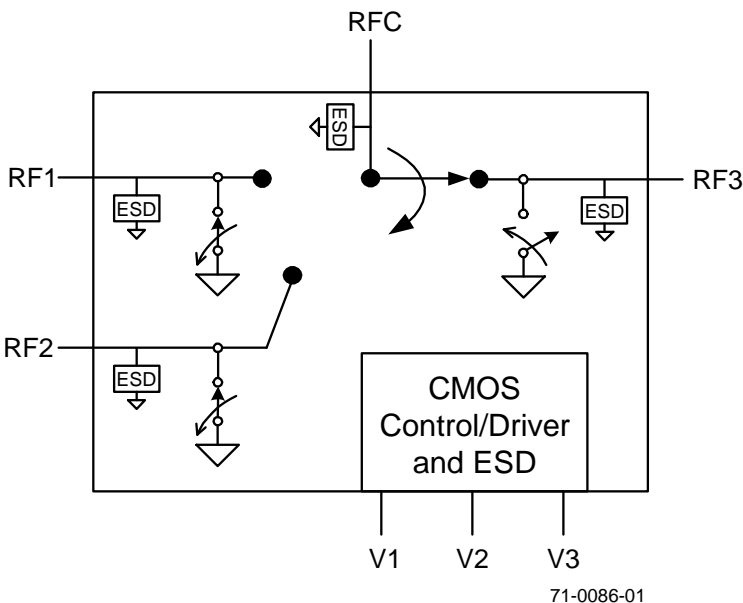

Figure 2. Package Type

8-lead 1.5 x 1.5 mm DFN

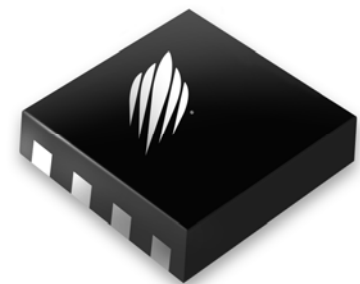

Table 1. Electrical Specifications¹: Nominal @ 25°C, V1, V2 or V3 = 3V/5V ($Z_S = Z_L = 50 \Omega$)

Electrical Parameter	Path	Condition	Min	Typ	Max	Unit
Operating Frequency			100		3000	MHz
Insertion Loss	RFC-RFX	100 to 1000 MHz		0.45	0.56	dB
		1000 to 3000 MHz		0.65	0.9	dB
		2400 to 2500 MHz		0.55	0.8	dB
Isolation	RFX-RFX	100 to 1000 MHz	35	40		dB
		1000 to 3000 MHz	23	28		dB
		2400 to 2500 MHz	25	30		dB
Isolation	RFC-RFX	100 to 1000 MHz	34	40		dB
		1000 to 3000 MHz	23	28		dB
		2400 to 2500 MHz	25	30		dB
Return Loss (Active Port)	RFX	100 to 1000 MHz		22		dB
		1000 to 3000 MHz		16		dB
		2400 to 2500 MHz		18		dB
Return Loss (Common Port)	RFC	100 to 1000 MHz		22		dB
		1000 to 3000 MHz		16		dB
		2400 to 2500 MHz		18		dB
Input 0.1 dB compression ²	RFC-RFX	100 to 3000 MHz		30		dBm
IIP3	RFC-RFX	100 to 3000 MHz		66		dBm
IIP2	RFC-RFX	100 to 3000 MHz		100		dBm
Switching Time ³		50% CTRL to 90% or 10% of final value		500		nS
Turn on Time ⁴		50% CTRL to 90% or 10% of RF		1.5	2.0	μ S
Video Feedthrough ⁵				10		mV

- Notes: 1. Specifications under min and max nominal conditions
2. Please refer to Maximum Input Power (50 Ω) in *Table 4*
3. Switching time is measured while the part is powered on and one of the control pins is switching state
4. Turn on time is defined as the time it takes the part to go from an unpowered state to 90% RF voltage. Max power can only be applied after the part is turned on
5. Video feedthrough is measured by terminating all ports and measuring peak transients while switching logic state

**Table 3. Electrical Specifications: Min/Max Performance @ -40 to +85°C, V1, V2 or V3 = 3.0V to 5.5V
(Z_S = Z_L = 50 Ω)**

Electrical Parameter	Path	Condition	Min	Typ	Max	Unit
Operating Frequency			100		3000	MHz
Insertion Loss	RFC-RFX	100 to 1000 MHz		0.45	0.65	dB
		1000 to 3000 MHz		0.65	0.95	dB
		2400 to 2500 MHz		0.55	0.85	dB
Isolation	RFX-RFX	100 to 1000 MHz	35	40		dB
		1000 to 3000 MHz	23	28		dB
		2400 to 2500 MHz	25	30		dB
Isolation	RFC-RFX	100 to 1000 MHz	34	40		dB
		1000 to 3000 MHz	23	28		dB
		2400 to 2500 MHz	25	30		dB

Figure 3. Pin Configuration (Top View)

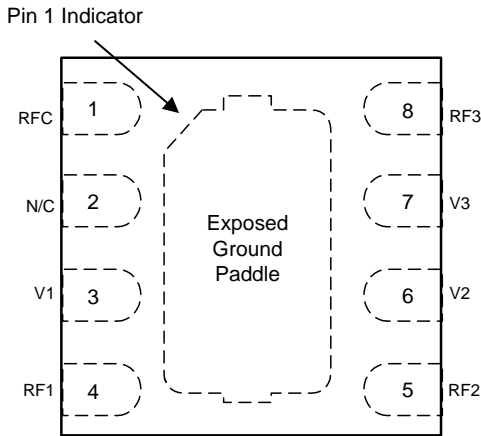

Table 3. Pin Descriptions

Pin #	Pin Name	Description
1	RFC ¹	RF Common
2	N/C	No Connect
3	V1	Switch Control Input, CMOS logic level
4	RF1 ¹	RF I/O
5	RF2 ¹	RF I/O
6	V2	Switch Control Input, CMOS Logic Level
7	V3	Switch Control Input, CMOS Logic Level
8	RF3 ¹	RF I/O
Paddle	GND	Exposed Ground Paddle. Ground for Proper Device Operation

Note 1: RF pins 1, 4, 5 and 8 must be at 0 VDC. The RF pins do not require DC blocking capacitors for proper operation if the 0 VDC requirement is met

Table 4. Operating Ranges

Parameter	Symbol	Min	Typ	Max	Units
I _{DD} Power Supply Current	I _{DD}		130	230	μA
V _{CTRL} Control Voltage High	V _{IH}	3		5.5	V
V _{CTRL} Control Voltage Low	V _{IL}	0		0.6	V
Operating temperature range	T _{OP}	-40		+85	°C
Maximum Input Power (50 Ω) CW @ +85°C CW @ +25°C	P _{in}			+27 +30	 dBm dBm

Table 5. Absolute Maximum Ratings

Symbol	Parameter/Conditions	Min	Max	Units
T _{ST}	Storage temperature range	-55	+150	°C
P _{IN}	Maximum Input Power (50 Ω)		30	dBm
V _{ESD}	ESD Voltage HBM ¹ All Pins		4500	V
V _{ESD}	ESD Voltage MM ² , All Pins		250	V

Notes: 1. HBM ESD Voltage (MIL_STD 883 Method 3015.7)
2. MM ESD Voltage (MM, JEDEC JESD22-A115-A)

Exceeding absolute maximum ratings may cause permanent damage. Operation should be restricted to the limits in the Operating Ranges table.

Electrostatic Discharge (ESD) Precautions

When handling this UltraCMOS[®] device, observe the same precautions that you would use with other ESD-sensitive devices. Although this device contains circuitry to protect it from damage due to ESD, precautions should be taken to avoid exceeding the specified rating.

Moisture Sensitivity Level

The Moisture Sensitivity Level rating for the PE42430 in the 8-lead 1.5 x 1.5 mm DFN package is MSL1.

Latch-Up Avoidance

Unlike conventional CMOS devices, UltraCMOS[®] devices are immune to latch-up.

Table 6. Truth Table

Path	V1	V2	V3
RFC - RF1	1	0	0
RFC - RF2	0	1	0
RFC - RF3	0	0	1

Note: Any state other than shown in *Table 6* are undefined states

Switching Frequency

The PE42430 has a maximum 25 kHz switching rate.

Figure 4. Insertion Loss vs Temperature (RFX-RFC)

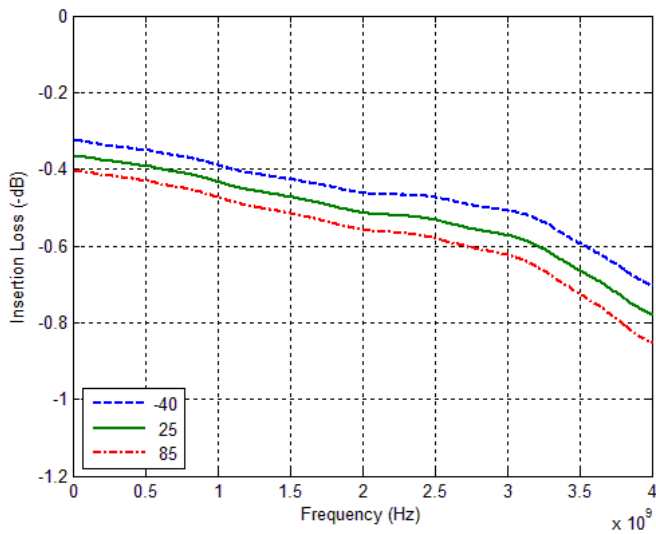

Figure 5. Insertion Loss vs V_{DD} (RFX-RFC)

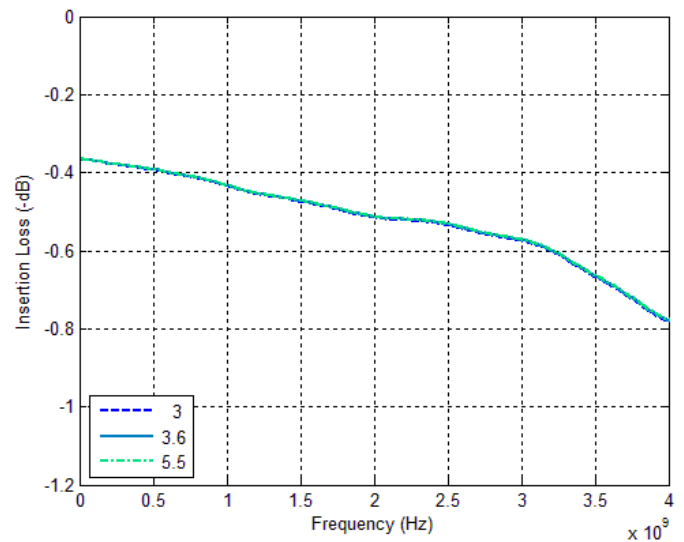

Figure 6. Insertion Loss RFX

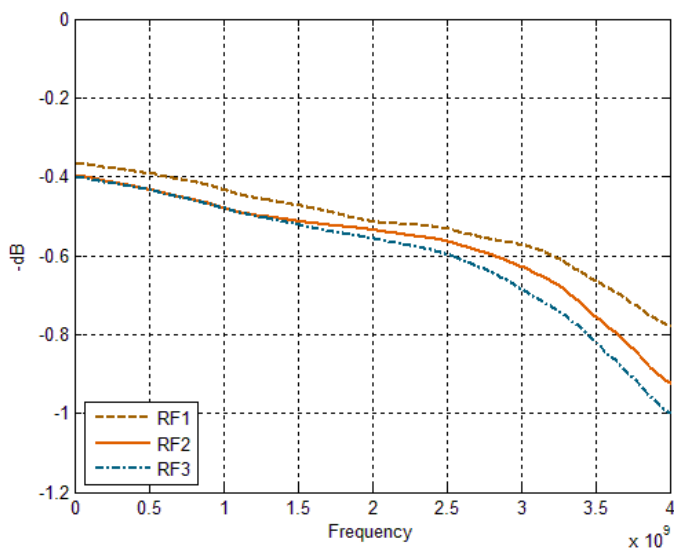

Figure 7. RFX-RFX Isolation vs Temperature

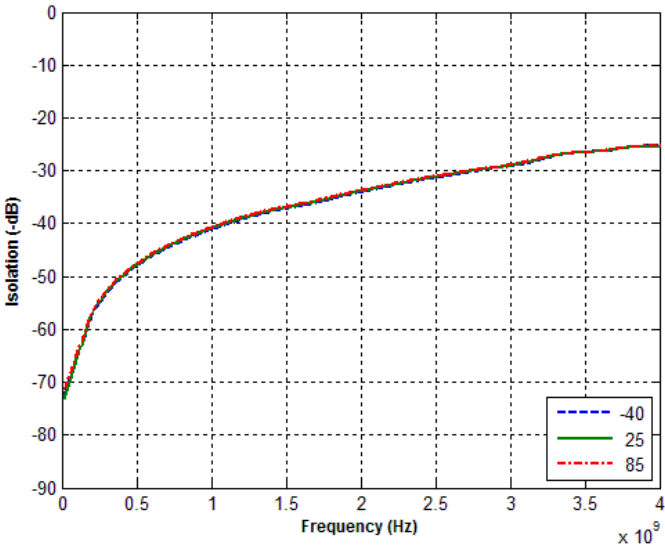

Figure 8. RFX-RFX Isolation vs V_{DD}

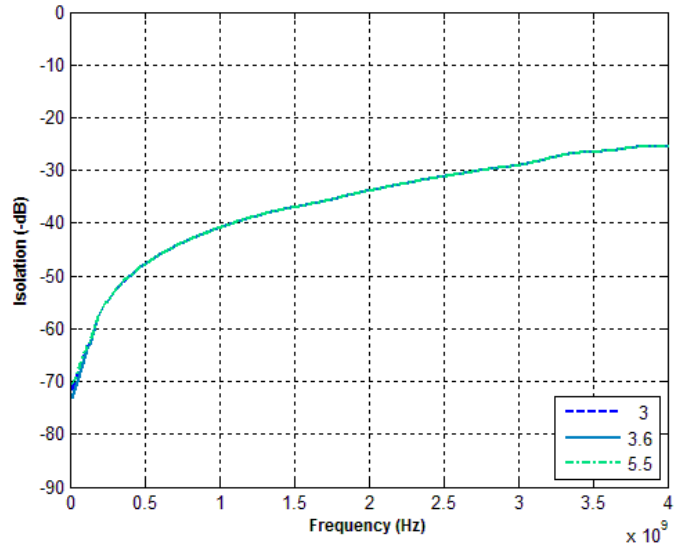

Figure 9. RFC-RFX Isolation vs Temperature

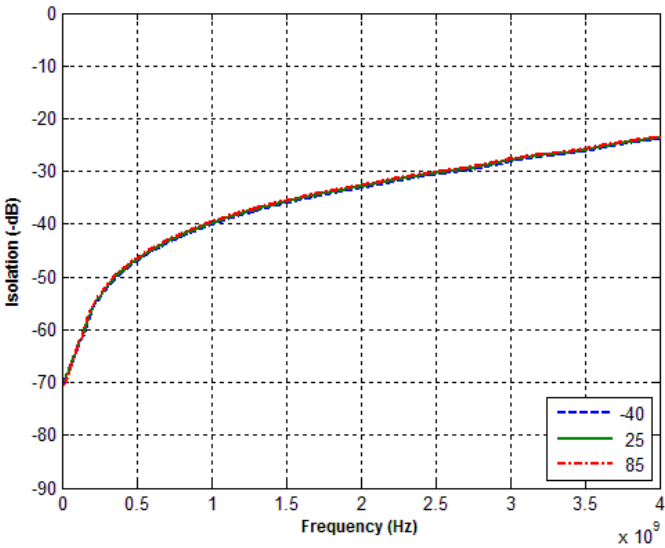

Figure 10. RFC-RFX Isolation vs V_{DD}

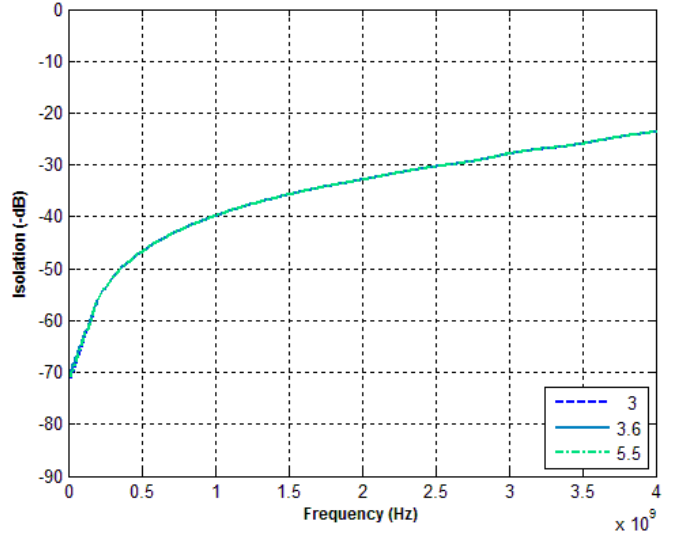

Figure 11. RFC Port Return Loss vs Temperature

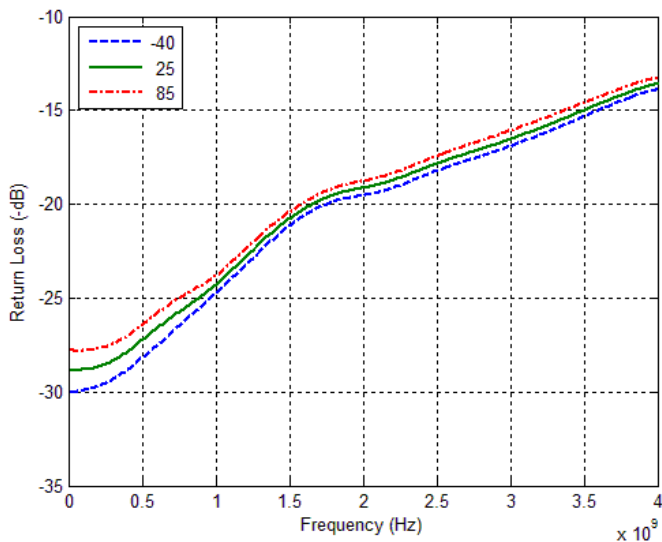

Figure 12. RFC Port Return Loss vs V_{DD}

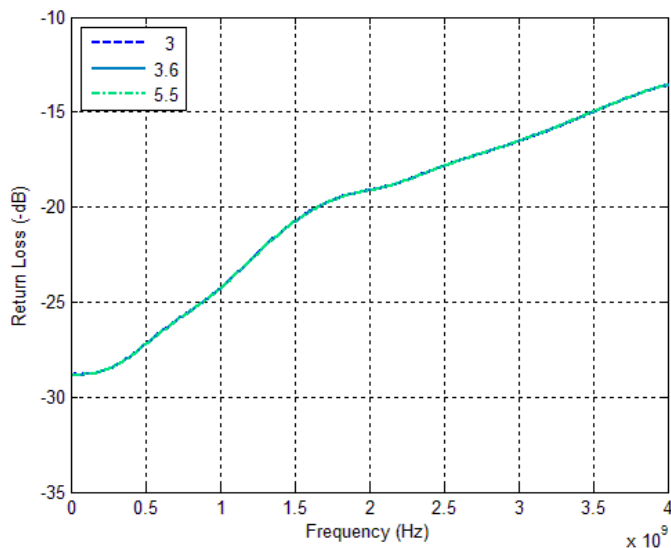

Figure 13. Active Port Return Loss vs Temperature (RFX)

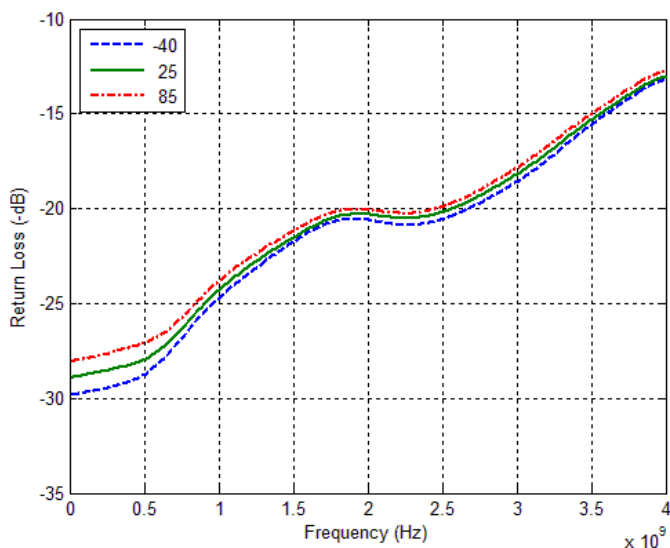
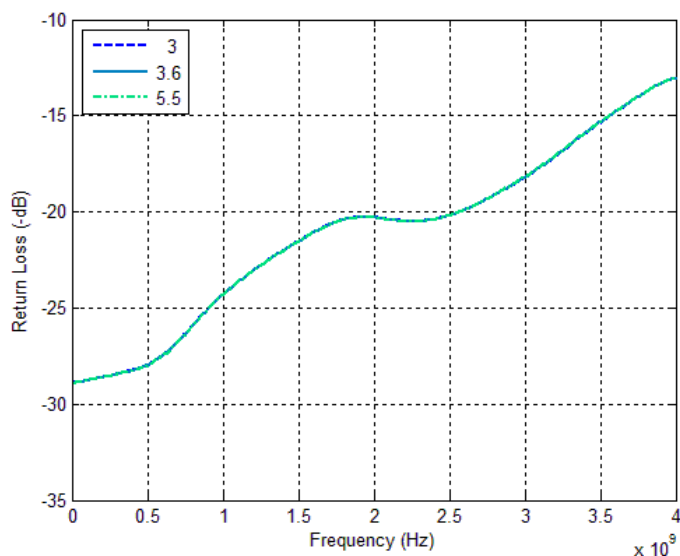

Figure 14. Active Port Return Loss vs V_{DD} (RFX)



Evaluation Kit Information

The SP3T Switch Evaluation Kit facilitates customer evaluation of the PE42430 SP3T switch. The RF common port is connected through a 50 Ω transmission line to J2. Ports 1, 2 and 3 are connected through 50 Ω transmission lines to J3, J5 and J4 respectively. J1 provides digital inputs V1, V2 and V3 to the device.

On the back of the board, a through line connects SMA connectors J6 and J7. This transmission line can be used to estimate the PCB loss over the environmental conditions.

This four layer board is composed of Rogers 4350 on the top and bottom and FR4 on the inner layers with a total thickness of 0.062". All transmission lines have 21.5 mil width and 7.25 mil gap.

Use jumpers on header J1 to short the control pins to ground for logic low. V_{DD} is supplied to the part through at least one of the control pins via Pins 1, 3 or 5 (V3, V2, V1) on header J1.

Figure 15. Evaluation Board Layouts

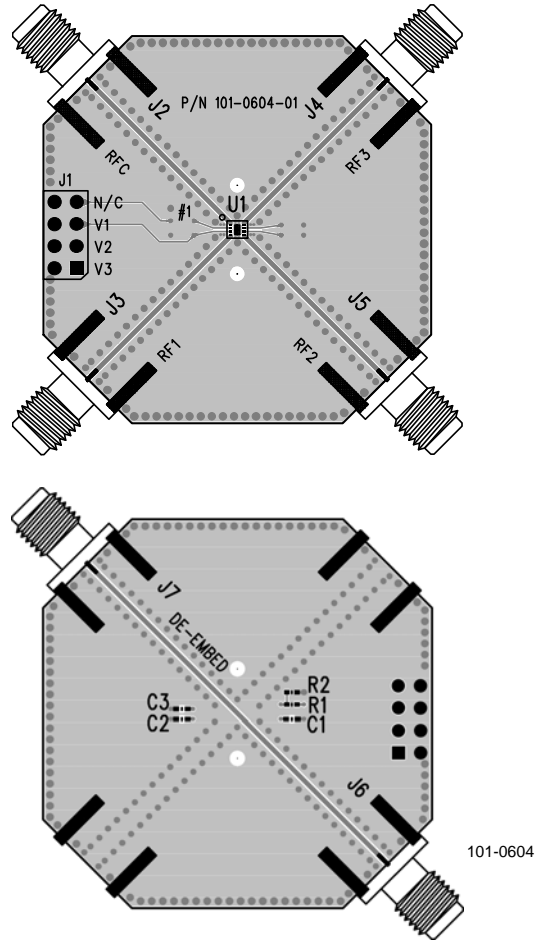

Figure 16. Evaluation Kit Schematics

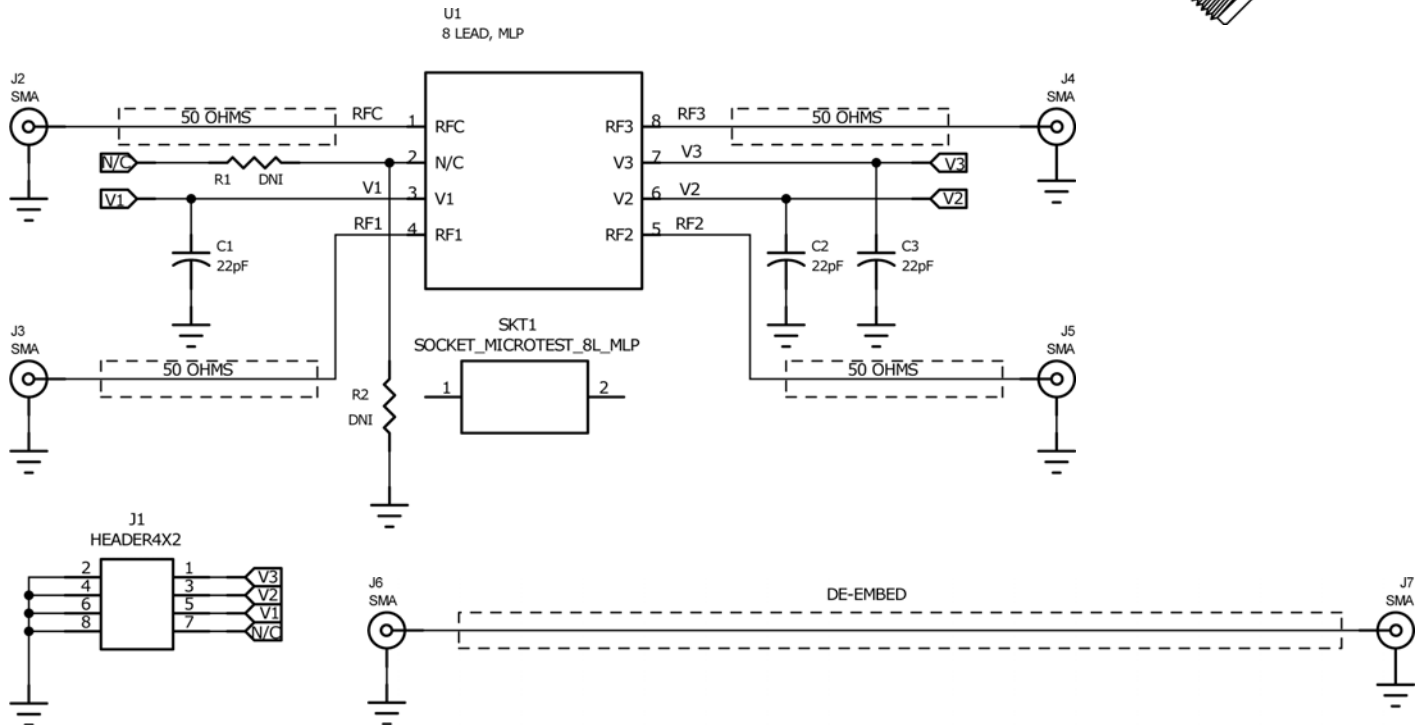

Figure 17. Mechanical Specifications

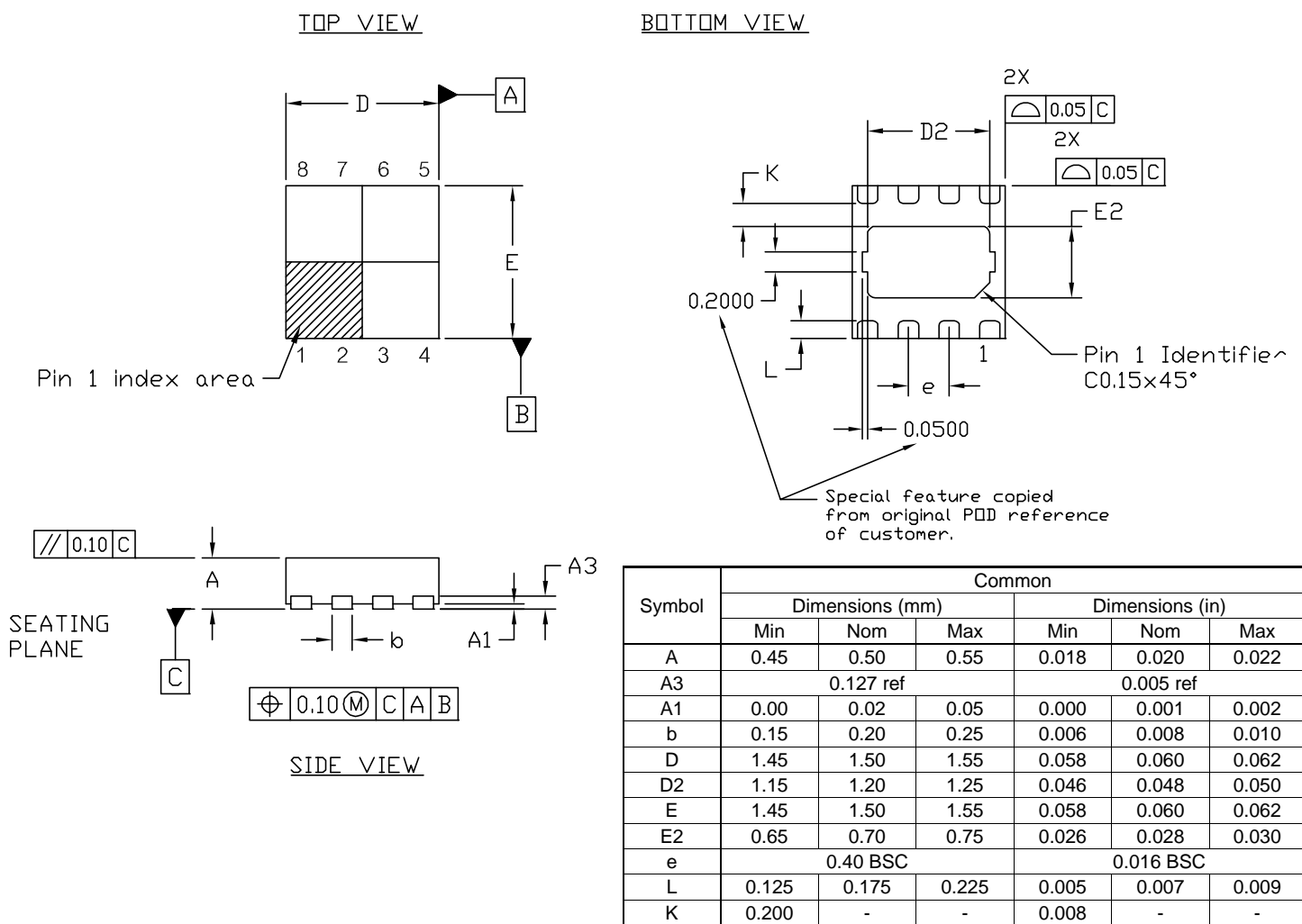
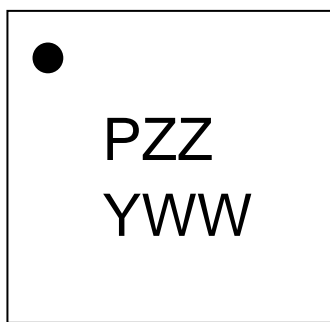

Figure 18. Marking Specifications



17-0154

Marking Spec Symbol	Package Marking	Definition
P	A-Z	Part# code
ZZ	00-99	Last two digits of lot code
Y	0-9	Last digit of year, starting from 2011 (1 for 2011, 2 for 2012 etc)
WW	01-53	Work week