

PE42546

Document Category: Product Specification

UltraCMOS® SP4T RF Switch, 9 kHz–52 GHz



Features

- Wideband support up to 52 GHz
- Low insertion loss of 2.9 dB @ 45 GHz
- Fast switching time of 60 ns
- High input P1dB of 35 dBm
- High port-to-port isolation of 41 dB
- -40 °C to +105 °C operating temperature support
- Package: 20-lead 3×3 mm LGA

Applications

- Test and measurement (T&M)
- 5G mmWave
- Microwave backhaul
- Radar
- Satellite communications

Figure 1 ■ PE42546 Functional Diagram

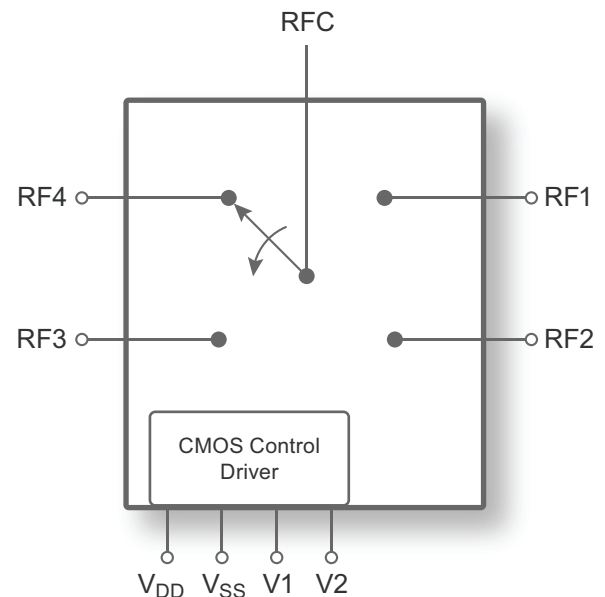

Product Description

The PE42546 is a HaRP™ technology-enhanced reflective SP4T RF switch die that supports a wide frequency range from 9 kHz to 52 GHz. It delivers low insertion loss, fast switching time and high isolation performance, making this device ideal for test and measurement (T&M), 5G mmWave, microwave backhaul, radar and satellite communication applications. No blocking capacitors are required if DC voltage is not present on the RF ports.

The PE42546 is manufactured on pSemi's UltraCMOS® process, a patented variation of silicon-on-insulator (SOI) technology.

Absolute Maximum Ratings

Exceeding absolute maximum ratings listed in **Table 1** may cause permanent damage. Operation should be restricted to the limits in **Table 2**. Operation between operating range and absolute maximum for extended periods may reduce reliability.

ESD Precautions

When handling this UltraCMOS device, observe the same precautions as with any other ESD-sensitive devices. Although this device contains circuitry to protect it from damage due to ESD, precautions should be taken to avoid exceeding the rating specified in **Table 1**.

Latch-up Immunity

Unlike conventional CMOS devices, UltraCMOS devices are immune to latch-up.

Table 1 ■ Absolute Maximum Ratings for PE42546

| Parameter/Condition | Min | Max | Unit |
|---|------|----------------------|------|
| V _{DD} Positive Supply Voltage | -0.3 | 3.6 | V |
| V _{SS} Negative Supply Voltage | -3.6 | 0.3 | V |
| Digital Input Voltage | -0.3 | V _{DD} +0.3 | V |
| Storage Temperature | -65 | 150 | °C |
| ESD voltage HBM, All Pins Except RF ⁽¹⁾ | 2000 | | V |
| ESD voltage HBM, RF Pins ⁽¹⁾ | 600 | | V |
| ESD voltages, CDM, All Pins ⁽²⁾ | 1000 | | V |
| Notes: 1) Human body model (MIL-STD 883 Method 3015). 2) Charged device model (JEDEC JESD22-C101). | | | |

Recommended Operating Conditions

Table 2 lists the recommended operating conditions for the PE42546. Devices should not be operated outside the operating conditions listed below.

Table 2 ▪ *Recommended Operating Conditions for PE42546*

| Parameter | Min | Typ | Max | Unit |
|----------------------------------|-------|------|---------------|------|
| VDD Positive Supply Voltage | 3.15 | 3.3 | 3.45 | V |
| VSS Negative Supply Voltage | -3.45 | -3.3 | -3.15 | V |
| IDD Positive Supply Current | | 3 | | μA |
| ISS Negative Supply Current | | -110 | | μA |
| Control Voltage High | 1.2 | | 3.3 | V |
| Control Voltage Low | 0 | | 0.8 | V |
| Digital Input Leakage Current | | | 35 | μA |
| RF Input Power, CW (RFC-RFX) | | | Fig. 2 | dBm |
| RF Input Power, Pulsed (RFC-RFX) | | | Fig. 2 | dBm |
| Temperature Range | -40 | 25 | 105 | °C |

Electrical Specifications

Table 3 provides the PE42546 key electrical specifications @ +25 °C, $V_{DD} = 3.3V$, $V_{SS} = -3.3V$ unless otherwise specified.

Table 3 ▪ Electrical Specifications for PE42546

| Parameter | Description | Frequency (MHz) | Min | Typ | Max | Unit |
|----------------------------------|-------------|-----------------|-----|-----|-----|------|
| Insertion Loss | | 10 | | 1.1 | 1.3 | dB |
| | | 10 to 18000 | | 2.0 | 2.5 | dB |
| | | 18000 to 35000 | | 2.3 | 3.0 | dB |
| | | 35000 to 40000 | | 2.5 | 3.4 | dB |
| | | 40000 to 45000 | | 2.9 | 4.2 | dB |
| | | 45000 to 52000 | | 3.7 | 4.8 | dB |
| Isolation | RFC to RFX | 10 to 18000 | 39 | 41 | | dB |
| | | 18000 to 35000 | 31 | 35 | | dB |
| | | 35000 to 40000 | 31 | 35 | | dB |
| | | 40000 to 45000 | 27 | 32 | | dB |
| | | 45000 to 52000 | 23 | 23 | | dB |
| | RFX to RFX | 10 to 18000 | 35 | 37 | | dB |
| | | 18000 to 35000 | 31 | 33 | | dB |
| | | 35000 to 40000 | 29 | 32 | | dB |
| | | 40000 to 45000 | 26 | 30 | | dB |
| | | 45000 to 52000 | 24 | 27 | | dB |
| Return Loss (Common Port) | | 10 to 8000 | | 13 | | dB |
| | | 8000 to 30000 | | 13 | | dB |
| | | 30000 to 35000 | | 12 | | dB |
| | | 35000 to 45000 | | 12 | | dB |
| | | 45000 to 52000 | | 12 | | dB |
| Return Loss (Active Port) | | 10 to 35000 | | 12 | | dB |
| | | 35000 to 45000 | | 12 | | dB |
| | | 45000 to 52000 | | 11 | | dB |
| 0.1dB Compression ^(*) | | 14 GHz | | 27 | | dBm |
| 1 dB Compression ^(*) | | 14 GHz | | 35 | | dBm |

Table 3 ■ Electrical Specifications for PE42546

| Parameter | Description | Frequency (MHz) | Min | Typ | Max | Unit |
|--|-------------------------------------|-----------------|-----|-----|-----|------|
| Input IP2 | | 100 | | 103 | | dBm |
| | | 746 | | 105 | | dBm |
| | | 1974 | | 110 | | dBm |
| | | 2635 | | 111 | | dBm |
| Input IP3 | | 746 | | 52 | | dBm |
| | | 1974 | | 53 | | dBm |
| | | 2635 | | 53 | | dBm |
| | | 24900 | | 52 | | dBm |
| | | 40200 | | 52 | | dBm |
| | | 47900 | | 52 | | dBm |
| Switching Time | 50% VCTL to 10% to 90% of RF output | | | 60 | | nsec |
| Note: * Pulse 100 μ s duty cycle 10%. | | | | | | |

Power De-rating Curve

Figure 2 shows the power de-rating curve for the PE42546 from 10 kHz–52 GHz @ –40°C to +105 °C ambient, (50Ω).

Figure 2 ▪ Power De-rating Curve for PE42546

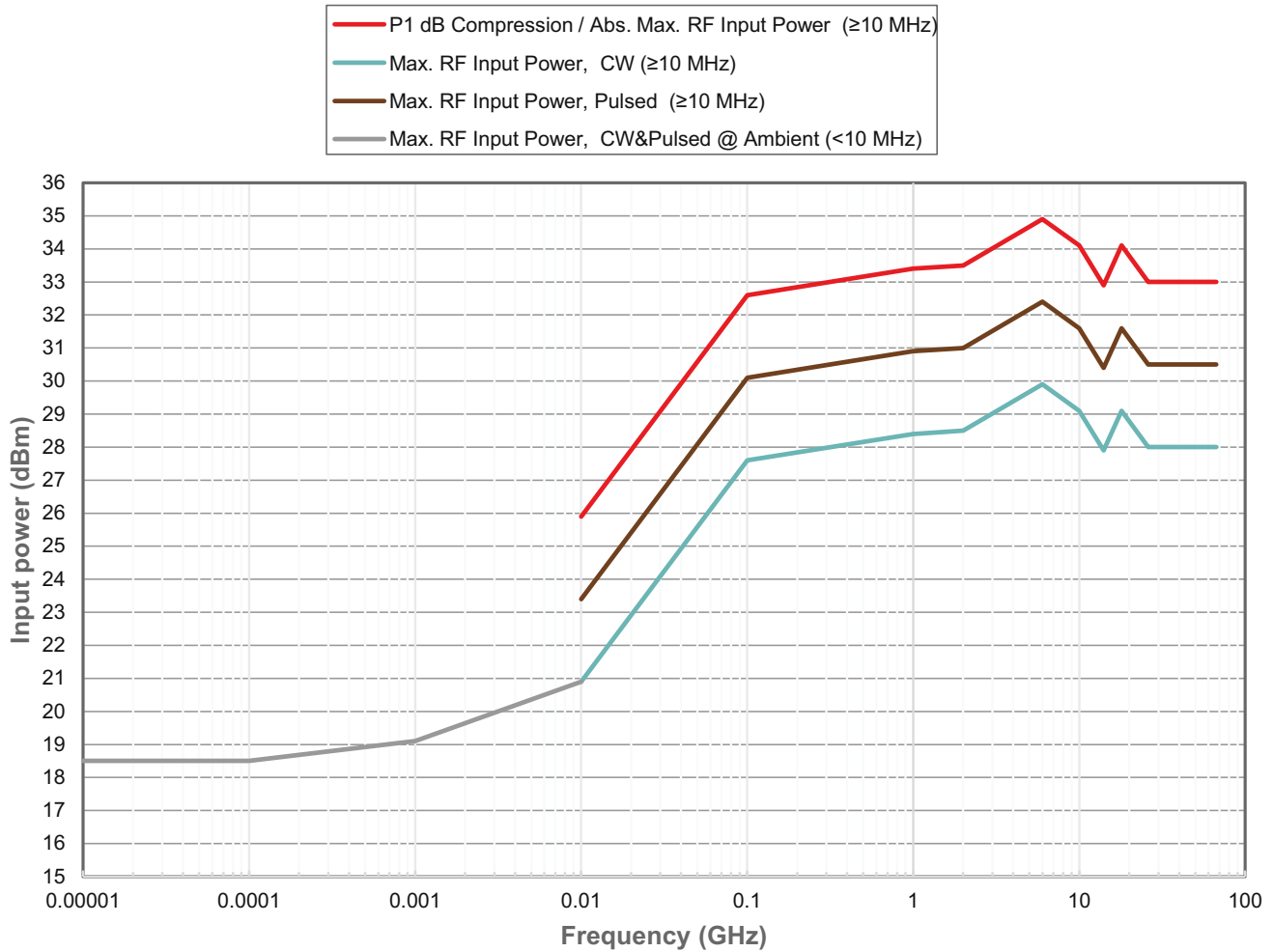

Typical Performance Data

Figure 3–Figure 13 show the typical performance data at +25 °C, $V_{DD} = 3.3V$, $V_{SS} = -3.3V$ ($Z_S = Z_L = 50\Omega$), unless otherwise specified.

Figure 3 ■ Insertion Loss RFC to RFX vs. Frequency

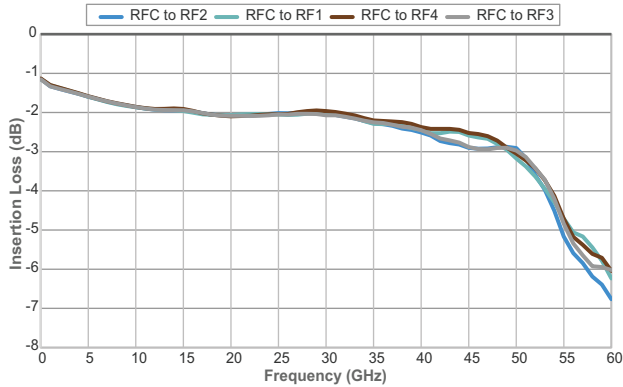

Figure 4 ■ Insertion Loss vs. Temperature (RFC–RF1)

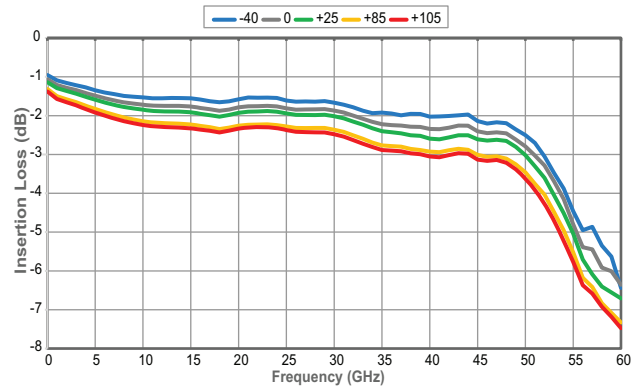

Figure 5 ■ Insertion Loss vs. Temperature (RFC–RF2)

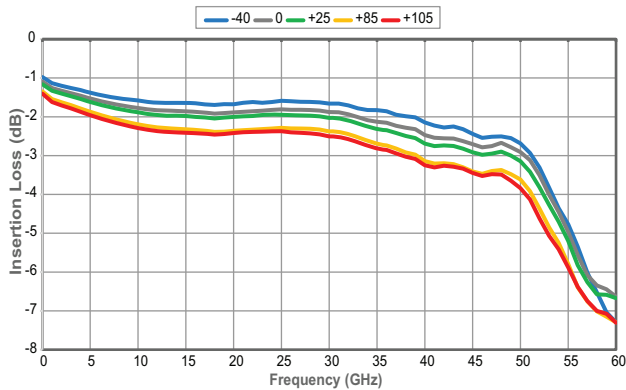

Figure 6 ■ Isolation (RFC–RFX)

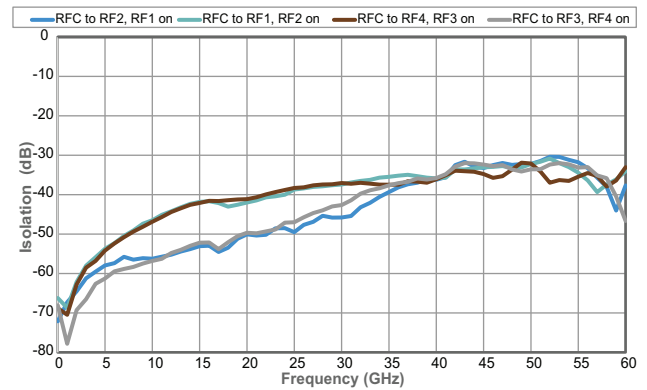

Figure 7 ■ Isolation (RFX–RFX)

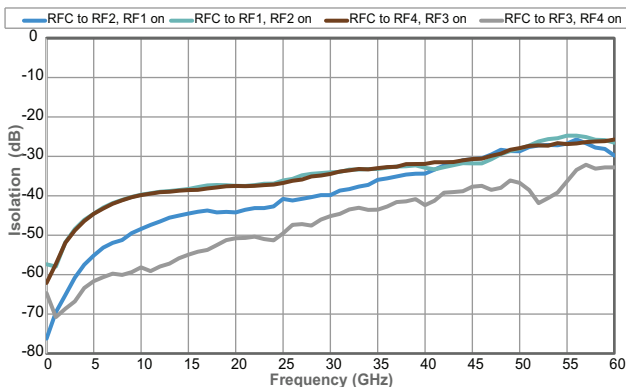

Figure 8 ■ Isolation vs. Temperature (RF1–RF2, RF1 On)

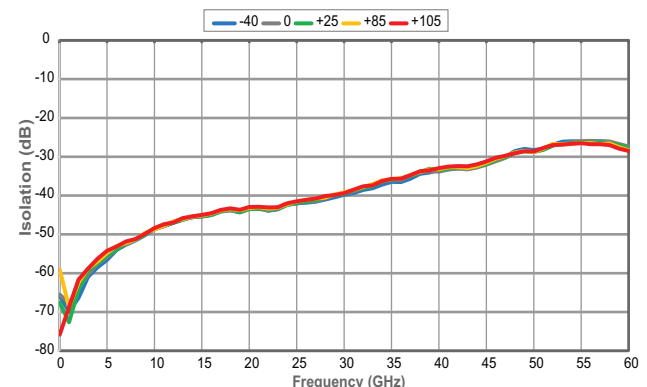

Figure 9 ■ Isolation vs. Temperature (RF1–RF2, RF2 On)

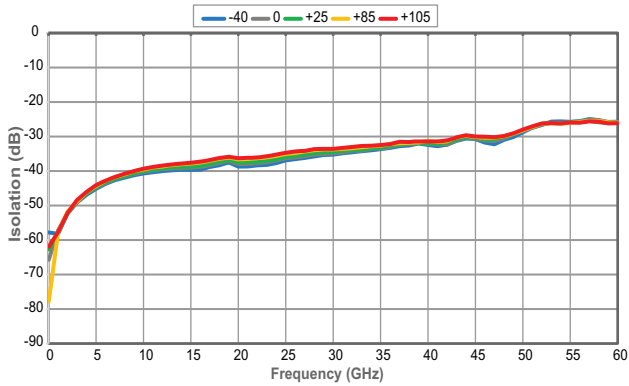

Figure 10 ■ Isolation vs. Temperature (RFC–RF1, RF2 On)

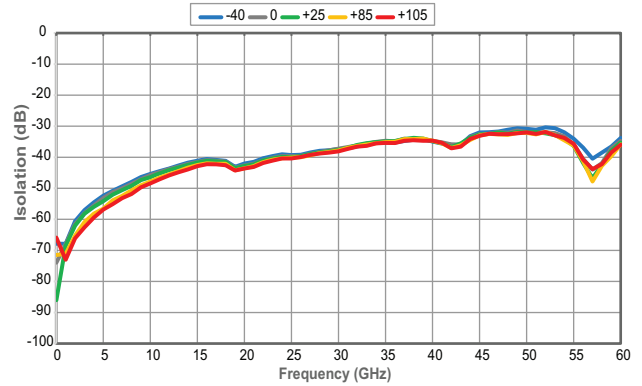

Figure 11 ■ Isolation vs. Temperature (RFC–RF2, RF1 On)

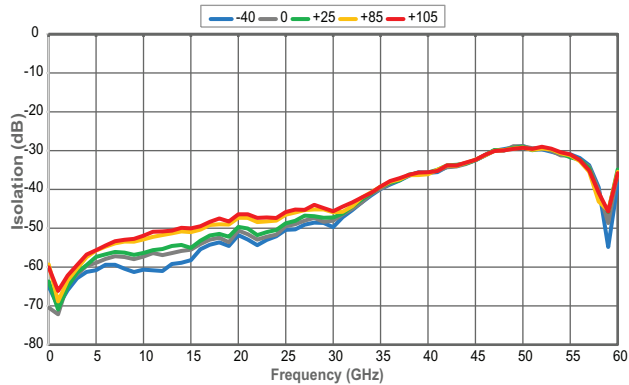

Figure 12 ■ Return Loss Active Port (RFX On)

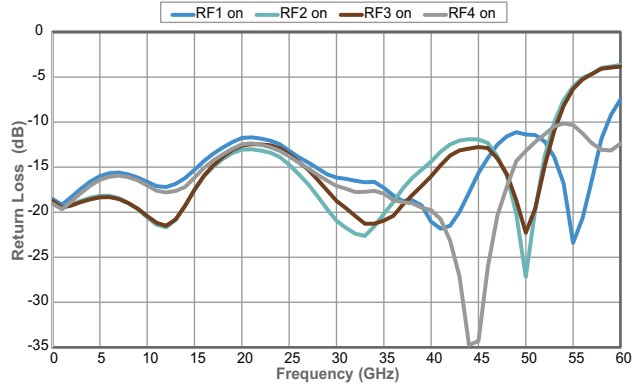
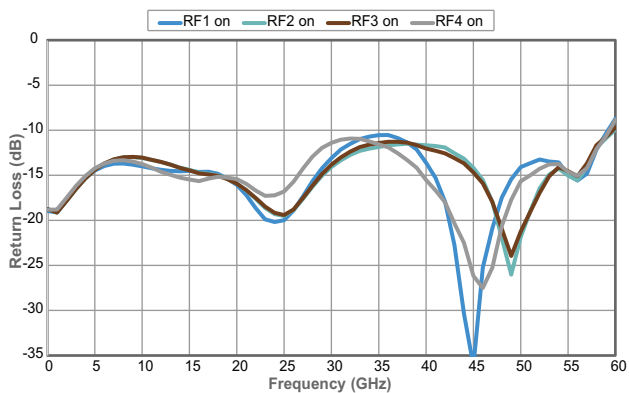

Figure 13 ■ Return Loss Common Port (RFX On)



Evaluation Kit

The SP4T switch evaluation kit board was designed to ease customer evaluation of pSemi's PE42546. The RF common port is connected through a 50Ω transmission line via the top SMA connector, J6. RF1, RF2, RF3 and RF4 are connected through 50Ω transmission lines via SMA connectors J1, J3, J5 and J4, respectively. A through 50Ω transmission is available via SMA connectors J7 and J8. This transmission line can be used to estimate the loss of the PCB over the environmental conditions being evaluated.

The board is constructed of a four-metal-layer material with a total thickness of 62 mils. The dual-clad top RF layer is Astra MT77 material with a 2.5 mil prepreg and $\epsilon_r = 3.00$. The middle layers provide ground for the transmission lines. The transmission lines were designed using a coplanar waveguide with ground plane model using a trace width of 4.75 mils, trace gaps of 4 mils, and metal with 2 mil thickness.

Figure 14 ■ Evaluation Board Layout, Assembly Primary and Secondary Sides for PE42546

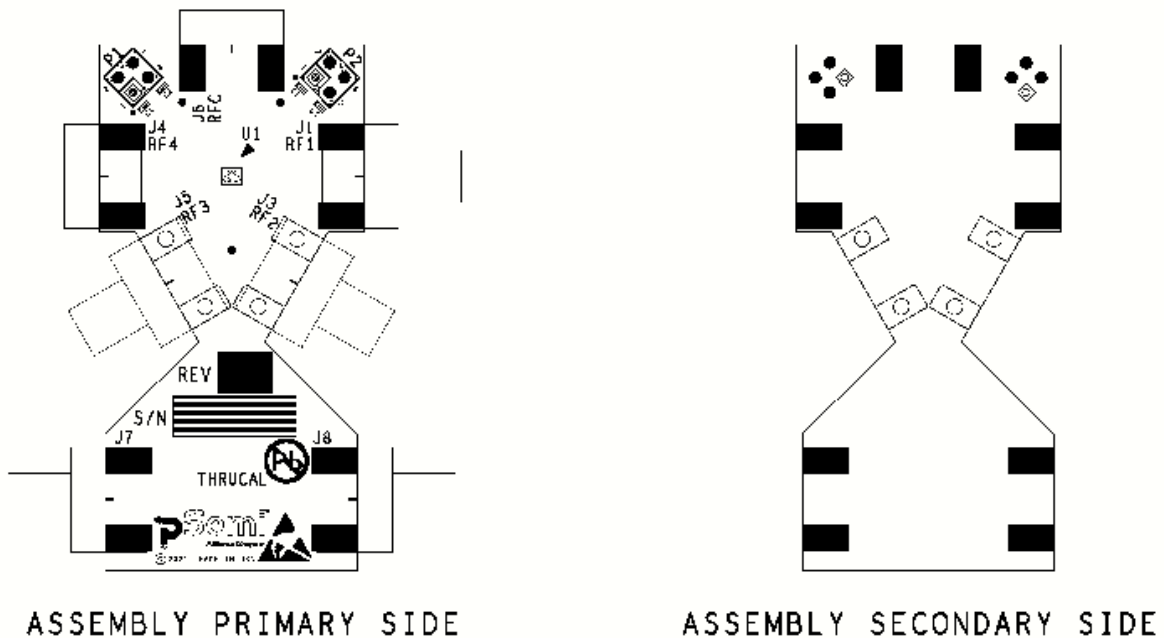
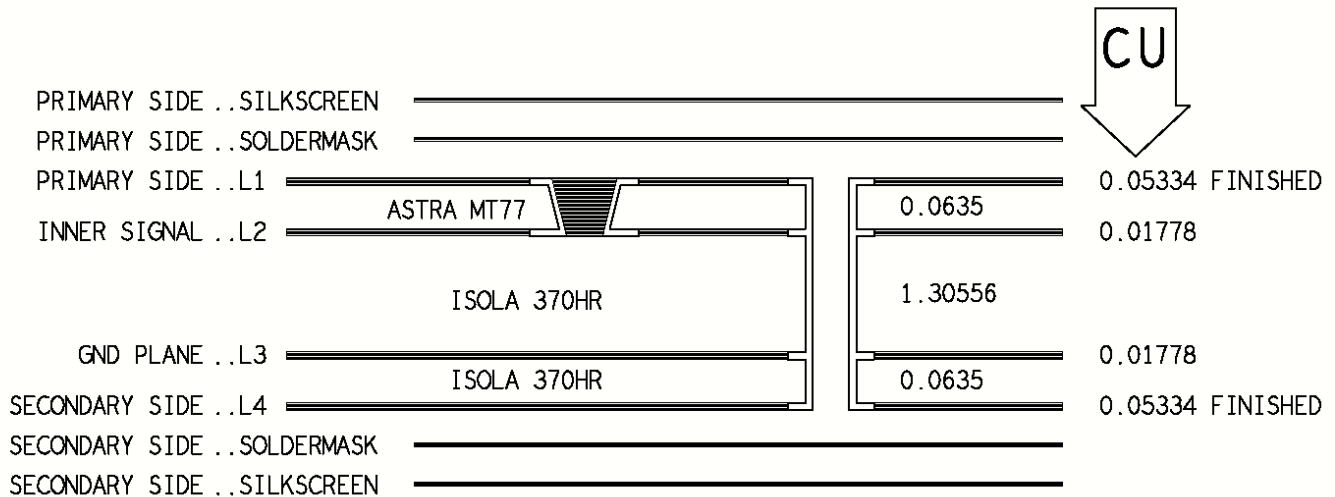

Figure 15 ■ Evaluation Board Layout, Top Layer for PE42546



Figure 16 ■ Evaluation Board Layout, Stack Up for PE42546

4 LAYER - STACK UP



TOTAL BOARD THICKNESS: 1.5748 ± 0.127
UNITS: Metric

Evaluation Board Schematic and BOM

Figure 17 shows the evaluation board schematic. Table 4 shows the evaluation board bill of materials.

Figure 17 ▪ PE42546 Evaluation Board Schematic

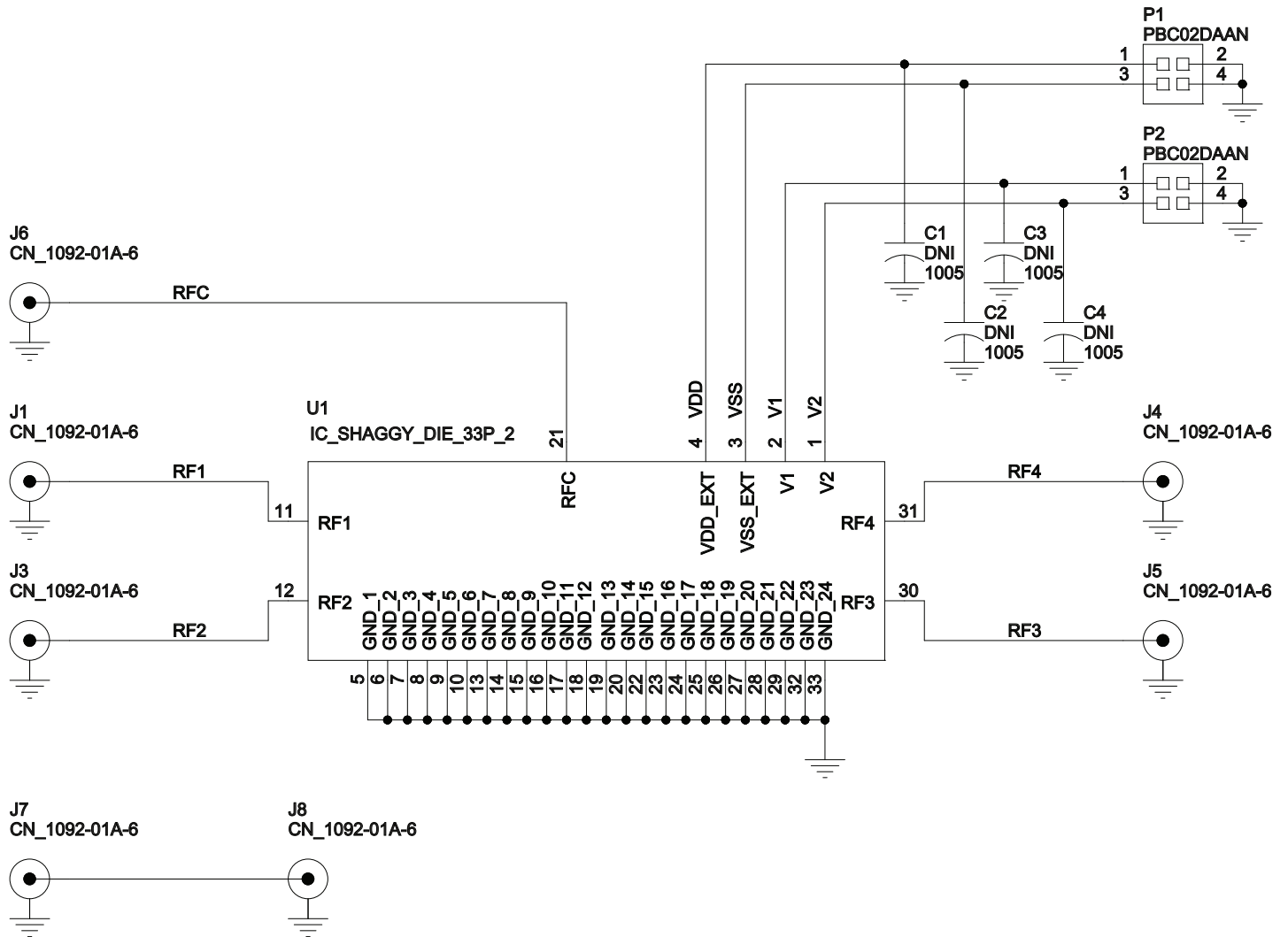

Table 4 ■ PE42546 Evaluation Board BOM Components

| Reference | Value | Description | Manufacturer | Mfg. Part Number |
|-------------|----------------------|--|---------------------|------------------|
| C1,C2,C3,C4 | DNI | CAP, SMD, CER, DNI, n/a, n/a, n/a, 0402 (1005 Metric) | | |
| J1 | CN_1092-01A-6 | CONN, Coaxial Connectors (RF), SMA, SMD, Jack, Female Socket, 67GHz | Southwest Microwave | 1092-01A-6 |
| J3 | CN_1092-01A-6 | CONN, Coaxial Connectors (RF), SMA, SMD, Jack, Female Socket, 67GHz | Southwest Microwave | 1092-01A-6 |
| J4 | CN_1092-01A-6 | CONN, Coaxial Connectors (RF), SMA, SMD, Jack, Female Socket, 67GHz | Southwest Microwave | 1092-01A-6 |
| J5 | CN_1092-01A-6 | CONN, Coaxial Connectors (RF), SMA, SMD, Jack, Female Socket, 67GHz | Southwest Microwave | 1092-01A-6 |
| J6 | CN_1092-01A-6 | CONN, Coaxial Connectors (RF), SMA, SMD, Jack, Female Socket, 67GHz | Southwest Microwave | 1092-01A-6 |
| J7 | CN_1092-01A-6 | CONN, Coaxial Connectors (RF), SMA, SMD, Jack, Female Socket, 67GHz | Southwest Microwave | 1092-01A-6 |
| J8 | CN_1092-01A-6 | CONN, Coaxial Connectors (RF), SMA, SMD, Jack, Female Socket, 67GHz | Southwest Microwave | 1092-01A-6 |
| P1,P2 | PBC02DAAN | CONN, Rectangular Connectors - Headers, Male Pins, Header Unshrouded Breakaway, TH, Male, 2.54mmX2.54mm, 4 POS | | |
| U1 | IC_SHAG-GY_DIE_33P_2 | | | |

Pin Information

This section provides pinout information for the PE42546. **Figure 18** shows the pin map of this device for the available package. **Table 5** provides a description for each pin.

Figure 18 ▪ Pin Configuration (Top View)

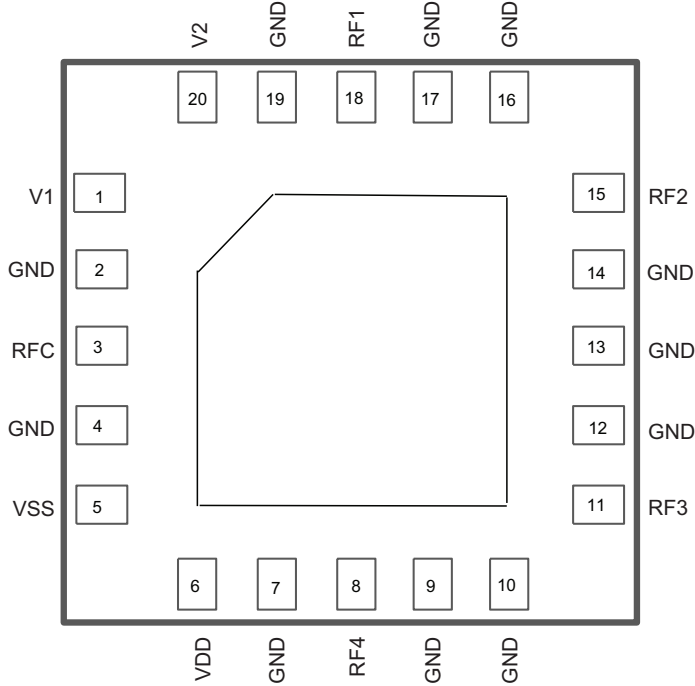

Table 5 ▪ Pin Descriptions for PE42546

| Pin No. | Pin Name | Description |
|---------|----------|-------------------------|
| 1 | V1 | Control input 1 |
| 2 | GND | Ground |
| 3 | RFC | RF common port |
| 4 | GND | Ground |
| 5 | VSS | Negative supply voltage |
| 6 | VDD | Positive supply voltage |
| 7 | GND | Ground |
| 8 | RF4 | RF throw port 4 |
| 9 | GND | Ground |
| 10 | GND | Ground |
| 11 | RF3 | RF throw port 3 |
| 12 | GND | Ground |
| 13 | GND | Ground |
| 14 | GND | Ground |
| 15 | RF2 | RF throw port 2 |
| 16 | GND | Ground |
| 17 | GND | Ground |
| 18 | RF1 | RF throw port 1 |
| 19 | GND | Ground |
| 20 | V2 | Control input 2 |

Control Logic

Table 6 provides the control logic truth table for the PE42546, where 0 = Low (0–0.8V) and 1 = High (1.2–3.3V).

Table 6 ▪ *Truth Table for PE42546*

| V1 | V2 | RF1 | RF2 | RF3 | RF4 |
|----|----|-----------|-----------|-----------|-----------|
| 0 | 0 | ON | Isolation | Isolation | Isolation |
| 1 | 0 | Isolation | ON | Isolation | Isolation |
| 0 | 1 | Isolation | Isolation | ON | Isolation |
| 1 | 1 | Isolation | Isolation | Isolation | ON |

Top-Marking Specification

Figure 20 ▪ Package Marking Specifications for PE42546

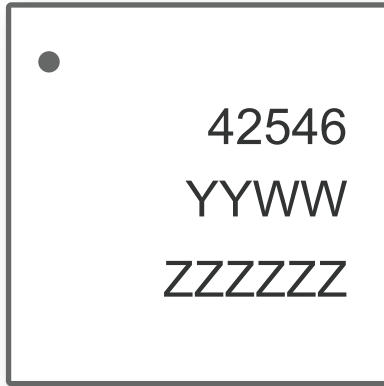

- = Pin 1 indicator
- 42546 = Product part number
- YY = Last two digits of assembly year (2022 = 22)
- WW = Work week of assembly lot start date (01, ..., 52)
- ZZZZZZ = Assembly lot code (max six characters)

DOC-101587-1

Tape and Reel Specification

This section provides the tape and reel specifications for the PE42546.

Figure 21 ▪ Tape and Reel Specifications for PE42546

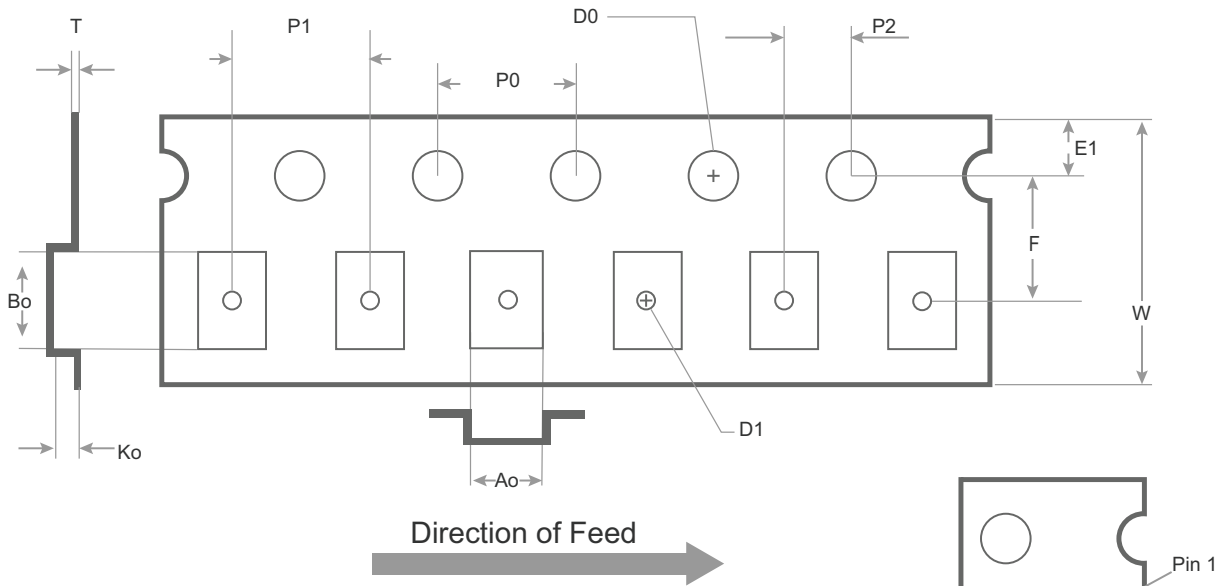

Notes:
Not drawn to scale.
Dimensions are in millimeters.
Maximum cavity angle 5 degrees.
Bumped die are oriented active side down.

| Carrier Tape Dimension Table | | | | | |
|------------------------------|---------|---------------|--------|---------|-------------|
| Pocket | Nominal | Tolerance | Pocket | Nominal | Tolerance |
| Ao | 2.35 | +/- 0.05 | D1 | 0.5 | +/- 0.05 |
| Bo | 2.66 | +/- 0.05 | D0 | 1.5 | + 0.1 / - 0 |
| Ko | 0.39 | +/- 0.05 | E1 | 1.75 | +/- 0.1 |
| P1 | 4.00 | +/- 0.1 | P0 | 4.0 | +/- 0.1 |
| W | 8.00 | + 0.3 / - 0.1 | P2 | 2.0 | +/- 0.05 |
| F | 3.5 | +/- 0.05 | T | 0.2 | +/- 0.05 |

