

## EM-32G210F128-H development board Users Manual



All boards produced by Olimex are ROHS compliant

Revision Initial, September 2011  
Copyright(c) 2011, OLIMEX Ltd, All rights reserved

## **INTRODUCTION:**

EM-32G210F128-H is small header board with EFM32G210F128 Cortex M3 microcontroller from Energy Micro AS. With a unique combination of the powerful 32-bit ARM Cortex-M3, innovative low energy techniques, short wake-up time from energy saving modes, and a wide selection of peripherals, the EFM32G210F128 microcontroller is well suited for any battery operated application as well as other systems requiring high performance and low-energy consumption. On the board are available DBG connector for programming/debugging, UEXT connector for connecting some of our module boards to it, user button, status led and reset button.

## **BOARD FEATURES:**

- MCU: EFM32G210F128
- Debug Interface
- UEXT
- Two extension connectors
- Status Led
- User button
- Reset button
- Battery connector
- FR-4, 1.5 mm, soldermask, component print
- Dimensions: 43.00 x 34.50mm (1.69 x 1.36")

## **ELECTROSTATIC WARNING:**

The **EM-32G210F128-H** board is shipped in protective anti-static packaging. The board must not be subject to high electrostatic potentials. General practice for working with static sensitive devices should be applied when working with this board.

## **BOARD USE REQUIREMENTS:**

**Cables:** The cable you will need depends on the programmer/ debugger you use. If you use [ARM-JTAG-EW](#), you will need USB A-B cable.

**Hardware:** Programmer/Debugger [ARM-JTAG-EW](#) or other compatible programming/ debugging tool if you work with EW-ARM.

## **PROCESSOR FEATURES:**

**EM-32G210F128-H** board use ARM 32-bit Cortex-M3 microcontroller **EFM32G210F128** from Energy Micro AS with these features:

- ARM Cortex-M3 CPU platform
  - High Performance 32-bit processor @ up to 32 MHz
  - Memory Protection Unit
  - Wake-up Interrupt Controller
- Flexible Energy Management System
  - 20 nA @ 3 V Shutoff Mode
  - 0.6  $\mu$ A @ 3 V Stop Mode, including Power-on Reset, Brown-out Detector, RAM and CPU retention
  - 0.9  $\mu$ A @ 3 V Deep Sleep Mode, including Real Time Clock with 32.768 kHz oscillator, Power-on Reset, Brown-out Detector, RAM and CPU retention
  - 45  $\mu$ A/MHz @ 3 V Sleep Mode
  - 180  $\mu$ A/MHz @ 3 V Run Mode, with code executed from flash
- 128 KB Flash
- 16 KB RAM
- 24 General Purpose I/O pins
  - Configurable Push-pull, Open-drain, pull-up/ down, input filter, drive strength
  - Configurable peripheral I/O locations
  - 14 asynchronous external interrupts
- 8 Channel DMA Controller

- 8 Channel Peripheral Reflex System for autonomous inter-peripheral signaling
- Hardware AES with 128/256-bit keys in 54/75 cycles
- Timers/Counters
  - 2× 16-bit Timer/Counter
    - 2×3 Compare/Capture/PWM channels
    - Dead-Time Insertion on TIMER0
  - 16-bit Low Energy Timer
  - 24-bit Real-Time Counter
  - 8-bit Pulse Counter
    - Asynchronous pulse counting/quadrature decoding
  - Watchdog Timer with dedicated RC oscillator @ 50 nA
- Communication interfaces
  - 2× Universal Synchronous/Asynchronous Receiver/Transmitter
    - UART/SPI/SmartCard (ISO 7816)/IrDA
    - Triple buffered full/half-duplex operation
    - 4-16 data bits
  - Low Energy UART
    - Autonomous operation with DMA in Deep Sleep Mode
  - I2C Interface with SMBus support
    - Address recognition in Stop Mode
- Ultra low power precision analog peripherals
  - 12-bit 1 Msamples/s Analog to Digital Converter
    - 4 single ended channels/2 differential channels
    - On-chip temperature sensor
    - Conversion tailgating for predictable latency
  - 12-bit 500 ksamples/s Digital to Analog Converter
  - 2× Analog Comparator
    - Programmable speed/current
    - Capacitive sensing with up to 5 inputs
  - Supply Voltage Comparator
- Ultra efficient Power-on Reset and Brown-Out Detector
- 2-pin Serial Wire Debug interface
  - 1-pin Serial Wire Viewer
- Pre-Programmed Serial Bootloader
- Temperature range -40 to 85 °C

- Single power supply 1.8 to 3.8 V

**BLOCK DIAGRAM:**

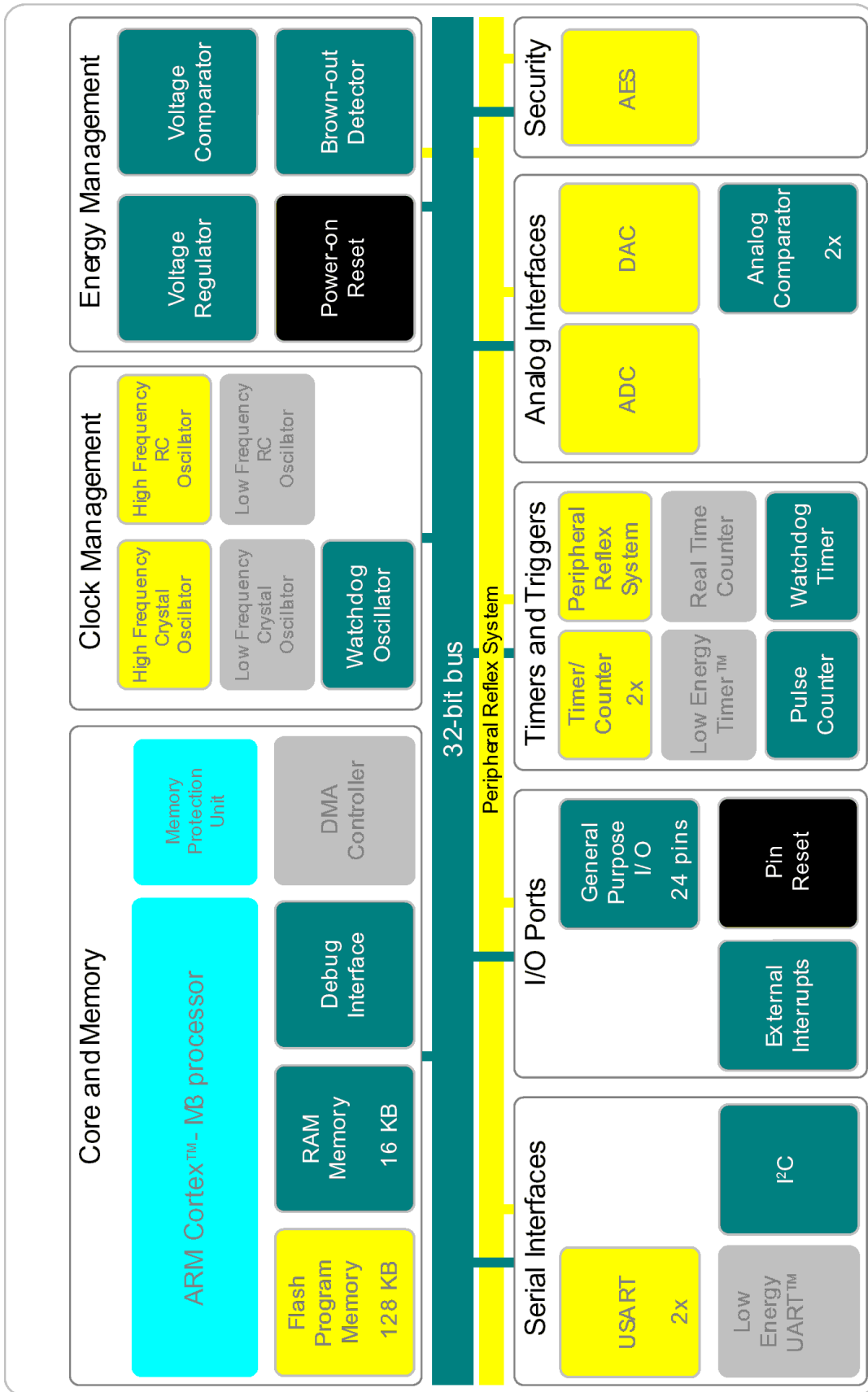

# MEMORY MAP:

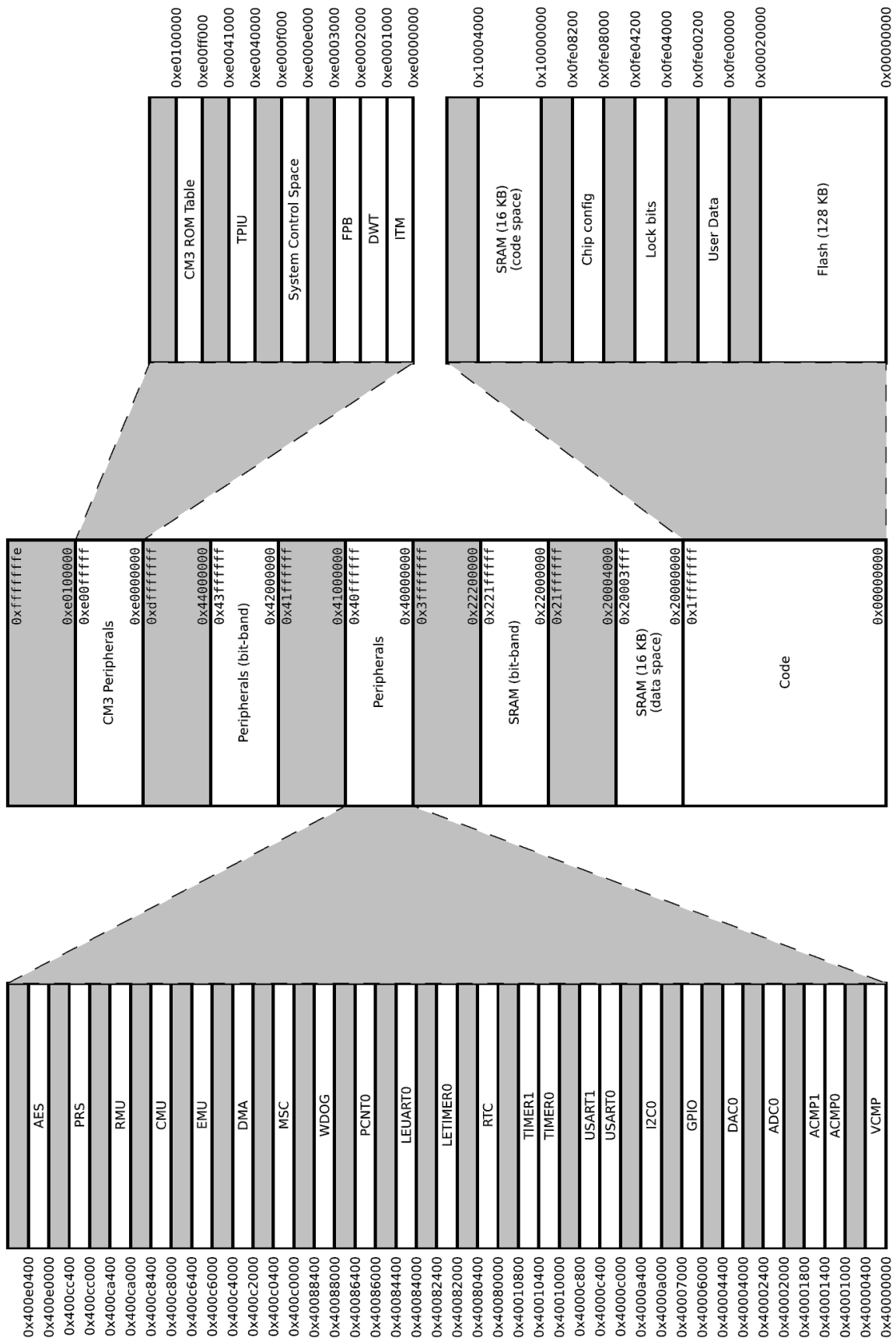

# SCHEMATIC:

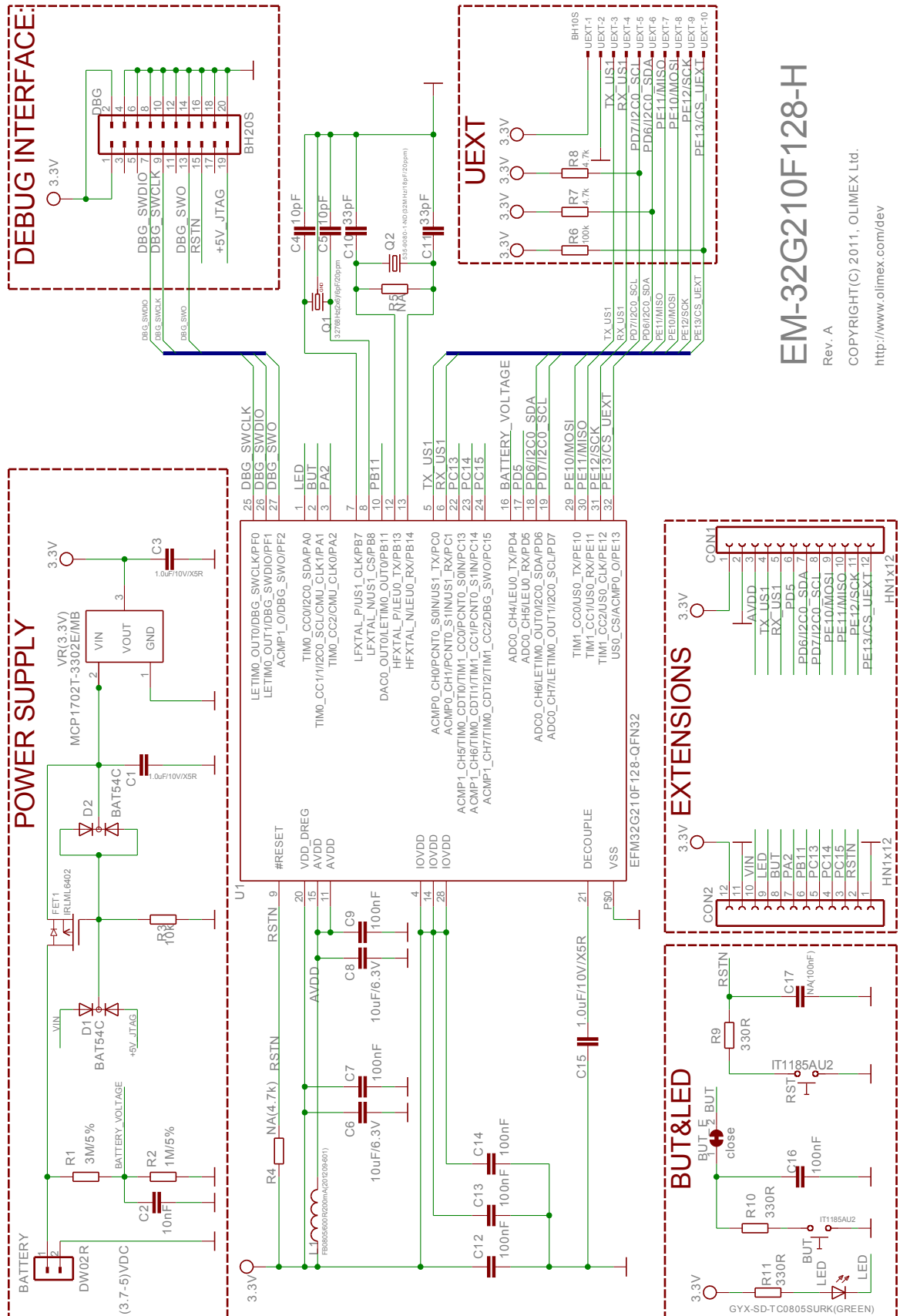

**EM-32G210F128-H**

Rev. A  
 COPYRIGHT(C) 2011, OLIMEX LTD.  
<http://www.olimex.com/dev>



**BOARD LAYOUT:**

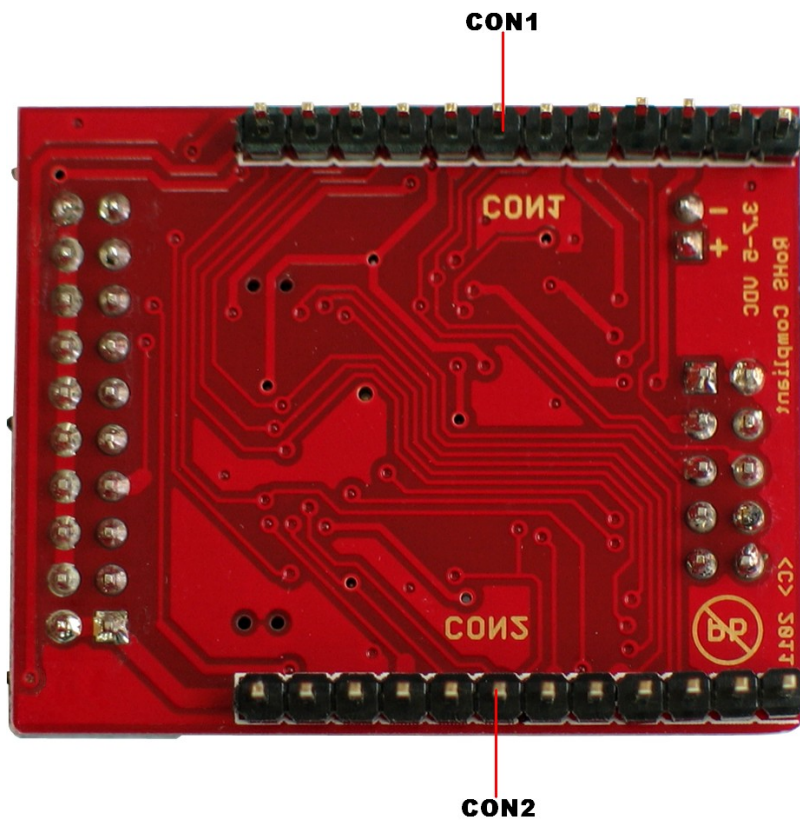
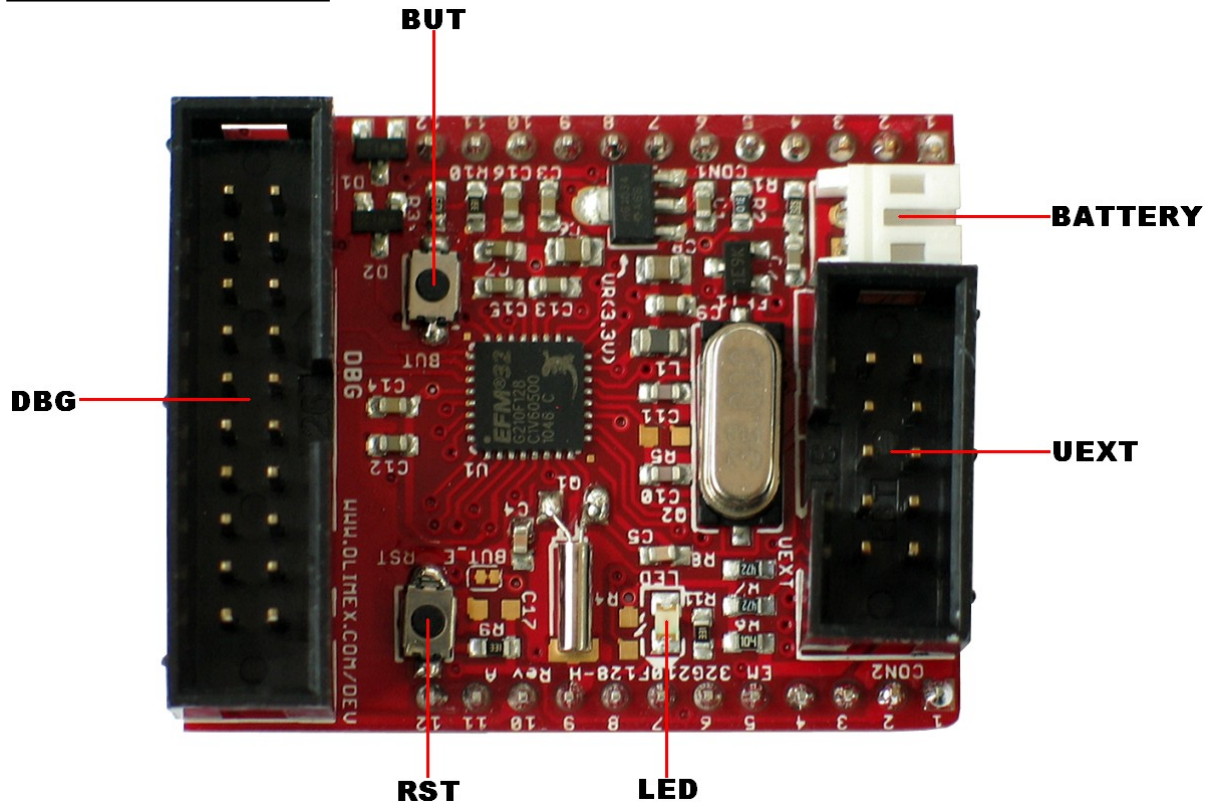

## **POWER SUPPLY CIRCUIT:**

**EM-32G210F128-H** is typically power supplied by Li-ion battery but battery connector allows 3.7-5 VDC.

The board can also be power supplied from extension CON2 pin 10 (VIN - 3.8-6VDC) and pin 11 (GND) and from DBG connector(pin19 - 3.8-6VDC).

The programmed board power consumption is about 7 mA with all peripherals enabled.

## **RESET CIRCUIT:**

**EM-32G210F128-H** reset circuit includes R9 (330Ω), CON2 - pin 2, DBG connector pin 15, EFM32G210F128 pin 9 (#RESET) and RESET button.

## **CLOCK CIRCUIT:**

Quartz crystal **Q1** 32.768 kHz is connected to EFM32G210F128 pin 7 (LFX TAL\_P/US1\_CLK/PB7) and pin 8 (LFX TAL\_N/US1\_CS/PB8).

Quartz crystal **Q2** 32MHz is connected to EFM32G210F128 pin 12 (HFXTAL\_P/LEU0\_TX/PB13) and pin 13 (HFXTAL\_N/LEU0\_RX/PB14).

## **JUMPER DESCRIPTION:**

### **BUT\_E**



This jumper enables the user button - BUT.  
Default state is closed.

## **INPUT/OUTPUT:**

**Status led (green)**, with name **LED**, connected to EFM32G210F128 pin 1 (TIM0\_CC0/I2C0\_SDA/PA0).

**User button** with name **BUT** connected, via BUT\_E, to EFM32G210F128 pin 2 (TIM0\_CC1/1/I2C0\_SCL/CMU\_CLK1/PA1).

**User button** with name **RST** connected to EFM32G210F128 pin 9 (#RESET).

## EXTERNAL CONNECTORS DESCRIPTION:

### CON1:

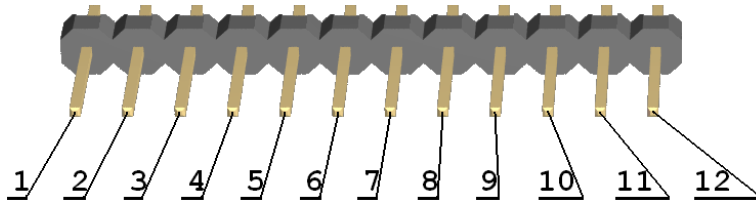

Pin #	Signal Name	Pin #	Signal Name
1	VCC	2	GND
3	AVDD	4	TX_US1
5	RX_US1	6	PD5
7	PD6/I2C0_SDA	8	PD7/I2C0_SCL
9	PE10/MOSI	10	PE11/MISO
11	PE12/SCK	12	PE13/CS_UEXT

### CON2:

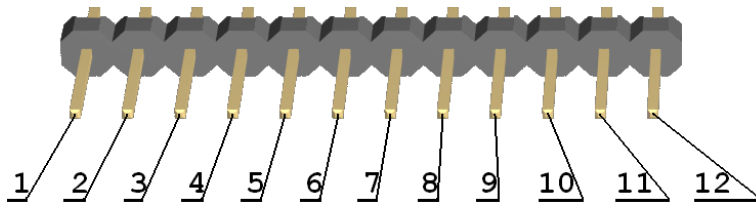

Pin #	Signal Name	Pin #	Signal Name
1	GND	2	RSTN
3	PC15	4	PC14
5	PC13	6	PB11
7	PA2	8	BUT
9	LED	10	VIN
11	GND	12	VCC

### UEXT:

Pin #	Signal Name
1	VCC
2	GND
3	TX_US1
4	RX_US1
5	PD7/I2C0_SCL
6	PD6/I2C0_SDA
7	PE11/MISO
8	PE10/MOSI
9	PE12/SCK
10	PE13/CS_UEXT

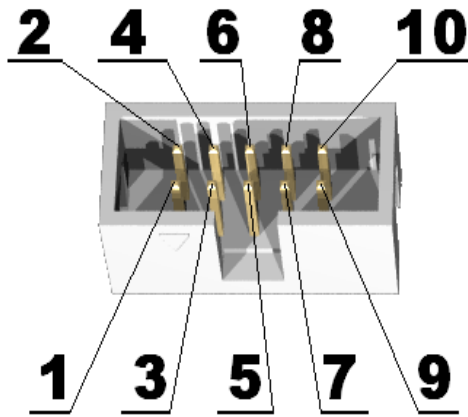

**BATTERY:**

Pin #	Signal Name
1	to VCC
2	GND

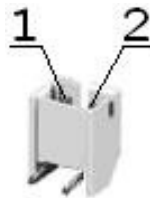

## DBG:

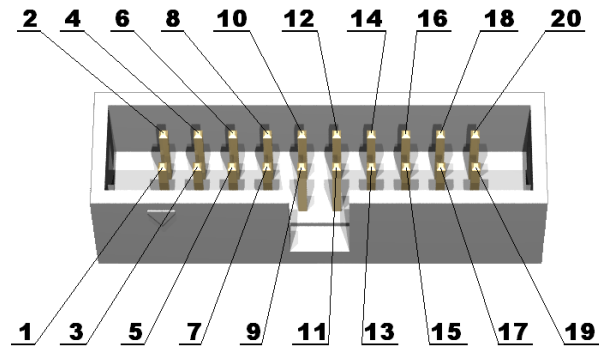

Pin #	Signal Name	Pin #	Signal Name
1	VCC	2	VCC
3	Not connected	4	GND
5	Not connected	6	GND
7	DBG_SWDIO	8	GND
9	DBG_SWCLK	10	GND
11	Not connected	12	GND
13	DBG_SWO	14	GND
15	RSTN	16	GND
17	Not connected	18	GND
19	+5V_JTAG	20	GND

**MECHANICAL DIMENSIONS:**

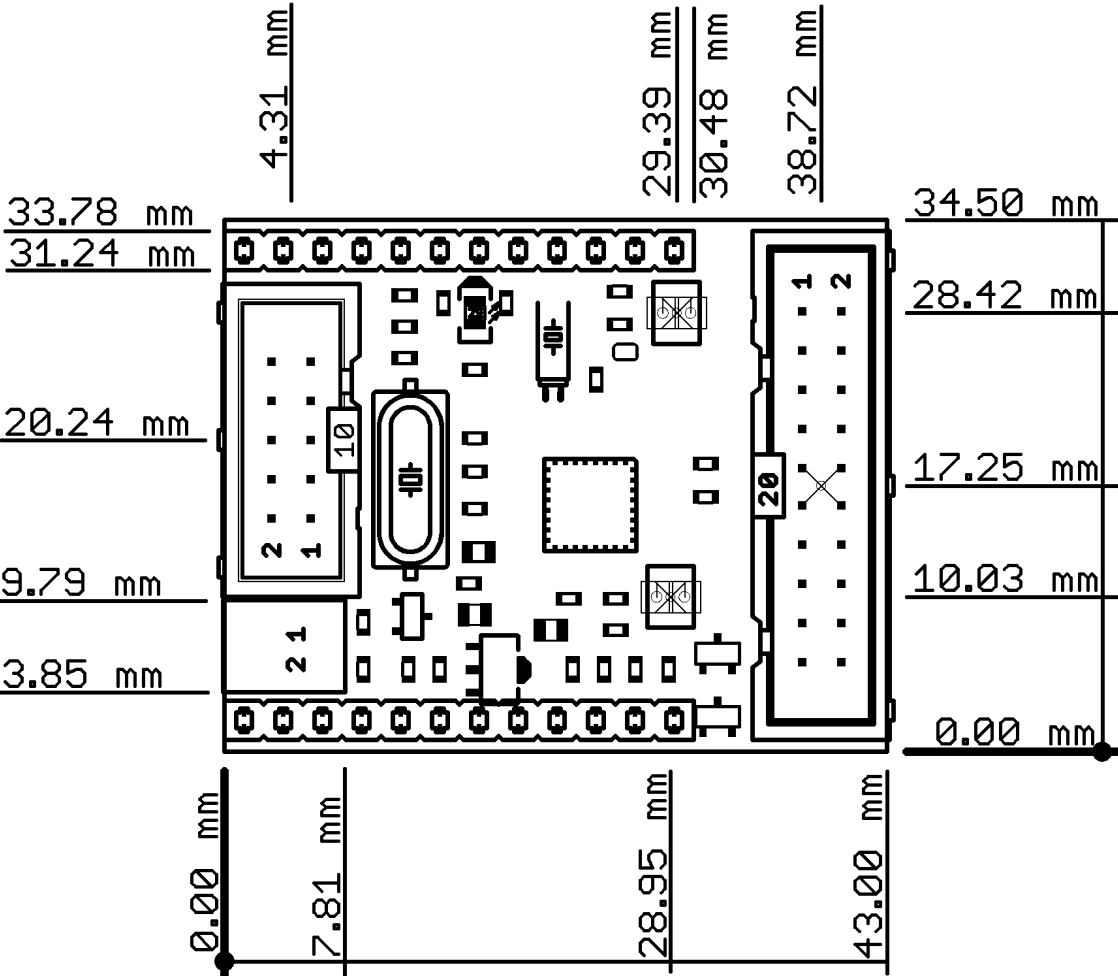

## **AVAILABLE DEMO SOFTWARE:**

- Blinking led

## **ORDER CODE:**

**EM-32G210F128-H** - assembled and tested board

### **How to order?**

You can order to us directly or by any of our distributors.  
Check our web [www.olimex.com/dev](http://www.olimex.com/dev) for more info.

## **Revision history:**

Board's revision:

Rev. A, July 2011

Manual's revision:

Rev. Initial, September 2011