

EFM32G880F128-H development board

Users Manual



All boards produced by Olimex are ROHS compliant

Rev. A, March 2010

Copyright(c) 2010, OLIMEX Ltd, All rights reserved

INTRODUCTION

EFM32G880F128-H header board provides easy way for developing and prototyping with the new EFM32G880F128 energy friendly microcontroller, produced by Energy Micro AS. The combination of the powerful 32-bit ARM Cortex-M3, innovative low energy techniques, short wake-up time from energy saving modes, and a wide selection of peripherals, the EFM32G880F128 microcontroller is well suited for any battery operated application as well as other systems requiring high performance and low-energy consumption.

EFM32G880F128-H has DBG port for programming and debugging, UEXT, user button, RESET button, two status leds, and most of the GPIOs are on extension headers where you can connect your additional circuits.

BOARD FEATURES

- MCU: **EFM32G880F128** 32 bit Cortex-M3™ with 128K Bytes Program Flash, 16K Bytes RAM, 85 GPIO, 8 Channel DMA, 12 bit ADC 1Msps, 3xUART/SPI, 2x low power UART, I2C, 3x 16bit TIMERS, 3x2 CC-PWM, SSC, RTC, WDT, up to 32MHz operation
- standard JTAG connector with ARM 2x10 pin layout for programming/debugging with ARM-JTAG-EW
- UEXT connector
- Power jack
- RESET circuit
- RESET button
- Two status LEDs
- User button
- Battery connector
- On-board voltage regulator 3.3V with up to 250mA current
- Power supply filtering capacitor
- 32 Mhz crystal
- Extension headers for all uC ports + RST and power supply
- PCB: FR-4, 1.5 mm (0,062"), soldermask, silkscreen component print
- Dimensions: 70 x 43 mm (2.75 x 1.7 ")
- Distance between the headers: 25.4 mm (1")

ELECTROSTATIC WARNING

The EFM32G880F128-H board is shipped in protective anti-static packaging. The board must not be subject to high electrostatic potentials. General practice for working with static sensitive devices should be applied when working with this board.

BOARD USE REQUIREMENTS:

Cables: The cable you will need depends on the programmer/debugger you use. If you use ARM-JTAG-EW, you will need 1.8 m A-B USB cable.

Hardware: Programmer/Debugger – Olimex ARM Programmer: ARM-JTAG-EW.

Software: ARM C compiler and JTAG programmer.

PROCESSOR FEATURES

EFM32G880F128-H board use High Performance ARM-based 32-bit microcontroller EFM32G880F128 with these features:

- Memory Protection Unit
- Wake-up Interrupt Controller
- Flexible Energy Management System
 - 20 nA @ 3 V Shutoff Mode
 - 0.6 μ A @ 3 V Stop Mode, including Power-on Reset, Brown-out Detector, RAM and CPU retention
 - 0.9 μ A @ 3 V Deep Sleep Mode, including Real Time Clock with 32.768 kHz oscillator, Power-on Reset, Brown-out Detector, RAM and CPU retention
 - 45 μ A/MHz @ 3 V Sleep Mode
 - 180 μ A/MHz @ 3 V Run Mode, with code executed from flash
- 128 KB Flash
- 16 KB RAM
- 85 General Purpose I/O pins
 - Configurable Push-pull, Open-drain, pull-up/down, input filter, drive strength
 - Configurable peripheral I/O locations
 - 16 asynchronous external interrupts
- 8 Channel DMA Controller
- 8 Channel Peripheral Reflex System for autonomous inter-peripheral signaling
- External Bus Interface for up to 64 MB of external memory mapped space
- Hardware AES with 128/256-bit keys in 54/75 cycles
- Timers/Counters
 - 3 \times 16-bit Timer/Counter
 - 3 \times 3 Compare/Capture/PWM channels

- Dead-Time Insertion on TIMER0
- 16-bit Low Energy Timer
- 24-bit Real-Time Counter
- 3× 8-bit Pulse Counter
 - Asynchronous pulse counting/quadrature decoding
- Watchdog Timer with dedicated RC oscillator @ 50 nA
- Integrated LCD Controller for up to 4×40 segments
 - Voltage boost, adjustable contrast adjustment and autonomous animation feature
- Communication interfaces
 - 3× Universal Synchronous/Asynchronous Receiver/Transmitter
 - UART/SPI/SmartCard (ISO 7816)/IrDA
 - Triple buffered full/half-duplex operation
 - 4-16 data bits
 - Universal Asynchronous Receiver/Transmitter
 - Triple buffered full/half-duplex operation
 - 8-9 data bits
 - 2× Low Energy UART
 - Autonomous operation with DMA in Deep Sleep Mode
 - I²C Interface with SMBus support
 - Address recognition in Stop Mode
- Ultra low power precision analog peripherals
 - 12-bit 1 Msamples/s Analog to Digital Converter
 - Single ended or differential operation
 - On-chip temperature sensor
 - Conversion tailgating for predictable latency
 - 12-bit 500 ksamples/s Digital to Analog Converter
 - 2 single ended channels/1 differential channel
 - 2× Analog Comparator
 - Programmable speed/current
 - Capacitive sensing with up to 8 inputs
 - Supply Voltage Comparator
- Ultra efficient Power-on Reset and Brown-Out Detector
- 2-pin Serial Wire Debug interface
 - 1-pin Serial Wire Viewer
- Temperature range -40 to 85 °C
- Single power supply 1.8 to 3.8 V

BLOCK DIAGRAM

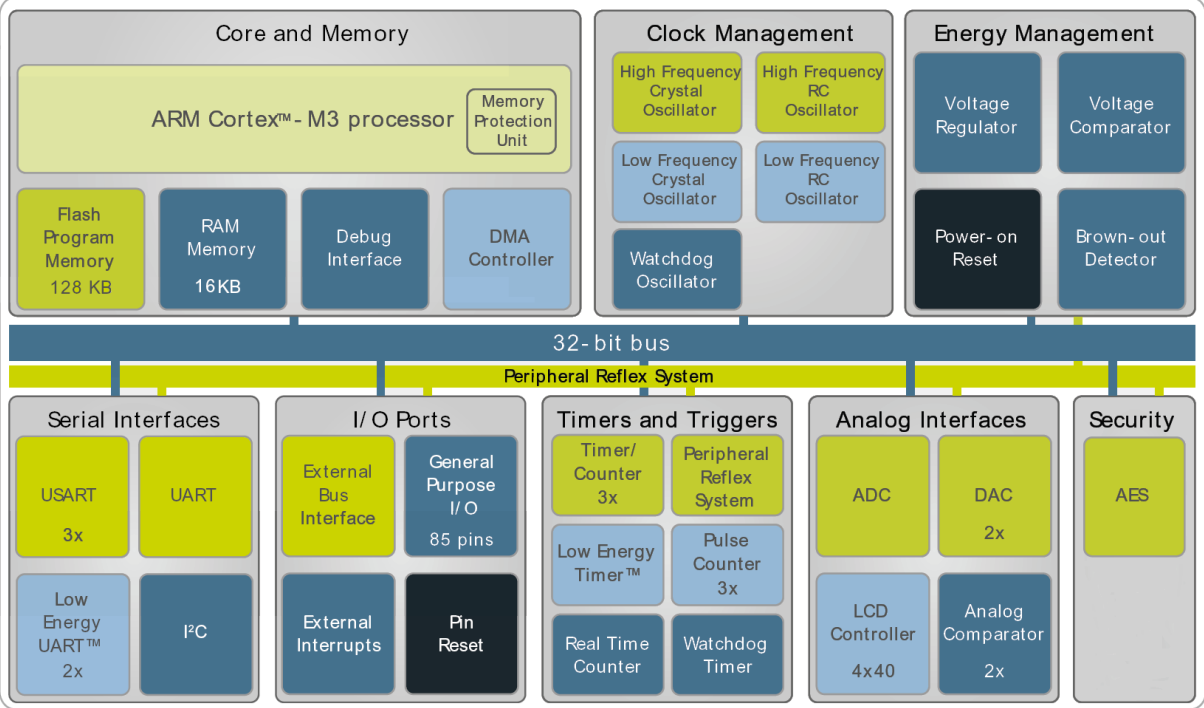

MEMORY MAP

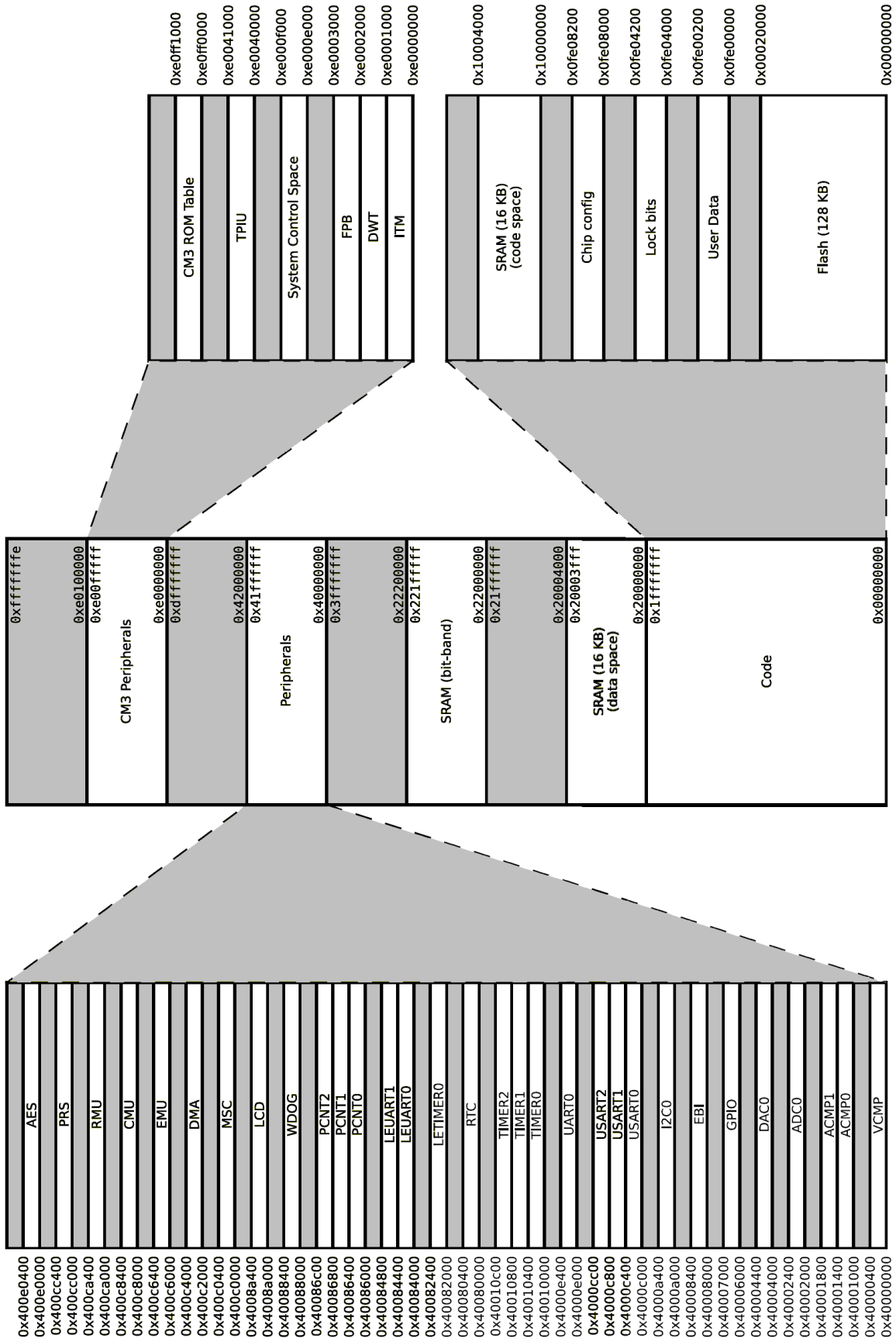

SCHEMATIC

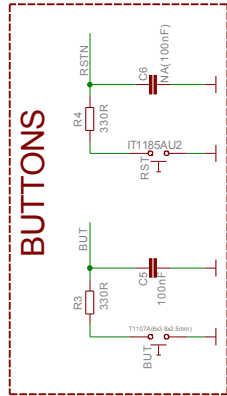
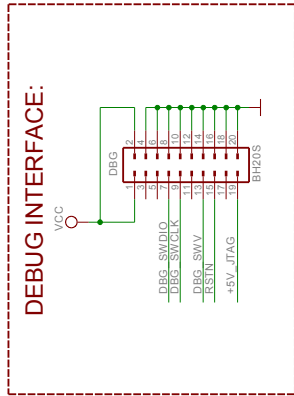
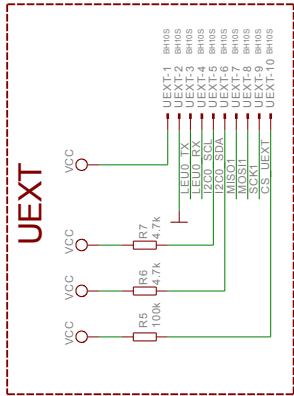

EFM32G880F128-H

Rev. A
COPYRIGHT(C) 2010
WWW.OLIMEX.COM/DEV

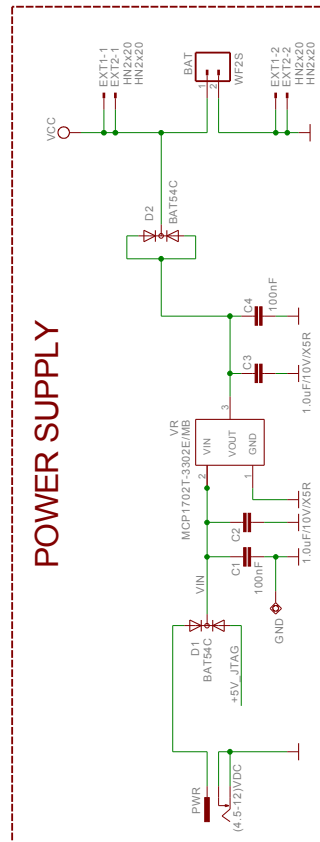
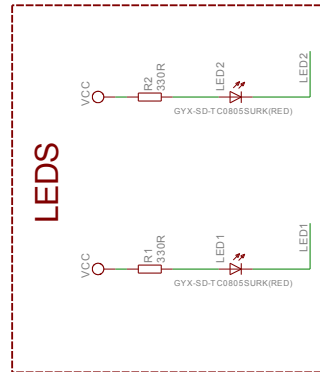
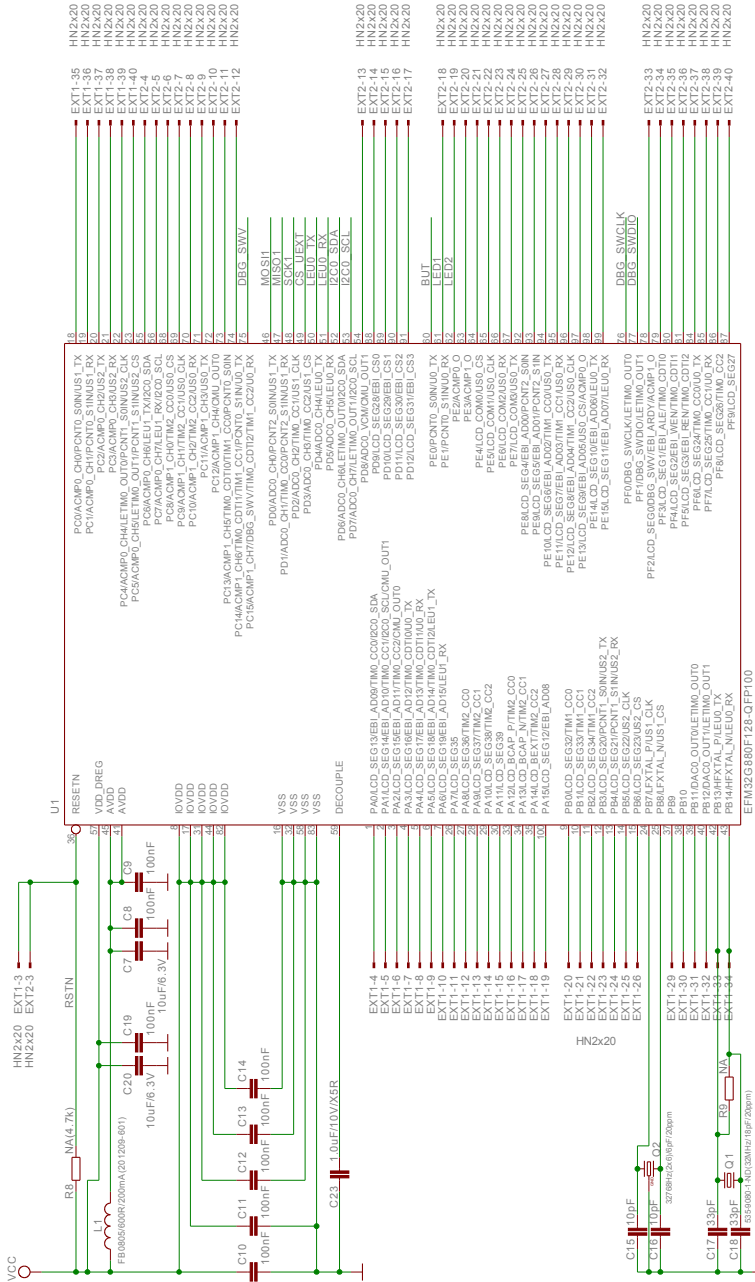

BOARD LAYOUT

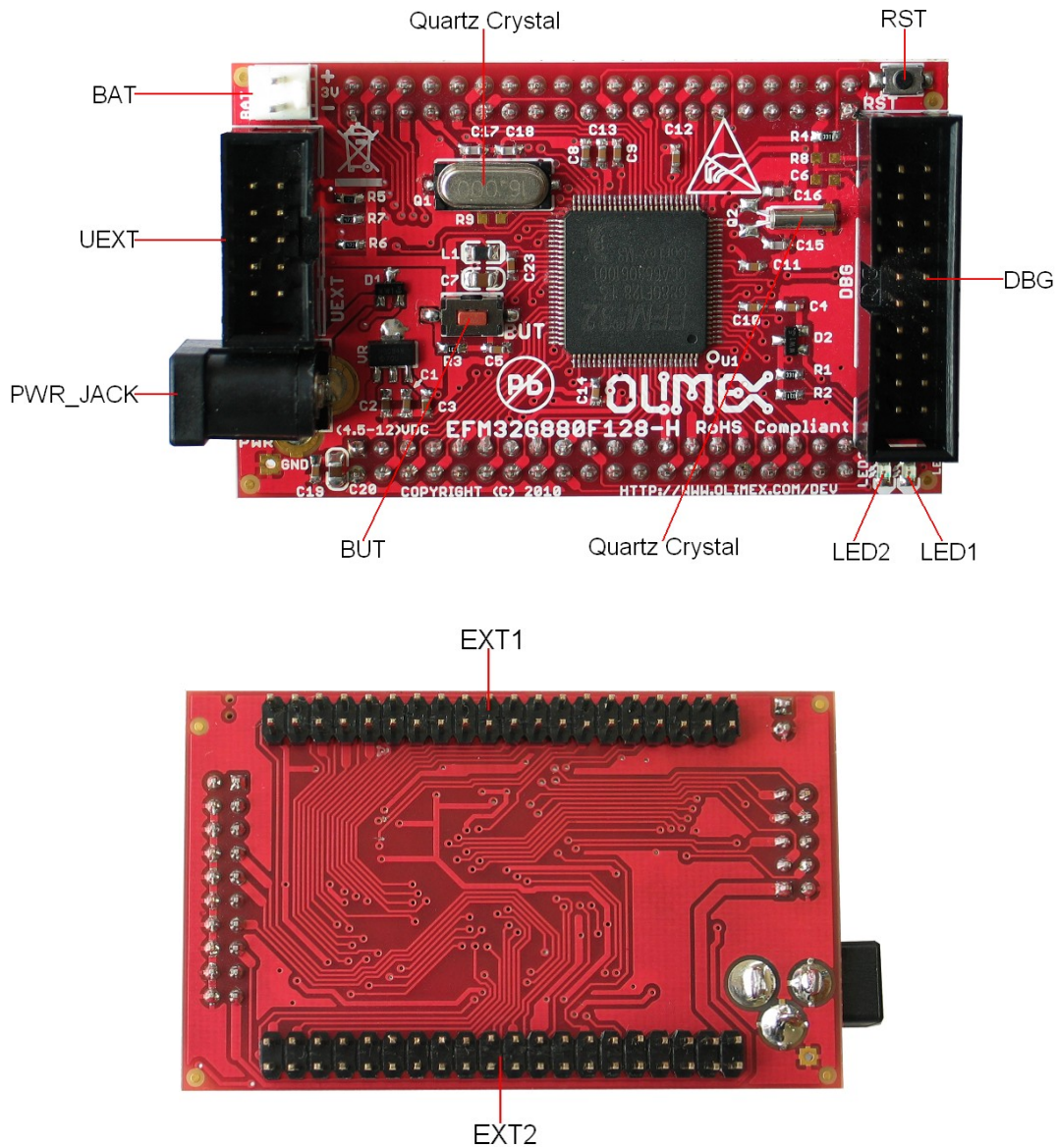

POWER SUPPLY CIRCUIT

EFM32G880F128-H can take power from three sources:

- PWR connector where (4.5 - 12)VDC is applied by external power source.
- +5V_JTAG from DBG connector
- VCC (3V) from BAT connector

RESET CIRCUIT

EFM32G880F128-H reset circuit includes EXT1 pin 3, EXT2 pin 3, DBG connector pin 15, EFM32G880F128 pin 36 (RESETN) and RST button.

CLOCK CIRCUIT

Quartz crystal 32 768 Hz is connected to **EFM32G880F128** pin 24 (PB7/LFXTAL_P/US1_CLK) and pin 25 (PB8/LFXTAL_N/US1_CS).

Quartz crystal 32 MHz is connected to **EFM32G880F128** pin 42 (PB13/HFXTAL_P/LEU0_TX) and pin 43 (PB14/HFXTAL_N/LEU0_RX).

JUMPER DESCRIPTION

There are no jumpers on this board.

INPUT/OUTPUT

Status LED (red) with name **LED1** connected to EFM32G880F128 pin 61 (PE1/PCNT0_S1IN/U0_RX).

Status LED (red) with name **LED2** connected to EFM32G880F128 pin 62 (PE2/ACMP0_O).

User button with name **BUT** connected to EFM32G880F128 pin 60 (PE0/PCNT0_S0IN/U0_TX).

Reset button with name **RST** connected to EFM32G880F128 pin 36 (RESETN).

CONNECTOR DESCRIPTIONS

DBG:

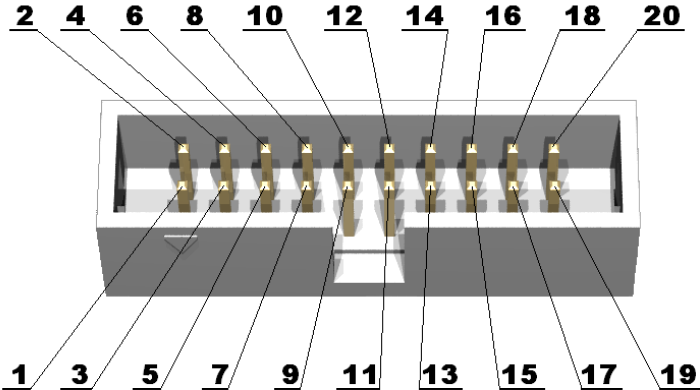

Pin #	Signal Name	Pin #	Signal Name
1	VCC	2	VCC
3	NC	4	GND
5	NC	6	GND
7	DBG_SWDIO	8	GND
9	DBG_SWCLK	10	GND
11	PULL-DOWN	12	GND
13	DBG_SWV	14	GND
15	RSTN	16	GND
17	NC	18	GND
19	+5V_JTAG	20	GND

PWR JACK:

Pin #	Signal Name
1	Power Input
2	GND

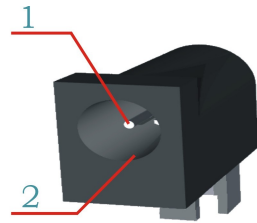

3V BAT

Pin #	Signal Name
1	VCC
2	GND

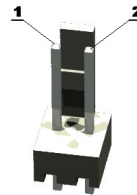

UEXT:

Pin #	Signal Name
1	VCC
2	GND
3	LEU0_TX
4	LEU0_RX
5	I2C0_SCL
6	I2C0_SDA
7	MISO1
8	MOSI1
9	SCK1
10	CS_UEXT

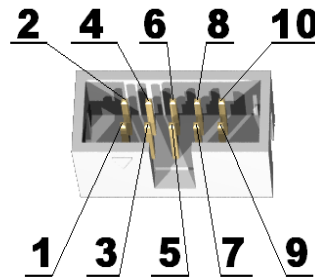

EXT1

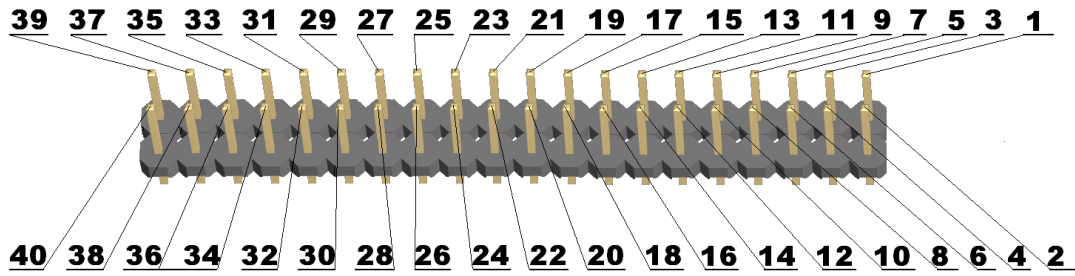

Pin #	Signal Name	Pin #	Signal Name
1	VCC	2	GND
3	RSTN	4	PA0
5	PA1	6	PA2
7	PA3	8	PA4
9	PA5	10	PA6
11	PA7	12	PA8
13	PA9	14	PA10
15	PA11	16	PA12
17	PA13	18	PA14
19	PA15	20	SEG32
21	SEG33	22	SEG34
23	SEG20	24	SEG21
25	SEG22	26	SEG23
27	NC	28	NC
29	PB9	30	PB10
31	PB11	32	PB12
33	PB13	34	PB14
35	PC0	36	PC1
37	PC2	38	PC3
39	PC4	40	PC5

EXT2

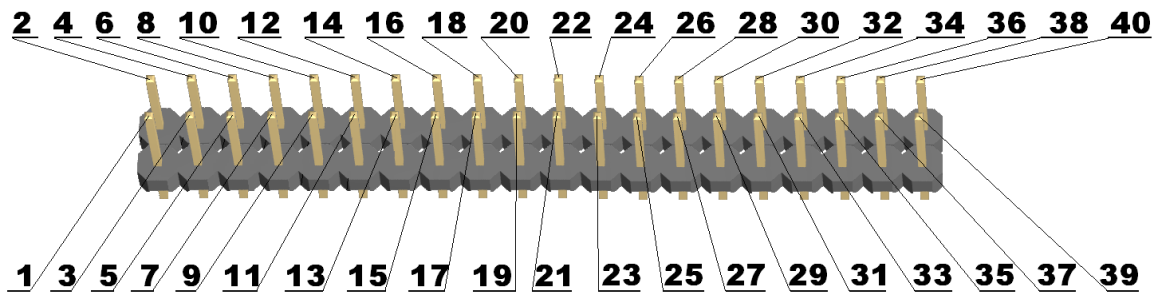

Pin #	Signal Name	Pin #	Signal Name
1	VCC	2	GND
3	RSTN	4	PC6
5	PC7	6	PC8
7	PC9	8	PC10
9	PC11	10	PC12
11	PC13	12	PC14
13	PD8	14	SEG28
15	SEG29	16	SEG30
17	SEG31	18	LED1
19	LED2	20	PE3
21	COM0	22	COM1
23	COM2	24	COM3
25	SEG4	26	SEG5
27	SEG6	28	SEG7
29	SEG8	30	SEG9
31	SEG10	32	SEG11
33	SEG0	34	SEG1
35	SEG2	36	SEG3
37	SEG24	38	SEG25
39	SEG26	40	SEG27

AVAILABLE DEMO SOFTWARE

- [EM-32G880F128-H demo project](#) for EW-ARM 5.41

ORDER CODE

EFM32G880F128-H - assembled and tested board, includes EFM32G880F128 microcontroller

How to order?

You can order to us directly or by any of our distributors.

Check our web www.olimex.com/dev for more info.

Revision history:

REV. A - create March 2010