



Features

- RoHS compliant*
- HCMOS, CMOS and TTL compatible
- Compact package size
- High rotational cycle life
- Standard or high force push switch option
- Optional detent

Additional Information

Click these links for more information:



EM14 – 14 mm Rotary Optical Encoder w/Switch

Electrical Characteristics

Electrical Output	2-bit quadrature code
Resolution	8 to 64 pulses per revolution (PPR)
Supply Voltage (VCC)	5.0 VDC ± 0.25 VDC
Supply Current (ICC)	26 mA maximum
Output Voltage	
Low (VCE(sat)), per Channel	800 mV maximum at I(SINK) = 25 mA
High (VO(HI)), per Channel	4.0 VDC minimum @ VCC = 4.75 VDC
Output Current I(SINK), per Channel	25 mA maximum
Rise/Fall Time	200 ns typical**
Power Dissipation	167 mW maximum
Pulse Width (per Channel)	180 °e typical
Phase Angle (Channel A Leads Channel B, Clockwise Rotation)	90 °e ± 45 °e
Insulation Resistance @ 500 VDC	1,000 megohms minimum
Operating RPM	120 maximum
Switch Power Rating	12 VDC / 20 mA (600 ohms minimum load)
Switch Contact Resistance	200 ohms maximum

Environmental Characteristics

Operating Temperature Range @ 5.0 VDC	-40 °C to +70 °C (-40 °F to +158 °F)
Storage Temperature Range	-55 °C to +125 °C (-67 °F to +257 °F)
Vibration	15 G
Shock	50 G
Humidity	MIL-STD-202, Method 103, Condition B
Flammability	Conforms to UL 94HB
IP Rating	IP 54***

Mechanical Characteristics

Mechanical Angle	360 ° Continuous
Torque	
Starting/Running	1.06 N-cm (1.5 oz.-in.) maximum
Detent	1.2 N-cm (1.7 oz.-in.) typical
Rotational Life	
Non-detent (@ 30 RPM)	1,000,000 cycles (2,000,000 revolutions)
With detent (@ 30 RPM)	100,000 cycles (200,000 revolutions)
Switch Life	100,000 cycles
Switch Actuation Force	
Standard	250 gm (8.82 oz.) typical
High Force	850 gm (29.98 oz.) typical
Switch Travel	
Standard	0.04 in. typical
High Force	0.025 in. typical
Shaft Radial Play	0.005 in. maximum
Shaft Axial Structural Strength	35 lbs. minimum
Mounting Torque	2.0 N-m (18 lb.-in.) maximum

Materials and Finishes

Terminals	Sn plated PC pins
Soldering Condition	
Manual Soldering	96.5Sn/3.0Ag/0.5Cu solid wire or no-clean rosin cored wire 370 °C (700 °F) max. for 3 seconds
Wave Soldering	96.5Sn/3.0Ag/0.5Cu solder with no-clean flux 260 °C (500 °F) max. for 5 seconds
Wash processes	Not recommended
Mounting Hardware	
Nut	Black anodized brass, hex (metric)/Nickel-plated brass, hex (SAE)
Lockwasher	Nickel-plated spring steel, internal tooth
Marking	Manufacturer's symbol, model number, product code, terminal style and date code
Standard Packaging	Anti-static plastic tube (25 pcs./tube)

**See schematic note page 5.

***When device is mounted by normal mounting means.



WARNING Cancer and Reproductive Harm
www.P65Warnings.ca.gov

Specifications are subject to change without notice.

Users should verify actual device performance in their specific applications.

The products described herein and this document are subject to specific legal disclaimers as set forth on the last page of this document, and at www.bourns.com/docs/legal/disclaimer.pdf.

*RoHS Directive 2015/863, Mar 31, 2015 and Annex.

Additional Features

- Splashproof shaft seal
- Recommended for human/machine interface applications (HMI)
- Cable/connector option
- Optional bracket

EM14 – 14 mm Rotary Optical Encoder w/Switch

BOURNS®

Part Numbering System

E M 1 4 A 0 D - C 2 4 - L 0 3 2 S

MODEL NO. DESIGNATOR	
EM14	14 mm Rotary Optical Encoder

BUSHING DESIGNATOR	
Code	Description
A	3/8 " D x 3/8 " L Threaded
C	1/4 " D x 1/4 " L Threaded
R	10 mm D x 9.5 mm L Threaded

DETENT OPTION	
Code	Description
0	No Detent
1	32 Detents (Available for 8 or 32 PPR only)

ANTI-ROTATION LUG/BRAKET OPTION	
Code	Description
A	A/R Lug
B	Bracket (No hardware/no cable or connector)
D	None

SHAFT STYLE (See Outline Drawing for Details)		
Code	Description	Available w/ Bushing
B	1/4 " Dia. Slotted End	A
C	1/4 " Dia. Flatted End	A
E	1/8 " Dia. Slotted End	C
R	6 mm Dia. Slotted End	R
M	6 mm Dia. Flatted End	R

SHAFT LENGTH DESIGNATOR		
Code	Length (FMS)	Available w/Bushing
24	3/4 "	A, C
28	7/8 "	A, C
20	20 mm	R
25	25 mm	R

SWITCH OPTION	
Code	Description
S	Push Switch (Standard)
H	Push Switch (High Force)
N	No Switch

RESOLUTION (Pulses Per Revolution)	
Code	Description
08	8 PPR
16	16 PPR
32	32 PPR
64	64 PPR

CABLE/CONNECTOR OPTION	
Code	Description
0	No Cable/Connector
1	6 " Cable with Female Connector and stripped/tinned leads
2	6 " Cable with Female Connector on both ends
3	12 " Cable with Female Connector and stripped/tinned leads
4	12 " Cable with Female Connector on both ends
5	3 " Cable with Female Connector and stripped/tinned leads
6	1.5 " Cable with Female Connector and stripped/tinned leads
7	2 " Cable with Female Connector and stripped/tinned leads
8	5 " Cable with Female Connector and stripped/tinned leads

Connector options 1~8 are currently available, but not recommended for new designs. See [Product Obsolescence Memo](#).

For other cable and connector options, please contact the factory.

TERMINAL CONFIGURATION	
Code	Description
L	Axial Multi-Purpose Pin
R	Radial Multi-Purpose Pin

Specifications are subject to change without notice.

Users should verify actual device performance in their specific applications.

The products described herein and this document are subject to specific legal disclaimers as set forth on the last page of this document, and at www.bourns.com/docs/legal/disclaimer.pdf.

EM14 – 14 mm Rotary Optical Encoder w/Switch



Product Dimensions



Shaft / Flat Length Dimensions

"A" Style Bushing - Flatted Shafts



SHAFT DIA.	BUSHING DIA.	SHAFT LENGTH	
		"L"	"F"
6.35 (.250)	9.52 (.375)	19.05 (.750)	7.94 (.313)
		22.22 (.875)	9.52 (.375)

"R" Style Bushing - Flatted Shafts



SHAFT DIA.	BUSHING DIA.	SHAFT LENGTH	
		"L"	"F"
6.0 (.236)	10.0 (.394)	20.0 (.787)	7.0 (.275)
		25.0 (.984)	12.0 (.472)

"C" Style Bushing - Slotted Shafts

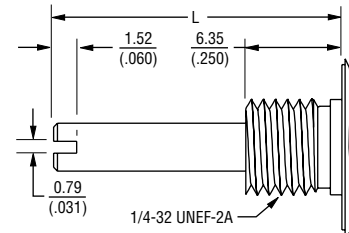

SHAFT DIA.	BUSHING DIA.	SHAFT LENGTH
		"L"
3.17 (.125)	6.35 (.250)	19.05 (.750)
		22.22 (.875)

"A" Style Bushing - Slotted Shafts

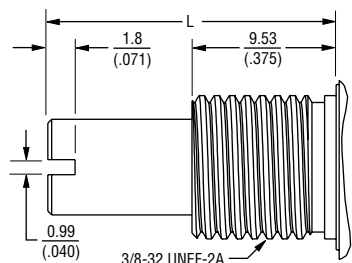

SHAFT DIA.	BUSHING DIA.	SHAFT LENGTH
		"L"
6.35 (.250)	9.52 (.375)	19.05 (.750)
		22.22 (.875)

"R" Style Bushing - Slotted Shafts



SHAFT DIA.	BUSHING DIA.	SHAFT LENGTH
		"L"
6.0 (.236)	10.0 (.394)	20.0 (.787)
		25.0 (.984)

DIMENSIONS: $\frac{\text{MM}}{\text{(INCHES)}}$

Specifications are subject to change without notice.

Users should verify actual device performance in their specific applications.

The products described herein and this document are subject to specific legal disclaimers as set forth on the last page of this document, and at www.bourns.com/docs/legal/disclaimer.pdf.

EM14 – 14 mm Rotary Optical Encoder w/Switch

BOURNS®

Cable/Connector Options

Cable Assembly, Connector on One End



Cable Assembly, Connector on Both Ends



HDW. NO.	DESCRIPTION	"A" DIM.
H-290-1	CABLE ASSEMBLY, CONNECTOR ON BOTH ENDS	152.4 ± 5.0 (6.0 ± .197)
H-290-2	CABLE ASSEMBLY, CONNECTOR ON ONE END	304.8 ± 5.0 (12.0 ± .197)
H-290-3	CABLE ASSEMBLY, CONNECTOR ON BOTH ENDS	304.8 ± 5.0 (12.0 ± .197)
H-290-4	CABLE ASSEMBLY, CONNECTOR ON ONE END	152.4 ± 5.0 (6.0 ± .197)
H-290-5	RIBBON CABLE, 28 AWG, CONNECTOR ON ONE END	76.2 ± 5.0 (3.0 ± .197)
H-290-6	RIBBON CABLE, 28 AWG, CONNECTOR ON ONE END	38.1 ± 5.0 (1.5 ± .197)
H-290-7	RIBBON CABLE, 28 AWG, CONNECTOR ON ONE END	50.8 ± 5.0 (2.0 ± .197)
H-290-8	RIBBON CABLE, 28 AWG, CONNECTOR ON ONE END	127 ± 5.0 (5.0 ± .197)

Terminal Configurations

Radial (shown with optional mounting bracket)

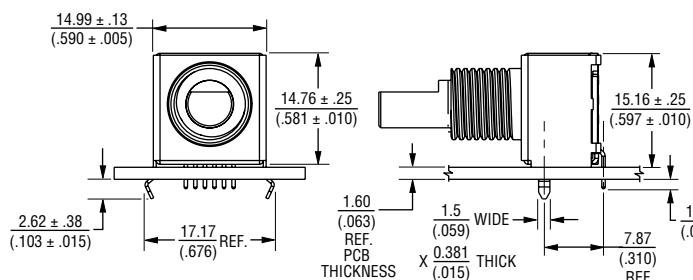

Recommended PCB Layout

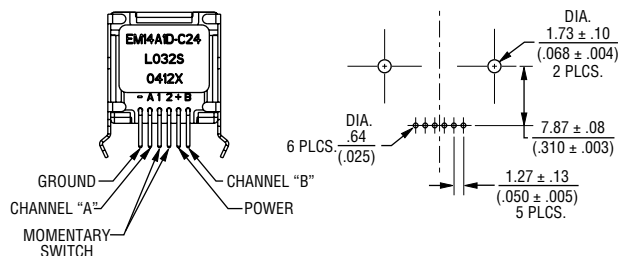

Axial (shown with optional mounting bracket)

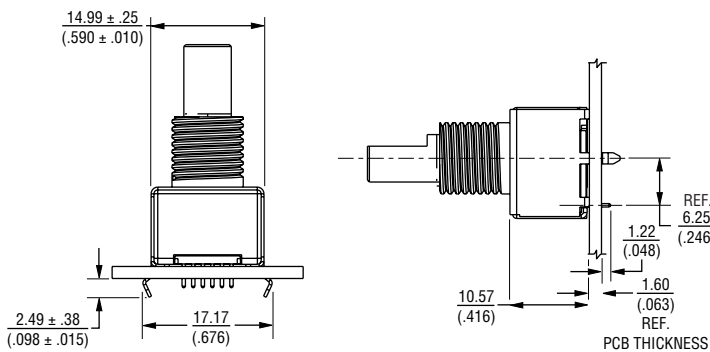

Recommended PCB Layout

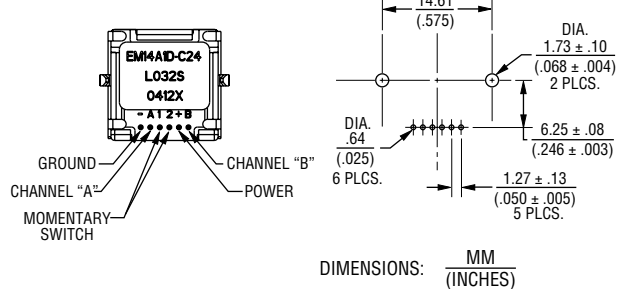

Specifications are subject to change without notice.

Users should verify actual device performance in their specific applications.

The products described herein and this document are subject to specific legal disclaimers as set forth on the last page of this document, and at www.bourns.com/docs/legal/disclaimer.pdf.

EM14 – 14 mm Rotary Optical Encoder w/Switch



14 mm Optical Encoder Electrical Diagram



*External pull-up resistors (1K ohms) and filter caps (22 nF) recommended for proper operation. Utilization of a filter circuit will yield a typical rise time of 50 microseconds. See schematic.

Terminal Diagram



Quadrature Output



32 DETENT / 8 PPR

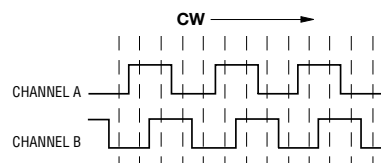

32 DETENT / 32 PPR

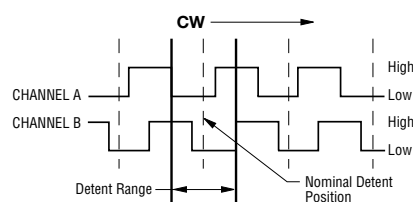

1. Nominal detent position occurs when both Channel A and B are in low states.
2. Channel A leads Channel B in CW direction and lags in CCW direction.



Asia-Pacific: Tel: +886-2 2562-4117 • Email: asiacus@bourns.com

Europe: Tel: +36 88 885 877 • Email: eurocus@bourns.com

The Americas: Tel: +1-951 781-5500 • Email: americus@bourns.com

www.bourns.com

REV. 09/21

Specifications are subject to change without notice.

Users should verify actual device performance in their specific applications.

The products described herein and this document are subject to specific legal disclaimers as set forth on the last page of this document, and at www.bourns.com/docs/legal/disclaimer.pdf.