



## Features

- RoHS compliant\*
- HCMOS, CMOS and TTL compatible
- Compact package size
- High rotational cycle life
- Standard or high force push switch option
- Optional detent

## Additional Information

Click these links for more information:



[PRODUCT](#)



[TECHNICAL LIBRARY](#)



[INVENTORY](#)



[SAMPLES](#)



[CONTACT](#)

# EM14 – 14 mm Rotary Optical Encoder w/Switch

## Electrical Characteristics

Electrical Output .....	2-bit quadrature code
Resolution .....	8 to 64 pulses per revolution (PPR)
Supply Voltage (VCC) .....	5.0 VDC ± 0.25 VDC
Supply Current (ICC) .....	26 mA maximum
Output Voltage	
Low (VCE(sat)), per Channel .....	800 mV maximum at I(SINK) = 25 mA
High (VO(HI)), per Channel .....	4.0 VDC minimum @ VCC = 4.75 VDC
Output Current I(SINK), per Channel .....	25 mA maximum
Rise/Fall Time .....	200 ns typical**
Power Dissipation .....	167 mW maximum
Pulse Width (per Channel) .....	180 °e typical
Phase Angle (Channel A Leads Channel B, Clockwise Rotation) .....	90 °e ± 45 °e
Insulation Resistance @ 500 VDC .....	1,000 megohms minimum
Operating RPM .....	120 maximum
Switch Power Rating .....	12 VDC / 20 mA (600 ohms minimum load)
Switch Contact Resistance .....	200 ohms maximum

## Environmental Characteristics

Operating Temperature Range @ 5.0 VDC .....	-40 °C to +70 °C (-40 °F to +158 °F)
Storage Temperature Range .....	-55 °C to +125 °C (-67 °F to +257 °F)
Vibration .....	15 G
Shock .....	50 G
Humidity .....	MIL-STD-202, Method 103, Condition B
Flammability .....	Conforms to UL 94HB
IP Rating .....	IP 54***

## Mechanical Characteristics

Mechanical Angle .....	360 ° Continuous
Torque	
Starting/Running .....	1.06 N-cm (1.5 oz.-in.) maximum
Detent .....	1.2 N-cm (1.7 oz.-in.) typical
Rotational Life	
Non-detent (@ 30 RPM) .....	1,000,000 cycles (2,000,000 revolutions)
With detent (@ 30 RPM) .....	100,000 cycles (200,000 revolutions)
Switch Life .....	100,000 cycles
Switch Actuation Force	
Standard .....	250 gm (8.82 oz.) typical
High Force .....	850 gm (29.98 oz.) typical
Switch Travel	
Standard .....	0.04 in. typical
High Force .....	0.025 in. typical
Shaft Radial Play .....	0.005 in. maximum
Shaft Axial Structural Strength .....	35 lbs. minimum
Mounting Torque .....	2.0 N-m (18 lb.-in.) maximum

## Materials and Finishes

Terminals .....	Sn plated PC pins
Soldering Condition	
Manual Soldering .....	96.5Sn/3.0Ag/0.5Cu solid wire or no-clean rosin cored wire 370 °C (700 °F) max. for 3 seconds
Wave Soldering .....	96.5Sn/3.0Ag/0.5Cu solder with no-clean flux 260 °C (500 °F) max. for 5 seconds
Wash processes .....	Not recommended
Mounting Hardware	
Nut .....	Black anodized brass, hex (metric)/Nickel-plated brass, hex (SAE)
Lockwasher .....	Nickel-plated spring steel, internal tooth
Marking .....	Manufacturer's symbol, model number, product code, terminal style and date code
Standard Packaging .....	Anti-static plastic tube (25 pcs./tube)

\*\*See schematic note page 5.

\*\*\*When device is mounted by normal mounting means.



**WARNING Cancer and Reproductive Harm**  
[www.P65Warnings.ca.gov](http://www.P65Warnings.ca.gov)

Specifications are subject to change without notice.

Users should verify actual device performance in their specific applications.

The products described herein and this document are subject to specific legal disclaimers as set forth on the last page of this document, and at [www.bourns.com/docs/legal/disclaimer.pdf](http://www.bourns.com/docs/legal/disclaimer.pdf).

\*RoHS Directive 2015/863, Mar 31, 2015 and Annex.

## Additional Features

- Splashproof shaft seal
- Recommended for human/machine interface applications (HMI)
- Cable/connector option
- Optional bracket

# EM14 – 14 mm Rotary Optical Encoder w/Switch

**BOURNS®**

## Part Numbering System

**E M 1 4 A 0 D - C 2 4 - L 0 3 2 S**

MODEL NO. DESIGNATOR	
EM14	14 mm Rotary Optical Encoder

BUSHING DESIGNATOR	
Code	Description
A	3/8 " D x 3/8 " L Threaded
C	1/4 " D x 1/4 " L Threaded
R	10 mm D x 9.5 mm L Threaded

DETENT OPTION	
Code	Description
0	No Detent
1	32 Detents (Available for 8 or 32 PPR only)

ANTI-ROTATION LUG/BRAKET OPTION	
Code	Description
A	A/R Lug
B	Bracket (No hardware/no cable or connector)
D	None

SHAFT STYLE (See Outline Drawing for Details)		
Code	Description	Available w/ Bushing
B	1/4 " Dia. Slotted End	A
C	1/4 " Dia. Flatted End	A
E	1/8 " Dia. Slotted End	C
R	6 mm Dia. Slotted End	R
M	6 mm Dia. Flatted End	R

SHAFT LENGTH DESIGNATOR		
Code	Length (FMS)	Available w/Bushing
24	3/4 "	A, C
28	7/8 "	A, C
20	20 mm	R
25	25 mm	R

SWITCH OPTION	
Code	Description
S	Push Switch (Standard)
H	Push Switch (High Force)
N	No Switch

RESOLUTION (Pulses Per Revolution)	
Code	Description
08	8 PPR
16	16 PPR
32	32 PPR
64	64 PPR

CABLE/CONNECTOR OPTION	
Code	Description
0	No Cable/Connector
1	6 " Cable with Female Connector and stripped/tinned leads
2	6 " Cable with Female Connector on both ends
3	12 " Cable with Female Connector and stripped/tinned leads
4	12 " Cable with Female Connector on both ends
5	3 " Cable with Female Connector and stripped/tinned leads
6	1.5 " Cable with Female Connector and stripped/tinned leads
7	2 " Cable with Female Connector and stripped/tinned leads
8	5 " Cable with Female Connector and stripped/tinned leads

Connector options 1~8 are currently available, but not recommended for new designs. See [Product Obsolescence Memo](#).

For other cable and connector options, please contact the factory.

TERMINAL CONFIGURATION	
Code	Description
L	Axial Multi-Purpose Pin
R	Radial Multi-Purpose Pin

Specifications are subject to change without notice.

Users should verify actual device performance in their specific applications.

The products described herein and this document are subject to specific legal disclaimers as set forth on the last page of this document, and at [www.bourns.com/docs/legal/disclaimer.pdf](http://www.bourns.com/docs/legal/disclaimer.pdf).

# EM14 – 14 mm Rotary Optical Encoder w/Switch



## Product Dimensions



## Shaft / Flat Length Dimensions

"A" Style Bushing - Flatted Shafts



SHAFT DIA.	BUSHING DIA.	SHAFT LENGTH "L"	FLAT LENGTH "F"
6.35 (.250)	9.52 (.375)	19.05 (.750)	7.94 (.313)
		22.22 (.875)	9.52 (.375)

"R" Style Bushing - Flatted Shafts



SHAFT DIA.	BUSHING DIA.	SHAFT LENGTH "L"	FLAT LENGTH "F"
6.0 (.236)	10.0 (.394)	20.0 (.787)	7.0 (.275)
		25.0 (.984)	12.0 (.472)

"C" Style Bushing - Slotted Shafts

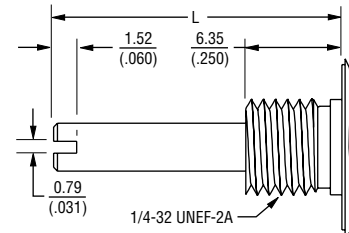

SHAFT DIA.	BUSHING DIA.	SHAFT LENGTH "L"
3.17 (.125)	6.35 (.250)	19.05 (.750)
		22.22 (.875)

"A" Style Bushing - Slotted Shafts



SHAFT DIA.	BUSHING DIA.	SHAFT LENGTH "L"
6.35 (.250)	9.52 (.375)	19.05 (.750)
		22.22 (.875)

"R" Style Bushing - Slotted Shafts



SHAFT DIA.	BUSHING DIA.	SHAFT LENGTH "L"
6.0 (.236)	10.0 (.394)	20.0 (.787)
		25.0 (.984)

DIMENSIONS:  $\frac{\text{MM}}{\text{(INCHES)}}$

Specifications are subject to change without notice.

Users should verify actual device performance in their specific applications.

The products described herein and this document are subject to specific legal disclaimers as set forth on the last page of this document, and at [www.bourns.com/docs/legal/disclaimer.pdf](http://www.bourns.com/docs/legal/disclaimer.pdf).

# EM14 – 14 mm Rotary Optical Encoder w/Switch

**BOURNS®**

## Cable/Connector Options

### Cable Assembly, Connector on One End



### Cable Assembly, Connector on Both Ends



HDW. NO.	DESCRIPTION	"A" DIM.
H-290-1	CABLE ASSEMBLY, CONNECTOR ON BOTH ENDS	152.4 ± 5.0 (6.0 ± .197)
H-290-2	CABLE ASSEMBLY, CONNECTOR ON ONE END	304.8 ± 5.0 (12.0 ± .197)
H-290-3	CABLE ASSEMBLY, CONNECTOR ON BOTH ENDS	304.8 ± 5.0 (12.0 ± .197)
H-290-4	CABLE ASSEMBLY, CONNECTOR ON ONE END	152.4 ± 5.0 (6.0 ± .197)
H-290-5	RIBBON CABLE, 28 AWG, CONNECTOR ON ONE END	76.2 ± 5.0 (3.0 ± .197)
H-290-6	RIBBON CABLE, 28 AWG, CONNECTOR ON ONE END	38.1 ± 5.0 (1.5 ± .197)
H-290-7	RIBBON CABLE, 28 AWG, CONNECTOR ON ONE END	50.8 ± 5.0 (2.0 ± .197)
H-290-8	RIBBON CABLE, 28 AWG, CONNECTOR ON ONE END	127 ± 5.0 (5.0 ± .197)

## Terminal Configurations

### Radial (shown with optional mounting bracket)

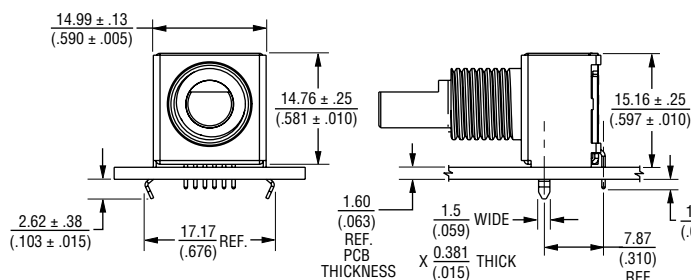

### Recommended PCB Layout

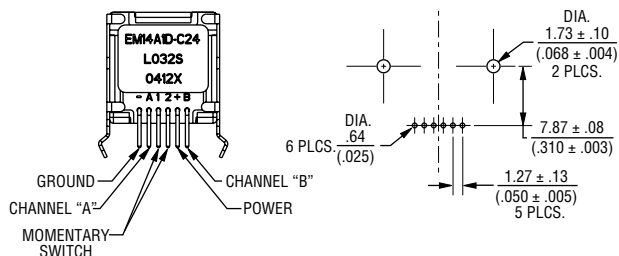

### Axial (shown with optional mounting bracket)

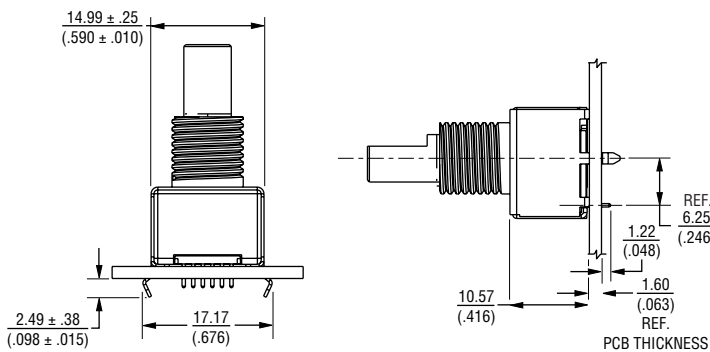

### Recommended PCB Layout

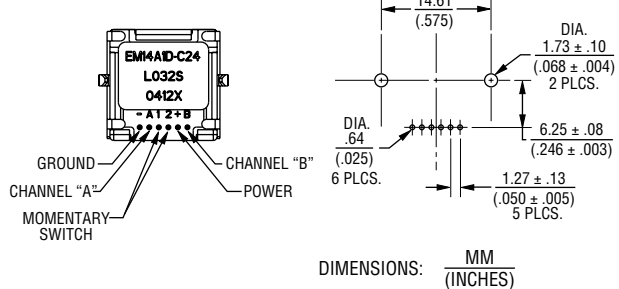

Specifications are subject to change without notice.

Users should verify actual device performance in their specific applications.

The products described herein and this document are subject to specific legal disclaimers as set forth on the last page of this document, and at [www.bourns.com/docs/legal/disclaimer.pdf](http://www.bourns.com/docs/legal/disclaimer.pdf).

# EM14 – 14 mm Rotary Optical Encoder w/Switch



## 14 mm Optical Encoder Electrical Diagram



\*External pull-up resistors (1K ohms) and filter caps (22 nF) recommended for proper operation. Utilization of a filter circuit will yield a typical rise time of 50 microseconds. See schematic.

## Terminal Diagram



## Quadrature Output

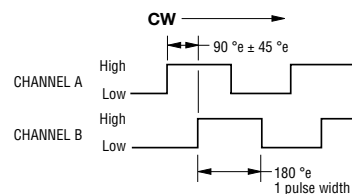

## 32 DETENT / 8 PPR

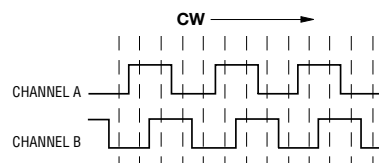

## 32 DETENT / 32 PPR

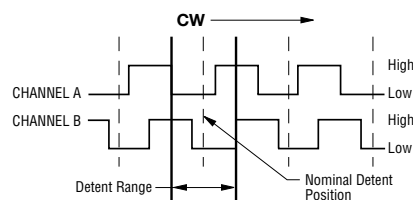

1. Nominal detent position occurs when both Channel A and B are in low states.
2. Channel A leads Channel B in CW direction and lags in CCW direction.



Asia-Pacific: Tel: +886-2 2562-4117 • Email: asiacus@bourns.com

Europe: Tel: +36 88 885 877 • Email: eurocus@bourns.com

The Americas: Tel: +1-951 781-5500 • Email: americus@bourns.com

[www.bourns.com](http://www.bourns.com)

REV. 09/21

Specifications are subject to change without notice.

Users should verify actual device performance in their specific applications.

The products described herein and this document are subject to specific legal disclaimers as set forth on the last page of this document, and at [www.bourns.com/docs/legal/disclaimer.pdf](http://www.bourns.com/docs/legal/disclaimer.pdf).