



## Features

- Two channel quadrature output
- Bushing or servo mount
- Square wave signal
- Small size
- Resolution to 256 PPR
- CMOS and TTL compatible
- Long life
- Ball bearing option for high operating speed up to 3000 rpm
- RoHS compliant\*

## EN - Rotary Optical Encoder

### Electrical Characteristics

Output .....	2-bit quadrature code, Channel A leads Channel B by 90° (electrical) with clockwise rotation
Resolution .....	25 to 256 cycles per revolution
Insulation Resistance (500 VDC) .....	1,000 megohms
Electrical Travel .....	Continuous
Supply Voltage .....	5.0 VDC ±0.25 VDC
Supply Current .....	26 mA maximum
Output Voltage	
Low Output .....	0.8 V maximum
High Output .....	4 V minimum
Output Current	
Low Output .....	25 mA minimum
Rise/Fall Time .....	200 ns (typical)
Shaft RPM (Ball Bearing) .....	3,000 rpm maximum
Power Consumption .....	136 mW maximum
Pulse Width (Electrical Degrees, Each Channel) .....	180° ±45° typ.
Pulse Width (Index Channel) .....	360° ±90°
Phase (Electrical Degrees, Channel A to Channel B) .....	90° ±45° typ.

### Environmental Characteristics

Operating Temperature Range .....	-40 °C to +75 °C (-40 °F to +167 °F)
Storage Temperature Range .....	-40 °C to +85 °C (-40 °F to +185 °F)
Humidity .....	MIL-STD-202, Method 103B, Condition B
Vibration .....	5 G
Shock .....	50 G
Rotational Life	
A & C Bushings (300 rpm maximum)** .....	10,000,000 revolutions
W, S & T Bushings (3,000 rpm maximum)** .....	200,000,000 revolutions
IP Rating .....	IP 40

### Mechanical Characteristics

Mechanical Angle .....	360° Continuous
Torque (Starting and Running)	
A & C Bushings (Spring Loaded for Optimum Feel) .....	1 N-cm (1.5 oz-in.) maximum
W, S & T Bushings (Ball Bearing Shaft Support) .....	0.07 N-cm (0.1 oz-in.) maximum
Mounting Torque .....	1.7 to 2.0 N-cm (15 to 18 lb.-in.) maximum
Shaft End Play .....	0.30 mm (0.012") T.I.R. maximum
Shaft Radial Play .....	0.12 mm (0.005") T.I.R. maximum
Weight .....	11 gms. (0.4 oz.)
Terminals .....	Axial or radial pc pins or ribbon cable
Soldering Condition	
Manual Soldering .....	96.5Sn/3.0Ag/0.5Cu solid wire or no-clean rosin cored wire 370 °C (700 °F) max. for 3 seconds
Wave Soldering .....	96.5Sn/3.0Ag/0.5Cu solder with no-clean flux 260 °C (500 °F) max. for 5 seconds
Wash processes .....	Not recommended
Marking .....	Manufacturer's trademark, name, part number, and date code.
Hardware .....	One lockwasher and one mounting nut supplied with each encoder, except on servo mount versions.

\*\*For resolutions ≤ 128 quadrature cycles per shaft revolution.

### Quadrature Output Table

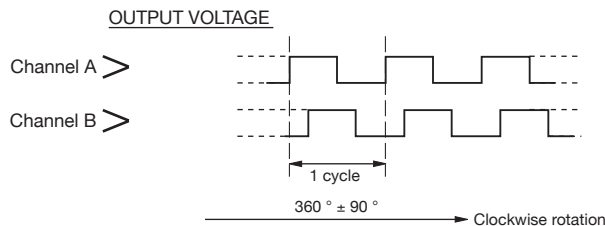

#### STANDARD RESOLUTIONS AVAILABLE

(Full quadrature output cycles per shaft revolution)	
25*	125
50*	128
64	200
100	256

For Non-Standard Resolutions—Consult Factory

\* Channel B leads Channel A

# EN - Rotary Optical Encoder

## Dimensional Drawings

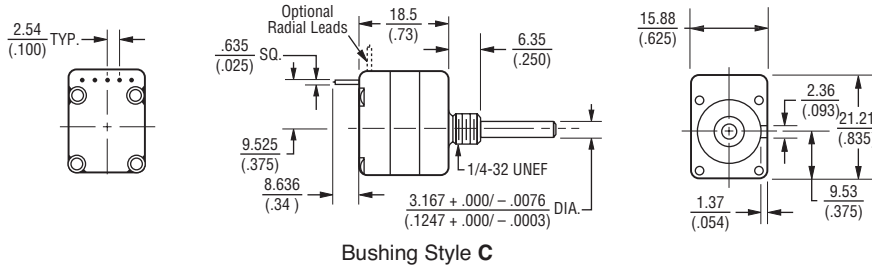

Consult factory for options not shown, including:

- Wire lead or cable options
- Connectors
- Non-standard resolutions
- Special shaft/bushing sizes and features
- Special performance characteristics
- PCB mounting bracket

Bushing Style C

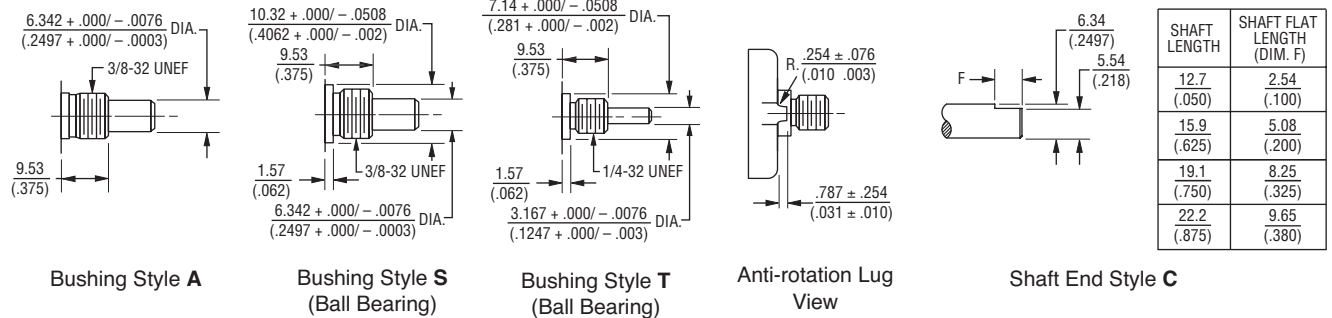

Bushing Style A

Bushing Style S (Ball Bearing)

Bushing Style T (Ball Bearing)

Anti-rotation Lug View

Shaft End Style C

## TERMINATION DIAGRAM

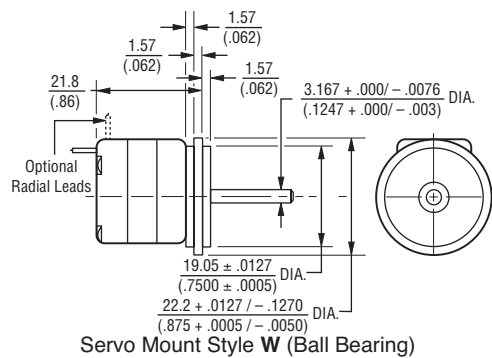
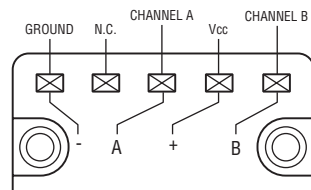

Servo Mount Style W (Ball Bearing)

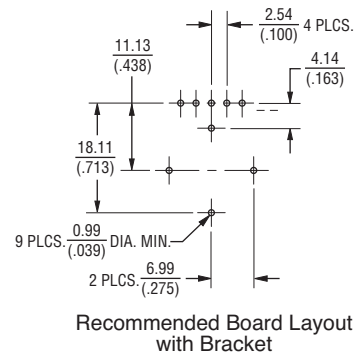

Recommended Board Layout with Bracket

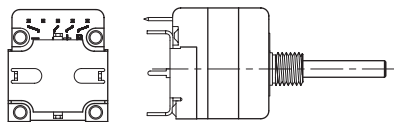

Bushing with Bracket

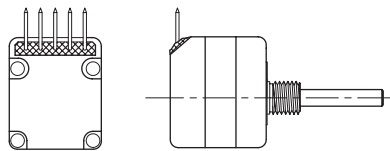

Radial Leads

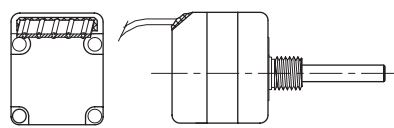

Axial Ribbon Cable Option

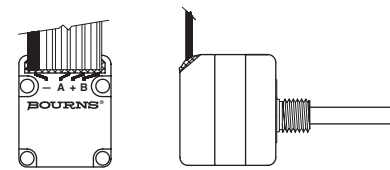

Radial Ribbon Cable Option

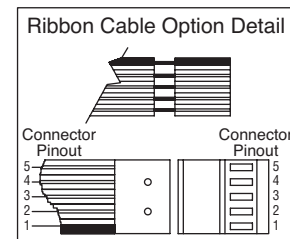

DIMENSIONS:  $\frac{\text{MM}}{\text{(INCHES)}}$